

## Timing Generator for Progressive Scan CCD Image Sensor

**Description**

The CXD2452R is a timing generator which generates the timing pulses for performing progressive scan readout for digital still cameras and personal computer image input applications using the ICX098AK CCD image sensor.

**Features**

- Base oscillation frequency 36.81MHz (2340f<sub>H</sub>)
- Monitoring readout allowed
- High-speed/low-speed electronic shutter function
- Horizontal driver for CCD image sensor
- Signal processor IC system clock generation 1170f<sub>H</sub>, 780f<sub>H</sub>
- Vertical/horizontal sync (SSG) timing generation

**Applications**

- Digital still cameras
- Personal computer image input

**Structure**

Silicon gate CMOS IC

**Pin Configuration**

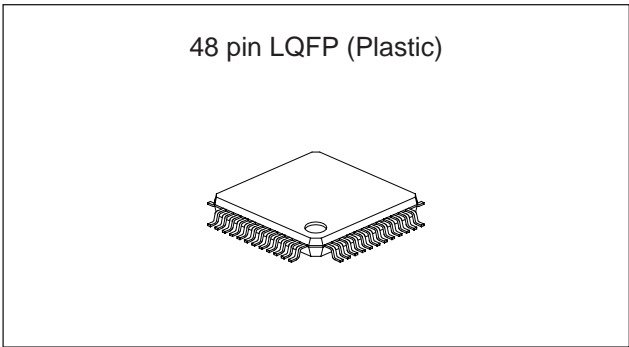
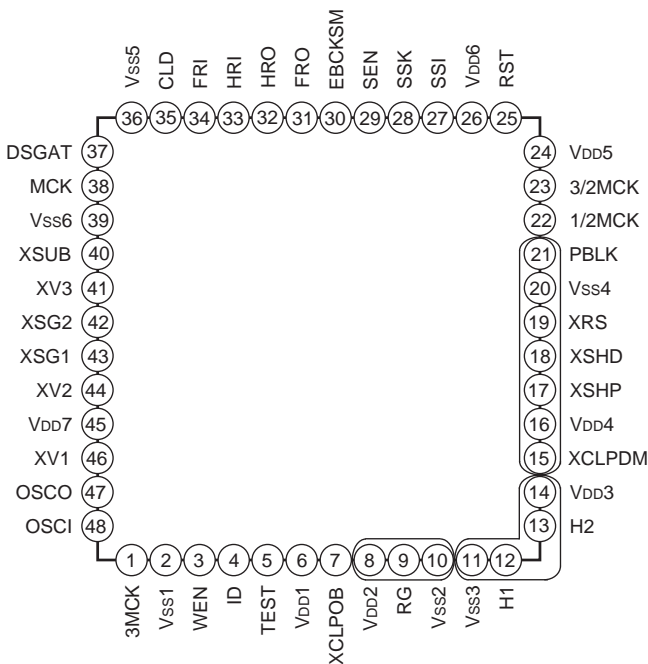

**Absolute Maximum Ratings**

• Supply voltage	V <sub>DD</sub>	V <sub>SS</sub> – 0.5 to +7.0	V
• Input voltage	V <sub>I</sub>	V <sub>SS</sub> – 0.5 to V <sub>DD</sub> + 0.5	V
• Output voltage	V <sub>O</sub>	V <sub>SS</sub> – 0.5 to V <sub>DD</sub> + 0.5	V
• Operating temperature			
	T <sub>opr</sub>	–20 to +75	°C
• Storage temperature			
	T <sub>stg</sub>	–55 to +150	°C

**Recommended Operating Conditions**

• Supply voltage			
	V <sub>DDA</sub> , V <sub>DDb</sub> , V <sub>DDc</sub> , V <sub>DDd</sub>	3.0 to 3.6	V
• Operating temperature			
	T <sub>opr</sub>	–20 to +75	°C

**Applicable CCD Image Sensors**

ICX098AK (Type 1/4 CCD)

\*Groups of pins enclosed in the figure indicate sections for which power supply separation is possible.

Sony reserves the right to change products and specifications without prior notice. This information does not convey any license by any implication or otherwise under any patents or other right. Application circuits shown, if any, are typical examples illustrating the operation of the devices. Sony cannot assume responsibility for any problems arising out of the use of these circuits.

Block Diagram

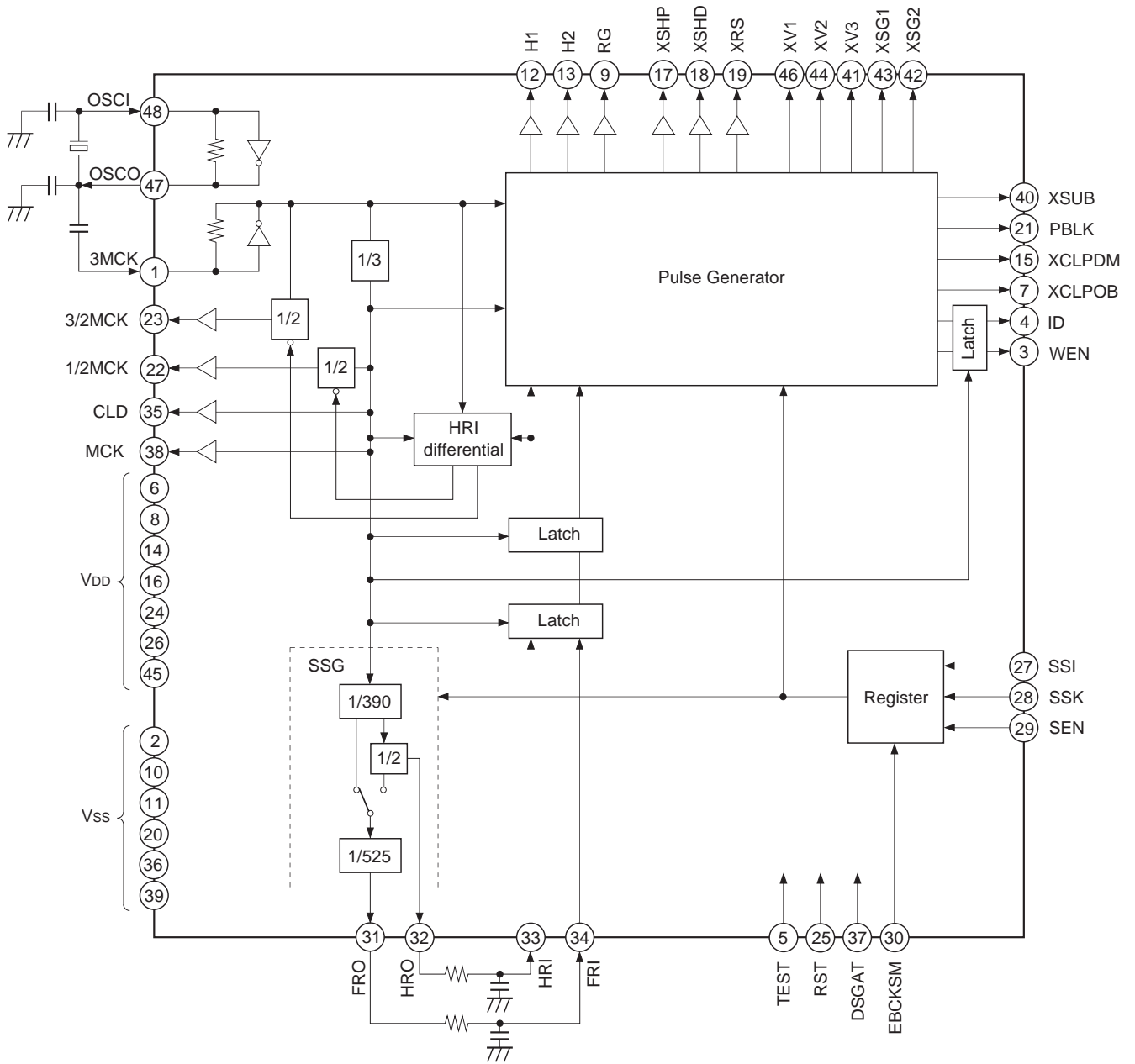

## Pin Description

Pin No.	Symbol	I/O	Description
1	3MCK	I	Internal main clock. (2340f <sub>H</sub> )
2	V <sub>SS1</sub>	—	GND
3	WEN	O	Memory write timing. Stop control possible using the serial interface data.
4	ID	O	Vertical direction line identification pulse output. Stop control possible using the serial interface data.
5	TEST	I	IC test pin; normally fixed to GND. (With pull-down resistor)
6	V <sub>DD1</sub>	—	3.3V power supply. (Power supply for common logic block)
7	XCLPOB	O	CCD optical black signal clamp pulse output. Stop control possible using the serial interface data.
8	V <sub>DD2</sub>	—	3.3V power supply. (Power supply for RG)
9	RG	O	CCD reset gate pulse output. (780f <sub>H</sub> )
10	V <sub>SS2</sub>	—	GND
11	V <sub>SS3</sub>	—	GND
12	H1	O	CCD horizontal register drive clock output. (780f <sub>H</sub> )
13	H2	O	CCD horizontal register drive clock output. (780f <sub>H</sub> )
14	V <sub>DD3</sub>	—	3.3V power supply. (Power supply for H1/H2)
15	XCLPDM	O	Pulse output for dummy bit block clamp .
16	V <sub>DD4</sub>	—	3.3V power supply. (Power supply for CDS system)
17	XSHP	O	Precharge level sample-and-hold pulse output. (780f <sub>H</sub> )
18	XSHD	O	Data level sample-and-hold pulse output. (780f <sub>H</sub> )
19	XRS	O	Sample-and-hold pulse output for analog/digital conversion phase alignment. (780f <sub>H</sub> )
20	V <sub>SS4</sub>	—	GND
21	PBLK	O	Pulse output for horizontal and vertical blanking interval pulse cleaning.
22	1/2MCK	O	Horizontal direction pixel identification pulse output. Stop control possible using the serial interface data.
23	3/2MCK	—	System clock output for signal processing IC (1170f <sub>H</sub> ). Stop control possible using the serial interface data.
24	V <sub>DD5</sub>	—	3.3V power supply. (Power supply for common logic block)
25	RST	I	Internal system reset input. High: Normal status, Low: Reset status Always input one reset pulse after power-on.
26	V <sub>DD6</sub>	—	3.3V power supply. (Power supply for common logic block)
27	SSI	I	Serial interface data input for internal mode settings.
28	SSK	I	Serial interface clock input for internal mode settings.
29	SEN	I	Serial interface strobe input for internal mode settings.
30	EBCKSM	I	CHKSUM enable. (With pull-down resistor) High: Sum check invalid, Low: Sum check valid
31	FRO	O	Vertical sync signal output. Stop control possible using the serial interface data.

Pin No.	Symbol	I/O	Description
32	HRO	O	Horizontal sync signal output. Stop control possible using the serial interface data.
33	HRI	I	Horizontal sync signal input.
34	FRI	I	Vertical sync signal input.
35	CLD	O	Clock output for analog/digital conversion IC. (780fH) Phase adjustment in 60° units possible using the serial interface data.
36	Vss5	—	GND
37	DSGAT	I	Control input used to stop pulse generation for CCD image sensor, sample-and-hold IC and analog/digital conversion IC. High: Normal status, Low: Stop status Controlled pulse can be changed using the serial interface data.
38	MCK	O	System clock output for signal processor IC. (780fH)
39	Vss6	—	GND
40	XSUB	O	Pulse output for electronic shutter.
41	XV3	O	CCD vertical register drive pulse output.
42	XSG2	O	CCD sensor readout pulse output.
43	XSG1	O	CCD sensor readout pulse output.
44	XV2	O	CCD vertical register drive pulse output.
45	VDD7	—	3.3V power supply. (Power supply for common logic block)
46	XV1	O	CCD vertical register drive pulse output.
47	OSCO	O	Inverter output for oscillation.
48	OSCI	I	Inverter input for oscillation.

## Electrical Characteristics

## DC Characteristics

(Within the recommended operating conditions)

Item	Pins	Symbol	Conditions	Min.	Typ.	Max.	Unit
Supply voltage 1	V <sub>DD2</sub>	V <sub>DDa</sub>		3.0	3.3	3.6	V
Supply voltage 2	V <sub>DD3</sub>	V <sub>DDb</sub>		3.0	3.3	3.6	V
Supply voltage 3	V <sub>DD4</sub>	V <sub>DDc</sub>		3.0	3.3	3.6	V
Supply voltage 4	V <sub>DD1</sub> , V <sub>DD5</sub> , V <sub>DD6</sub> , V <sub>DD7</sub>	V <sub>DDd</sub>		3.0	3.3	3.6	V
Input voltage 1*1	RST, DSGAT, SSI, SSK, SEN, FRI, HRI	V <sub>IH1</sub>		0.8V <sub>DDd</sub>			V
		V <sub>IL1</sub>				0.2V <sub>DDd</sub>	V
Input voltage 2*1 *2	EBCKSM	V <sub>IH2</sub>		0.8V <sub>DDd</sub>			V
		V <sub>IL2</sub>				0.2V <sub>DDd</sub>	V
Input voltage 3*2	TEST	V <sub>IH3</sub>		0.7V <sub>DDd</sub>			V
		V <sub>IL3</sub>				0.3V <sub>DDd</sub>	V
Output voltage 1	RG	V <sub>OH1</sub>	Feed current where I <sub>OH</sub> = -3.3mA	V <sub>DDa</sub> - 0.8			V
		V <sub>OL1</sub>	Pull-in current where I <sub>OL</sub> = 2.4mA			0.4	V
Output voltage 2	H1, H2	V <sub>OH2</sub>	Feed current where I <sub>OH</sub> = -10.4mA	V <sub>DDb</sub> - 0.8			V
		V <sub>OL2</sub>	Pull-in current where I <sub>OL</sub> = 7.2mA			0.4	V
Output voltage 3	XSHP, XSHD, XRS, PBLK, XCLPDM	V <sub>OH3</sub>	Feed current where I <sub>OH</sub> = -3.3mA	V <sub>DDc</sub> - 0.8			V
		V <sub>OL3</sub>	Pull-in current where I <sub>OL</sub> = 2.4mA			0.4	V
Output voltage 4	3/2MCK, MCK, CLD	V <sub>OH4</sub>	Feed current where I <sub>OH</sub> = -10.4mA	V <sub>DDd</sub> - 0.8			V
		V <sub>OL4</sub>	Pull-in current where I <sub>OL</sub> = 7.2mA			0.4	V
Output voltage 5	1/2MCK	V <sub>OH5</sub>	Feed current where I <sub>OH</sub> = -3.3mA	V <sub>DDd</sub> - 0.8			V
		V <sub>OL5</sub>	Pull-in current where I <sub>OL</sub> = 2.4mA			0.4	V
Output voltage 6	XV1, XV2, XV3, XSUB, XSG1, XSG2, XCLPOB, ID, WEN	V <sub>OH6</sub>	Feed current where I <sub>OH</sub> = -2.4mA	V <sub>DDd</sub> - 0.8			V
		V <sub>OL6</sub>	Pull-in current where I <sub>OL</sub> = 4.8mA			0.4	V
Output voltage 7	FRO, HRO	V <sub>OH7</sub>	Feed current where I <sub>OH</sub> = -3.6mA	V <sub>DDd</sub> - 0.8			V
		V <sub>OL7</sub>	Pull-in current where I <sub>OL</sub> = 7.2mA			0.4	V

\*1 These input pins do not have protective diodes on the internal power supply side.

\*2 These input pins have internal pull-down resistors.

\*3 The above table indicates the condition for 3.3V drive.

**Inverter I/O Characteristics for Oscillation**

(Within the recommended operating conditions)

Item	Pins	Symbol	Conditions	Min.	Typ.	Max.	Unit
Logical Vth	OSCI	LVth			V <sub>DDd</sub> /2		V
Input voltage	OSCI	V <sub>IH</sub>		0.7V <sub>DDd</sub>			V
		V <sub>IL</sub>				0.3V <sub>DDd</sub>	V
Output voltage	OSCO	V <sub>OH</sub>	Feed current where I <sub>OH</sub> = -6.0mA	V <sub>DDd</sub> /2			V
		V <sub>OL</sub>	Pull-in current where I <sub>OL</sub> = 6.0mA			V <sub>DDd</sub> /2	V
Feedback resistor	OSCI, OSCO	RFB	V <sub>IN</sub> = V <sub>DDd</sub> or V <sub>SS</sub>	500k	2M	5M	Ω
Oscillation frequency	OSCI, OSCO	f		20		50	MHz

**Inverter Input Characteristics for Base Oscillation Clock Duty Adjustment**

(Within the recommended operating conditions)

Item	Pins	Symbol	Conditions	Min.	Typ.	Max.	Unit
Logical Vth	3MCK	LVth			V <sub>DDd</sub> /2		V
Input voltage		V <sub>IH</sub>		0.7V <sub>DDd</sub>			V
		V <sub>IL</sub>				0.3V <sub>DDd</sub>	V
Input amplitude		V <sub>IN</sub>	f <sub>max</sub> 50MHz sine wave	0.3			V <sub>p-p</sub>

\*1 Input voltage is the input voltage characteristics for direct input from an external source. Input amplitude is the input amplitude characteristics in the case of input through capacitor.

AC Characteristics

1) AC characteristics between the serial interface clocks

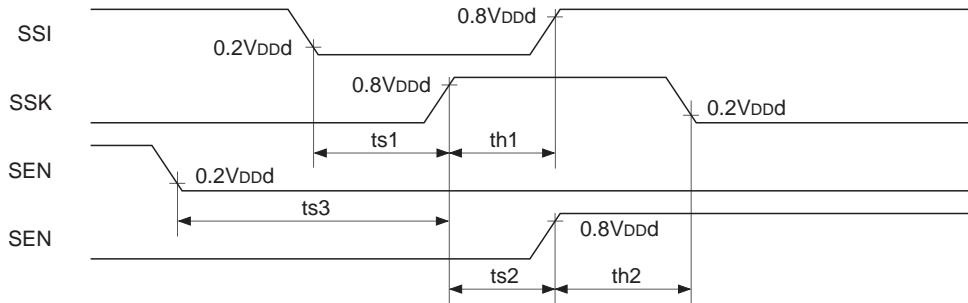

(Within the recommended operating conditions)

Symbol	Definition	Min.	Typ.	Max.	Unit
ts1	SSI setup time, activated by the rising edge of SSK	20			ns
th1	SSI hold time, activated by the rising edge of SSK	20			ns
ts2	SSK setup time, activated by the rising edge of SEN	20			ns
th2	SSK hold time, activated by the rising edge of SEN	20			ns
ts3	SEN setup time, activated by the rising edge of SSK	20			ns

2) Serial interface clock internal loading characteristics

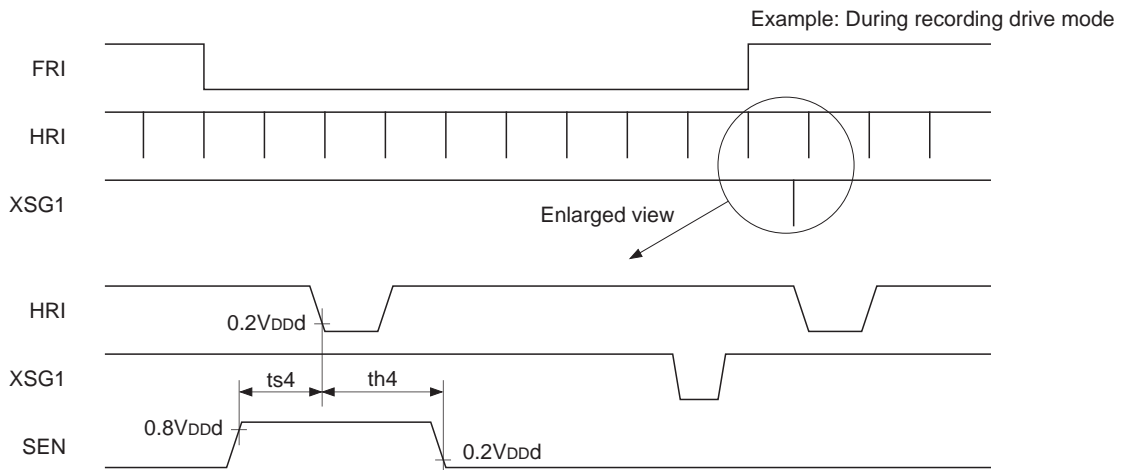

**Note)** Be sure to maintain a constantly high SEN logic level near the HRI fall immediately before XSG1 generation.

(Within the recommended operating conditions)

Symbol	Definition	Min.	Typ.	Max.	Unit
ts4	SEN setup time, activated by the falling edge of HRI	0			ns
th4	SEN hold time, activated by the falling edge of HRI	0			ns

### 3) Serial interface clock output variation characteristics

Normally, the serial interface data is loaded to the CXD2452R at the timing shown in 2) above. However, one exception to this is when the data such as SSGSEL and STB is loaded to the CXD2452R and controlled at the rising edge of SEN. For STB, see control data **D62** to **D63** STB in “Description of Operation”.

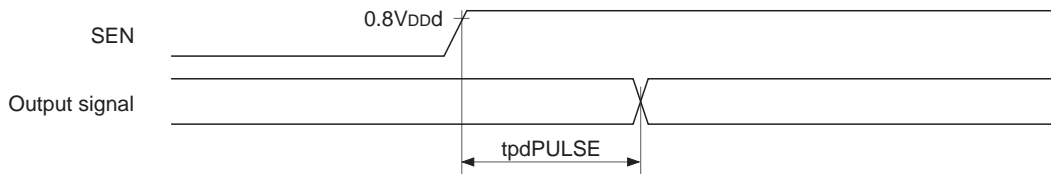

(Within the recommended operating conditions)

Symbol	Definition	Min.	Typ.	Max.	Unit
tpdPULSE	Output signal delay, activated by the rising edge of SEN	5		100	ns

### 4) RST loading characteristics

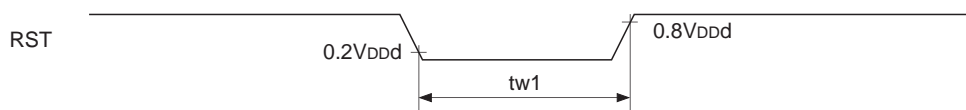

(Within the recommended operating conditions)

Symbol	Definition	Min.	Typ.	Max.	Unit
tw1	RST pulse width	35			ns

### 5) Phase identification characteristics using FRI and HRI input

When the HRI logic level is low tpd1 after the falling edge of FRI

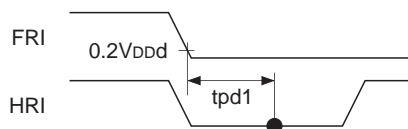

The field is identified as an **ODD field**.

When the HRI logic level is high tpd1 after the falling edge of FRI

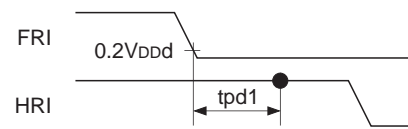

The field is identified as an **EVEN field**.

(Within the recommended operating conditions)

Symbol	Definition	Min.	Typ.	Max.	Unit
tpd1	Field identification clock phase, activated by the falling edge of FRI	1100		1300	ns



6) FRI and HRI loading characteristics

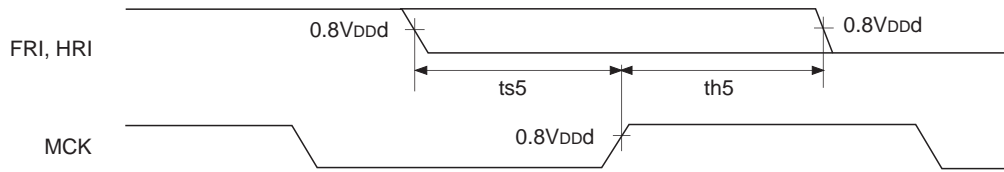

MCK load capacitance = 10pF

(Within the recommended operating conditions)

Symbol	Definition	Min.	Typ.	Max.	Unit
ts5	FRI and HRI setup time, activated by the rising edge of MCK	10			ns
th5	FRI and HRI hold time, activated by the rising edge of MCK	0			ns

7) Output timing characteristics using DSGAT

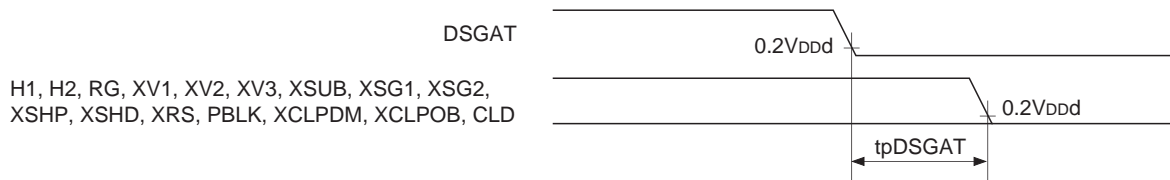

H1 and H2 load capacitance = 100pF, RG load capacitance = 20pF, XV1, XV2, XV3, XSG1, XSG2, XSUB, XSHP, XSHD, XRS, PBLK, XCLPDM, XCLPOB and CLD load capacitance = 10pF

(Within the recommended operating conditions)

Symbol	Definition	Min.	Typ.	Max.	Unit
tpDSGAT	Time until the above outputs go low after the fall of DSGAT			100	ns

8) Output variation characteristics

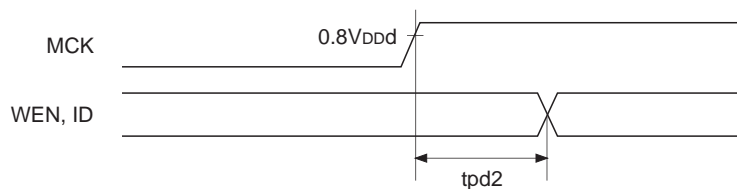

WEN and ID load capacitance = 10pF

(Within the recommended operating conditions)

Symbol	Definition	Min.	Typ.	Max.	Unit
tpd2	Time until the above outputs change after the rise of MCK	20		40	ns

9) H1 and RG waveform characteristics

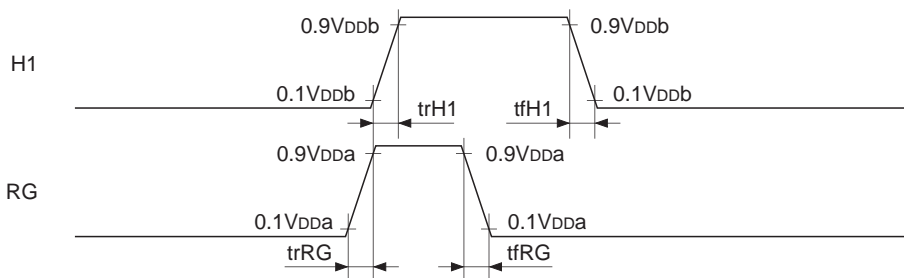

$V_{Ddb} = 3.3V$ ,  $T_{opr} = 25^{\circ}C$ , H1 and H2 load capacitance = 100pF, RG load capacitance = 20pF

(Within the recommended operating conditions)

Symbol	Definition	Min.	Typ.	Max.	Unit
trH1	H1 rise time		10		ns
tfH1	H1 fall time		10		ns
trRG	RG rise time		3		ns
tfRG	RG fall time		3		ns

10) I/O pin capacitance

(Within the recommended operating conditions)

Symbol	Definition	Min.	Typ.	Max.	Unit
C <sub>IN</sub>	Input pin capacitance			9	pF
C <sub>OUT</sub>	Output pin capacitance			11	pF
C <sub>I/O</sub>	I/O pin capacitance			11	pF

**Description of Operation**

All pulses output from the CXD2452R are controlled by the RST and DSGAT pins and by the serial interface data shown below. The details of control by the serial interface data and a description of operation are as follows.

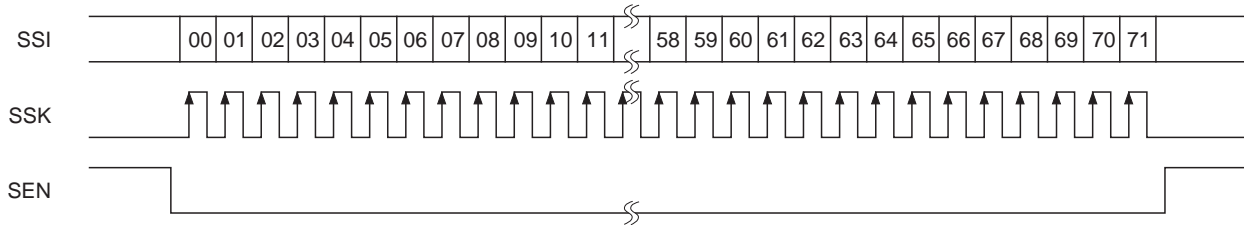

The CXD2452R basically loads and reflects the serial interface data sent in the above format in the readout portion at the falling edge of HRI. Here, readout portion specifies the horizontal interval during which XSG1 rises.

There are two types of serial interface data: drive control data and phase adjustment data. Hereafter, these data are distinguished by referring to the former as control data and the latter as adjustment data.

An example of the initialization data for the CXD2452R control data is shown below. This data is based on the Application Circuit Block Diagram, so care should be taken as there are some differences from the RST pin initialization data. Concretely, the internal SSG operates, the XCLPOB and ID pulses are generated, and the 3/2 MCK pulse is stopped. This data shows the values when the EBCKSM pin is low and [D64] to [D71] CHKSUM is valid.

MSB															LSB	
D71	D70	D69	D68	D67	D66	D65	D64	D63	D62	D61	D60	D59	D58	D57	D56	
1	0	1	0	1	1	0	1	0	0	0	0	0	0	0	1	0
MSB															LSB	
D55	D54	D53	D52	D51	D50	D49	D48	D47	D46	D45	D44	D43	D42	D41	D40	
1	1	0	1	0	0	0	0	0	0	0	0	0	0	0	0	0
MSB															LSB	
D39	D38	D37	D36	D35	D34	D33	D32	D31	D30	D29	D28	D27	D26	D25	D24	
0	0	0	0	0	0	0	0	0	0	0	0	0	0	0	0	0
MSB															LSB	
D23	D22	D21	D20	D19	D18	D17	D16	D15	D14	D13	D12	D11	D10	D09	D08	
0	0	0	0	0	0	0	0	0	0	0	0	0	0	0	0	0
MSB							LSB									
D07	D06	D05	D04	D03	D02	D01	D00									
1	0	0	0	0	0	0	1									

The adjustment data does not normally need to be set. However, when adjustment is difficult due to the system configuration or for other reasons, the data considered most appropriate at that time should be set as the initialization data.

## Control Data

Data	Symbol	Function	Data = 0	Data = 1	When a reset
D00 to D07	CHIP	Chip switching	See <a href="#">D00</a> to <a href="#">D07</a> CHIP.		All 0
D08 to D15	CTGRY	Category switching	See <a href="#">D08</a> to <a href="#">D15</a> CTGRY.		All 0
D16 to D17	SMD	Electronic shutter mode setting	See <a href="#">D16</a> to <a href="#">D35</a> Electronic shutter mode.		All 0
D18 to D25	Shut.FRM	Electronic shutter vertical interval setting	See <a href="#">D16</a> to <a href="#">D35</a> Electronic shutter mode.		All 0
D26 to D35	Shut.HD	Electronic shutter horizontal interval setting	See <a href="#">D16</a> to <a href="#">D35</a> Electronic shutter mode.		All 0
D36 to D47	—	—	—	—	All 0
D48	EXPOSE	Recording exposure setting switching	OFF	ON	0
D49 to D50	—	—	—	—	All 0
D51	PSMT	Drive mode switching	Monitoring	Recording	0
D52	SSGSEL	Internal SSG operation switching	OFF	ON	0
D53	WENSEL	WEN pulse operation switching	ON	OFF	0
D54	CLPSEL	XCLPOB pulse operation switching	OFF	ON	0
D55	IDSEL	ID pulse operation switching	OFF	ON	0
D56	HMCKSEL	1/2MCK pulse operation switching	OFF	ON	0
D57	TMCKSEL	3/2MCK pulse operation switching	ON	OFF	0
D58	HMCKREV	1/2MCK pulse reset polarity switching	Positive polarity	Negative polarity	0
D59	TMCKREV	2/3MCK pulse reset polarity switching	Negative polarity	Positive polarity	0
D60 to D61	DSG	Pulse generation control	See <a href="#">D60</a> to <a href="#">D61</a> DSG table.		All 0
D62 to D63	STB	IC pin status control	See <a href="#">D62</a> to <a href="#">D63</a> STB table.		All 0
D64 to D71	CHKSUM	Check sum bit	See <a href="#">D64</a> to <a href="#">D71</a> CHKSUM.		All 0

**Detailed Description of Each Data**

**D00 to D07 CHIP**

The serial interface data is loaded to the CXD2452R when D00 and D07 are 1. However, this assumes that either the EBCKSM pin is low and D64 to D71 CHKSUM is satisfied or the EBCKSM pin is high.

MSB								LSB	Function
D07	D06	D05	D04	D03	D02	D01	D00		
1	0	0	0	0	0	0	1	Loading to the CXD2452R	

Note that when SEN is shared with other ICs and identification is performed using CHIP-ID, the CXD2452R data must be positioned immediately before the load timing, that is to say at the very end.

**D08 to D15 CTGRY**

Of the data provided to the CXD2452R by the serial interface, the CXD2452R loads D16 and subsequent data to the control register side when D08 is 0, and to the adjustment register side when D08 is 1. However, this assumes that the CXD2452R is selected by CHIP and that either the EBCKSM pin is low and D64 to D71 CHKSUM is satisfied or the EBCKSM pin is high.

MSB								LSB	Function
D15	D14	D13	D12	D11	D10	D09	D08		
0	0	0	0	0	0	0	0	Loading to the control register side	
0	0	0	0	0	0	0	1	Loading to the adjustment register side	

Note that the CXD2452R cannot apply both categories simultaneously during the same vertical interval. Also, care should be taken as the data is overwritten even if the same category is applied.

**D16 to D35 Electronic shutter mode**

The CXD2452R's electronic shutter mode can be switched as follows by SMD D16 to D17. Handling of the data from D18 to D35 differs according to the mode, and is explained in detail below.

D17	D16	Description of operation
X	0	XSUB stopped mode
0	1	High-speed/low-speed shutter mode
1	1	HTSG control mode

The electronic shutter data is expressed as shown in the table below using Shut.HD as an example.

MSB						LSB			
D35	D34	D33	D32	D31	D30	D29	D28	D27	D26
0	1	1	1	0	0	0	0	1	1
	↓			↓				↓	
	1			C				3	

→ Shut.HD is expressed as 1C3h.

**[XSUB stopped mode]**

During this mode, the data from D18 to D35 is invalid. The shutter speed is 1/60s during monitoring drive mode, and 1/30s during recording drive mode.

**[High-speed/low-speed shutter mode]**

During this mode, the data has the following meanings.

Symbol	Data	Description
Shut.FRM	D18 to D25	Shutter speed data (number of vertical intervals) specification
Shut.HD	D26 to D35	Shutter speed data (number of horizontal intervals) specification

The CXD2452R does not distinguish between the high-speed shutter and low-speed shutter modes. The interval during which Shut.FRM and Shut.HD are specified together is the shutter speed. At this time, Shut.FRM controls the XSG1, XSG2 output, and Shut.HD controls the XSUB output. Concretely, when specifying high-speed shutter, Shut.FRM is set to 00h. (See the figure.) During low-speed shutter, or in other words when Shut.FRM is set to 01h or higher, the serial interface data is not loaded until this interval is finished.

However, care should be taken as the vertical interval indicated here is set in 1/60s units when the drive mode is monitoring drive mode and 1/30s units during recording drive mode.

For monitoring drive mode, care should be taken that shut.HD value is offset. This is because the same exposure time can be obtained for the same shut.HD data without depending on drive mode basically for high-speed shutter.

Formula for calculating the electronic shutter speed: [Shut.FRM/Shut.HD] (unit:  $\mu$ s)

**Monitoring drive mode:**

$$T = \text{Shut.FRM} * 1.66834 * 10^4 + \{(20\text{Ch} - \text{Shut.HD}) * 780 + 447\} * 81.5 * 10^{-3} \quad (107\text{h} \leq \text{Shut.HD} \leq 20\text{Ch})$$

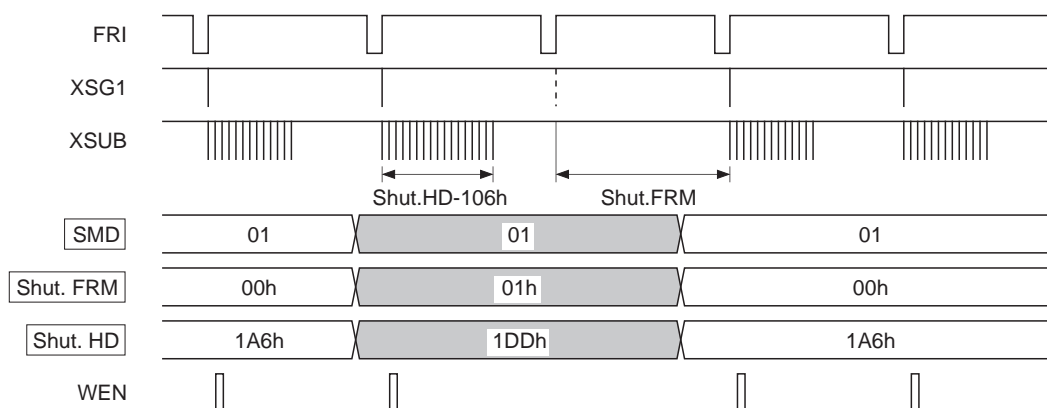

**During monitoring drive mode/low-speed shutter mode**

**Recording drive mode:**

$$T = \text{Shut.FRM} * 3.33667 * 10^4 + \{(20\text{Ch} - \text{Shut.HD}) * 780 + 447\} * 81.5 * 10^{-3} \quad (000\text{h} \leq \text{Shut.HD} \leq 20\text{Ch})$$

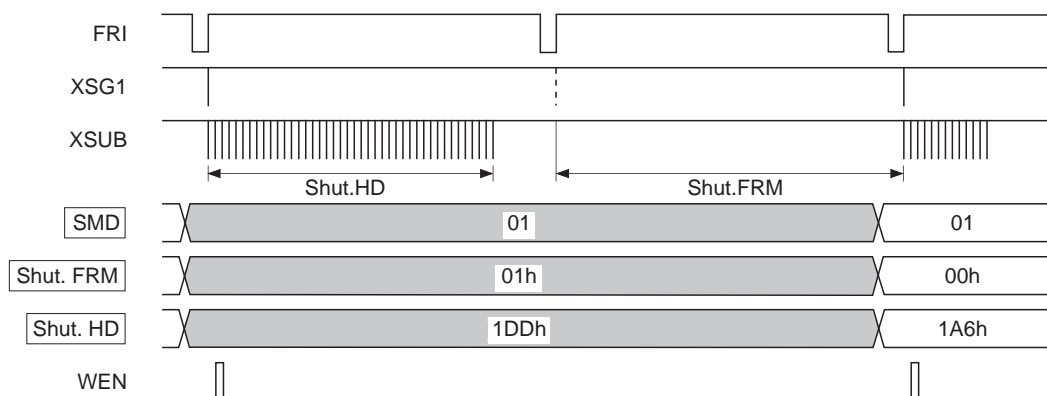

**During recording drive mode/low-speed shutter mode**

**Electronic shutter speed table [Shut.FRM/Shut.HD]**

Shut.FRM	Shut.HD	Shutter speed (s)	Calculation results (s)	Shut.FRM	Shut.HD	Shutter speed (s)	Calculation results (s)
00h	20Ch	1/27000	1/27450	00h	107h*1	1/60	1/60
00h	20Bh	1/10000	1/10000	01h	20Ch	1/60*2	1/60
00h	209h	1/4500	1/4403	01h	1D8h	1/50*2	1/50
00h	205h	1/2000	1/2077	02h	20Ch	1/30*2	1/30
00h	1FDh	1/1000	1/1010	07h	18Bh	1/8*2	1/8
00h	1EDh	1/500	1/498	09h	109h	1/6*2	1/6
00h	1CEh	1/250	1/251	00h	0D2h	1/50*3	1/50
00h	18Fh	1/125	1/125	00h	083h	1/40*3	1/40
00h	16Fh	1/100	1/100	00h	000h	1/30*3	1/30

\*1 One XSUB pulse is generated for odd fields and two for even fields.

\*2 These are the settings during monitoring drive mode.

\*3 These can only be specified during recording drive mode.

**Note)** Input prohibited data:

Monitoring drive mode

000h to 106h

Recording drive mode and monitoring drive mode

20Dh to 3FFh

**[HTSG control mode]**

During this mode, the data from **D18** to **D35** is invalid. The shutter speed is the value obtained by adding the shutter speed specified in the preceding vertical interval to the vertical period during which XSG1 (and XSG2) is stopped as shown in the figure.

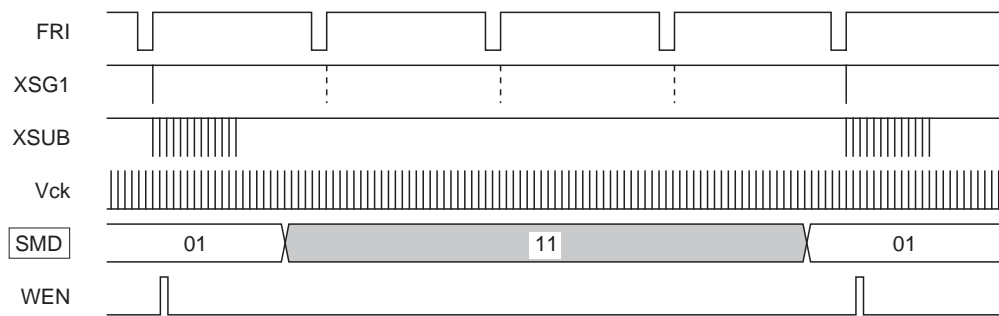

**During HTSG control mode**

**D48 EXPOSE**

- 0: No operation
- 1: XSUB for recording exposure is generated.

This control specification is such that one XSUB pulse is always generated during the horizontal interval immediately following the readout portion even if the electronic shutter speed is set to 1/60s (SMD = 00). This mode is closely related to **D51 PSMT**, so see **D51** regarding the control.

**D51 PSMT**

- 0: Driving is controlled in accordance with monitoring drive mode under the assumption that vertical/horizontal sync signals are input.
- 1: Driving is controlled in accordance with recording drive mode under the assumption that vertical/horizontal sync signals are input.

See the timing charts for the vertical/horizontal sync signals in accordance with each mode.

Note that when switching from monitoring drive to recording drive mode, the pixels decimated thus far must be cleaned.

Concretely, this operation is supported by generating XSUB, but the CXD2452R facilitates this control by using **D48 EXPOSE**. (See the figure.)

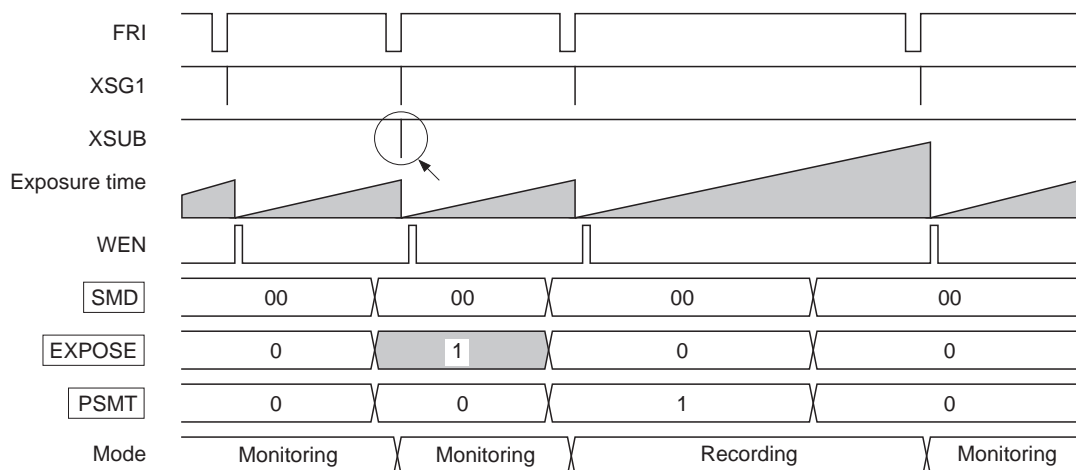

**Image of switching from monitoring drive mode to recording drive mode**

**D52 SSGSEL**

- 0: Internal SSG functions are stopped.
- 1: Internal SSG functions operate, and FRO and HRO are generated.

When generation is stopped, these pulses are fixed low.

**D53 WENSEL**

- 0: WEN is generated.
- 1: WEN generation is stopped.

When generation is stopped, operation is the same as for **D52 SSGSEL**.



**D54 CLPSEL**

0: XCPOB generation is stopped.

1: XCPOB is generated.

When generation is stopped, operation is the same as for **D52** SSGSEL.

**D55 IDSEL**

0: ID generation is stopped.

1: ID is generated.

When generation is stopped, operation is the same as for **D52** SSGSEL.

**D56 HMCKSEL**

0: 1/2MCK generation is stopped.

1: 1/2MCK is generated.

When generation is stopped, operation is the same as for **D52** SSGSEL.

**D57 TMCKSEL**

0: 3/2MCK is generated.

1: 3/2MCK generation is stopped.

When generation is stopped, operation is the same as for **D52** SSGSEL.

**D58 HMCKREV**

0: 1/2MCK reset when positive polarity.

1: 1/2MCK reset when negative polarity.

**D59 HMCKREV**

0: 3/2MCK reset when negative polarity.

1: 3/2MCK reset when positive polarity.

**D60 to D61 DSG**

The CXD2452R can stop control to the CCD pulses and pulses for the sample-and-hold and analog/digital conversion ICs by setting the DSGAT pin low. Conversely, when the DSGAT pin is set high, the controlled pulses can be switched as follows using the serial interface data.

D61	D60	Operating mode
0	0	No control performed
0	1	CCD pulse control
1	0	Sample-and-hold and analog/digital conversion IC pulse control
1	1	CCD pulse and sample-and-hold and analog/digital conversion IC pulse control

Here, CCD pulses refer to the H1, H2, RG, XV1, XV2, XV3, XSUB, XSG1 and XSG2 pulses. Sample-and-hold and analog/digital conversion IC pulses refer to the XSHP, XSHD, XRS, PBLK, XCLPOB, XCLPDM and CLD pulses.

See 7) Output timing characteristics using DSGAT of "AC Characteristics" for the stop control status of each pulse.

**D62 to D63 STB**

This switches the operating mode as shown below. However, the IC pin status control bit is loaded to the CXD2452R and controlled immediately at the rise of the SEN input.

D63	D62	Symbol	Operating mode
X	0	CAMERA	Normal operation mode
0	1	SLEEP	Sleep mode*1
1	1	STNBY	Standby mode

\*1 Mode for the status which does not require CCD drive when playing back recorded data within the system.

The pin status during each mode is shown in the table below.

Pin	Symbol	CAMERA	SLEEP	STNBY	Pin	Symbol	CAMERA	SLEEP	STNBY
1	3MCK	ACT	ACT	ACT	25	RST	ACT	ACT	ACT
2	Vss1	—			26	VDD6	—		
3	WEN	ACT	L	L	27	SSI	ACT	ACT	ACT
4	ID	ACT	L	L	28	SSK	ACT	ACT	ACT
5	TEST	—			29	SEN	ACT	ACT	ACT
6	VDD1	—			30	EBCKSM	ACT	ACT	ACT
7	XCLPOB	ACT	L	L	31	FRO	ACT	ACT	L
8	VDD2	—			32	HRO	ACT	ACT	L
9	RG	ACT	L	L	33	HRI	ACT	ACT	ACT
10	Vss2	—			34	FRI	ACT	ACT	ACT
11	Vss3	—			35	CLD	ACT	L	L
12	H1	ACT	L	L	36	Vss5	—		
13	H2	ACT	L	L	37	DSGAT	ACT	ACT	ACT
14	VDD3	—			38	MCK	ACT	ACT	L
15	XCLPDM	ACT	L	L	39	Vss6	—		
16	VDD4	—			40	XSUB	ACT	L	L
17	XSHP	ACT	L	L	41	XV3	ACT	L	L
18	XSHD	ACT	L	L	42	XSG2	ACT	L	L
19	XRS	ACT	L	L	43	XSG1	ACT	L	L
20	Vss4	—			44	XV2	ACT	L	L
21	PBLK	ACT	L	L	45	VDD7	—		
22	1/2MCK	ACT	L	L	46	XV1	ACT	L	L
23	3/2MCK	ACT	ACT	L	47	OSCO	ACT	ACT	ACT
24	VDD5	—			48	OSCI	ACT	ACT	ACT

**Note)** ACT means that the circuit is operating. L indicates a low output level in the controlled status.

**D64 to D71 CHKSUM**

This is the check sum bit. Apply the data shown below.

	MSB							LSB	
	D07	D06	D05	D04	D03	D02	D01	D00	
	D15	D14	D13	D12	D11	D10	D09	D08	
	D23	D22	D21	D20	D19	D18	D17	D16	
	D31	D30	D29	D28	D27	D26	D25	D24	
	D39	D38	D37	D36	D35	D34	D33	D32	
	D47	D46	D45	D44	D43	D42	D41	D40	
	D55	D54	D53	D52	D51	D50	D49	D48	
	D63	D62	D61	D60	D59	D58	D57	D56	
+)	D71	D70	D69	D68	D67	D66	D65	D64	→ CHKSUM
	0	0	0	0	0	0	0	0	→ Reflected when the total is 0.

**Chart-1 Vertical Direction Timing Chart**      **MODE** (Base oscillation frequency: 2340fH)      **Applicable CCD image sensor**  
 Recording drive mode      ICX098AK

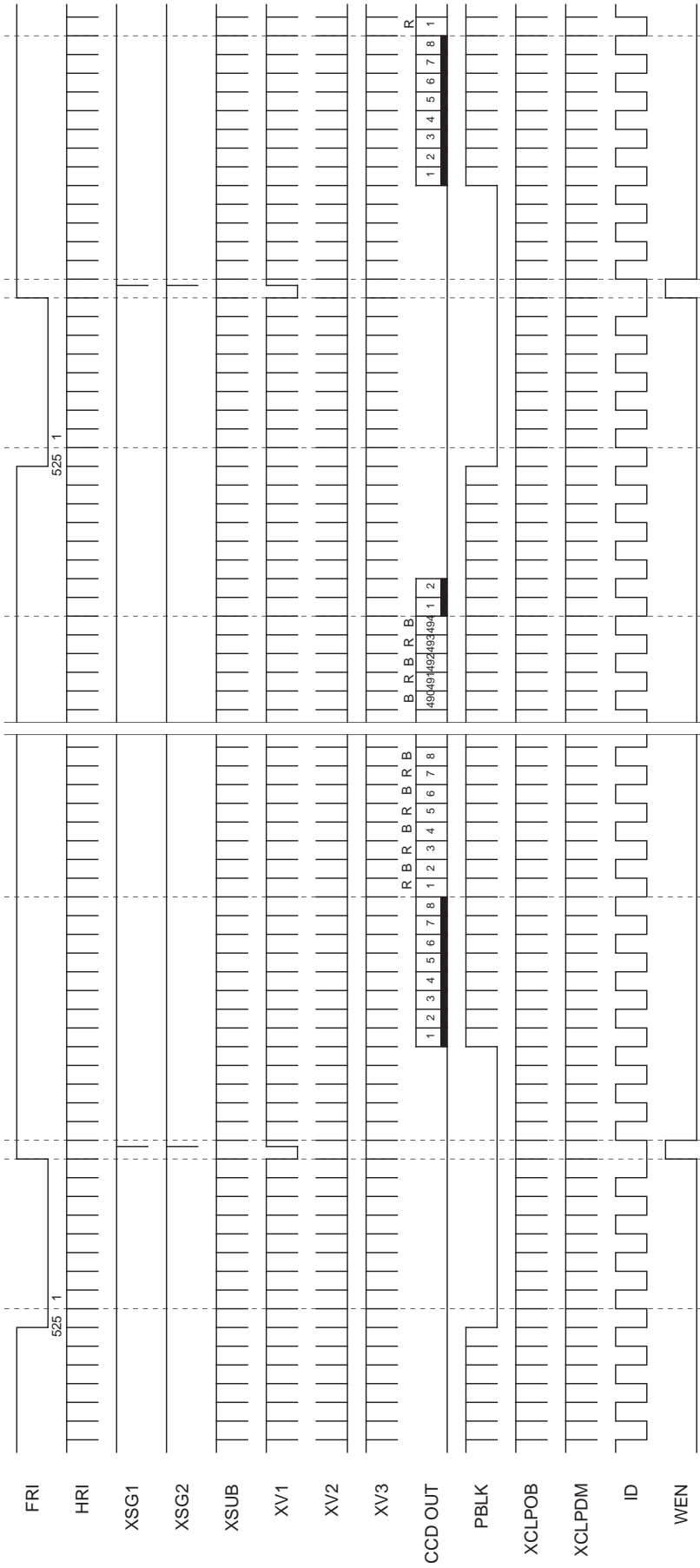

\* The number of XSUB pulses is determined by the serial interface data. This chart shows the case where Shut.HD = 20Ch and XSUB pulses are generated over the entire horizontal interval.  
 \* In addition to the phase relationship between FRI and HRI shown above, the phases may also be offset by 1/2 horizontal interval. In any case, the readout interval is the 9th HRI fall counted from the fall of FRI.  
 \* Note that R and B of CCDOUT indicate lines containing these components, and do not mean the lead pixel component of that line.

**Chart-2 Vertical Direction Timing Chart** **MODE** (Base oscillation frequency: 2340fH) **Applicable CCD image sensor**  
 ICX098AK  
 Monitoring drive mode

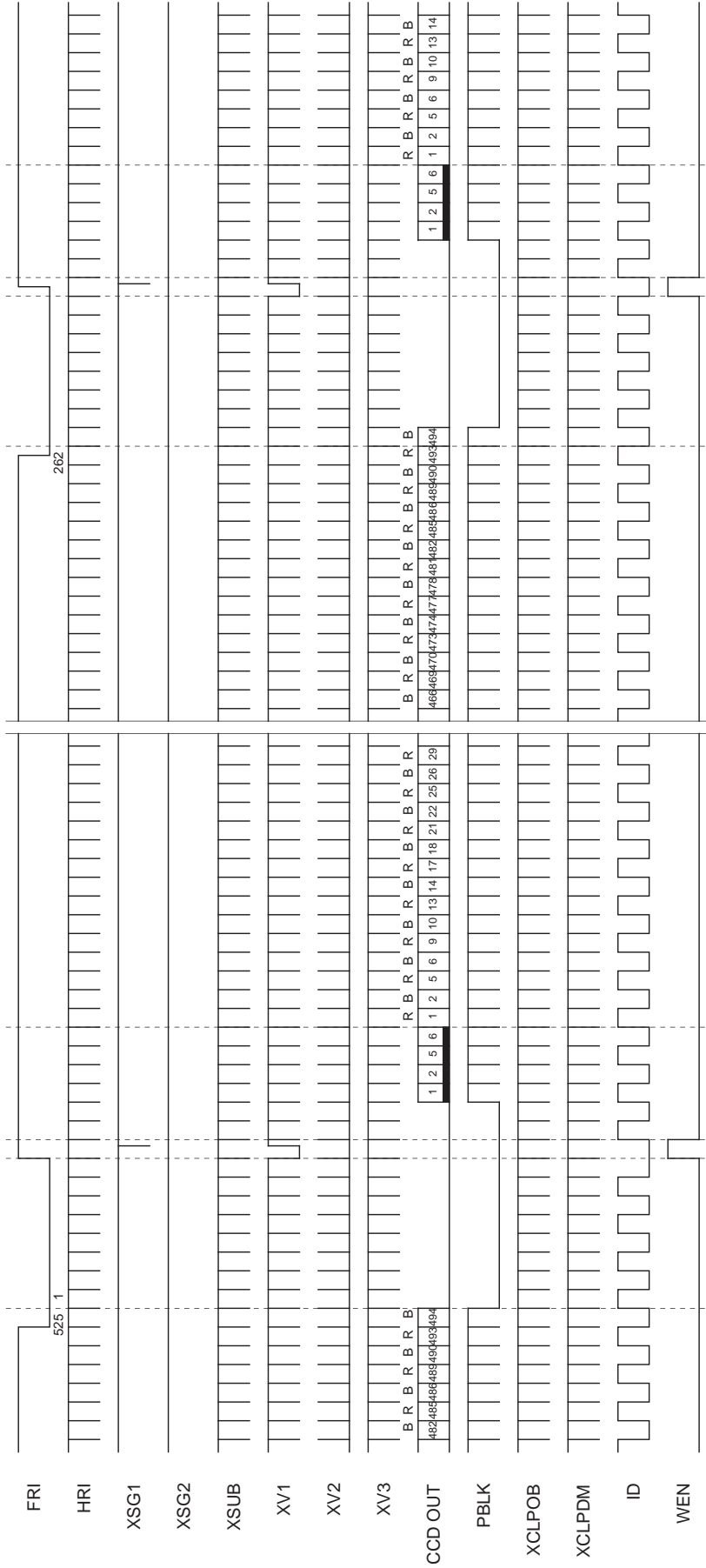

\* The number of XSUB pulses is determined by the serial interface data. This chart shows the case where Shut.HD = 20Ch and XSUB pulses are generated over the entire horizontal interval.  
 \* Note that R and B of CCDOUT indicate lines containing these component, and do not mean the lead pixel component of that line.

**Chart-3 Horizontal Direction Timing Chart** **MODE (Base oscillation frequency: 2340fH)** **Applicable CCD image sensor**  
 Recording drive mode ICX098AK

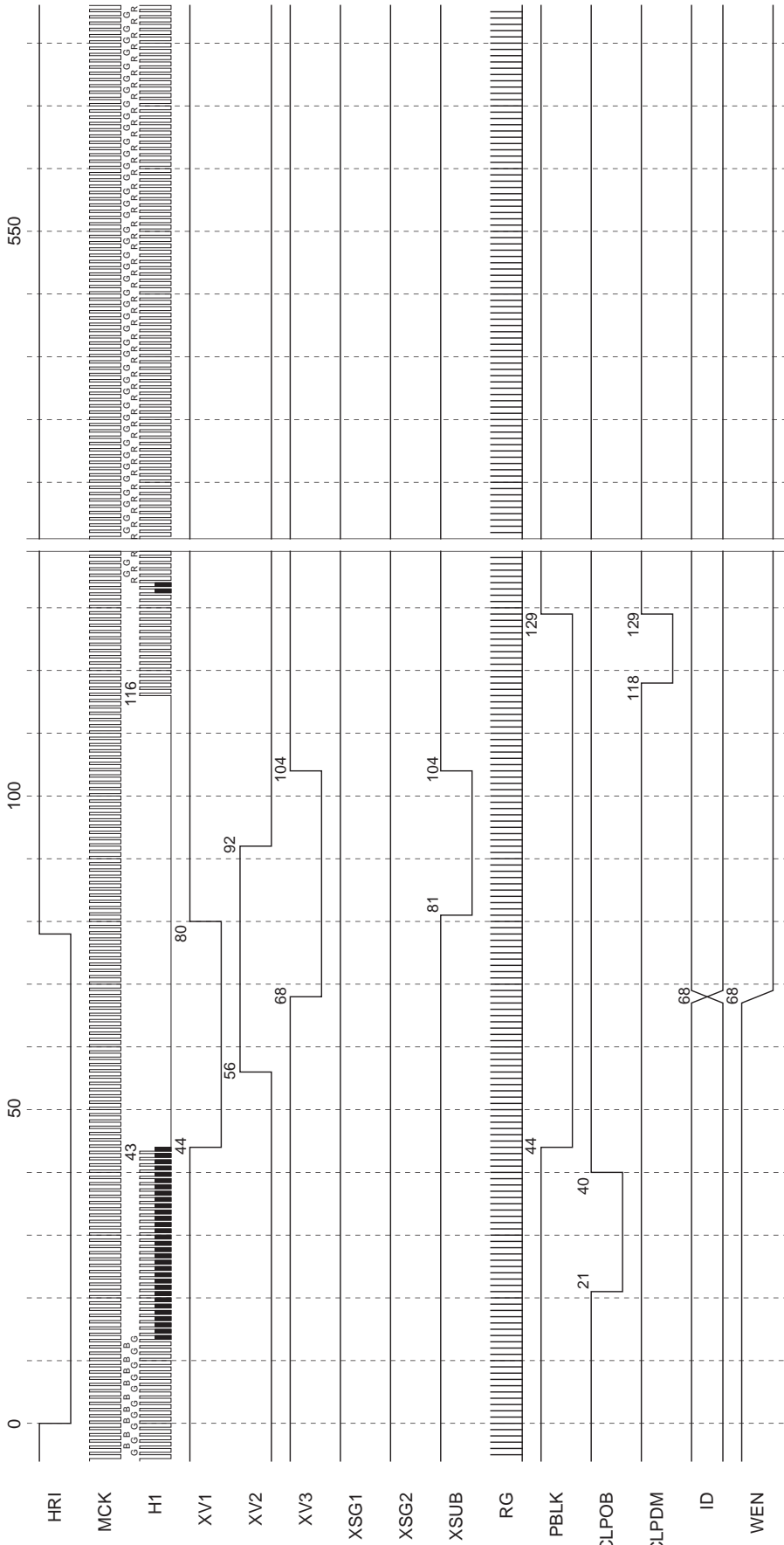

- \* The HRI of this chart is equivalent to HRI' of Chart-7. This HRI indicates a timing that the CXD2452R takes in actually.
- \* The numbers at the output pulse transition points indicate the count at the MCK (780fH) rise from the fall of HRI.
- \* The HRI fall interval should be between 3.6 to 9.4µs. This chart shows an interval of 78ck (6.3µs).
- \* XSUB is output at the timing shown above when specified by the serial interface data.
- \* The ID transition timing is synchronized with the fall of XV3.
- \* WEN is output during the horizontal interval shown in Chart-1. The transition timing is the same as that for ID.
- \* R, G and B of H1 indicate the output pixel color. In addition to the lines starting from R and G shown above, there are also lines starting from G and B.

**Chart-4 Horizontal Direction Timing Chart** **MODE** (Base oscillation frequency: 2340fH) **Applicable CCD image sensor**  
 ICX098AK  
 Recording drive mode (readout portion)

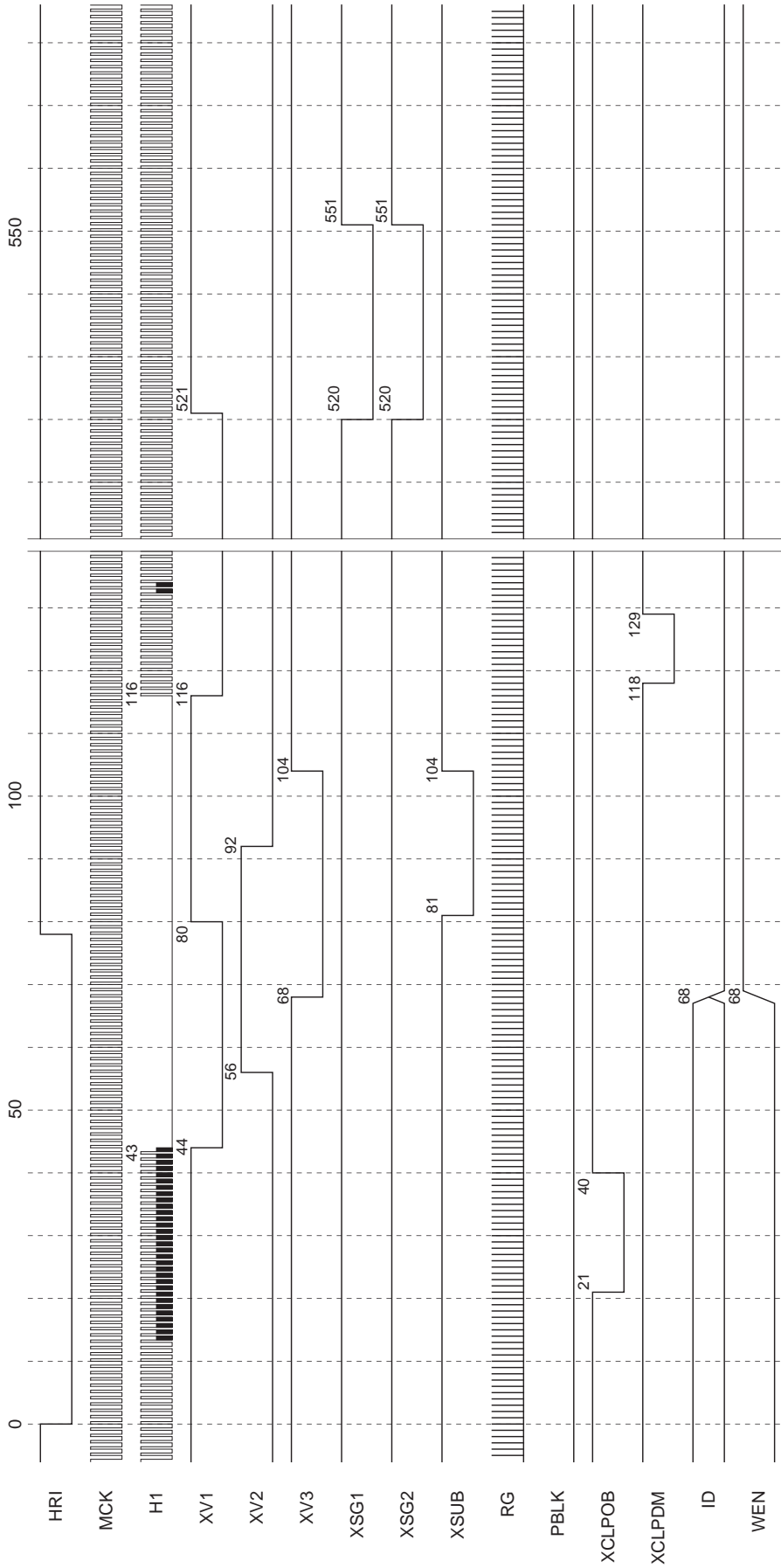

- \* The HRI of this chart is equivalent to HRI' of Chart-7. This HRI indicates a timing that the CXD2452R takes in actually.
- \* The numbers at the output pulse transition points indicate the count at the MCK (780fH) rise from the fall of HRI.
- \* The HRI fall interval should be between 3.6 to 9.4μs. This chart shows an interval of 78ck (6.3μs).
- \* XSUB is output at the timing shown above when specified by the serial interface data.
- \* The ID transition timing is synchronized with the fall of XV3. ID is reset low at this timing during the readout horizontal interval.
- \* WEN is output during the horizontal interval shown in Chart-1. The transition timing is the same as that for ID.

**Chart-5 Horizontal Direction Timing Chart**

Applicable CCD image sensor  
ICX098AK

MODE (Base oscillation frequency: 2340fH)  
Monitoring drive mode

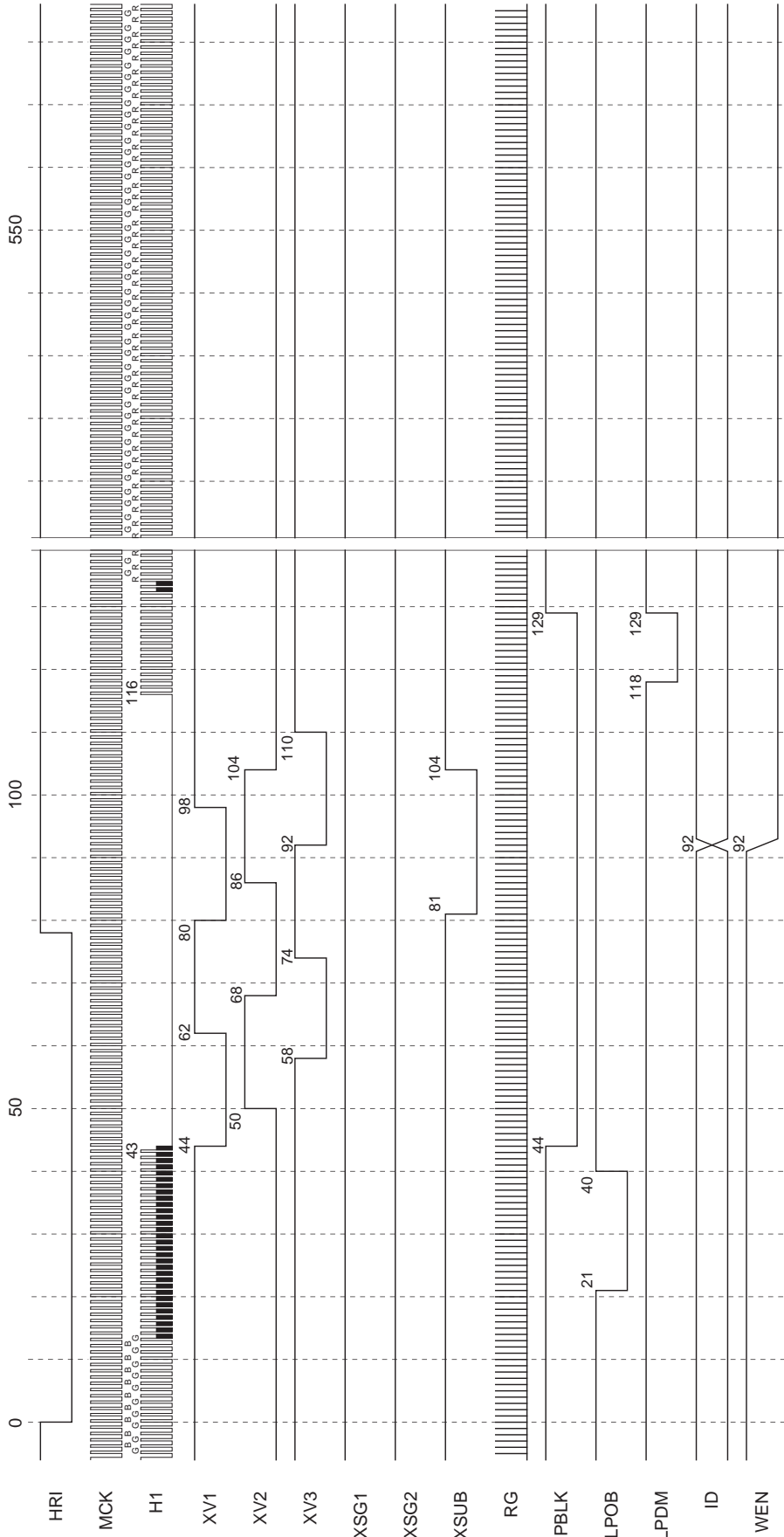

- \* The HRI of this chart is equivalent to HRI1 of Chart-7. This HRI indicates a timing that the CXD2452R takes in actually.
- \* The numbers at the output pulse transition points indicate the count at the MCK (780fH) rise from the fall of HRI.
- \* The HRI fall interval should be between 3.6 to 9.4μs. This chart shows an interval of 780k (6.3μs).
- \* XSUB is output at the timing shown above when specified by the serial interface data.
- \* The ID transition timing is synchronized with the fall of XV3.
- \* WEN is output during the horizontal interval shown in Chart-2. The transition timing is the same as that for ID.
- \* R, G and B of H1 indicate the output pixel color. In addition to the lines starting from R and G shown above, there are also lines starting from G and B.



**Chart-6 Horizontal Direction Timing Chart** **MODE** (Base oscillation frequency: 23.40fH) **Applicable CCD image sensor**  
 Monitoring drive mode (readout portion) ICX098AK

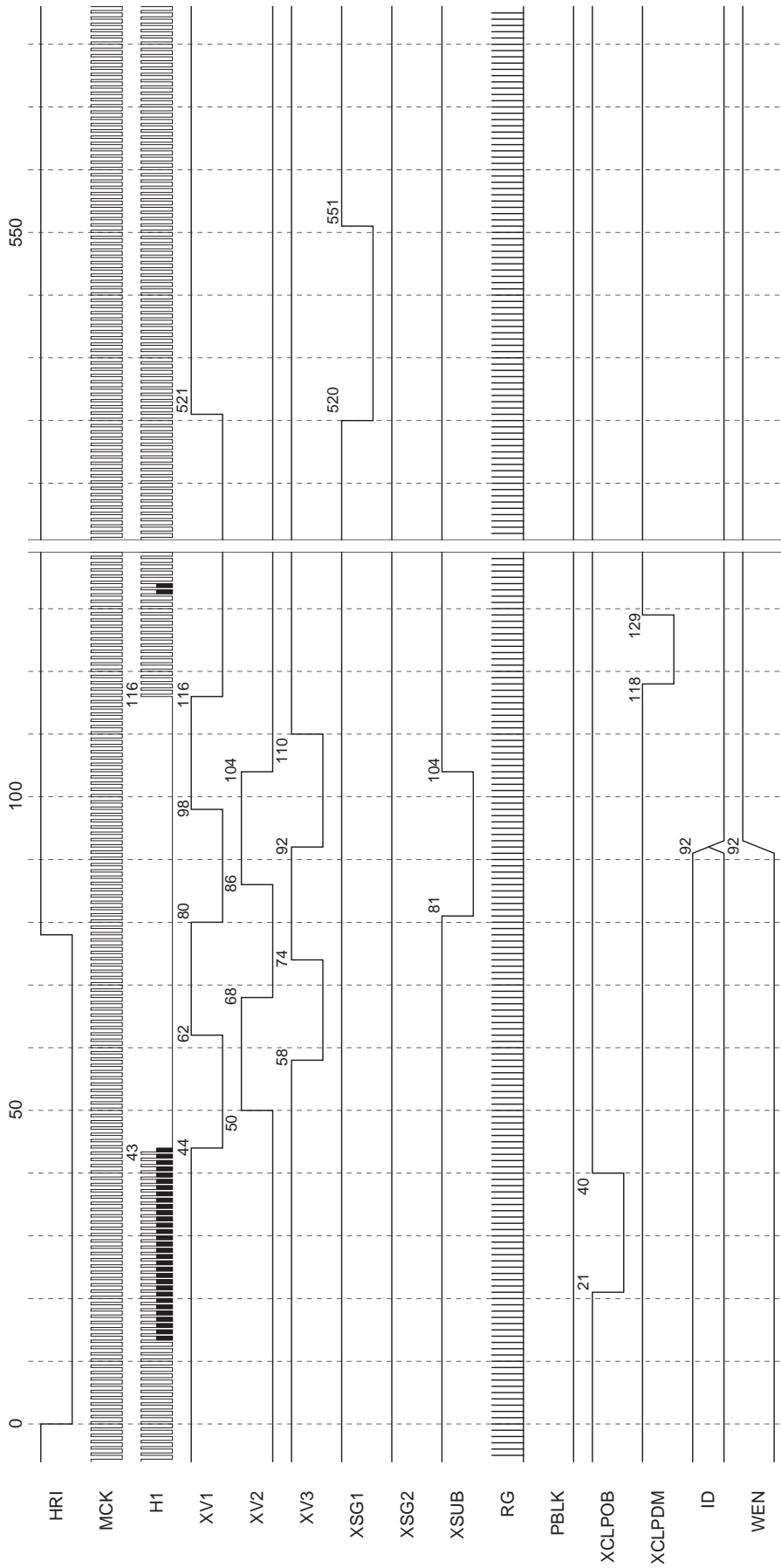

- \* The HRI of this chart is equivalent to HRI' of Chart-7. This HRI indicates a timing that the CXD2452R takes in actually.
- \* The numbers at the output pulse transition points indicate the count at the MCK (780fH) rise from the fall of HRI.
- \* The HRI fall interval should be between 3.6 to 9.4μs. This chart shows an interval of 78ck (6.3μs).
- \* XSUB is output at the timing shown above when specified by the serial interface data.
- \* The ID transition timing is synchronized with the fall of XV3. ID is reset low at this timing during the readout horizontal interval.
- \* WEN is output during the horizontal interval shown in Chart-2. The transition timing is the same as that for ID.

**Chart-7 High-speed Phase Timing Chart**

**MODE** (Base oscillation frequency: 2340fh)

**Applicable CCD image sensor**  
ICX098AK

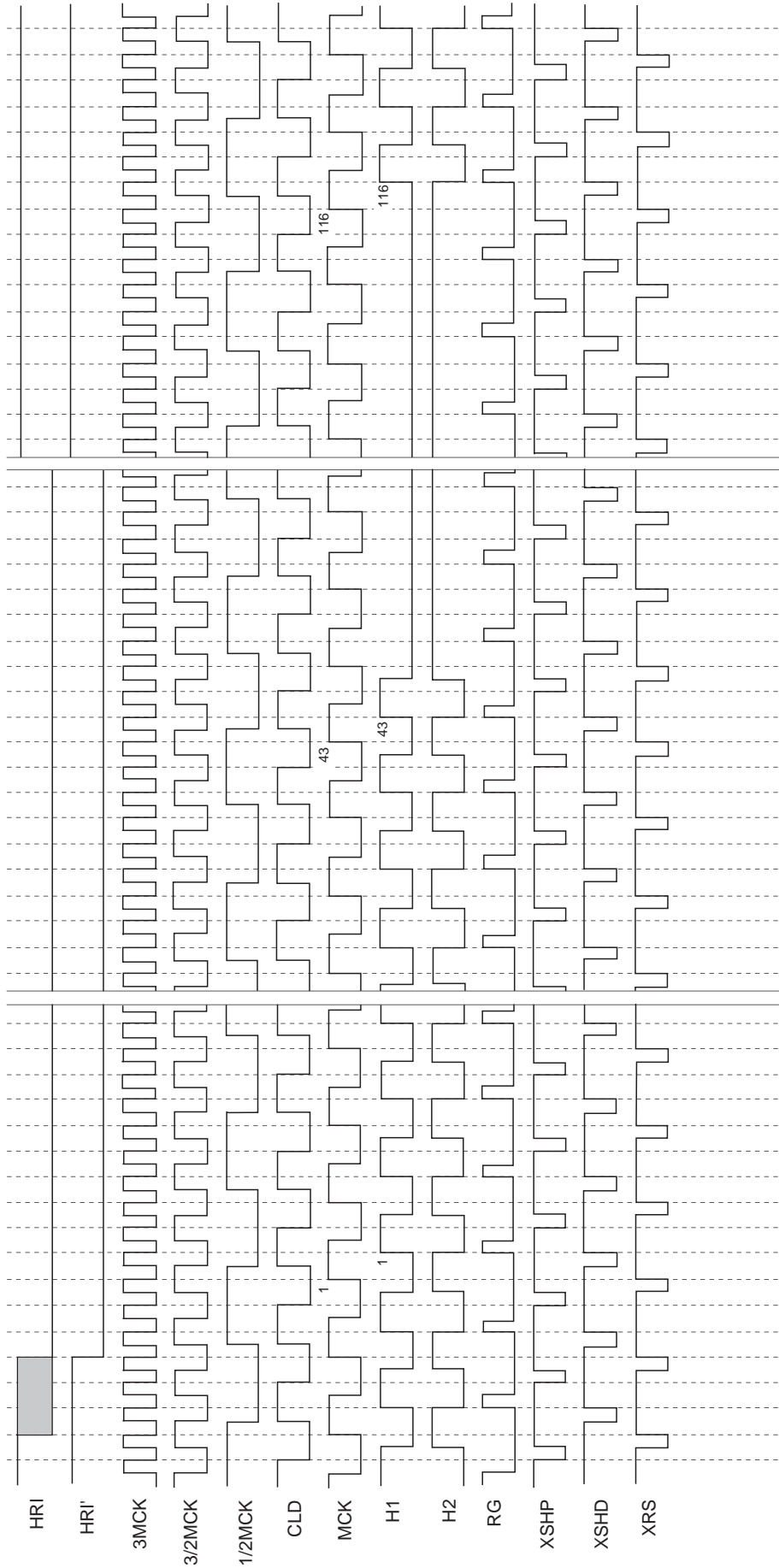

\* The phase relationship of each pulse indicates logical position. For actual output waveform, delay is added respectively.

\* HRI' indicates the HRI, which is a timing that taken in actually.

\* 3/2MCK and 1/2MCK can inverse polarity according to each serial interface data. This chart indicates that 3/2 MCK is negative polarity; 1/2 MCK is positive polarity.

Application Circuit Block Diagram

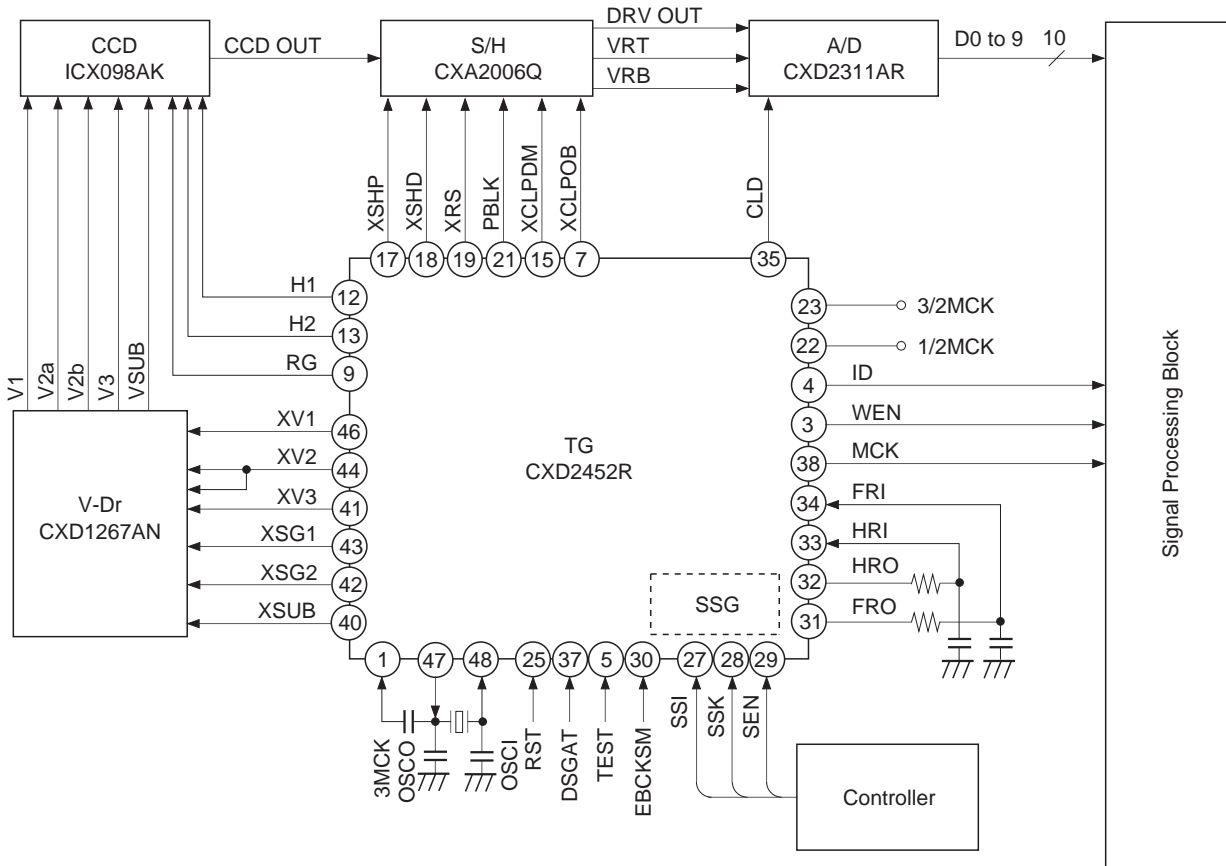

**Note)** When the CXD2311AR is used as A/D converter, CLD must be inversed.

Application circuits shown are typical examples illustrating the operation of the devices. Sony cannot assume responsibility for any problems arising out of the use of these circuits or for any infringement of third party patent and other right due to same.

Package Outline Unit: mm

48PIN LQFP (PLASTIC)

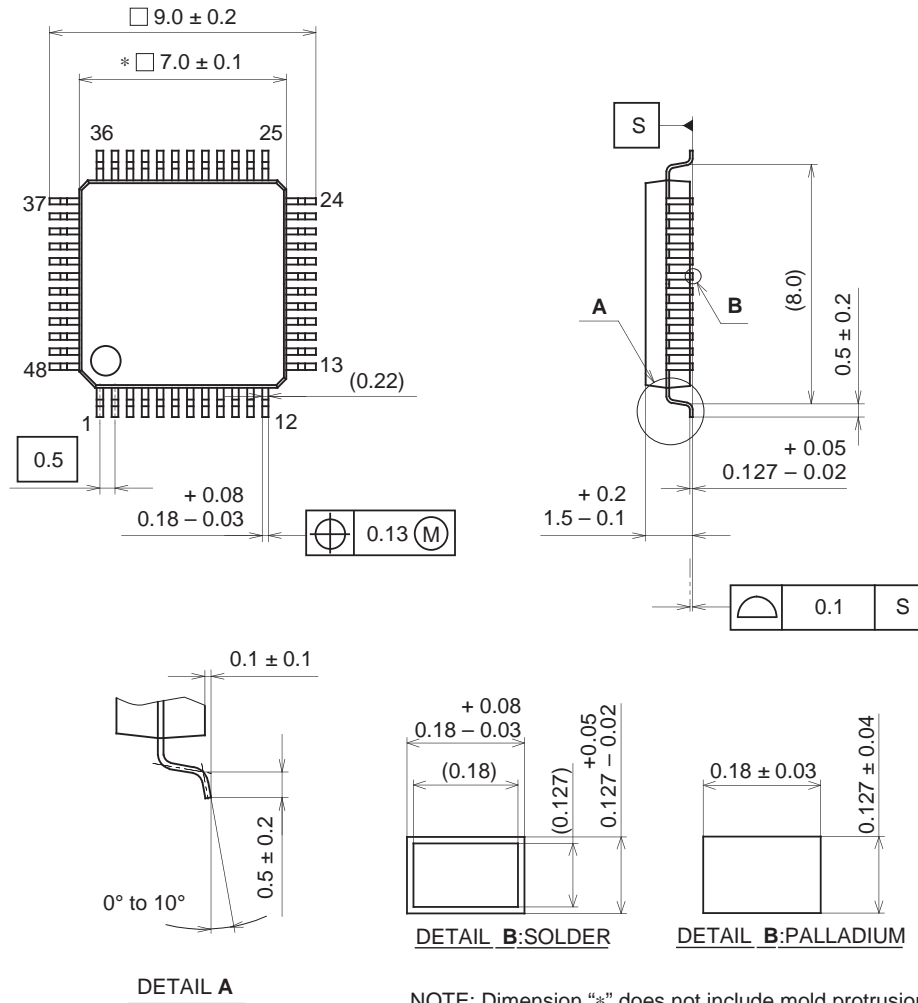

NOTE: Dimension "\*" does not include mold protrusion.

PACKAGE STRUCTURE

SONY CODE	LQFP-48P-L01
EIAJ CODE	LQFP048-P-0707
JEDEC CODE	_____

PACKAGE MATERIAL	EPOXY RESIN
LEAD TREATMENT	SOLDER/PALLADIUM PLATING
LEAD MATERIAL	42/COPPER ALLOY
PACKAGE MASS	0.2g