

Timing Generator for Progressive Scan CCD Image Sensor

Description

The CXD3609R is a timing generator IC which generates the timing pulses for performing progressive scan using the ICX274 CCD image sensor.

Features

- Base oscillation frequency 57.2/72MHz
- Electronic shutter function
- Supports draft/monitoring mode
- Trigger shutter function
- Vertical driver for CCD image sensor

Applications

- Digital still cameras
- Image processor

Structure

Silicon gate CMOS IC

Applicable CCD Image Sensors

ICX274 (Type 1/1.8, 2020K pixels)

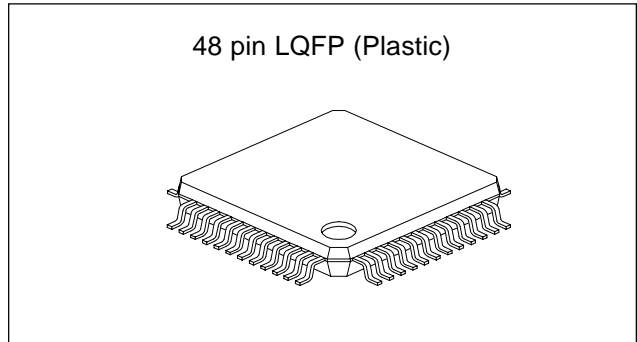

Absolute Maximum Ratings

• Supply voltage	V _{DD}	V _{SS} – 0.3 to +7.0	V
	V _L	–10.0 to V _{SS}	V
	V _H	V _L – 0.3 to +26.0	V
• Input voltage	V _I	V _{SS} – 0.3 to V _{DD} + 0.3	V
	• Output voltage	V _{O1}	V _{SS} – 0.3 to V _{DD} + 0.3
V _{O2}		V _L – 0.3 to V _{SS} + 0.3	V
V _{O3}		V _L – 0.3 to V _H + 0.3	V
• Operating temperature	T _{opr}	–20 to +75	°C
	• Storage temperature	T _{stg}	–55 to +150

Pin Configuration

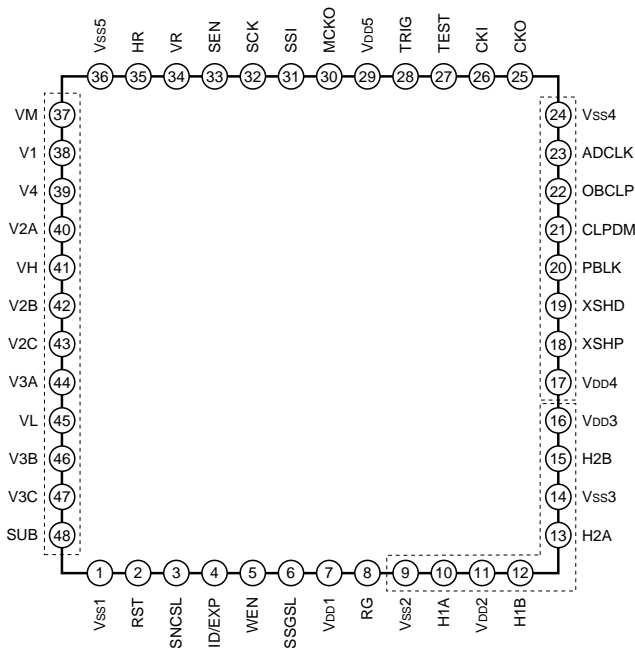

Recommended Operating Conditions

• Supply voltage	V _{DDA}	3.0 to 5.25	V
	V _{DDb} , V _{DDc}	3.0 to 3.6	V
	V _M	0.0	V
	V _H	14.5 to 15.5	V
• Operating temperature	V _L	–7.0 to –8.0	V
	T _{opr}	–20 to +75	°C

* Groups of pins enclosed in the figure indicate sections for which power supply separation is possible.

Sony reserves the right to change products and specifications without prior notice. This information does not convey any license by any implication or otherwise under any patents or other right. Application circuits shown, if any, are typical examples illustrating the operation of the devices. Sony cannot assume responsibility for any problems arising out of the use of these circuits.

Block Diagram

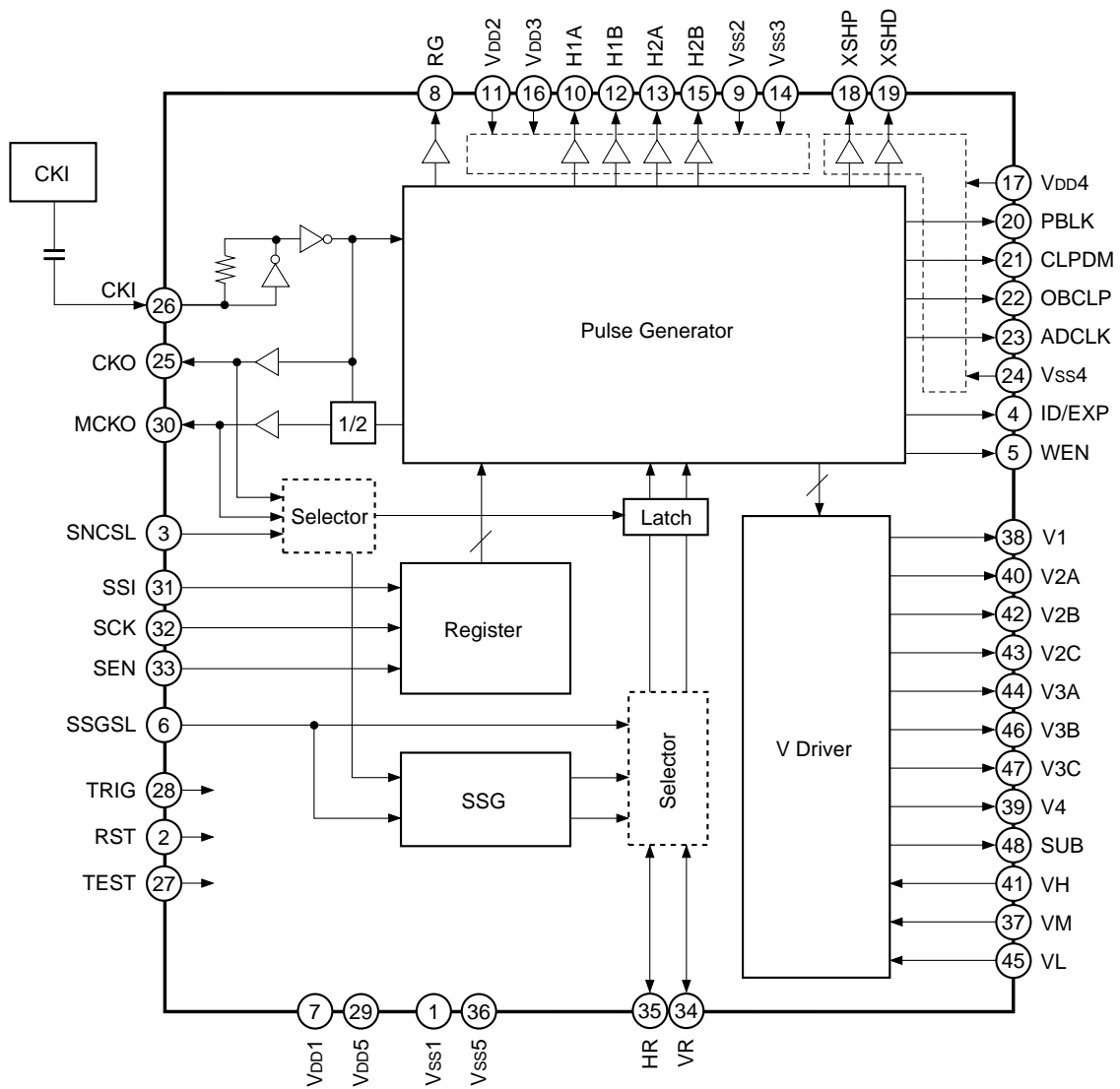

Pin Description

Pin No.	Symbol	I/O	Description
1	Vss1	—	GND
2	RST	I	Internal system reset input. High: Normal operation, Low: Reset control. Normally apply reset during power-on. Schmitt trigger input/protective diode on power supply side
3	SNCSL	I	Control input used to switch sync system. High: CKI sync, Low: MCKO sync. With pull-down resistor
4	ID/EXP	O	Vertical direction line identification pulse output/exposure time identification pulse output. Switching possible using the serial interface data. (Default: ID)
5	WEN	O	Memory write timing pulse output.
6	SSGSL	I	Internal SSG enable. High: Internal SSG valid, Low: External sync valid. With pull-down resistor
7	VDD1	—	3.3V power supply. (Power supply for common logic block)
8	RG	O	CCD reset gate pulse output. Logic phase adjustment possible using the serial interface data.
9	Vss2	—	GND
10	H1A	O	CCD horizontal register clock output. Logic phase adjustment possible using the serial interface data.
11	VDD2	—	5/3.3V power supply. (Power supply for H)
12	H1B	O	CCD horizontal register clock output. Logic phase adjustment possible using the serial interface data.
13	H2A	O	CCD horizontal register clock output. Logic phase adjustment possible using the serial interface data.
14	Vss3	—	GND
15	H2B	O	CCD horizontal register clock output. Logic phase adjustment possible using the serial interface data.
16	VDD3	—	5/3.3V power supply. (Power supply for H)
17	VDD4	—	3.3V power supply. (Power supply for CDS)
18	XSHP	O	CCD precharge level sample-and-hold pulse output. Logic phase adjustment possible using the serial interface data.
19	XSHD	O	CCD data level sample-and-hold pulse output. Logic phase adjustment possible using the serial interface data.
20	PBLK	O	Pulse output for horizontal and vertical blanking period pulse cleaning.
21	CLPDM	O	CCD dummy signal clamp pulse output.
22	OBCLP	O	CCD optical black signal clamp pulse output. The horizontal OB pattern can be changed using the serial interface data.
23	ADCLK	O	Clock output for analog/digital conversion IC. Logic phase adjustment possible using the serial interface data.
24	Vss4	—	GND
25	CKO	O	Inverter output.
26	CKI	I	Inverter input.

Pin No.	Symbol	I/O	Description
27	TEST	I	IC test pin. normally fixed to GND. With pull-down resistor
28	TRIG	I	Trigger mode. Normally fix to power supply.
29	V _{DD5}	—	3.3V power supply. (Power supply for common logic block)
30	MCKO	O	System clock output for signal processing IC.
31	SSI	I	Serial interface data input for internal mode settings. Schmitt trigger input/protective diode on power supply side.
32	SCK	I	Serial interface data input for internal mode settings. Schmitt trigger input/protective diode on power supply side.
33	SEN	I	Serial interface data input for internal mode settings. Schmitt trigger input/protective diode on power supply side.
34	VR	I/O	Vertical sync signal input/output.
35	HR	I/O	Horizontal sync signal input/output.
36	V _{SS5}	—	GND
37	VM	I	GND (GND for vertical driver)
38	V1	O	CCD vertical register clock output.
39	V4	O	CCD vertical register clock output.
40	V2A	O	CCD vertical register clock output.
41	VH	—	15.0V power supply. (Power supply for vertical driver)
42	V2B	O	CCD vertical register clock output.
43	V2C	O	CCD vertical register clock output.
44	V3A	O	CCD vertical register clock output.
45	VL	—	-7.5V power supply. (Power supply for vertical driver)
46	V3B	O	CCD vertical register clock output.
47	V3C	O	CCD vertical register clock output.
48	SUB	O	CCD electronic shutter pulse output.

Electrical Characteristics

DC Characteristics

(Within the recommended operating conditions)

Item	Pins	Symbol	Conditions	Min.	Typ.	Max.	Unit
Supply voltage 1	V _{DD2} , V _{DD3}	V _{DDa}		3.0	3.3	5.25	V
Supply voltage 2	V _{DD4}	V _{DDb}		3.0	3.3	3.6	V
Supply voltage 3	V _{DD1} , V _{DD5}	V _{DDc}		3.0	3.3	3.6	V
Input voltage 1*1	RST, SSI, SCK, SEN	V _{t+}		0.8V _{DDc}			V
		V _{t-}				0.2V _{DDc}	V
Input voltage 2*2	SNCSL, SSGSL, TEST	V _{IH1}		0.7V _{DDc}			V
		V _{IL1}				0.3V _{DDc}	V
Input voltage 3	TRIG	V _{IH1}		0.8V _{DDc}			V
		V _{IL1}				0.2V _{DDc}	V
Input/output voltage	VR, HR	V _{IH2}		0.8V _{DDc}			V
		V _{IL2}				0.2V _{DDc}	V
		V _{OH1}	Feed current where I _{OH} = -1.2mA	V _{DDc} - 0.8			V
		V _{OL1}	Pull-in current where I _{OL} = 2.4mA			0.4	V
Output voltage 1	H1A, H1B, H2A, H2B	V _{OH2}	Feed current where I _{OH} = -22.0mA	V _{DDa} - 0.8			V
		V _{OL2}	Pull-in current where I _{OL} = 14.4mA			0.4	V
Output voltage 2	XSHP, XSHD, PBLK, ADCLK, OBCLP, CLPDM	V _{OH3}	Feed current where I _{OH} = -3.3mA	V _{DDb} - 0.8			V
		V _{OL3}	Pull-in current where I _{OL} = 2.4mA			0.4	V
Output voltage 3	CKO	V _{OH4}	Feed current where I _{OH} = -6.9mA	V _{DDc} - 0.8			V
		V _{OL4}	Pull-in current where I _{OL} = 4.8mA			0.4	V
Output voltage 4	RG, MCKO	V _{OH5}	Feed current where I _{OH} = -3.3mA	V _{DDc} - 0.8			V
		V _{OL5}	Pull-in current where I _{OL} = 2.4mA			0.4	V
Output voltage 5	ID/EXP, WEN	V _{OH6}	Feed current where I _{OH} = -2.4mA	V _{DDc} - 0.8			V
		V _{OL6}	Pull-in current where I _{OL} = 4.8mA			0.4	V
Output current 1	V2A/B/C, V3A/B/C, V1, V4	I _{OL}	V1, V2A to C, V3A to C, V4 = -8.25V	10.0			mA
		I _{OM1}	V1, V2A to C, V3A to C, V4 = -0.25V			-5.0	mA
		I _{OM2}	V2A to C, V3A to C = 0.25V	5.0			mA
		I _{OH}	V2A to C, V3A to C = 14.75V			-7.2	mA
Output current 2	SUB	I _{OSL}	SUB = -8.25V	5.4			mA
		I _{OSH}	SUB = 14.75V			-4.0	mA

*1 These input pins are Schmitt trigger inputs, and have a protective diode on the power supply side in the IC. Therefore, they do not support 5V input.

*2 This input pin is with pull-down resistor in the IC.

Note) The above table indicates the condition for 3.3V drive.

Inverter Input Characteristics for Base Oscillation Clock Duty Adjustment

Item	Pins	Symbol	Conditions	Min.	Typ.	Max.	Unit
Logical V _{th}	CKI	LV _{th}			V _{DDC} /2		V
Input voltage		V _{IH}		0.7V _{DDC}			V
		V _{IL}				0.3V _{DDC}	V
Input amplitude		V _{IN}	f _{max} = 50MHz sine wave	0.3			V _{p-p}

Note) Input voltage is the input voltage characteristics for direct input from an external source.

Input amplitude is the input amplitude characteristics in the case of input through a capacitor.

Switching Characteristics

(V_H = 15.0V, V_M = GND, V_L = -7.5V)

Item	Symbol	Conditions	Min.	Typ.	Max.	Unit
Rise time	TTLM	V _L to V _M	200	350	500	ns
	TTMH	V _M to V _H	200	350	500	ns
	TTLH	V _L to V _H	30	60	90	ns
Fall time	TTML	V _M to V _L	200	350	500	ns
	TTHM	V _H to V _M	200	350	500	ns
	TTHL	V _H to V _L	30	60	90	ns
Output noise voltage	VCLH				1.0	V
	VCLL				1.0	V
	VCMH				1.0	V
	VCML				1.0	V

Notes)

- 1) The MOS structure of this IC has a low tolerance for static electricity, so full care should be given for measures to prevent electrostatic discharge.
- 2) For noise and latch-up countermeasures, be sure to connect a by-pass capacitor (0.1μF or more) between each power supply pin (V_H, V_L) and GND.
- 3) To protect the CCD image sensor, clamp the SUB pin output at V_H before input to the CCD image sensor.

Switching Waveforms

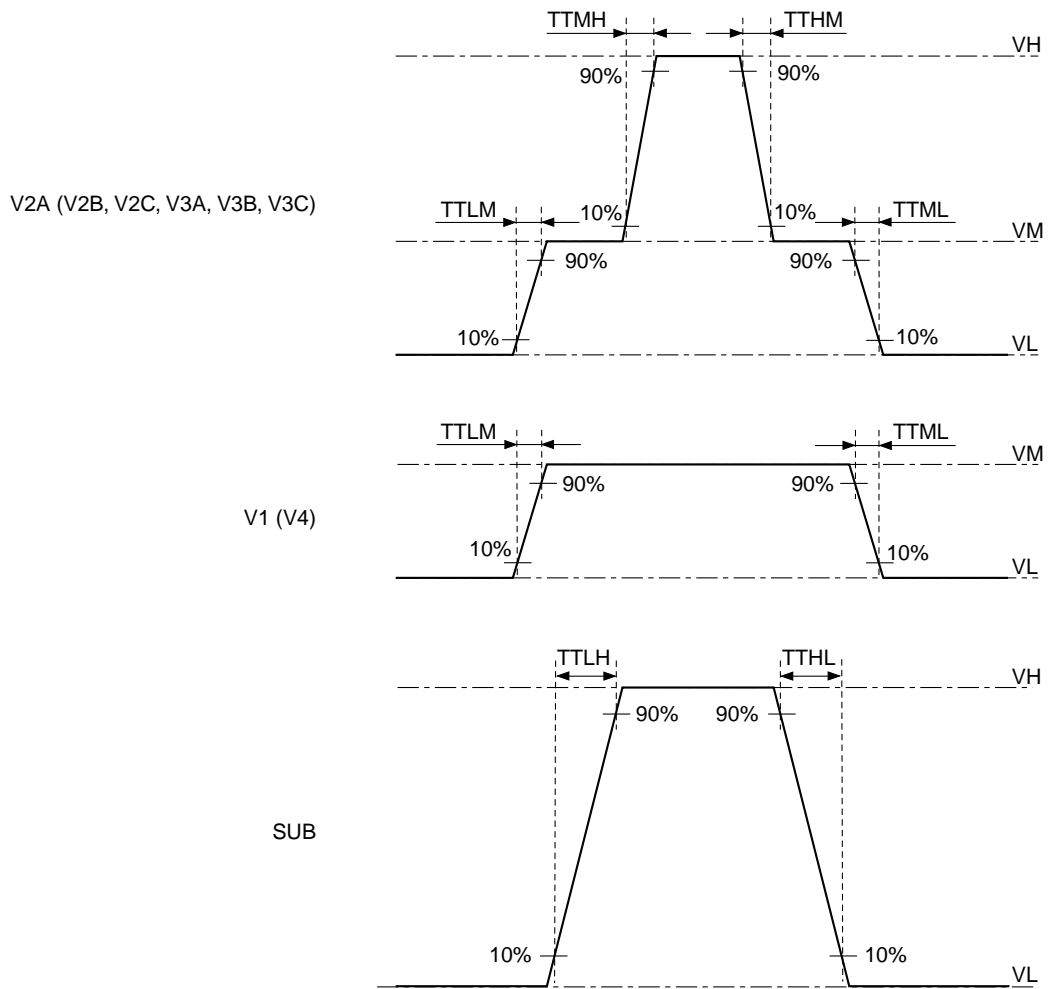

Waveform Noise

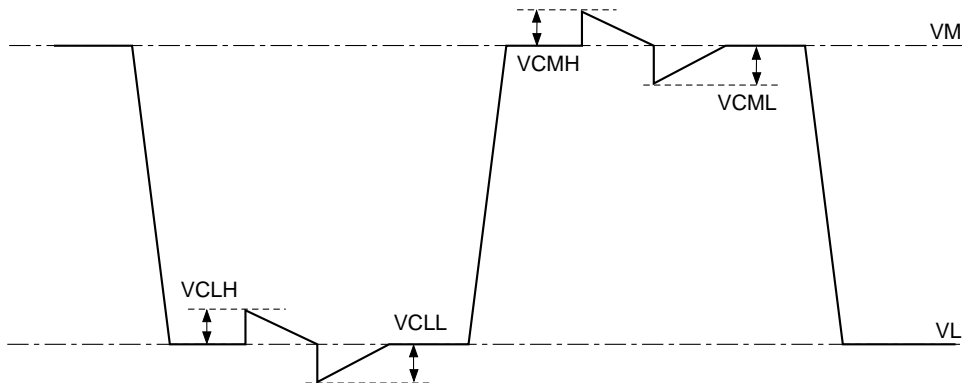

AC Characteristics

AC characteristics between the serial interface clocks

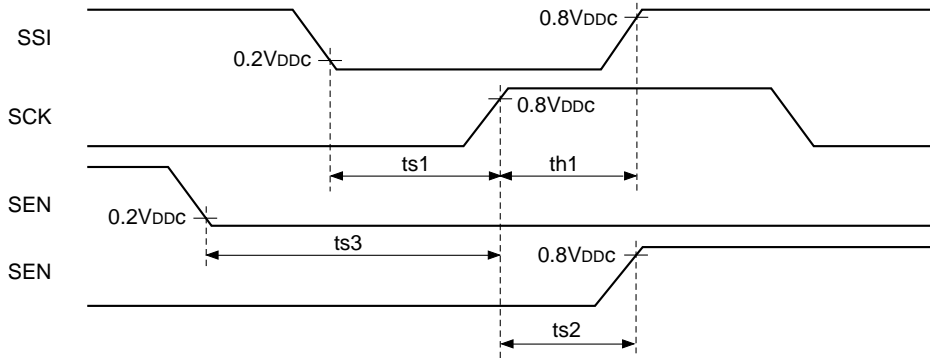

(Within the recommended operating conditions)

Symbol	Definition	Min.	Typ.	Max.	Unit
ts1	SSI setup time, activated by the rising edge of SCK	20			ns
th1	SSI hold time, activated by the rising edge of SCK	20			ns
ts2	SCK setup time, activated by the rising edge of SEN	20			ns
ts3	SEN setup time, activated by the rising edge of SCK	20			ns

Serial interface clock internal loading characteristics (1)

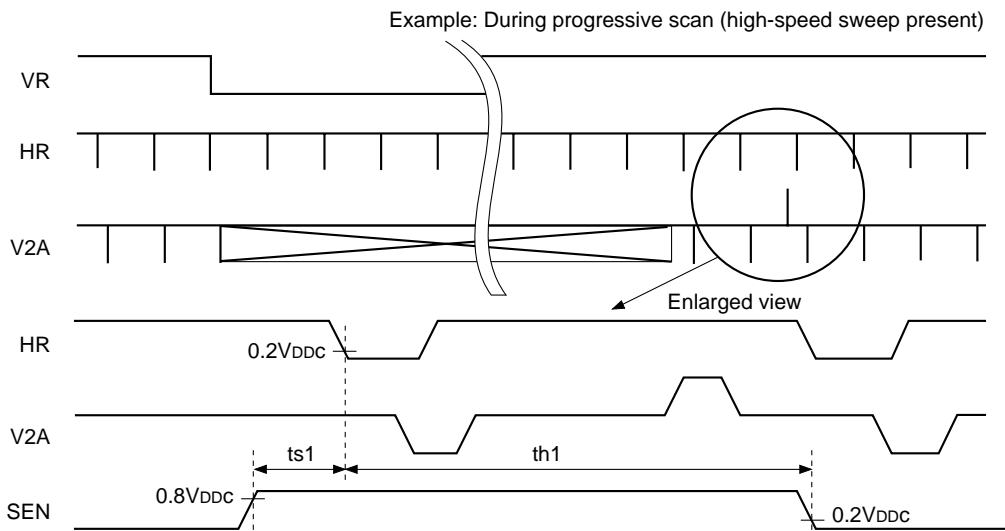

* Be sure to maintain a constantly high SEN logic level near the falling edge of the HR in the horizontal period during which V2A/B/C and V3A/B/C values take the ternary value and during that horizontal period.

(Within the recommended operating conditions)

Symbol	Definition	Min.	Typ.	Max.	Unit
ts1	SEN setup time, activated by the falling edge of HR	0			ns
th1	SEN hold time, activated by the falling edge of HR	53			μs

* Restriction for the operating frequency of 36MHz.

Serial interface clock internal loading characteristics (2)

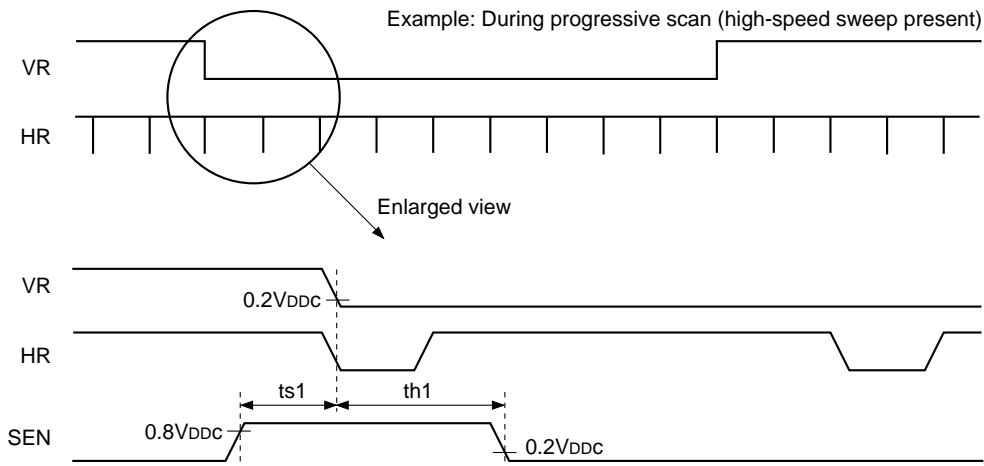

* Be sure to maintain a constantly high SEN logic level near the falling edge of VR.

(Within the recommended operating conditions)

Symbol	Definition	Min.	Typ.	Max.	Unit
ts1	SEN setup time, activated by the falling edge of VR	0			ns
th1	SEN hold time, activated by the falling edge of VR	200			ns

Serial interface clock output variation characteristics

Normally, the serial interface data is loaded to the CXD3609R at the timing shown in "Serial interface clock internal loading characteristics (1)" above. However, one exception to this is when the data such as STB is loaded to the CXD3609R and controlled at the rising edge of SEN. See "Description of Operation".

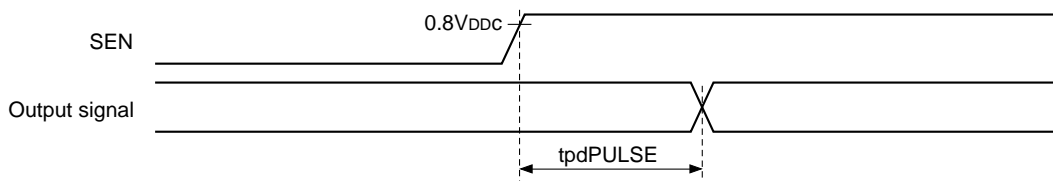

(Within the recommended operating conditions)

Symbol	Definition	Min.	Typ.	Max.	Unit
tpdPULSE	Output signal delay, activated by the rising edge of SEN	10		100	ns

RST loading characteristics

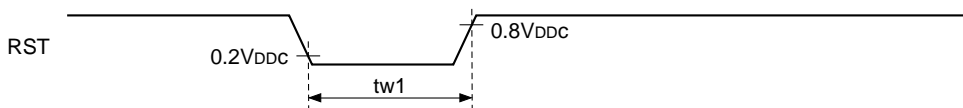

(Within the recommended operating conditions)

Symbol	Definition	Min.	Typ.	Max.	Unit
tw1	RST pulse width	35			ns

VR and HR phase characteristics

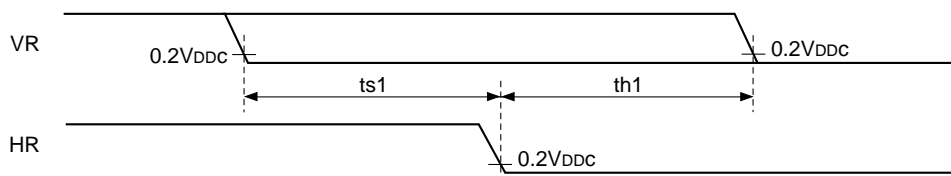

(Within the recommended operating conditions)

Symbol	Definition	Min.	Typ.	Max.	Unit
ts1	VR setup time, activated by the falling edge of HR	0			ns
th1	VR hold time, activated by the falling edge of HR	0			ns

HR loading characteristics

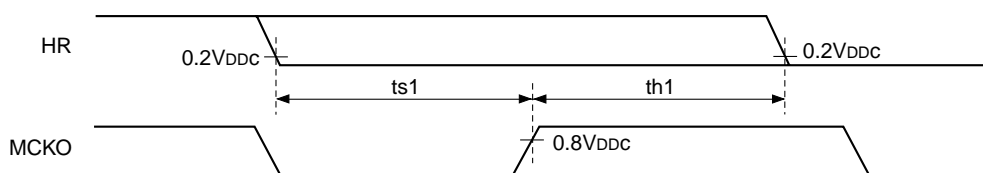

MCKO load capacitance = 10pF

(Within the recommended operating conditions)

Symbol	Definition	Min.	Typ.	Max.	Unit
ts1	HR setup time, activated by the rising edge of MCKO	13			ns
th1	HR hold time, activated by the rising edge of MCKO	0			ns

Output variation characteristics

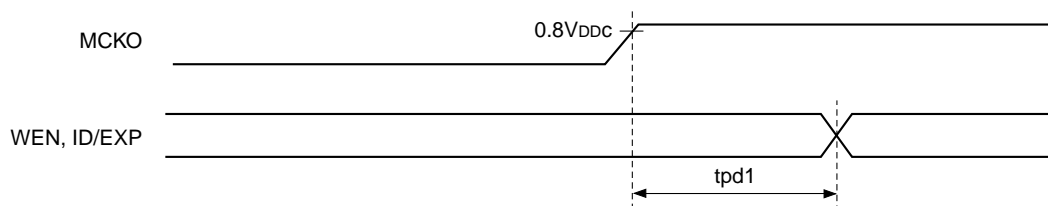

WEN and ID/EXP load capacitance = 10pF

(Within the recommended operating conditions)

Symbol	Definition	Min.	Typ.	Max.	Unit
tpd1	Time until the above outputs change after the rise of MCKO	20		60	ns

Description of Operation

Pulses output from the CXD3609R are controlled mainly by the **RST** pin and by the serial interface data. The Pin Status Table is shown below, and the details of serial interface control are described on the following pages.

Pin Status Table

Pin No.	Symbol	CAM	SLP	SST	STB	RST	Pin No.	Symbol	CAM	SLP	SST	STB	RST	
1	Vss1	—						25	CKO	ACT	ACT	L	L	ACT
2	RST	ACT	ACT	ACT	ACT	L	26	CKI	ACT	ACT	ACT	ACT	ACT	
3	SNCSL	ACT	ACT	ACT	ACT	ACT	27	TEST	—					
4	ID/EXP	ACT	L	L	L	L	28	TRIG	ACT	ACT	ACT	ACT	DIS	
5	WEN	ACT	L	L	L	L	29	Vdd5	—					
6	SSGSL	ACT	ACT	ACT	ACT	ACT	30	MCKO	ACT	ACT	L	L	ACT	
7	Vdd1	—						31	SSI	ACT	ACT	ACT	ACT	DIS
8	RG	ACT	L	L	L	ACT	32	SCK	ACT	ACT	ACT	ACT	DIS	
9	Vss2	—						33	SEN	ACT	ACT	ACT	ACT	DIS
10	H1A	ACT	L	L	L	ACT	34	VR	ACT	L	L	L	H	
11	Vdd2	—						35	HR	ACT	L	L	L	H
12	H1B	ACT	L	L	L	ACT	36	Vss5	—					
13	H2A	ACT	L	L	L	ACT	37	VM	—					
14	Vss3	—						38	V1	ACT	VM	VM	VM	VM
15	H2B	ACT	L	L	L	ACT	39	V4	ACT	VM	VM	VM	VL	
16	Vdd3	—						40	V2A	ACT	VH	VM	VH	VM
17	Vdd4	—						41	VH	—				
18	XSHP	ACT	L	L	L	ACT	42	V2B	ACT	VH	VM	VH	VM	
19	XSHD	ACT	L	L	L	ACT	43	V2C	ACT	VH	VM	VH	VM	
20	PBLK	ACT	L	L	L	H	44	V3A	ACT	VH	VM	VH	VL	
21	CLPDM	ACT	L	L	L	H	45	VL	—					
22	OBCLP	ACT	L	L	L	H	46	V3B	ACT	VH	VM	VH	VL	
23	ADCLK	ACT	L	L	L	ACT	47	V3C	ACT	VH	VM	VH	VL	
24	Vss4	—						48	SUB	ACT	VH	VH	VH	VL

*1 It is for output. For input, all items are "ACT".

Note) ACT means that the circuit is operating, and DIS means that loading is stopped. L indicates a low output level, and H a high output level in the controlled status.

Also, VH, VM and VL indicate the voltage levels applied to VH (Pin 41), VM (Pin 37) and VL (Pin 45), respectively, in the controlled status. Note that in sleep mode and standby mode, VH and VL power supply should be stopped together with the CCD image sensor.

Serial Interface Control

The CXD3609R basically loads and reflects the serial interface data sent in the following format. The position at which the data is reflected differs depending on the data, but normally the data is reflected at the rising edge of SEN, the falling edge of VR, or immediately before the readout block. See the load column for the reflection position of each data.

Note that as an exception, data loading is subject to restrictions during trigger shutter drive and long-time exposure. See these separate items for details.

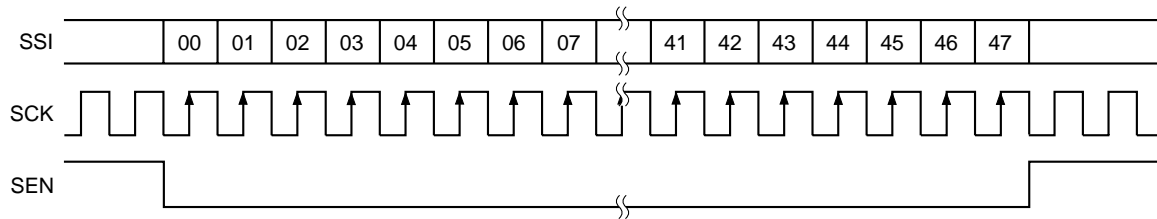

There are three categories of serial interface data: the CXD3609R drive control data (hereafter "control data"), electronic shutter data (hereafter "shutter data") and trigger shutter data (hereafter "TRIG data").

The details of each data are described below.

Control Data

Data	Symbol	Function	Data = 0	Data = 1	RST
D00 to D07	CHIP	Chip enable	10000001 → Enabled Other values → Disabled		All 0
D08, D09	CTG	Category switching	See Category.		All 0
D10, D11	—	—	—	—	All 0
D12 to D15	MODE	Drive mode switching	See Drive mode.		All 0
D16	OSCH	Base oscillation switching	28MHz	36MHz	0
D17	TRIGSL	TRIG control switching	OFF	ON	0
D18, D19	SMD	Electronic shutter mode switching	See Electronic shutter mode switching.		All 0
D20 to D22	—	—	—	—	All 0
D23	STPHS	H block stop control (2ch)	4ch	2ch	0
D24, D25	LDHS	H block logic phase adjustment	See Logic phase adjustment.		All 0
D26, D27	LDRG	RG logic phase adjustment	See Logic phase adjustment.		All 0
D28, D29	LDSP	XSHP logic phase adjustment	See Logic phase adjustment.		All 0
D30, D31	LDSD	XSHD logic phase adjustment	See Logic phase adjustment.		All 0
D32	—	—	—	—	0
D33	EXP	ID/EXP output switching	ID	EXP	0
D34, D35	PTOB	OBCLP waveform pattern switching	See OBCLP waveform pattern.		All 0
D36, D37	LDAD	ADCLK logic phase adjustment	See Logic phase adjustment.		1 0
D38, D39	STB	Standby control	See Standby.		All 0
D40 to D47	—	—	—	—	All 0

Shutter Data

Data	Symbol	Function	Data = 0	Data = 1	RST
D00 to D07	CHIP	Chip enable	10000001 → Enabled Other values → Disabled		All 0
D08, D09	CTG	Category switching	See Category.		All 0
D10 to D13	—	—	—	—	All 0
D14 to D23	SVR	Electronic shutter vertical period specification	See Electronic shutter.		All 0
D24 to D35	SHR	Electronic shutter horizontal period specification	See Electronic shutter.		All 0
D36, D37	—	—	—	—	All 0
D38 to D47	SPL	High-speed shutter position specification	See Electronic shutter.		All 0

TRIG Data

Data	Symbol	Function	Data = 0	Data = 1	RST
D00 to D07	CHIP	Chip enable	10000001 → Enabled Other values → Disabled		All 0
D08, D09	CTG	Category switching	See Category.		All 0
D10, D11	—	—	—	—	All 0
D12	TRHS	(Under trigger shutter drive) High-speed sweep switching	Present	Not present	All 0
D13 to D23	TRSH	(Under trigger shutter drive) Electronic shutter horizontal period specification	See Trigger shutter.		All 0
D24 to D35	TRSG	(Under trigger shutter drive) SG generation position specification	See Trigger shutter.		All 0
D36 to D40	—	—	—	—	All 0
D42 to D47	SINT	Electronic shutter fine adjustment specification	See Electronic shutter.		All 0

Detailed Description of Each Data

Shared data: **D08** and **D09** CTG [Category]

Of the data provided to the CXD3609R by the serial interface, the CXD3609R loads **D10** and subsequent data to each data register as shown in the table below according to the combination of **D08** and **D09**.

D09	D08	Description of operation
0	0	Loading to control data register
0	1	Loading to shutter data register
1	0	Loading to TRIG data register
1	1	Test mode

Note that the CXD3609R can apply these categories consecutively within the same vertical period. However, care should be taken as the data is overwritten if the same category is applied.

Control data: [D12] to [D15] MODE [Drive mode]

The CXD3609R realizes various drive modes using control data [D12] to [D15] MODE.

The drive mode-related bits are loaded to the CXD3609R and reflected at the falling edge of VR.

The details are described below.

The various basic drive modes are switched using the upper two bits [D12] and [D13] of the control data MODE.

D15	D14	Description of operation			
		(D13/12) = (0, 0)	(D13/12) = (0, 1)	(D13/12) = (1, 0)	(D13/12) = (1, 1)
0	0	Draft	Monitoring	Progressive scan (high-speed sweep not present)	Addition 1
0	1	Draft	Monitoring	Progressive scan (high-speed sweep not present)	Addition 1
1	0	Center scan 1	AF1	Center scan 3	Addition 1
1	1	Center scan 2	AF2	Progressive scan (high-speed sweep present)	Addition 1

Draft mode is the mode called 2/4-line readout mode in the ICX274.

Monitoring mode is the mode called 2/8-line readout mode in the ICX274. This is a drive mode with an even higher frame rate than draft mode that can be used for purposes such as monitoring and auto focus (AF).

Progressive scan mode is the ICX274 drive mode in which the data for all lines are read. Vertical transfer high-speed sweep period present/not present can be selected.

See the ICX274 data sheet for details of the readout lines for other modes.

The periods and Timing Charts when each mode is driven with the internal SSG are listed below.

Mode	Drive frequency	fps	Internal SSG period		V-Chart	H-Chart									
			Horizontal	Vertical		Normal	High-speed sweep	Frame shift	Readout						
Progressive scan	28	10	1920ck	1492H + 1860ck	Chart-1	Chart-11	—	—	Chart-23						
	36	15		1251H + 480ck											
Progressive scan – High-speed sweep –	28			1741H + 1530ck	Chart-4		Chart-4	Chart-16		Chart-20	Chart-29				
	36			1563H + 1021ck × 2											
Center scan 3	28	30		497H + 1260ck	Chart-7		Chart-13	Chart-15		Chart-19	Chart-27				
	36			625H + 1200ck	Chart-7.1										
Draft	28	20		692H + 810ck	Chart-2		Chart-13	Chart-15		Chart-19	Chart-25				
	36			870H + 900ck											
Addtion	28	30	692H + 810ck	Chart-10	Chart-15	Chart-19			Chart-26						
	36		870H + 900ck												
Center scan 1	28	30	461H + 1230ck	Chart-5	Chart-12	Chart-17			Chart-21			Chart-30			
	36		580H + 601ck	Chart-5.1											
Center scan 2	28	30	461H + 1230ck	Chart-6									Chart-18	Chart-22	Chart-28
	36		580H + 601ck	Chart-6.1											
Monitoring	28	60	405H + 1470ck × 2	Chart-3			Chart-12	Chart-17		Chart-21	Chart-24				
	36		510H + 1680ck												
AF1	28	60	202H + 1323ck × 2	Chart-8									Chart-17	Chart-21	Chart-30
	36		255H + 840ck	Chart-8.1											
AF2	28	120	101H + 1323ck	Chart-9	Chart-18	Chart-22			Chart-28						
	36		127H + 1596ck	Chart-9.1											

Control data: D16 OSCH [Drive frequency pattern switching]

This switches the internal SSG VR pattern. Change the base oscillation frequency applied to CKI to match each pattern.

D14	Description of operation
0	28MHz operation drive
1	36MHz operation drive

Control data: D17 TRIGSL [TRIG control switching]

This sets the TRIG pulse standby mode for performing TRIG drive. See TRIG control for a detailed description of TRIG drive.

Control data: D18 and D19 SMD [Electronic shutter mode switching]

This enables the various electronic shutter settings. See Shutter control for a detailed description of shutter drive.

D19	D18	Description of operation
0	0	Electronic shutter off
0	1	Electronic shutter on
1	0	Readout stopped setting, electronic shutter off
1	1	Readout stopped setting, a part of electronic shutter enabled

Control data: D23 STPHS [H block stop control]

This adjusts the driving capability by outputting the H driver output on 4ch or 2ch.

During 2ch output, the H1B and H2B pins are stopped. In addition, the load applied to the CXD3609R increases during 2ch output, so use of an external driver should also be considered depending on the situation.

D23	Description of operation
0	4ch output
1	2ch output

Control data: D24 and D25 LDHS [H block logic phase]

This indicates the H block logic phase adjustment data. The default is 0°.

D25	D24	Degree of adjustment (°)
0	0	0
0	1	90
1	0	180
1	1	270

Control data: D26 to D31 LDRG, LDSP, LDSD [Each pulse logic phase]

These indicate the RG, XSHP and XSHD logic phase adjustment data. The adjustment width is the same as for LDHS. The default is 0°.

Control data: D33 EXP [ID/EXP output switching]

The ID/EXP pin (Pin 4) output can be switched to the ID pulse or the EXP pulse using D33 EXP. The default is the "ID" pulse. See the Timing Charts for the ID pulse.

The EXP pulse indicates the exposure time when it is high. Normally, high is indicated from the falling edge of the last SUB to the falling edge of the next SG.



Note that the EXP pulse changes as follows when SUB does not rise.

Mode	Last SG generation position	EXP pulse rise point
Draft, 2-line addition 2, center scan 1	600, 750ck	804ck
2-line addition 1, center scan 2	1128, 1278ck	1296ck
Monitoring, progressive scan, center scan 3, AF1, AF2	1100, 1250ck	1322ck

Also, switching between ID and EXP is performed at the ID reset timing (the ID transition point during the horizontal period with each V1A/B/C and V3A/B/C ternary output), and the pulse is also reset to low at this point. See the explanatory diagrams under Electronic shutter for an image of ID/EXP pulse changes.

Control data: D34 and D35 PTOB [OBCLP waveform pattern]

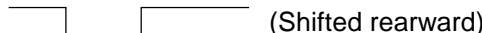
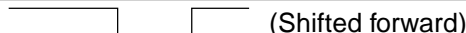
This indicates the OBCLP waveform pattern. The default is "Normal".

D35	D34	Waveform pattern
0	0	 (Normal)
0	1	 (Shifted rearward)
1	0	 (Shifted forward)
1	1	 (Wide)

Control data: D36 and D37 LDAD [ADCLK logic phase]

This indicates the ADCLK logic phase adjustment data. The default is "90°" relative to MCKO.

D37	D36	Degree of adjustment (°)
0	0	0
0	1	90
1	0	180
1	1	270

Control data: D38 and D39 STB [Standby]

The operating mode is switched as follows. However, the standby bits are loaded to the CXD3609R and control is applied immediately at the rising edge of SEN.

D39	D38	Symbol	Operating mode
X	0	CAM	Normal operating mode
0	1	SLP	Sleep mode
1	0	SST	Siesta mode
1	1	STB	Standby mode

See the Pin Status Table for the pin status in each mode.

Shutter data: [Electronic shutter]

The CXD3609R realizes various electronic shutter functions by using shutter data [D18] and [D19] SMD and shutter data [D14] to [D23] SVR, [D24] to [D35] SHR, [D38] to [D47] SPL and TRIG data [D42] to [D47] SINT. These functions are described in detail below.

First, the various modes are shown below. These modes are switched using control data [D13] and [D14] SMD.

D14	D13	Description of operation	SVR	SHR	SPL	SINT	Readout block stop	
0	0	Electronic shutter stopped mode	Invalid					
0	1	High-speed/low-speed shutter mode	Valid				Invalid	
1	0	Readout stopped mode, Electronic shutter stopped mode	Invalid				Valid	
1	1	Readout stopped mode, High-speed shutter mode	Invalid	Valid	Invalid	Valid	Valid	

[Electronic shutter stopped mode]

During this mode, all shutter data items are invalid.

SUB is not output in this mode, so the shutter speed is the accumulation time for one field.

[High-speed/low-speed shutter mode]

The electronic shutter data is expressed as shown in the table below using [D24] to [D35] SHR as an example. However, MSB (D35) is a reserve bit for the future specification, and it is handled as a dummy on this IC.

MSB												LSB
D35	D34	D33	D32	D31	D30	D29	D28	D27	D26	D25	D24	
X	0	0	1	1	1	0	0	0	0	1	1	
	↓				↓				↓			
	1				C				3			

→ SHR is expressed as [1C3h].

During this mode, the shutter data items have the following meanings.

Symbol	Data	Description
SVR	Shutter: [D14] to [D23]	Number of vertical periods specification (000h ≤ SVR ≤ 3FFh)
SHR	Shutter: [D24] to [D35]	Number of horizontal periods specification (000h ≤ SHR ≤ 3FFh)
SPL	Shutter: [D38] to [D47]	Vertical period specification for high-speed shutter operation (000h ≤ SPL ≤ 3FFh)
SINT	TRIG: [D42] to [D47]	SUB position specification (mentioned later for details)

Note) The bit data definition area is assured in terms of the CXD3609R functions, and does not assure the CCD characteristics.

Description of SVR, SHR and SPL Operations

The period during which SVR and SHR are specified together is the shutter speed. An image of the exposure time calculation formula is shown below. In actual operation, the precise exposure time is calculated from the operating frequency, VR and HR periods, decoding value during the horizontal period, and other factors. Here, SG means sensor gate, that is to say, ternary value of V2A/B/C and V3A/B/C.

$$(Exposure\ time) = SVR \times (1V\ period) + \{(number\ of\ HR\ per\ 1V) - (SHR + 1)\} \times (1H\ period) + (distance\ from\ SUB\downarrow\ to\ SG\downarrow\ during\ the\ readout\ period)$$

Concretely, when specifying high-speed shutter, SVR is set to "000h". (See the figure.) During low-speed shutter, or in other words when SVR is set to "001h" or higher, the serial interface data is not loaded until this period is finished.

The vertical period indicated here corresponds to one field in each drive mode. In addition, the number of horizontal periods applied to SHR can be considered as (number of SUB pulses – 1).

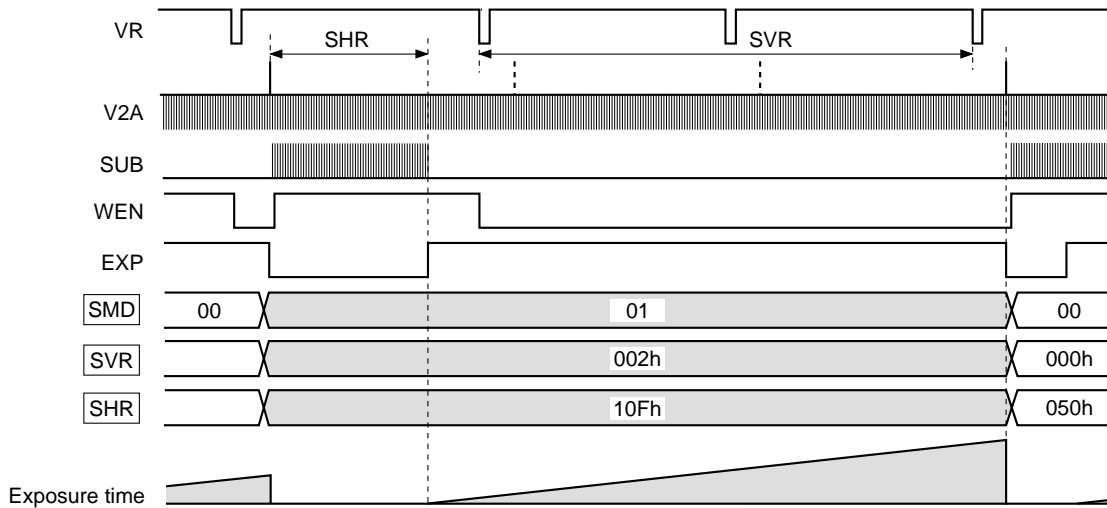

Further, SPL can be used during this mode to specify the SUB output at the optional vertical period during the low-speed shutter period.

In the case below, SUB is output based on SHR at the SPL vertical period out of (SVR + 1) vertical periods.

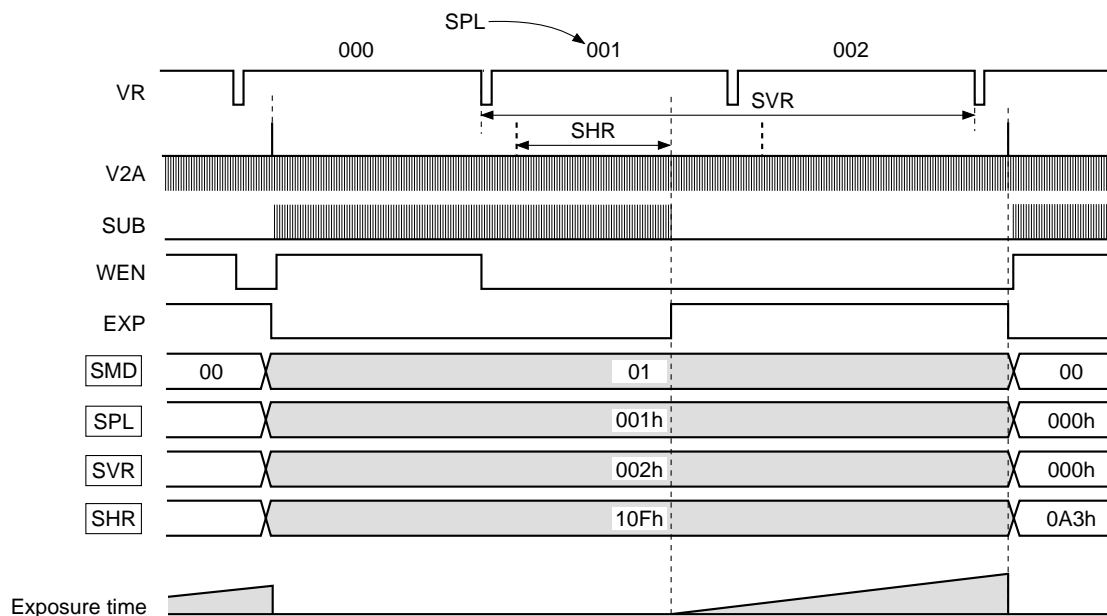

Incidentally, SPL is counted as "000h", "001h", "002h" and so on in conformance with SVR. At this time even if $SPL > SVR$ is set, operation conforms to the state when $SPL = SVR$.

Using this function it is possible to achieve smooth exposure time transitions when changing from low-speed shutter to high-speed shutter or vice versa.

Description of SINT Operation

The exposure time can be finely adjusted by specifying the TRIG data: [D42] to [D47] SINT in this setting. Concretely, this specifies the SUB output position during the horizontal period where the last SUB specified by SHR is output. The setting values are shown in the table below. When this function is disabled, the internal counter is also stopped.

This function makes it possible to smoothly shift the exposure time even during ultra-high-speed shutter operation.

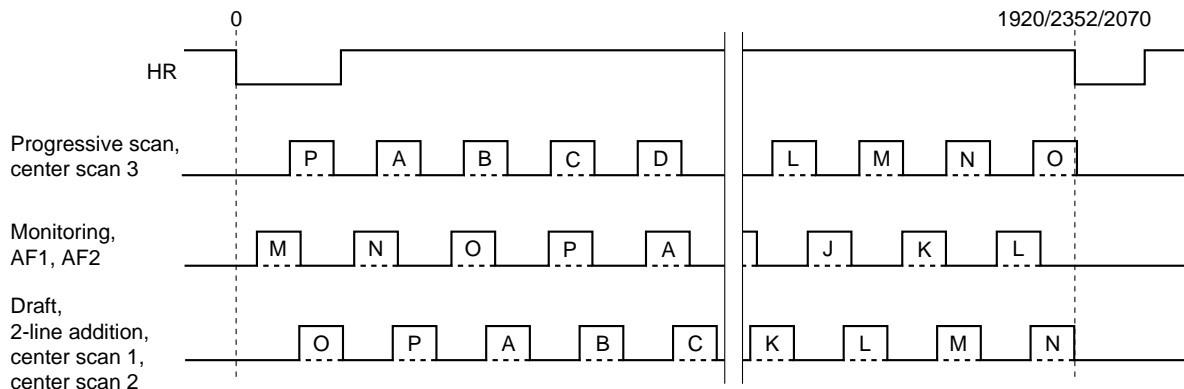

Position	Serial bits				Progressive scan, center scan 3		Monitoring, AF1, AF2		Draft, 2-line addition, center scan 1, center scan 2		
	D47/D46	D45	D44	D43	D42	↑ position	↓ position	↑ position	↓ position	↑ position	↓ position
A		0	0	0	0	187*	247*	619*	679*	334*	394*
B		0	0	0	1	307	367	766	826	463	523
C		0	0	1	0	427	487	913	973	592	652
D		0	0	1	1	547	607	1060	1120	721	781
E		0	1	0	0	667	727	1207	1267	850	910
F		0	1	0	1	787	847	1354	1414	979	1039
G		0	1	1	0	907	967	1501	1561	1108	1168
H		0	1	1	1	1027	1087	1648	1708	1237	1297
I		1	0	0	0	1147	1207	1795	1855	1366	1426
J		1	0	0	1	1267	1327	1942	2002	1495	1555
K		1	0	1	0	1387	1447	2089	2149	1624	1684
L		1	0	1	1	1507	1567	2236	2296	1753	1813
M		1	1	0	0	1627	1687	2383 (31)	2443 (91)	1882	1942
N		1	1	0	1	1747	1807	2530 (178)	2590 (238)	2011	2071 (1)
O		1	1	1	0	1867	1927 (7)	2677 (325)	2737 (385)	2140 (76)	2200 (130)
P		1	1	1	1	1987 (67)	2047 (127)	2824 (472)	2884 (532)	2269 (205)	2329 (259)

[Readout stopped setting, electronic shutter stopped]

This controls the V2A/B/C and V3A/B/C ternary outputs (readout pulse block). When this control is active, ternary output and modulation are stopped in the readout block. This realizes long-time exposure that is not limited by the internal counter.

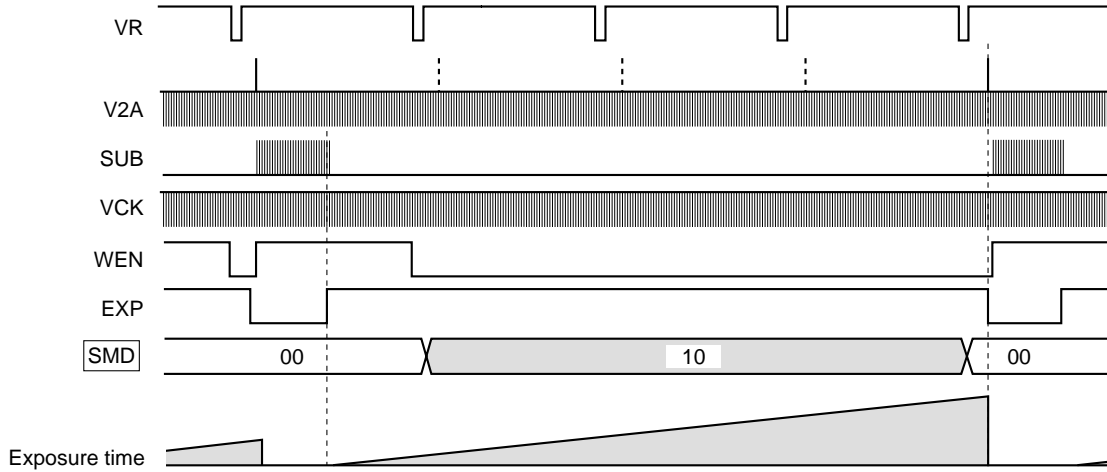

[Readout stopped setting, high-speed shutter enabled]

This controls the V2A/B/C and V3A/B/C ternary outputs (readout pulse block). When this control is active, ternary output and modulation are stopped in the readout portion. In addition, electronic shutter SHR and SINT are enabled. This realizes optional long-time exposure that is not limited by the internal counter.

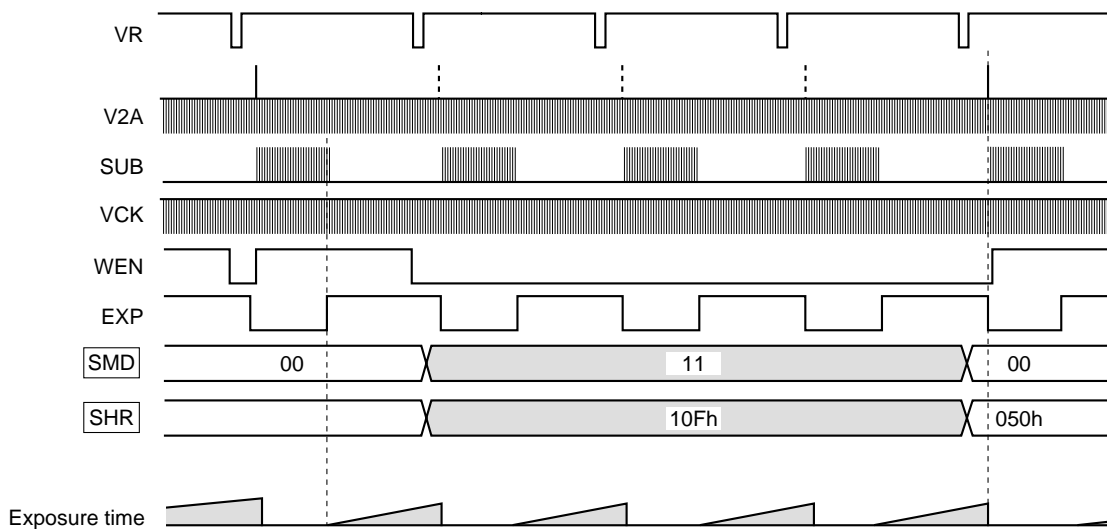

[TRIG control]

The CXD3609R has a trigger shutter function for loading images at an optional timing. This control is different from the conventional electronic shutter in that it is a shutter mode that it allows optional setting of the exposure start time.

When the trigger signal is applied to the TRIG pin with control data [D17] TRIGSL set to ON (trigger standby mode), the TRIG data is loaded and reflected at the next HR falling edge.

In addition, the exposure time (shutter speed) for this control is set by TRIG data [D13] to [D23] TRSH and [D24] to [D35] TRSG.

In standby mode, SUB rises every 1H, and the charge accumulated in the sensor is constantly discarded. In addition, the V clocks (V1 to V4) also constantly operate, so the undesired charge inside the vertical CCD is eliminated.

Therefore, the SG pulse stops until the external trigger is input, which means that the video cannot be monitored until the external trigger is input and signal readout is performed. After the external trigger is input, the preset number of shutter pulses and SG are generated. Note that when the serial data specifies number of SUB pulses > SG generation position, operation is the same as when number of SUB pulses = SG generation position.

When the SG position is not input 2H or more before the VR falling edge, VR is not accepted internally and trigger drive continues.

When exposure is completed under any conditions other than the above, the exposure charge is transferred and output using the falling edge of VR as the reference. In this case, V1 to V4, CLPDM, CLPOB, PBLK and other pulses outside the readout block are output in the same manner as progressive scan mode. When transfer finishes, the trigger standby mode repeats.

Note that during trigger standby mode and trigger drive, serial data other than the following are not accepted, regardless of VR. In addition, TRIG is not accepted during trigger drive.

Serial data accepted even during trigger standby and drive

[Control data] STB, [Control data] TRIGSL, [TRIG data] TRHS, TRSH and TRSG

Recovery to normal mode returns to the mode before entering the trigger standby mode.

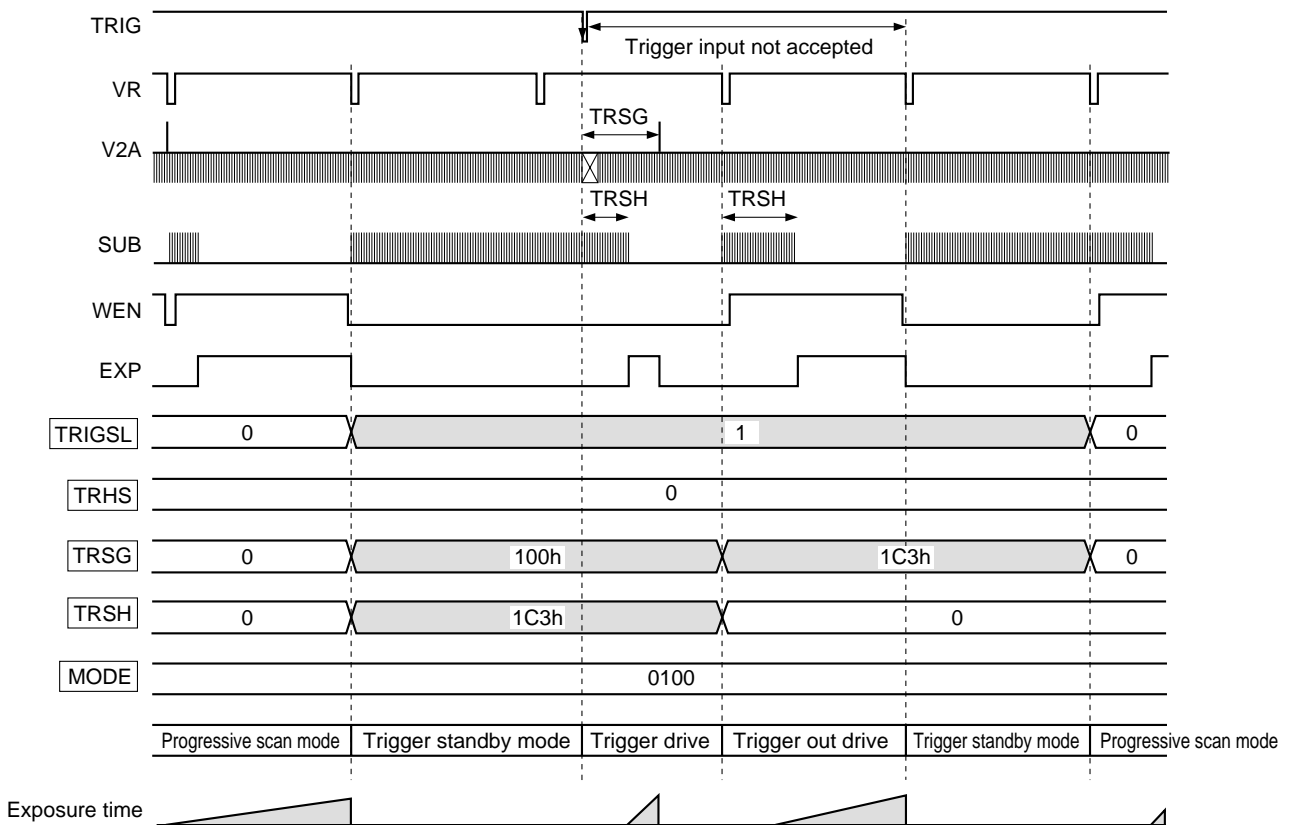
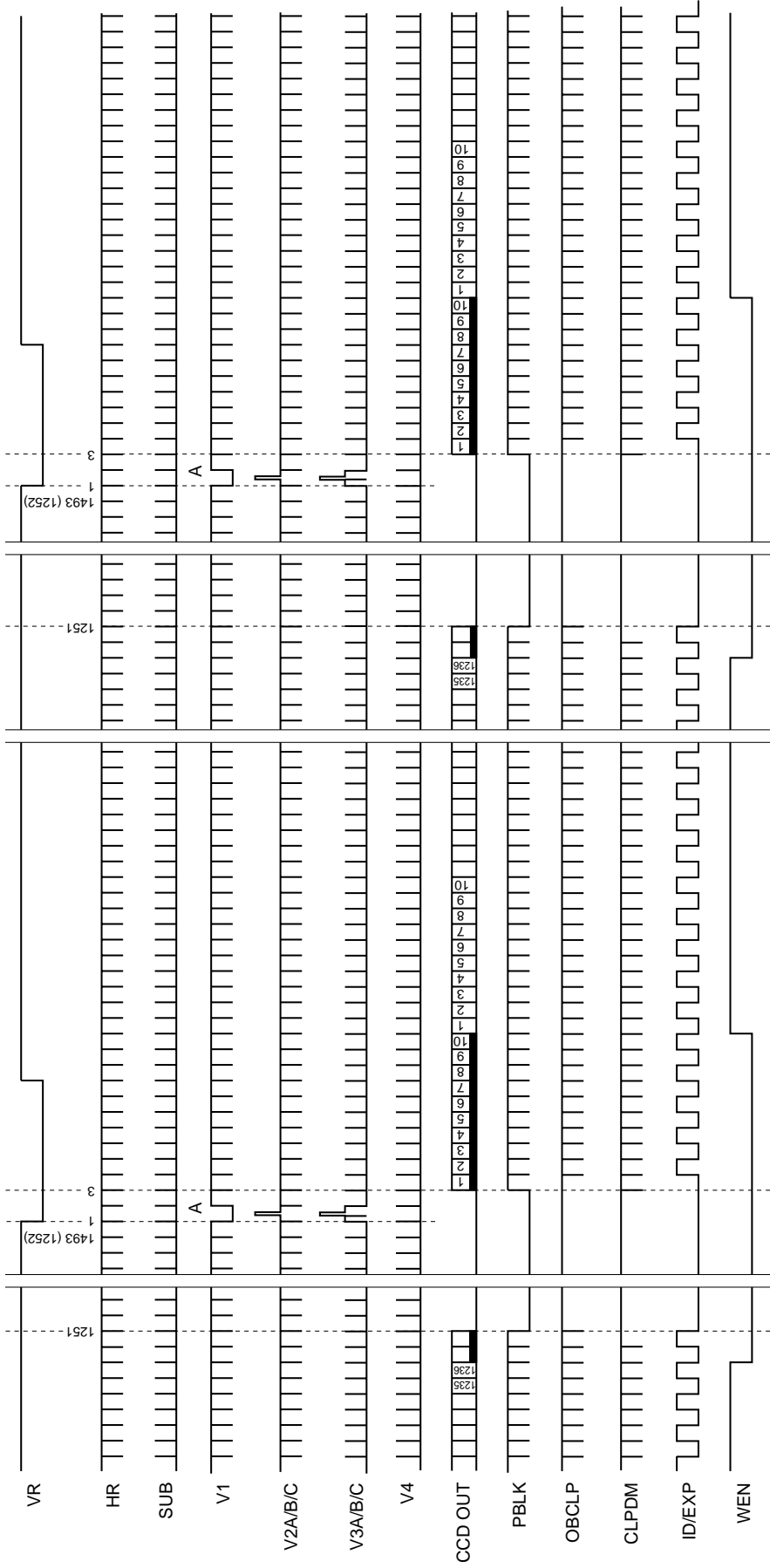
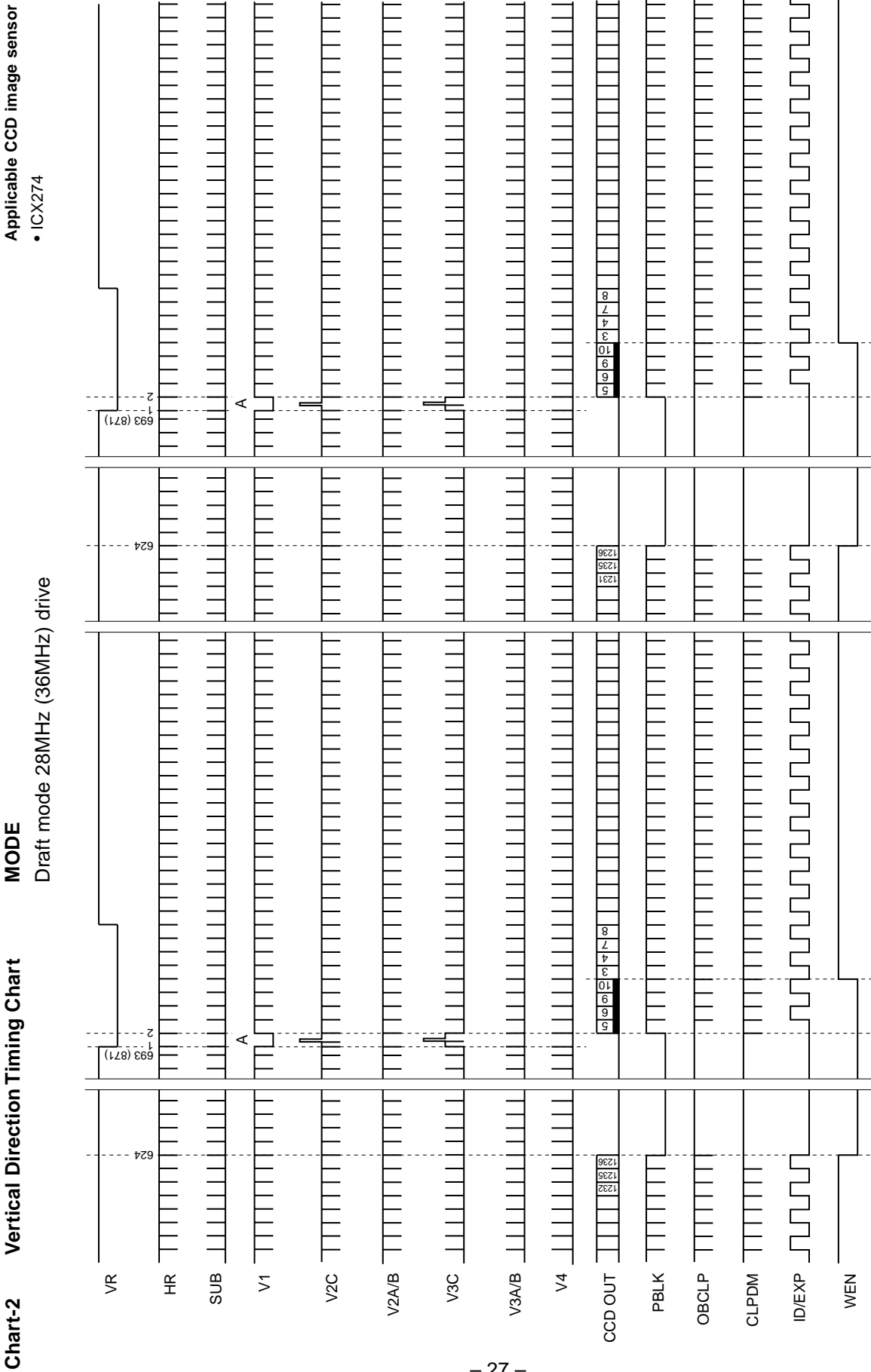

Chart-1 Vertical Direction Timing Chart **MODE** **Applicable CCD image sensor**
 Progressive scan mode – high-speed sweep not present – • ICX274
 28MHz (36MHz) drive



* The number of SUB pulses is determined by the serial interface data. This chart shows the case where SUB pulses are output in all horizontal periods.
 * ID/EXP of this chart shows ID. ID is low for lines where CCD OUT contains the R component, and high for lines where CCD OUT contains the B component.
 * During 28MHz drive, the VR period is 1493H, and at 1493H one horizontal period is 1860ck.
 During 36MHz drive, the VR period is 1252H, and at 1252H one horizontal period is 480ck.



* The number of SUB pulses is determined by the serial interface data. This chart shows the case where SUB pulses are output in all horizontal periods.
 * ID/EXP of this chart shows ID. ID is low for lines where CCD OUT contains the R component, and high for lines where CCD OUT contains the B component.
 * During 28MHz drive, the VR period is 693H, and at 693H one horizontal period is 810ck.
 During 36MHz drive, the VR period is 871H, and at 871H one horizontal period is 900ck.

Applicable CCD image sensor
• ICX274

Chart-3 Vertical Direction Timing Chart **MODE**
Monitoring mode 28MHz (36MHz) drive

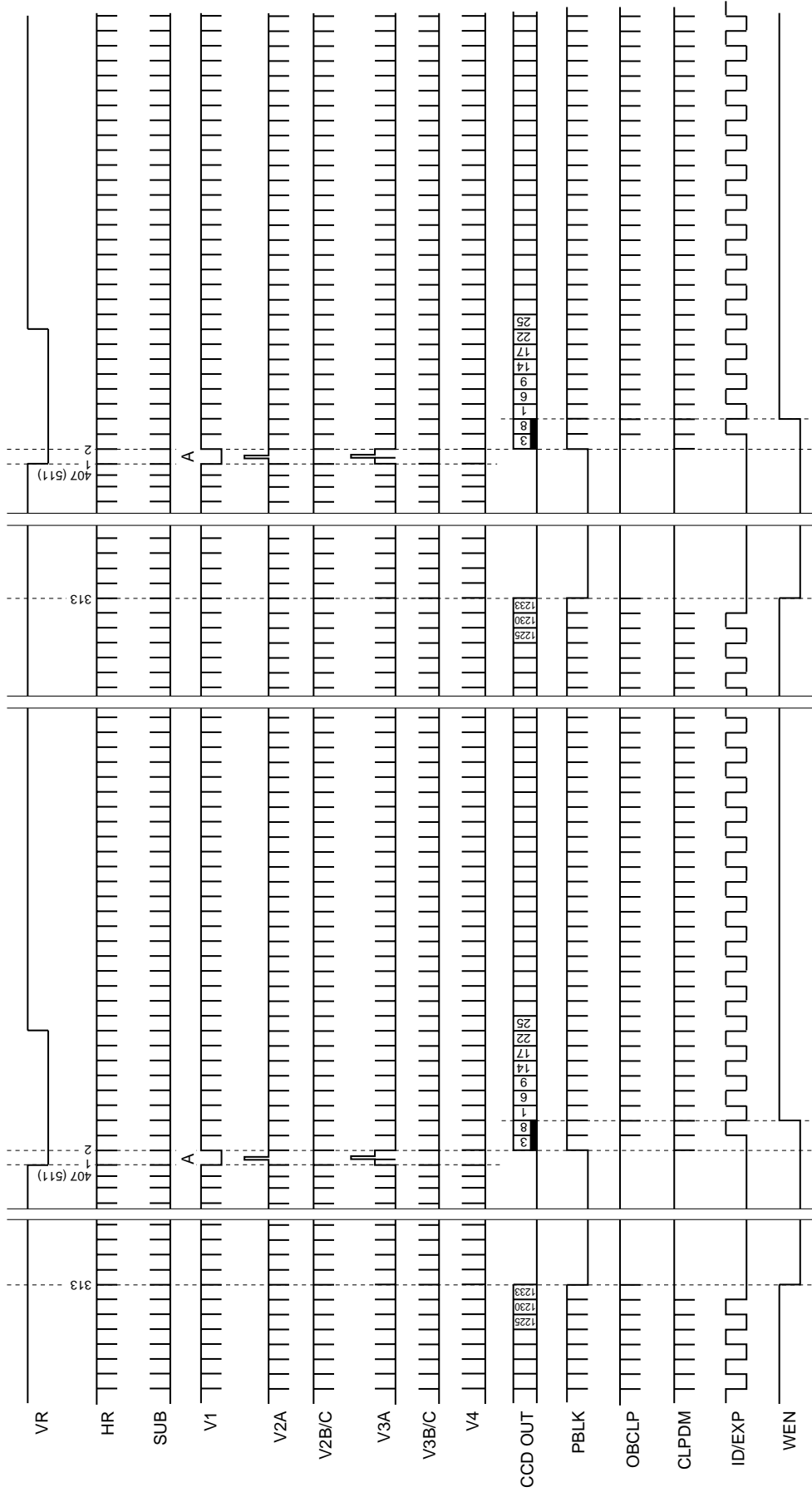

* The number of SUB pulses is determined by the serial interface data. This chart shows the case where SUB pulses are output in all horizontal periods.
 * ID/EXP of this chart shows ID. ID is low for lines where CCD OUT contains the R component, and high for lines where CCD OUT contains the B component.
 * During 28MHz drive, the VR period is 407H, and at 406H and 407H one horizontal period is 1470ck. During 36MHz drive, the VR period is 511H, and at 511H one horizontal period is 1680ck.

Chart-4 Vertical Direction Timing Chart

MODE

Progressive scan mode – high-speed sweep present –
28MHz (36MHz) drive

Applicable CCD image sensor
• ICX274

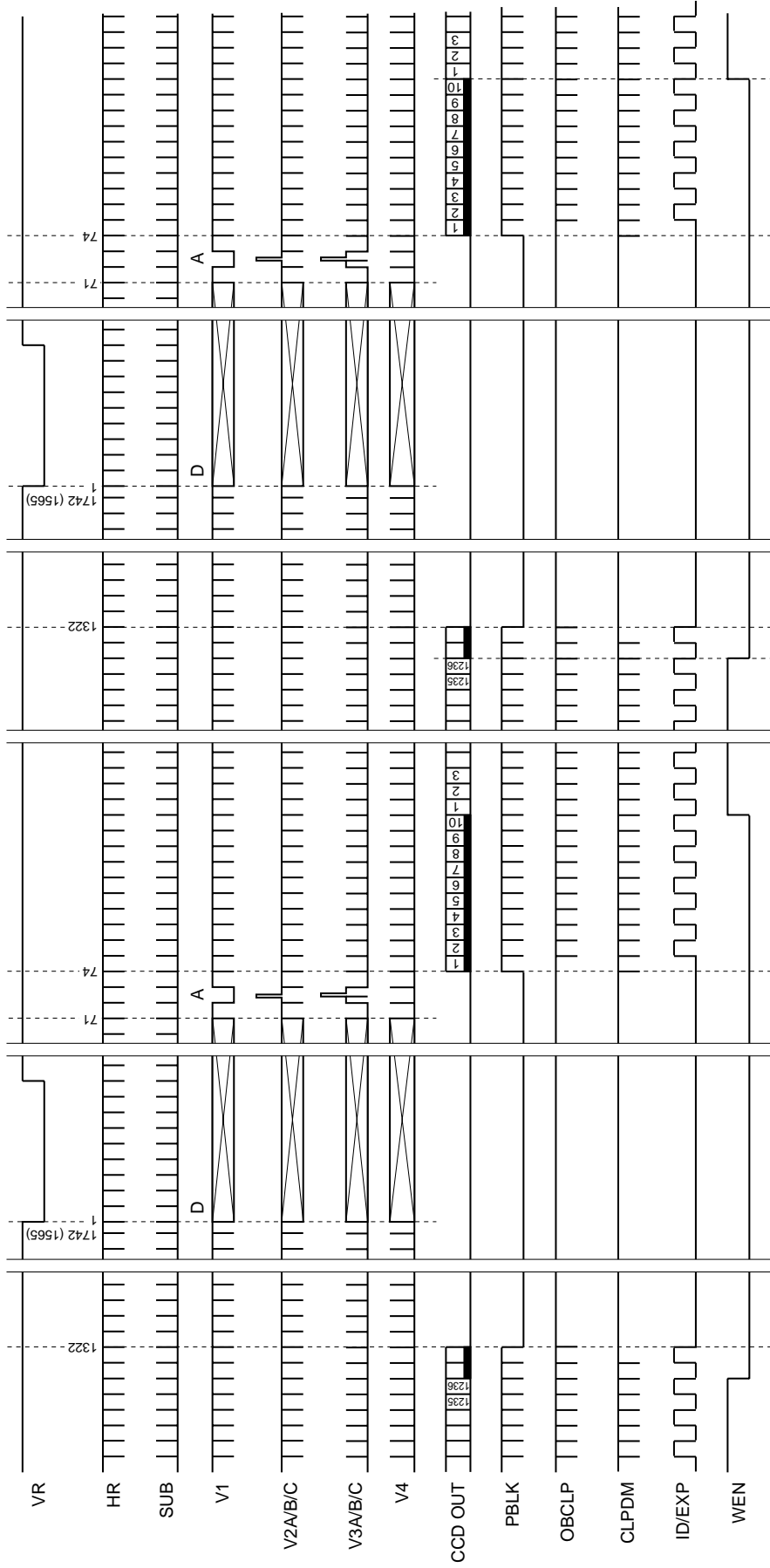

* The number of SUB pulses is determined by the serial interface data. This chart shows the case where SUB pulses are output in all horizontal periods.
 * ID/EXP of this chart shows ID. ID is low for lines where CCD OUT contains the R component, and high for lines where CCD OUT contains the B component.
 * During 28MHz drive, the VR period is 1742H, and at 1742H one horizontal period is 1530ck.
 During 36MHz drive, the VR period is 1565H, and at 1565H one horizontal period is 1021ck.

Chart-5 Vertical Direction Timing Chart

MODE

Center scan 1 mode 28MHz drive

Applicable CCD image sensor
• ICX274

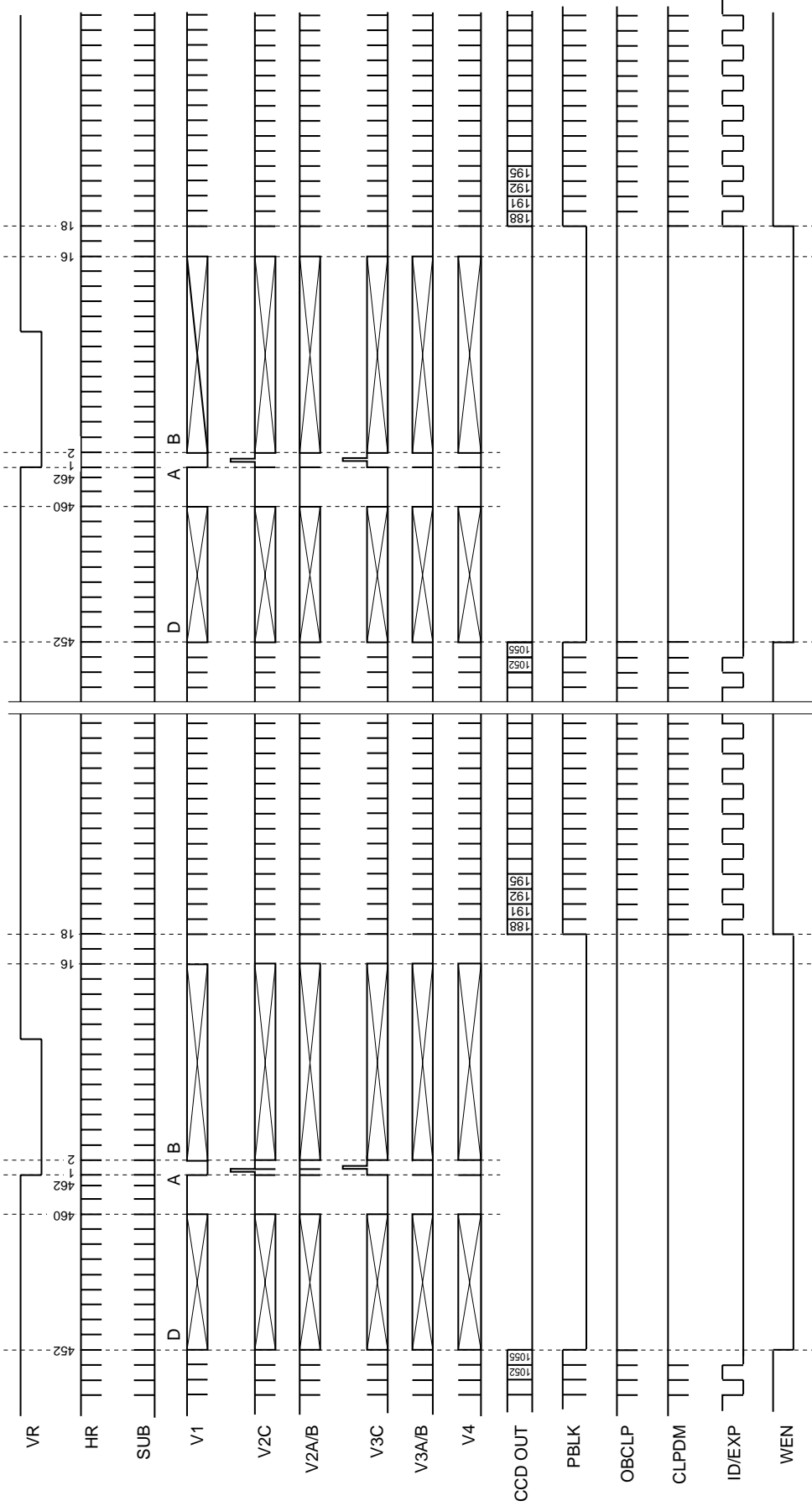

* The number of SUB pulses is determined by the serial interface data. This chart shows the case where SUB pulses are output in all horizontal periods.
 * ID/EXP of this chart shows ID. ID is low for lines where CCD OUT contains the R component, and high for lines where CCD OUT contains the B component.
 * At 462H one horizontal period is 1230ck.

Applicable CCD image sensor
 • ICX274

MODE
 Center scan 1 mode 36MHz drive

Chart-5.1 Vertical Direction Timing Chart

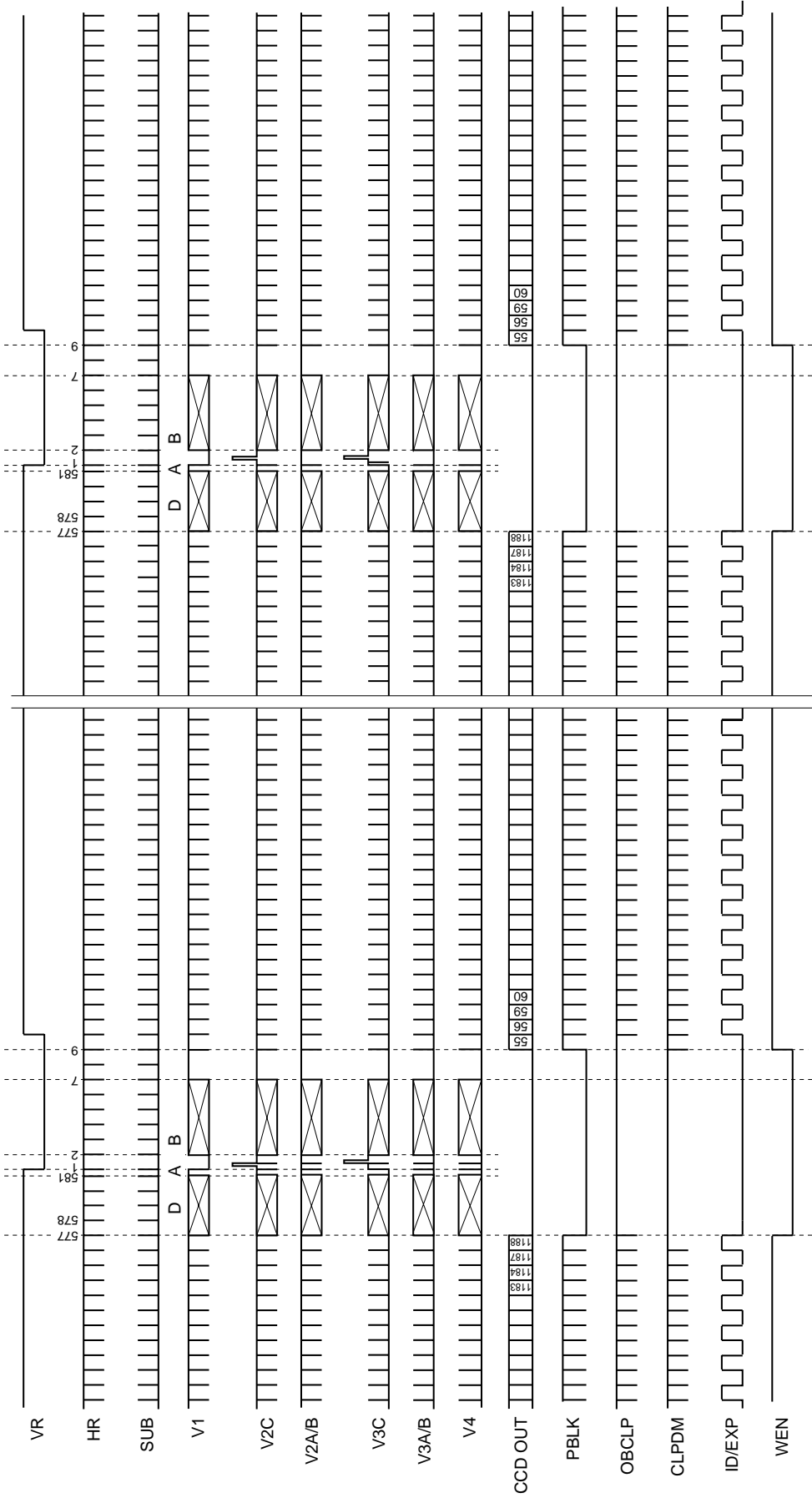

* The number of SUB pulses is determined by the serial interface data. This chart shows the case where SUB pulses are output in all horizontal periods.
 * ID/EXP of this chart shows ID. ID is low for lines where CCD OUT contains the R component, and high for lines where CCD OUT contains the B component.
 * At 581H one horizontal period is 601ck.

Applicable CCD image sensor
• ICX274

Chart-6 Vertical Direction Timing Chart MODE
Center scan 2 mode 28MHz drive

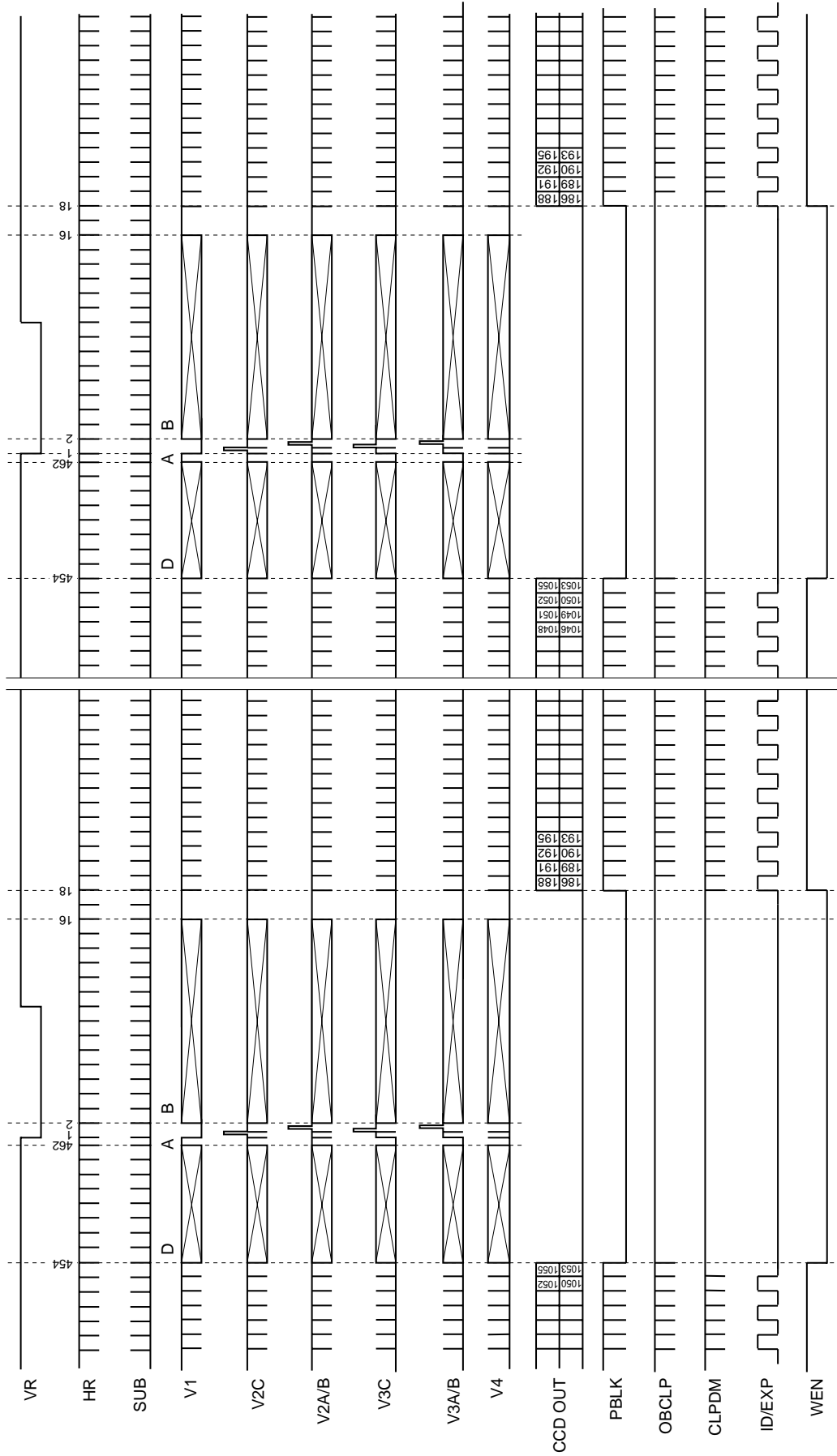

* The number of SUB pulses is determined by the serial interface data. This chart shows the case where SUB pulses are output in all horizontal periods.
* ID/EXP of this chart shows ID. ID is low for lines where CCD OUT contains the R component, and high for lines where CCD OUT contains the B component.
* At 462H one horizontal period is 1230ck.

Applicable CCD image sensor
• ICX274

MODE
Center scan 2 mode 36MHz drive

Chart-6.1 Vertical Direction Timing Chart

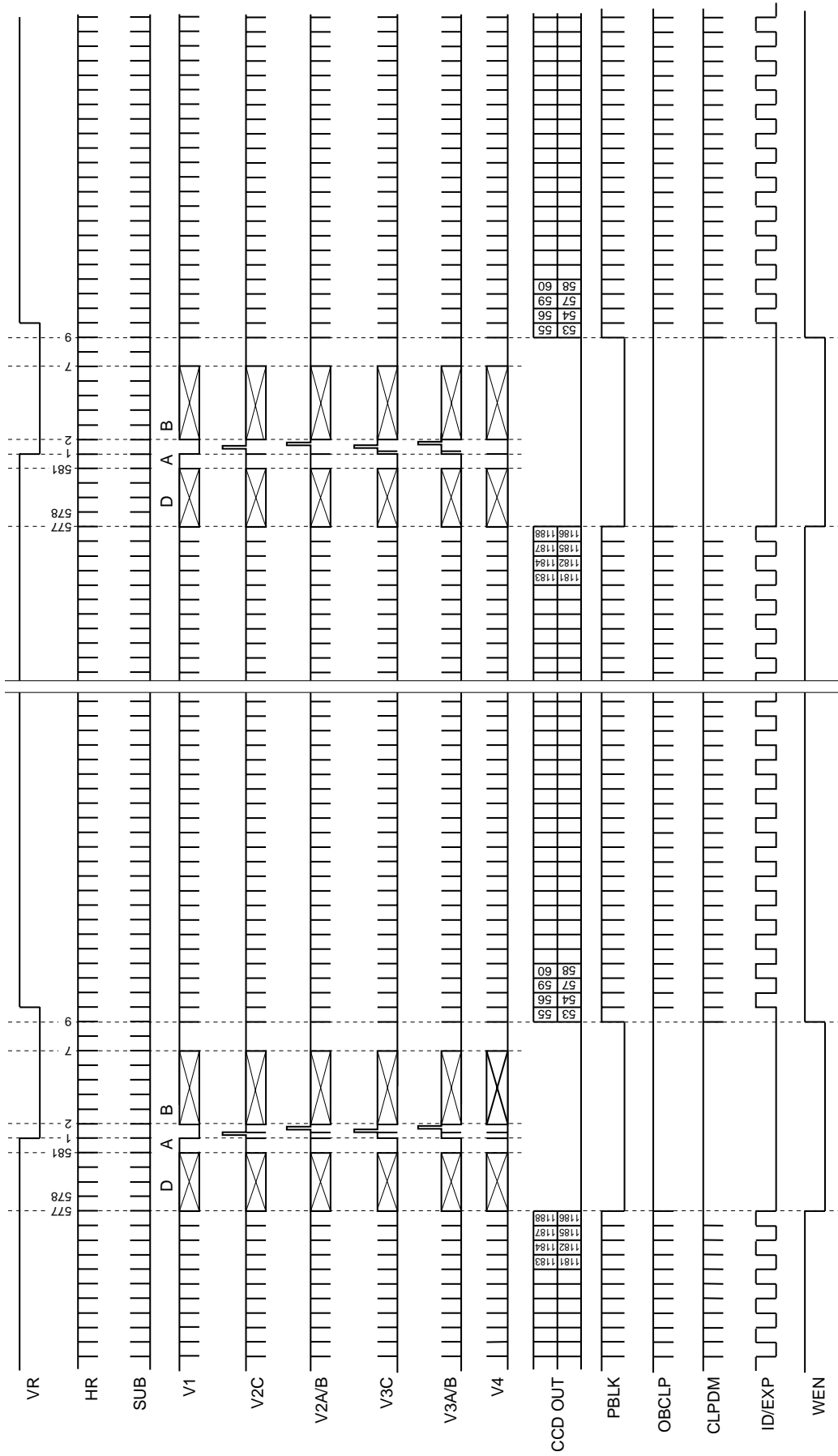

* The number of SUB pulses is determined by the serial interface data. This chart shows the case where SUB pulses are output in all horizontal periods.
 * ID/EXP of this chart shows ID. ID is low for lines where CCD OUT contains the R component, and high for lines where CCD OUT contains the B component.
 * At 581H one horizontal period is 601ck.

Chart-7 Vertical Direction Timing Chart

MODE

Center scan 3 mode 28MHz drive

Applicable CCD image sensor
• ICX274

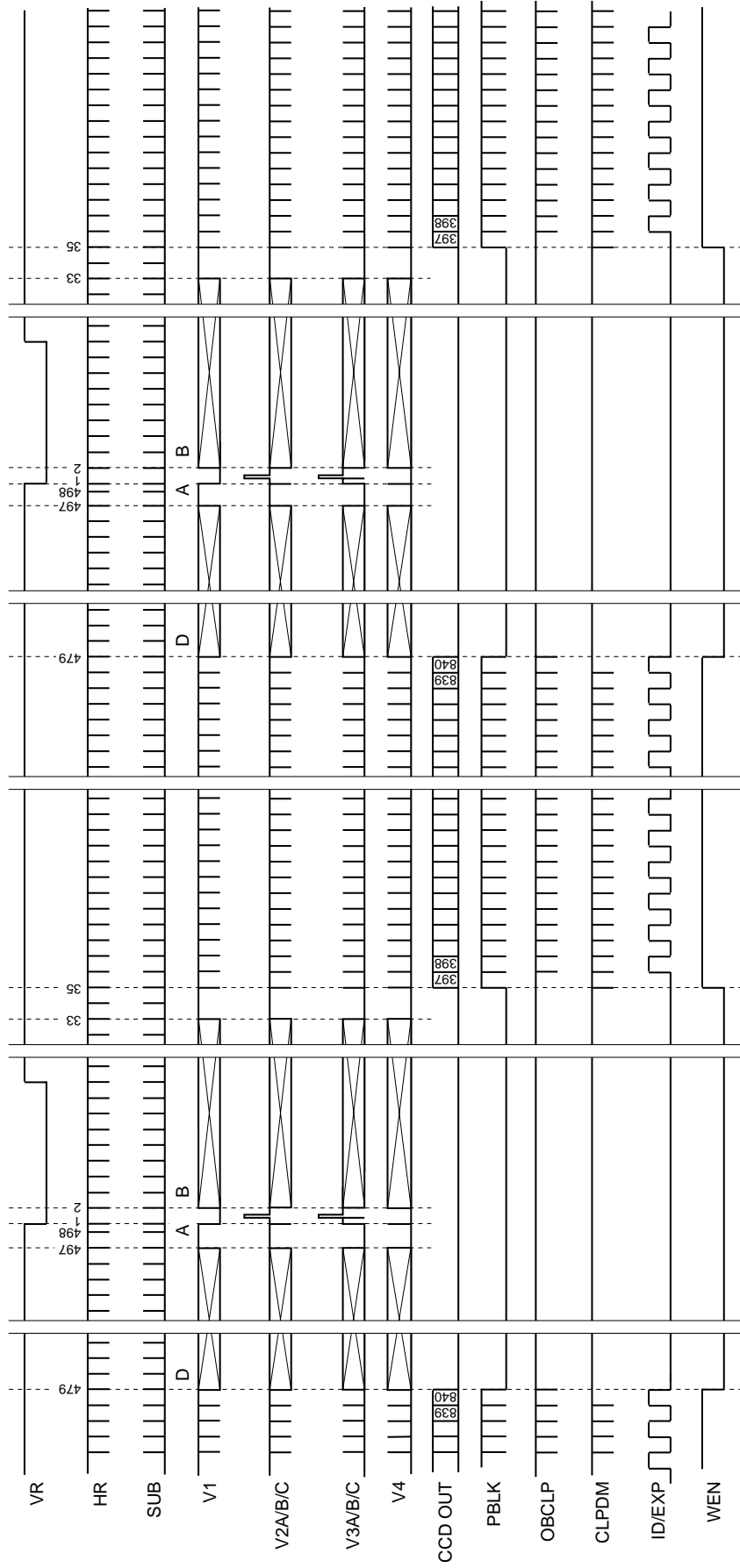

* The number of SUB pulses is determined by the serial interface data. This chart shows the case where SUB pulses are output in all horizontal periods.
* ID/EXP of this chart shows ID. ID is low for lines where CCD OUT contains the R component, and high for lines where CCD OUT contains the B component.
* At 498H one horizontal period is 1260ck.

Chart-7.1 Vertical Direction Timing Chart

MODE

Center scan 3 mode 36MHz drive

Applicable CCD image sensor

- ICX274

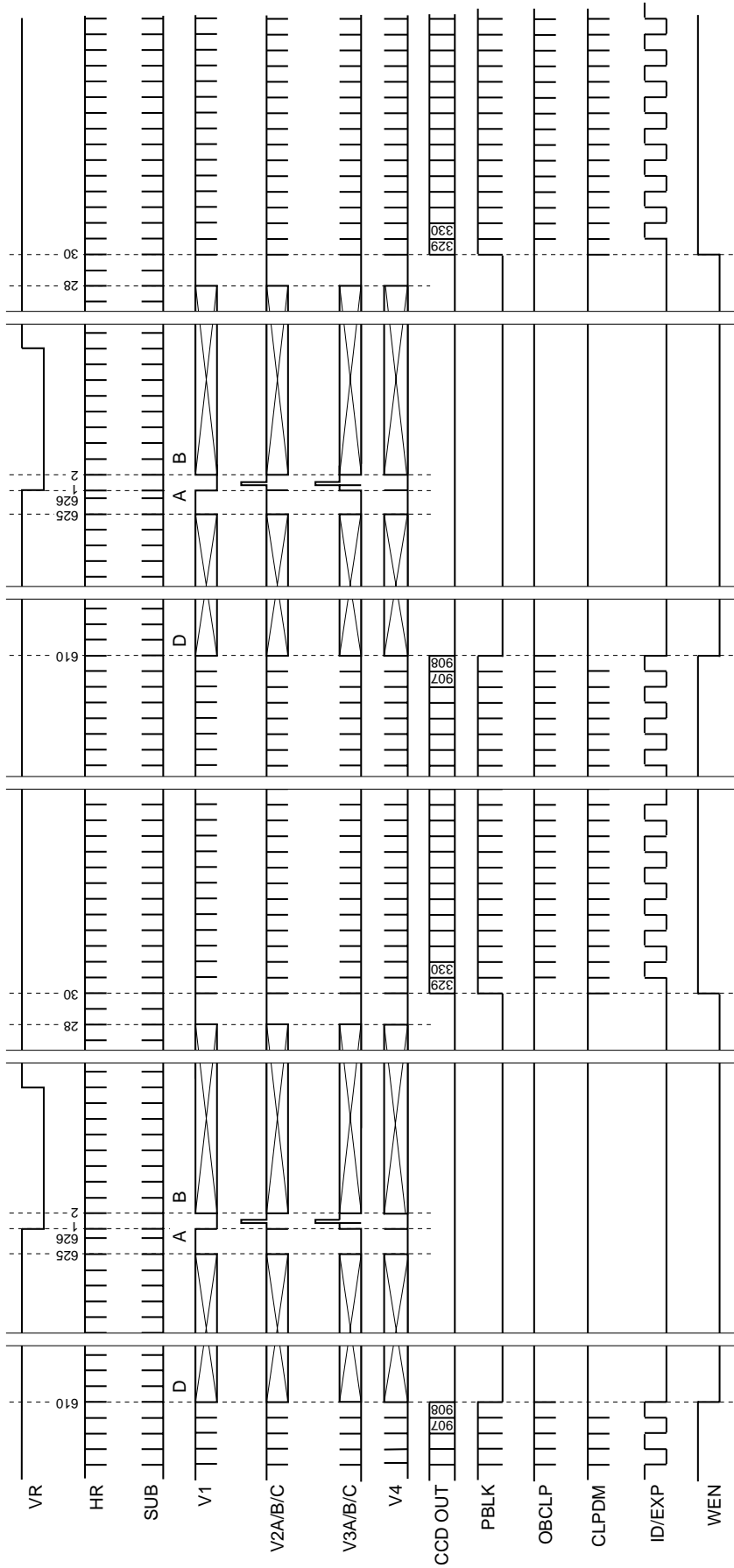

* The number of SUB pulses is determined by the serial interface data. This chart shows the case where SUB pulses are output in all horizontal periods.
 * ID/EXP of this chart shows ID. ID is low for lines where CCD OUT contains the R component, and high for lines where CCD OUT contains the B component.
 * At 626H one horizontal period is 1200ck.

Chart-8 Vertical Direction Timing Chart
MODE
 AF1 mode 28MHz drive

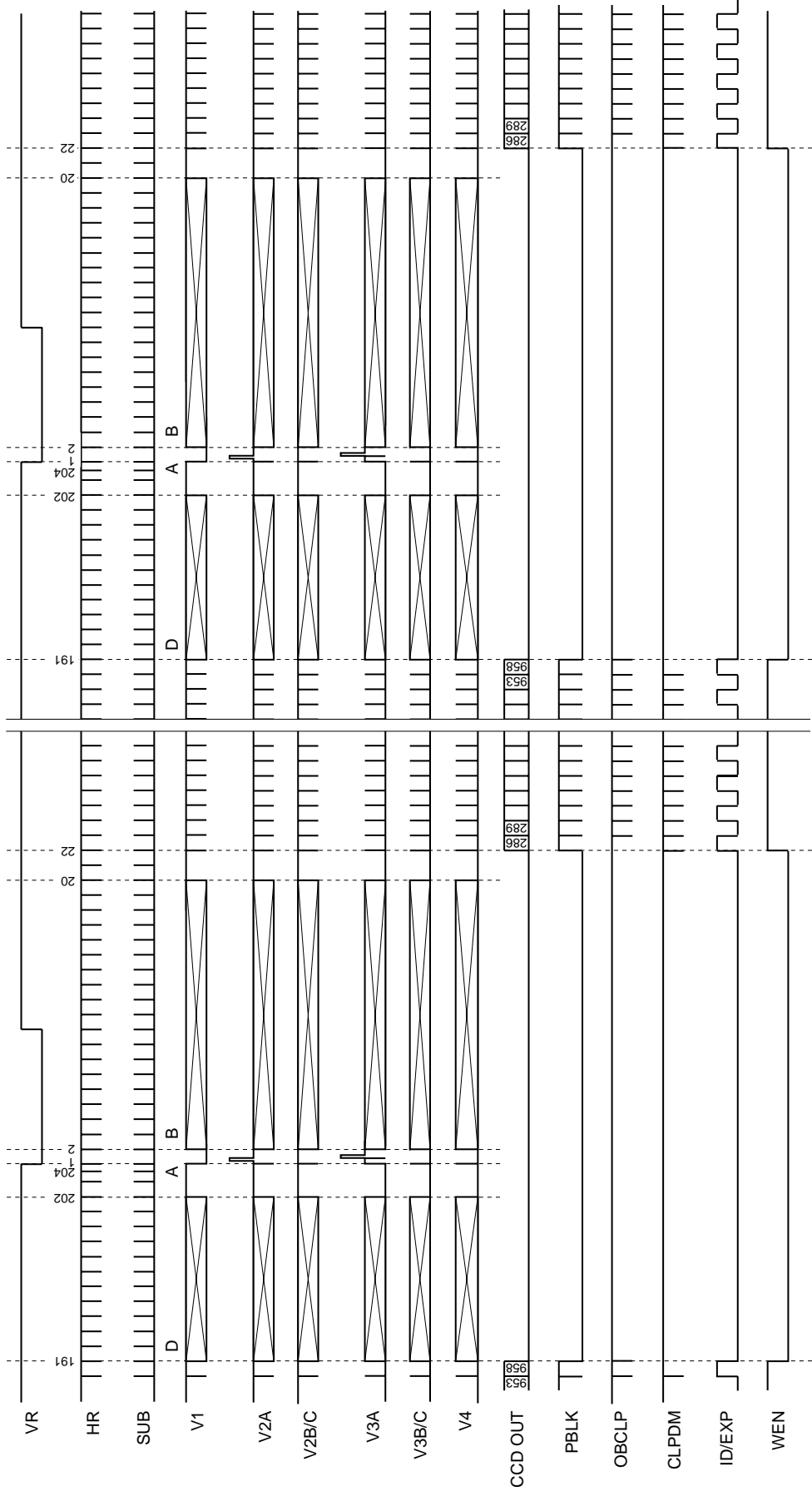

* The number of SUB pulses is determined by the serial interface data. This chart shows the case where SUB pulses are output in all horizontal periods.
 * ID/EXP of this chart shows ID. ID is low for lines where CCD OUT contains the R component, and high for lines where CCD OUT contains the B component.
 * At 203H and 204H one horizontal period is 1323ck.

Chart-8.1 Vertical Direction Timing Chart
MODE
 AF1 mode 36MHz drive

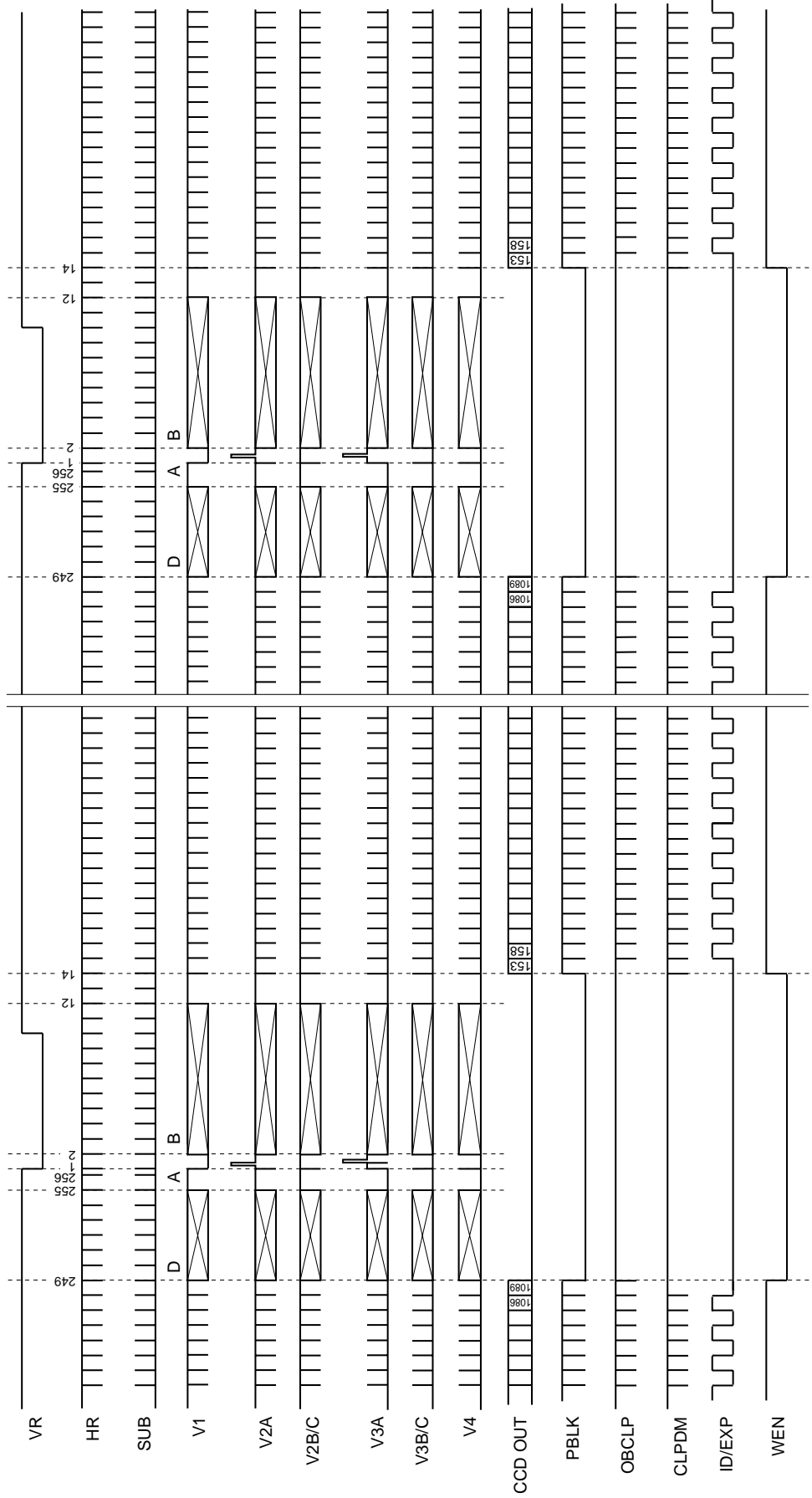

* The number of SUB pulses is determined by the serial interface data. This chart shows the case where SUB pulses are output in all horizontal periods.
 * ID/EXP of this chart shows ID. ID is low for lines where CCD OUT contains the R component, and high for lines where CCD OUT contains the B component.
 * At 256H one horizontal period is 840ck.

Chart-9 Vertical Direction Timing Chart

MODE

AF2 mode 28MHz drive

Applicable CCD image sensor
• ICX274

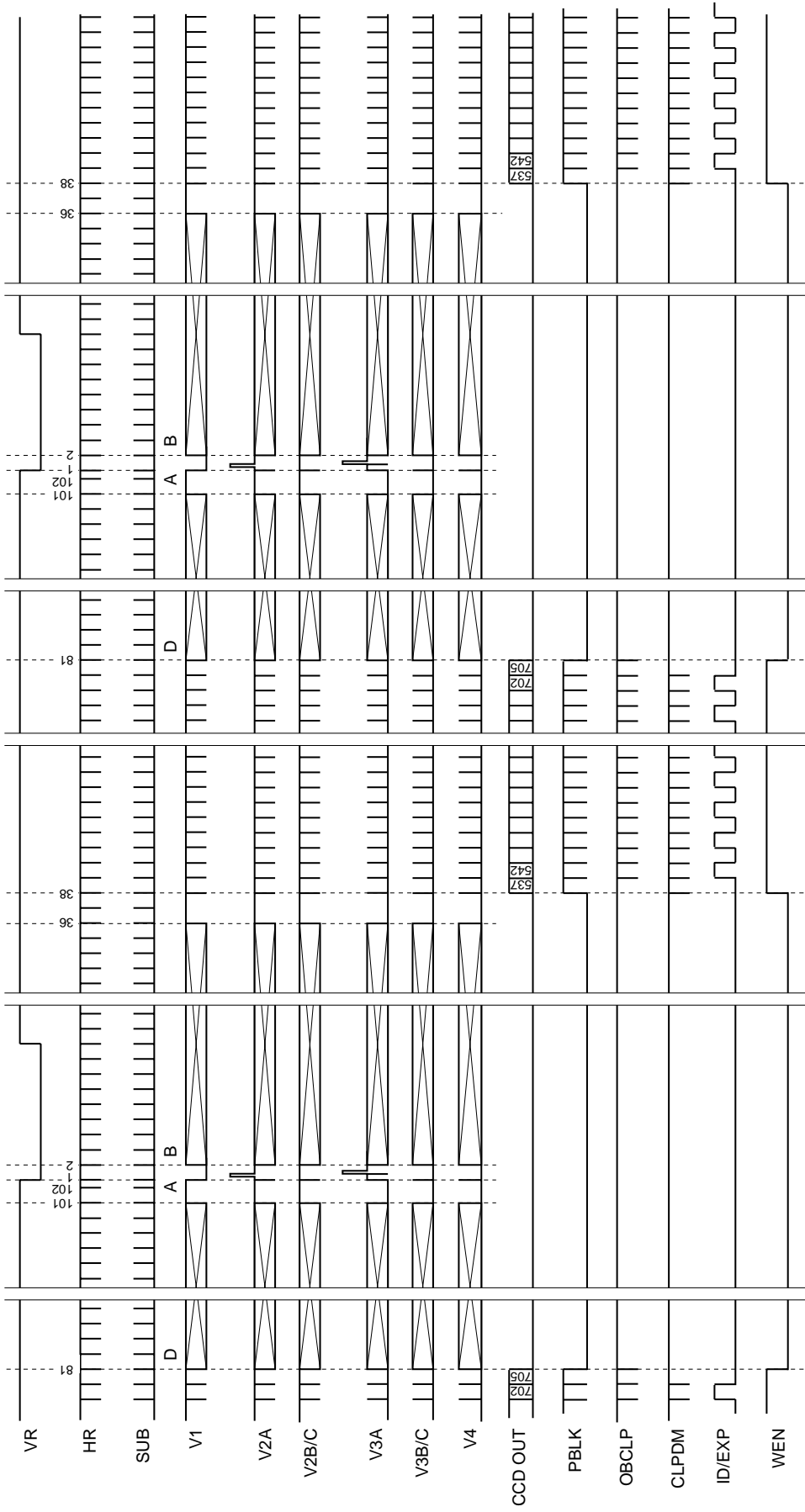

* The number of SUB pulses is determined by the serial interface data. This chart shows the case where SUB pulses are output in all horizontal periods.
 * ID/EXP of this chart shows ID. ID is low for lines where CCD OUT contains the R component, and high for lines where CCD OUT contains the B component.
 * At 102H one horizontal period is 1323ck.

Chart-9.1 Vertical Direction Timing Chart

MODE

AF2 mode 36MHz drive

Applicable CCD image sensor

- ICX274

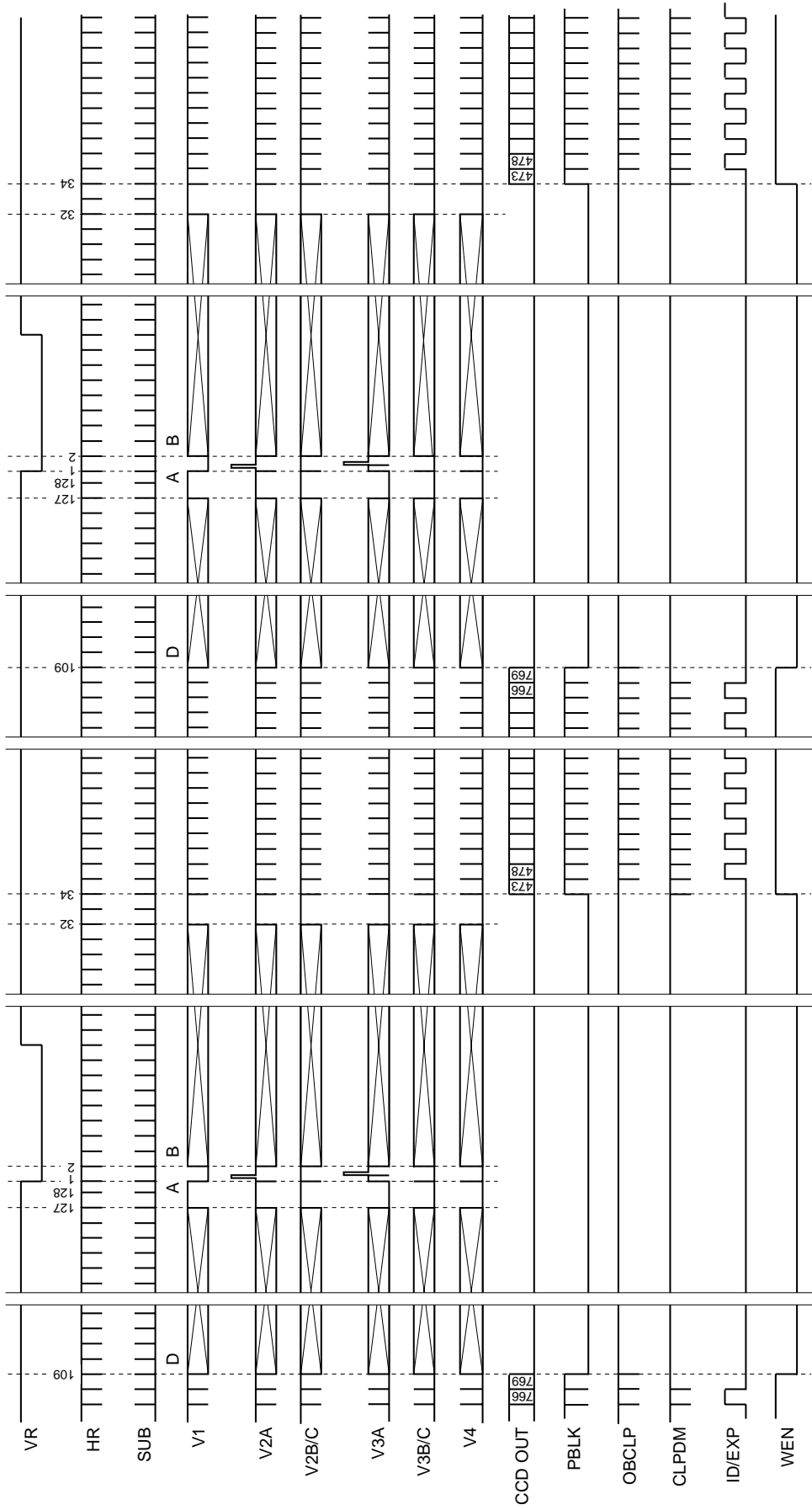

* The number of SUB pulses is determined by the serial interface data. This chart shows the case where SUB pulses are output in all horizontal periods.

* ID/EXP of this chart shows ID. ID is low for lines where CCD OUT contains the R component, and high for lines where CCD OUT contains the B component.

* At 128H one horizontal period is 1596ck.

Chart-10 Vertical Direction Timing Chart **MODE**

2-line addition mode 28MHz (36MHz) drive

Applicable CCD image sensor
• ICX274

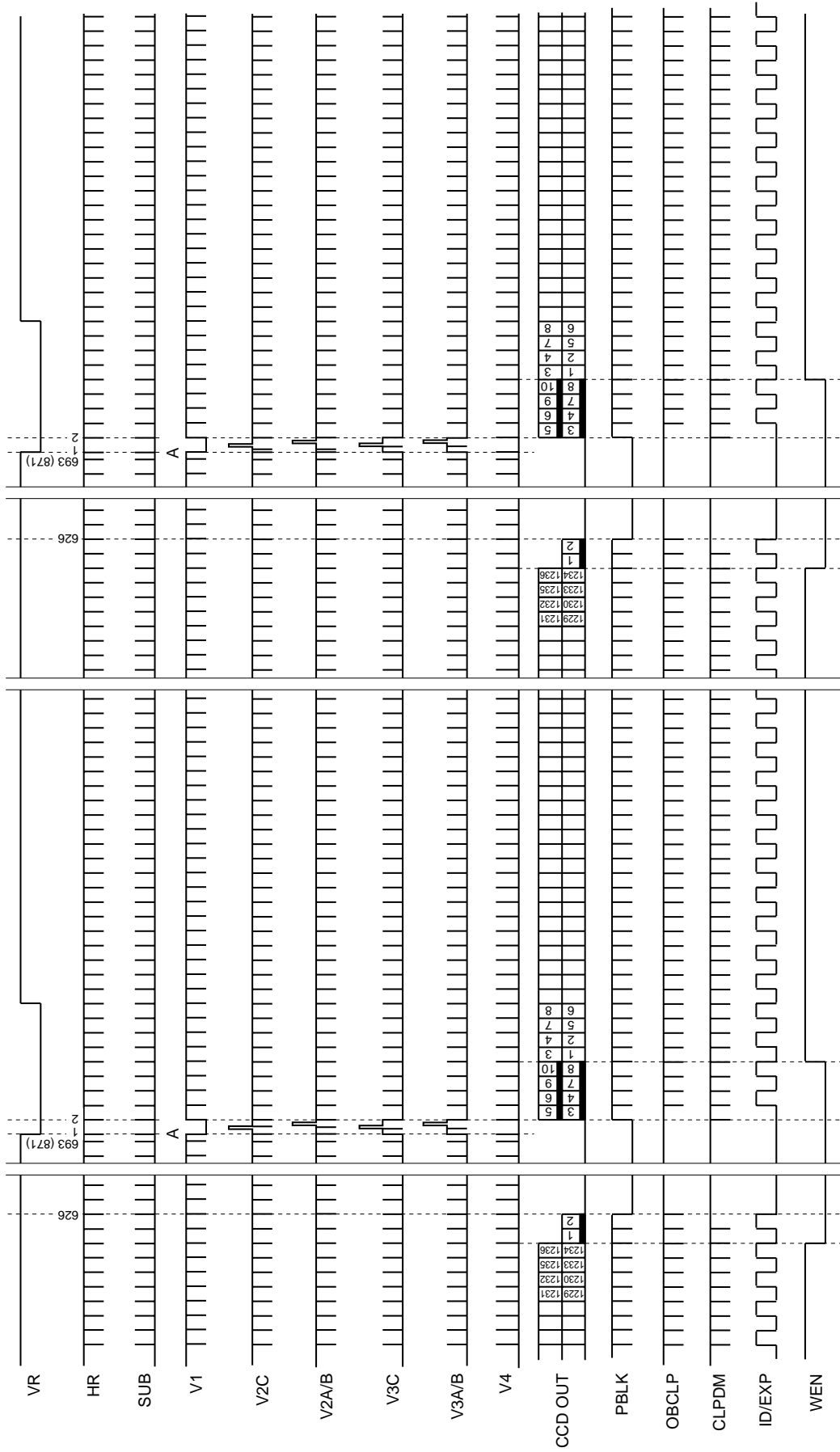

* The number of SUB pulses is determined by the serial interface data. This chart shows the case where SUB pulses are output in all horizontal periods.
 * ID/EXP of this chart shows ID. ID is low for lines where CCD OUT contains the R component, and high for lines where CCD OUT contains the B component.
 * During 28MHz drive, the VR period is 693H, and at 693H one horizontal period is 810ck.
 During 36MHz drive, the VR period is 871H, and at 871H one horizontal period is 900ck.

Chart-11 Horizontal Direction Timing Chart **MODE** **Applicable CCD image sensor**
 Progressive scan mode – high-speed sweep present/not present –
 28MHz (36MHz) drive • ICX274
 Center scan 3 mode 28MHz (36MHz) drive

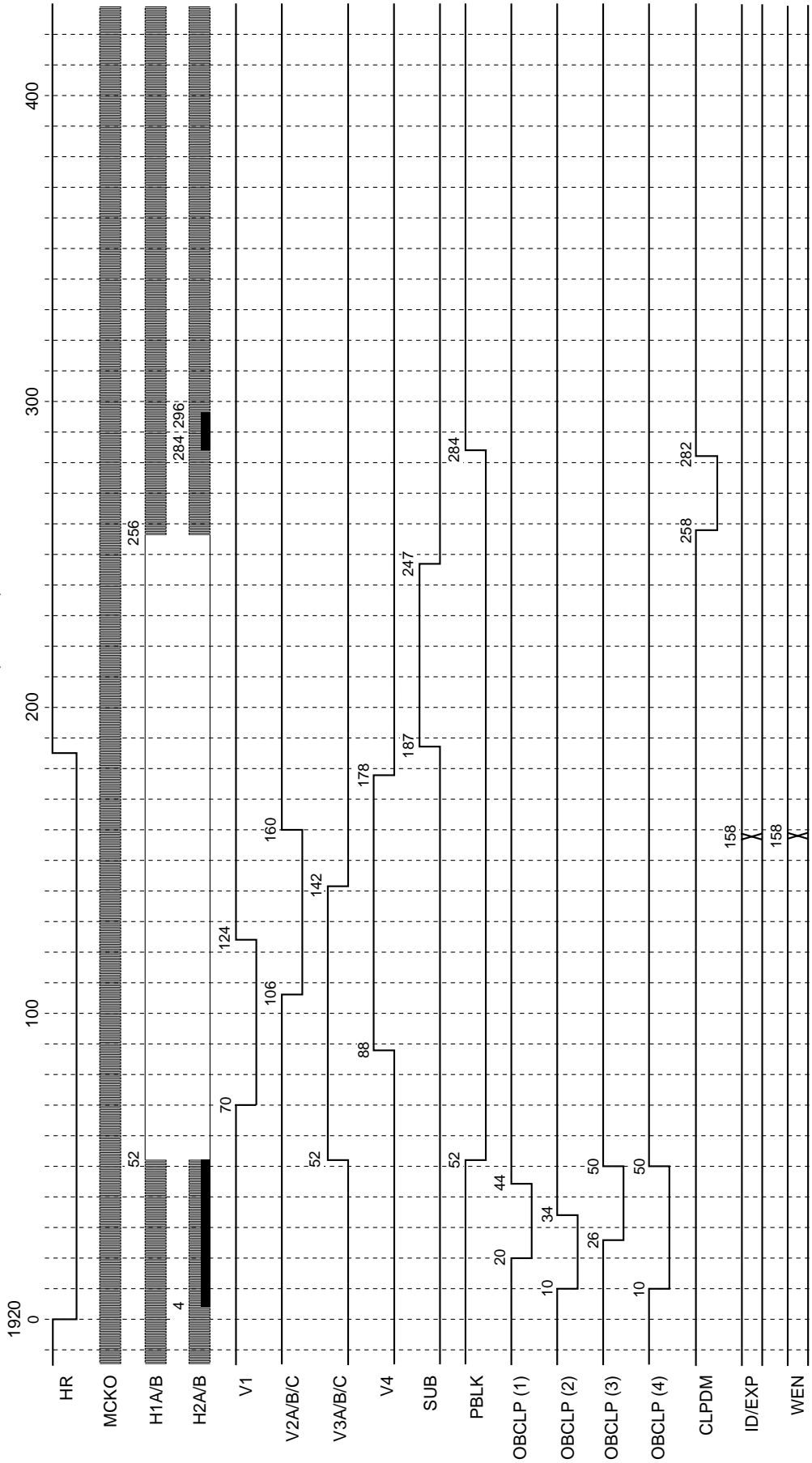

* The HR of this chart indicates the actual CXD3609R load timing.
 * The numbers at the output pulse transition points indicate the count at the MCKO rise from the fall of HR.
 * The HR fall period should be between approximately 5.0 to 28.7µs (when the drive frequency is 28MHz). This chart shows a period of 185ck (6.5µs). The internal SSG operates at this timing.
 * ID/EXP and WEN are output at the timings shown above at the vertical positions shown in Chart-1 and Chart-7.

Chart-12 Horizontal Direction Timing Chart **MODE**
 Monitoring mode 28MHz (36MHz) drive
 AF1 and AF2 mode 28MHz (36MHz) drive

Applicable CCD image sensor
 • ICX274

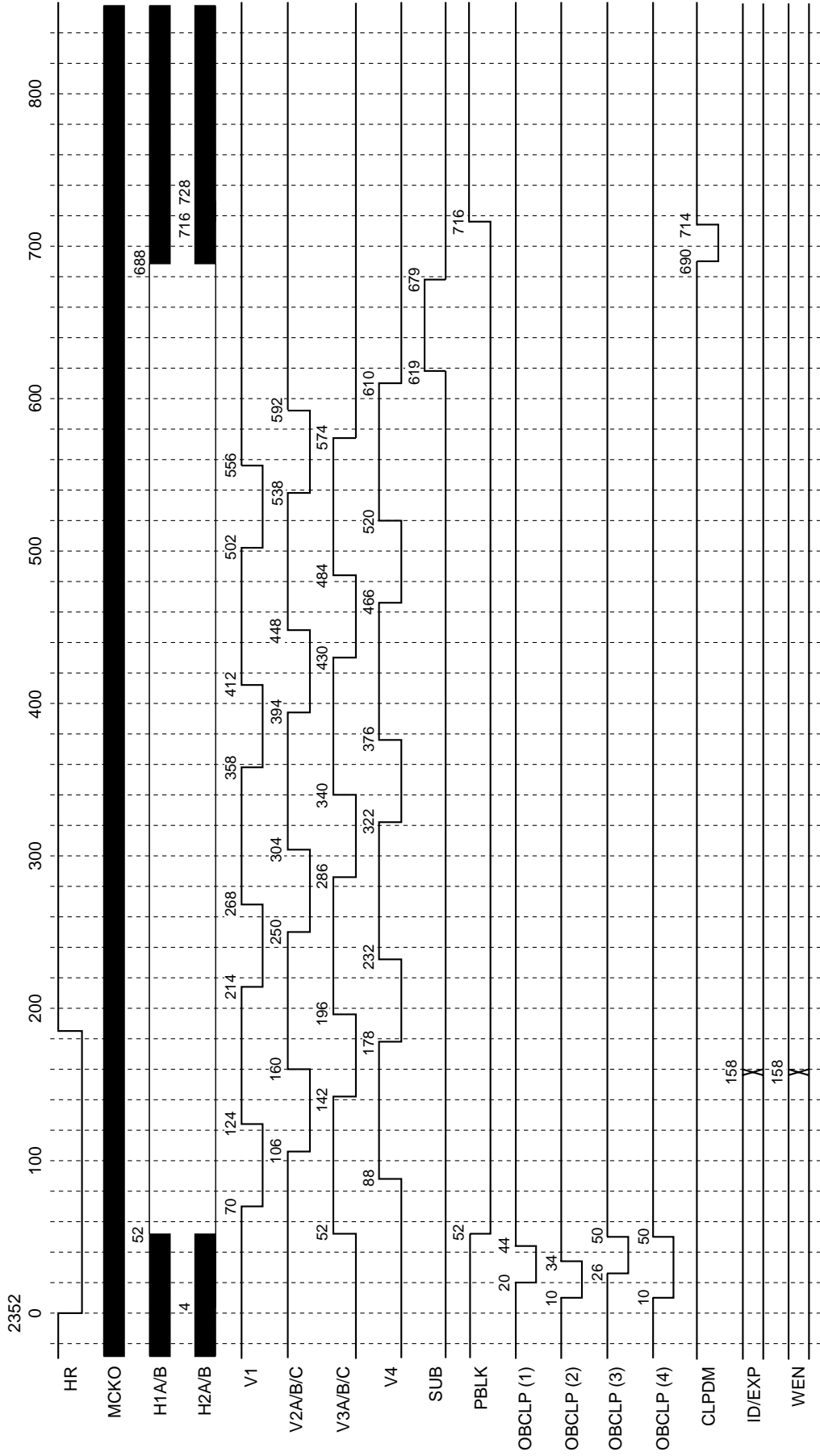

* The HR of this chart indicates the actual CXD3609R load timing.
 * The numbers at the output pulse transition points indicate the count at the MCKO rise from the fall of HR.
 * The HR fall period should be between approximately 5.0 to 28.7µs (when the drive frequency is 28MHz). This chart shows a period of 185ck (6.5µs). The internal SSG operates at this timing.
 * ID/EXP and WEN are output at the timings shown above at the vertical positions shown in Chart-3, Chart-8 and Chart-9.

Chart-13 Horizontal Direction Timing Chart **MODE**

Applicable CCD image sensor
 • ICX274

Draft mode 28MHz (36MHz) drive
 2-line addition mode 28MHz (36MHz) drive
 Center scan 1 and center scan 2 mode 28MHz (36MHz) drive

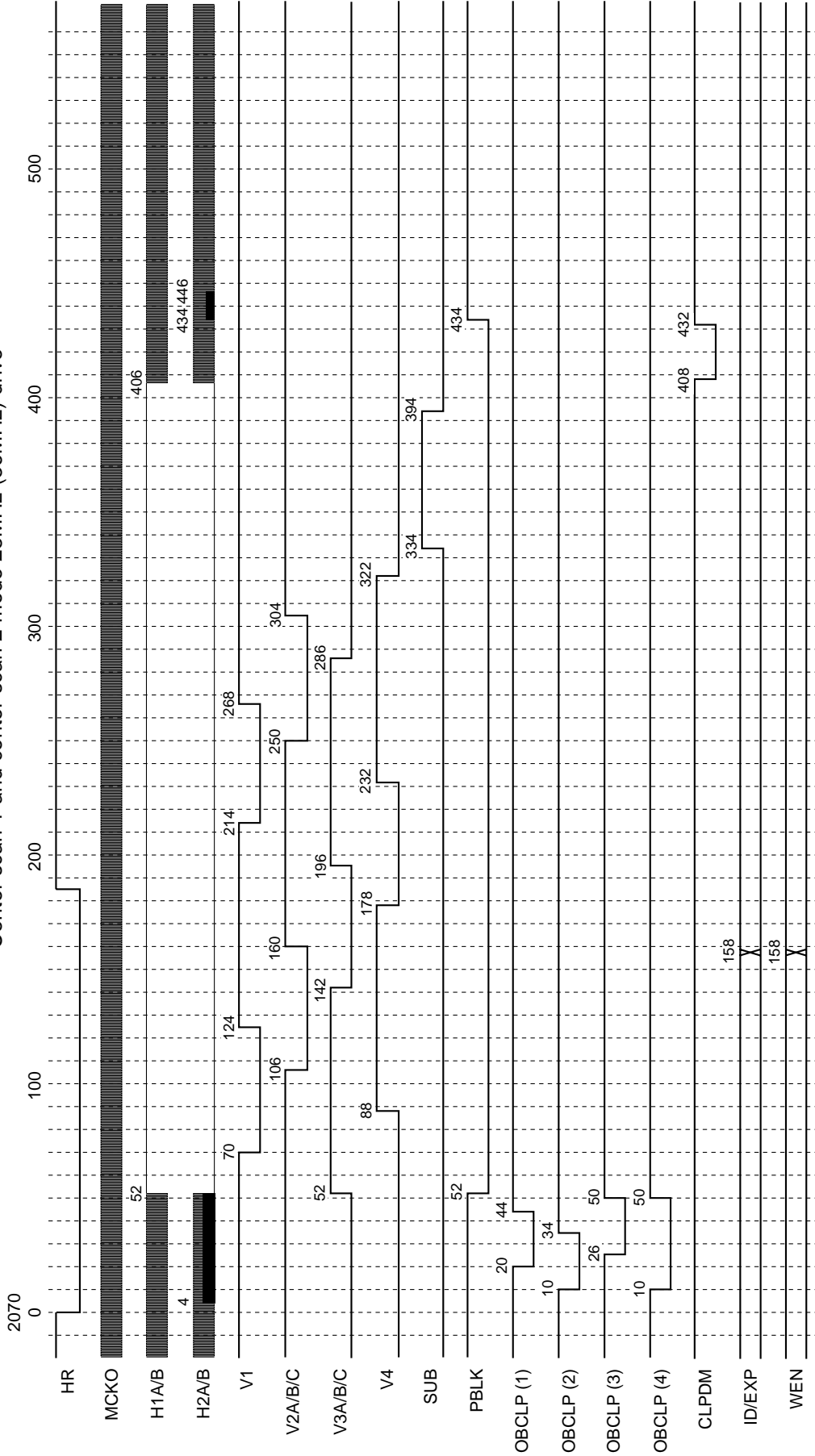

* The HR of this chart indicates the actual CXD3609R load timing.
 * The numbers at the output pulse transition points indicate the count at the MCKO rise from the fall of HR.
 * The HR fall period should be between approximately 5.0 to 28.7µs (when the drive frequency is 28MHz). This chart shows a period of 185ck (6.5µs). The internal SSG operates at this timing.
 * ID/EXP and WEN are output at the timings shown above at the vertical positions shown in Chart-2, Chart-5, Chart-6 and Chart-10.

Chart-14 Horizontal Direction Timing Chart **MODE** **Applicable CCD image sensor**
(D: high-speed sweep) **Progressive scan mode – high-speed sweep present –** **• ICX274**
28MHz (36MHz) drive

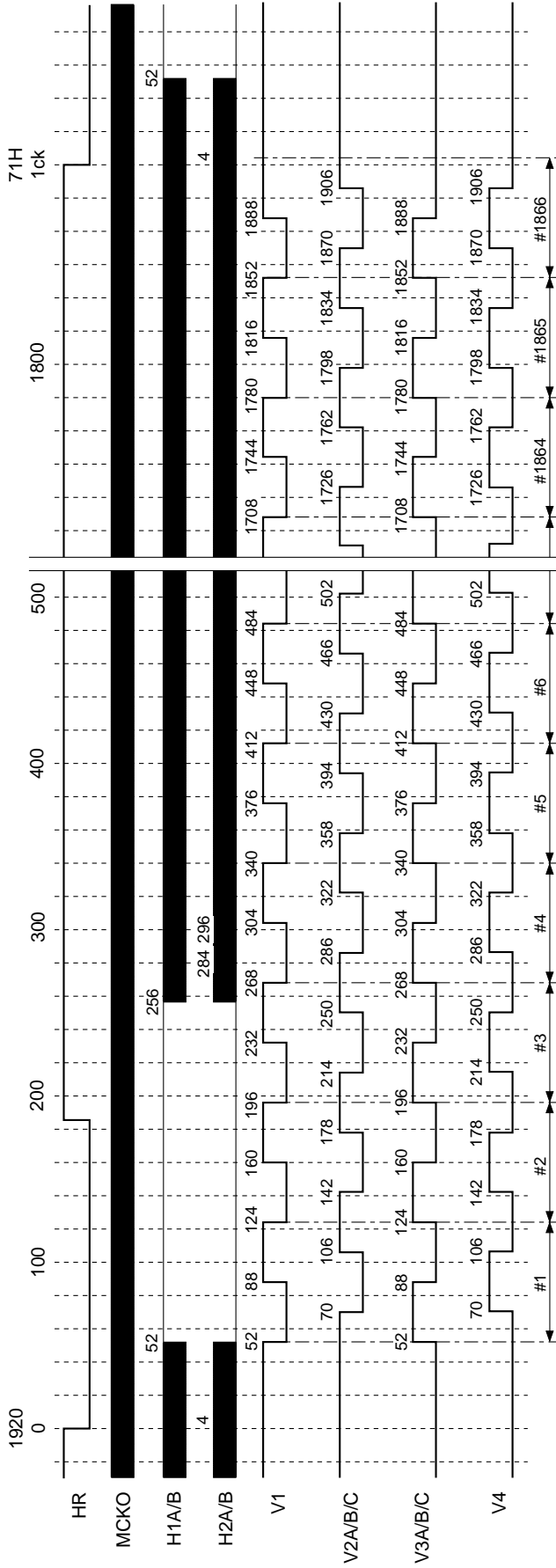

* The HR of this chart indicates the actual CXD3609R load timing.
 * The numbers at the output pulse transition points indicate the count at the MCKO rise from the fall of HR.
 * The HR fall period should be between approximately 5.0 to 28.7 μs (when the drive frequency is 28MHz).
 This chart shows a period of 1850 μs (6.5 μs). The internal SSG operates at this timing.

Chart-15 Horizontal Direction Timing Chart **MODE** **Applicable CCD image sensor**
(D: high-speed sweep) **Center scan 1 and center scan 2 mode 28MHz drive** **• ICX274**

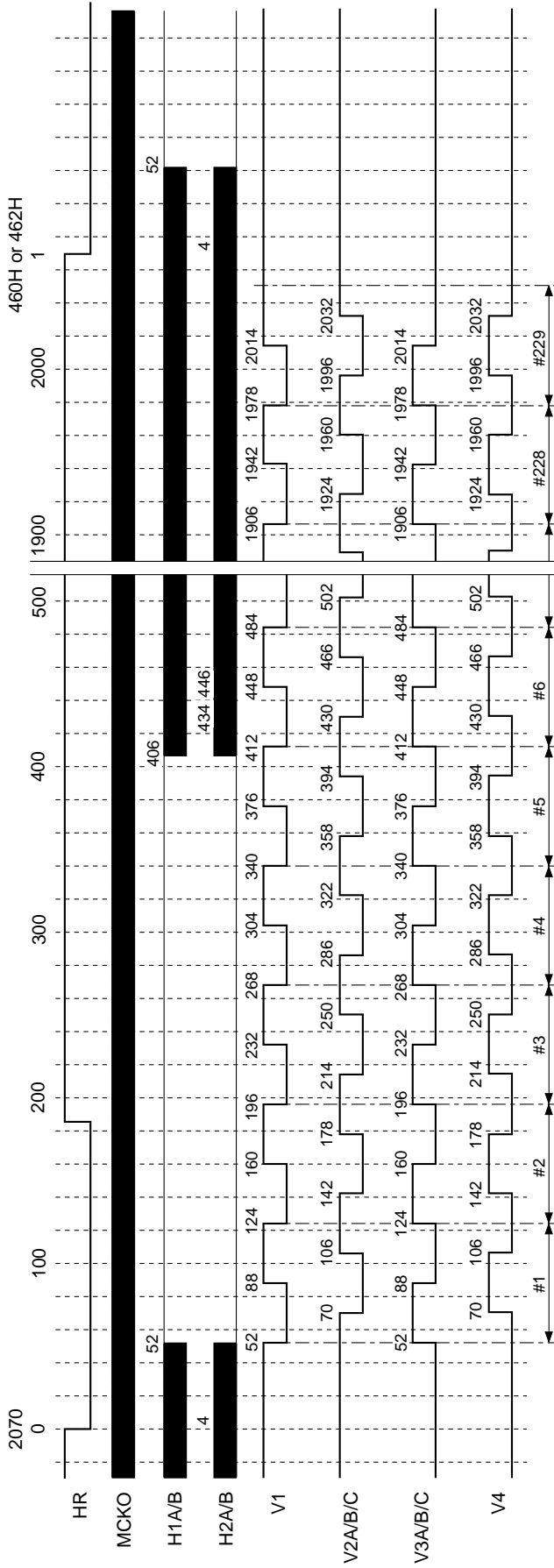

* The HR of this chart indicates the actual CXD3609R load timing.
 * The numbers at the output pulse transition points indicate the count at the MCKO rise from the fall of HR.
 * The HR fall period should be between approximately 5.0 to 28.7μs (when the drive frequency is 28MHz).
 This chart shows a period of 185ck (6.5μs). The internal SSG operates at this timing.

Chart-15.1 Horizontal Direction Timing Chart **MODE** **Applicable CCD image sensor**
 (D: high-speed sweep) **Center scan 1 and center scan 2 mode 36MHz drive** • ICX274

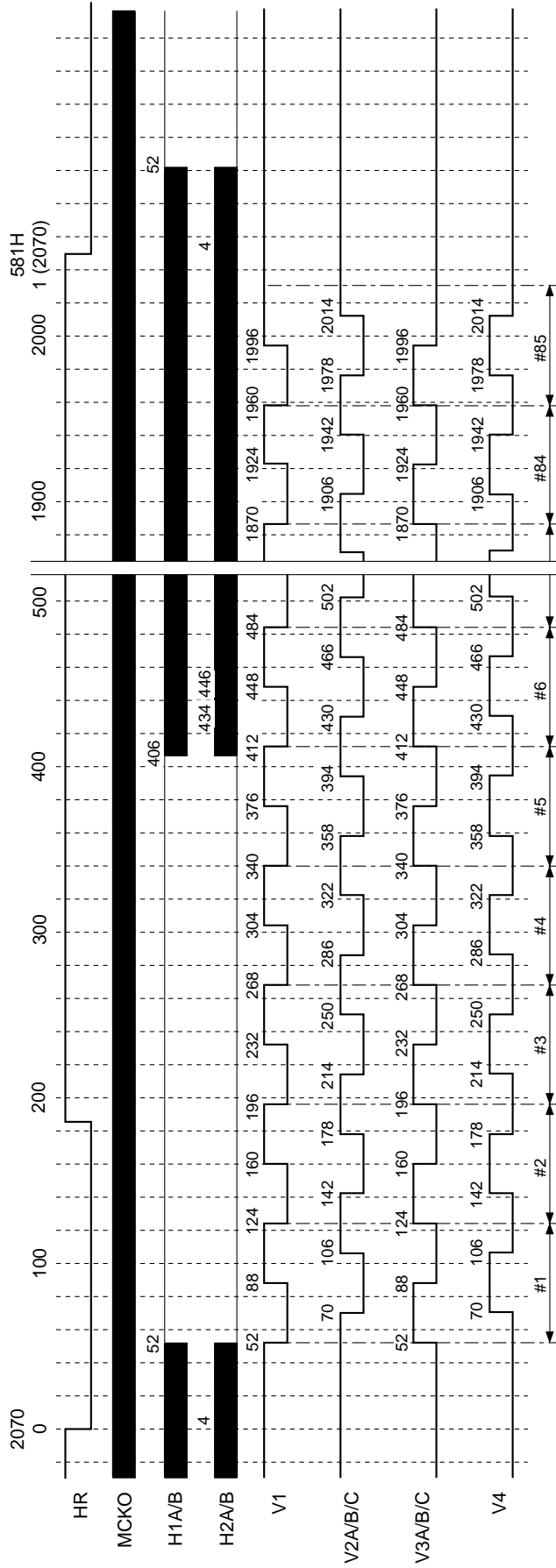

* The HR of this chart indicates the actual CXD3609R load timing.
 * The numbers at the output pulse transition points indicate the count at the MCKO rise from the fall of HR.
 * The HR fall period should be between approximately 5.0 to 28.7μs (when the drive frequency is 28MHz).
 This chart shows a period of 185ck (6.5μs). The internal SSG operates at this timing.

Chart-16 Horizontal Direction Timing Chart **MODE** Applicable CCD image sensor
 (D: high-speed sweep) Center scan 3 mode 28MHz drive • ICX274

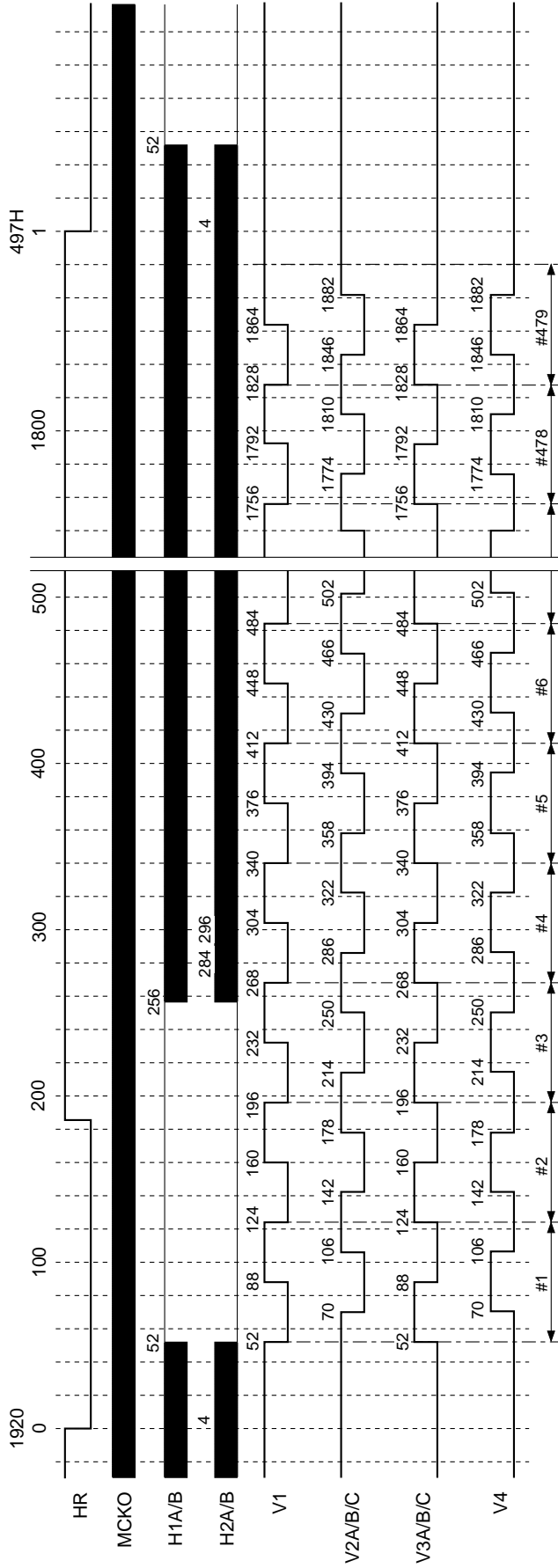

* The HR of this chart indicates the actual CXD3609R load timing.
 * The numbers at the output pulse transition points indicate the count at the MCKO rise from the fall of HR.
 * The HR fall period should be between approximately 5.0 to 28.7μs (when the drive frequency is 28MHz).
 This chart shows a period of 185clk (6.5μs). The internal SSG operates at this timing.

Chart-16.1 Horizontal Direction Timing Chart **MODE** **Applicable CCD image sensor**
 (D: high-speed sweep) **Center scan 3 mode 36MHz drive** • ICX274

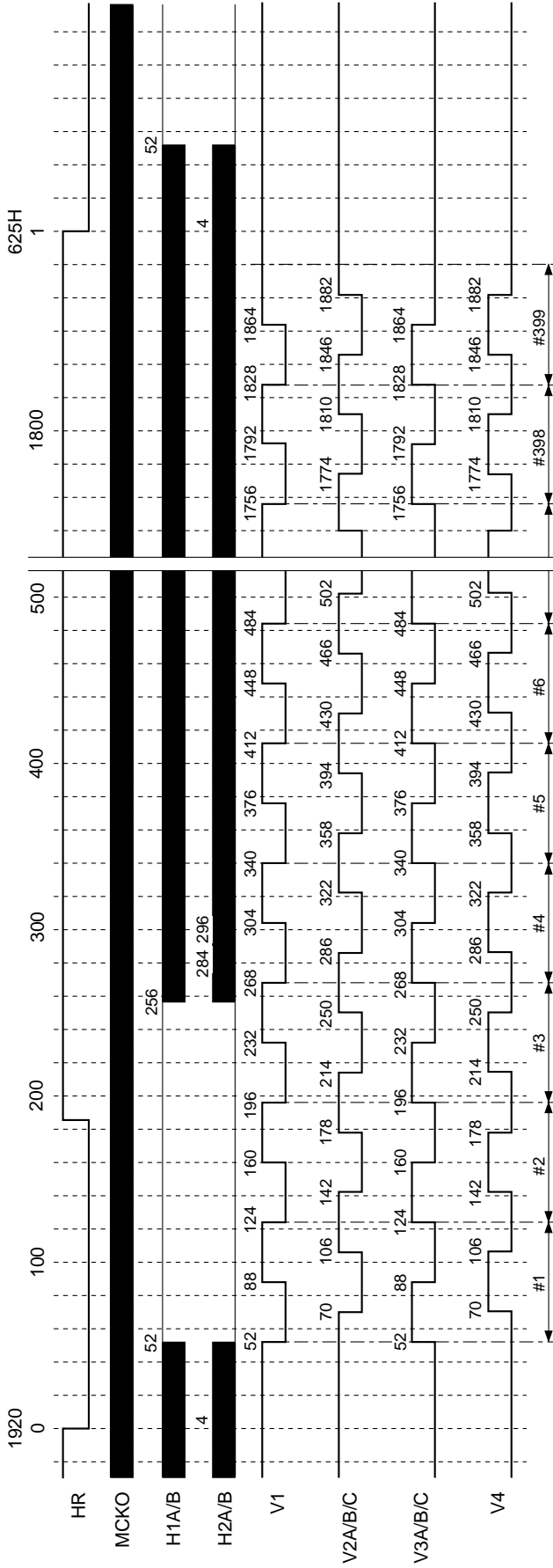

* The HR of this chart indicates the actual CXD3609R load timing.
 * The numbers at the output pulse transition points indicate the count at the MCKO rise from the fall of HR.
 * The HR fall period should be between approximately 5.0 to 28.7µs (when the drive frequency is 28MHz).
 This chart shows a period of 185ck (6.5µs). The internal SSG operates at this timing.

Chart-17 Horizontal Direction Timing Chart **MODE** **Applicable CCD image sensor**
 (D: high-speed sweep) AF1 mode, 28MHz drive • ICX274

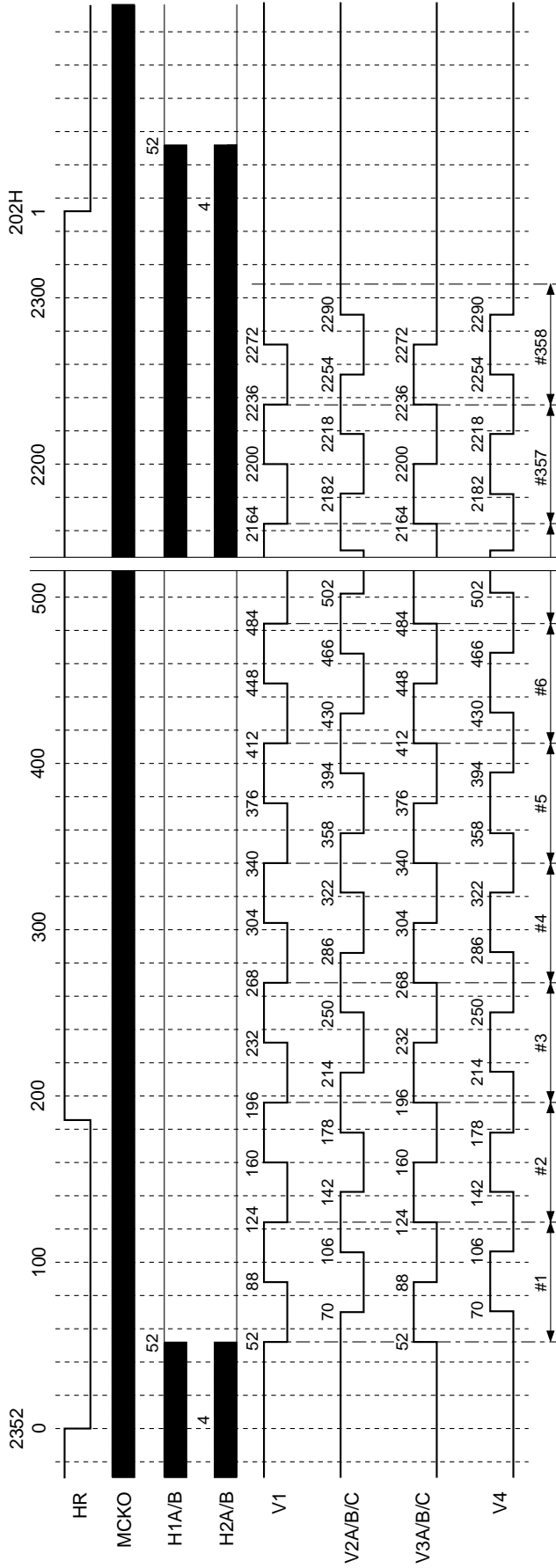

* The HR of this chart indicates the actual CXD3609R load timing.
 * The numbers at the output pulse transition points indicate the count at the MCKO rise from the fall of HR.
 * The HR fall period should be between approximately 5.0 to 28.7μs (when the drive frequency is 28MHz).
 This chart shows a period of 185ck (6.5μs). The internal SSG operates at this timing.

Chart-17.1 Horizontal Direction Timing Chart **MODE** **Applicable CCD image sensor**
 (D: high-speed sweep) AF1 mode, 36MHz drive • ICX274

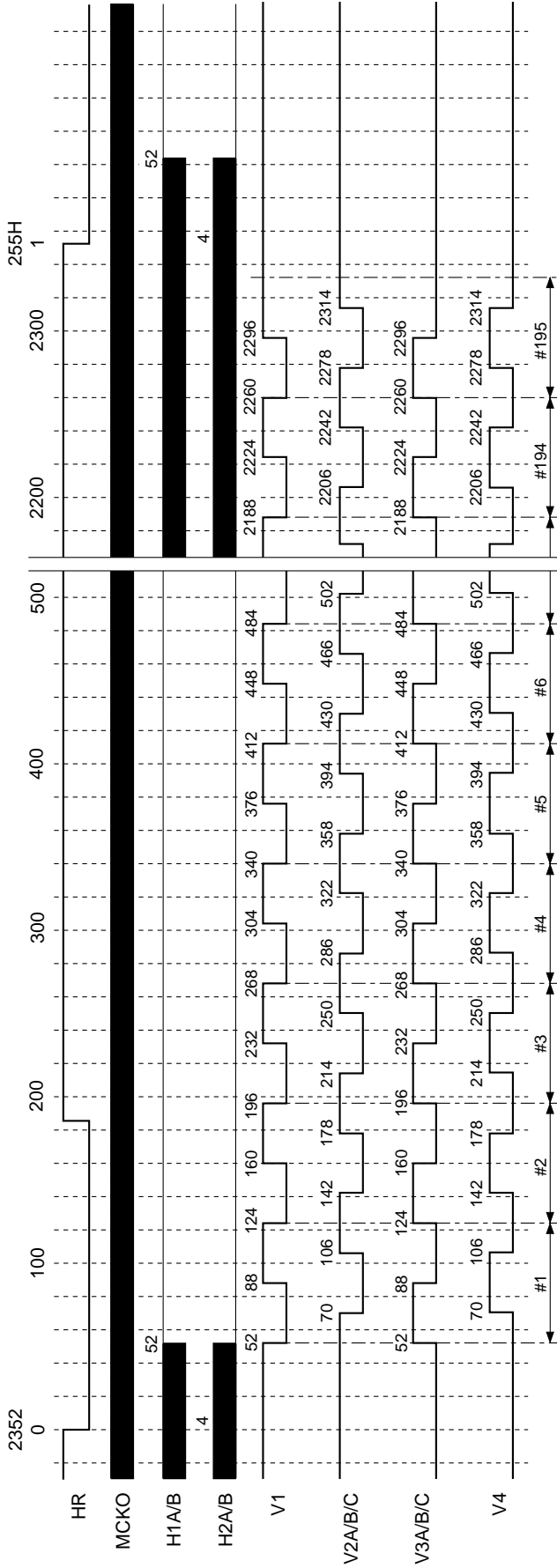

* The HR of this chart indicates the actual CXD3609R load timing.
 * The numbers at the output pulse transition points indicate the count at the MCKO rise from the fall of HR.
 * The HR fall period should be between approximately 5.0 to 28.7μs (when the drive frequency is 28MHz).
 This chart shows a period of 185ck (6.5μs). The internal SSG operates at this timing.

Chart-18 Horizontal Direction Timing Chart **MODE** **Applicable CCD image sensor**
(D: high-speed sweep) **AF2 mode, 28MHz drive** **• ICX274**

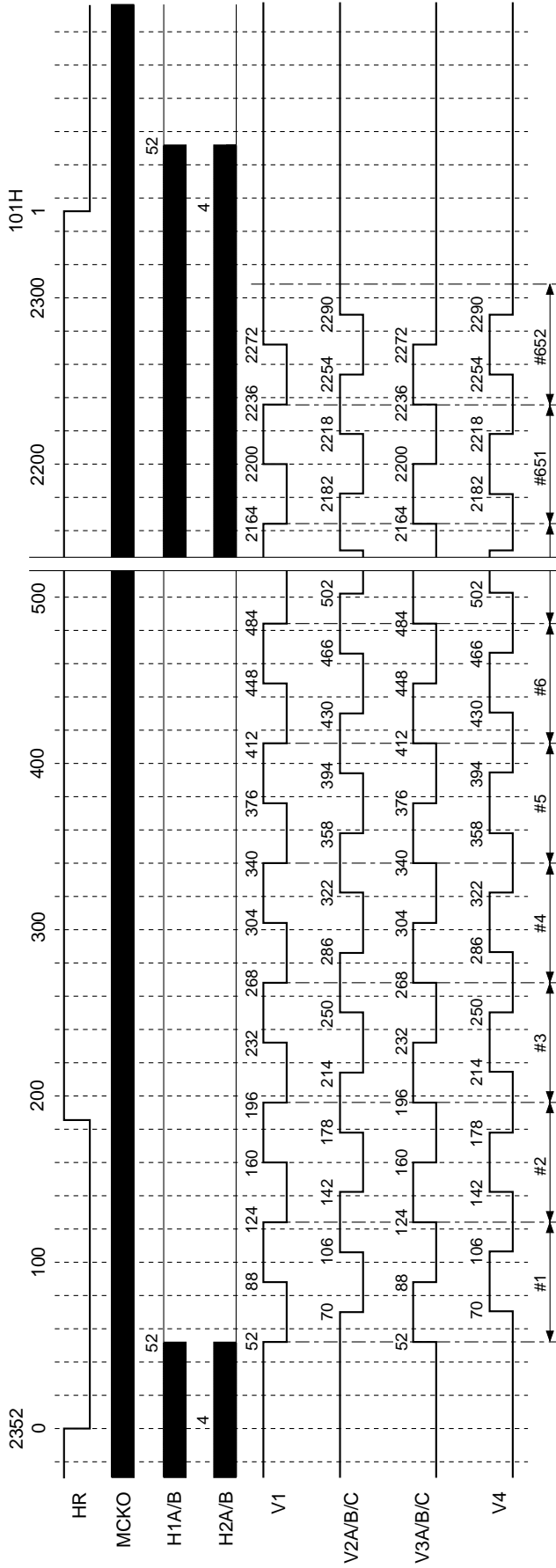

* The HR of this chart indicates the actual CXD3609R load timing.
 * The numbers at the output pulse transition points indicate the count at the MCKO rise from the fall of HR.
 * The HR fall period should be between approximately 5.0 to 28.7μs (when the drive frequency is 28MHz).
 This chart shows a period of 185clk (6.5μs). The internal SSG operates at this timing.

Chart-19 Horizontal Direction Timing Chart **MODE** **Applicable CCD image sensor**
(B: frame shift) **Center scan 1 and center scan 2 mode 28MHz drive** • ICX274

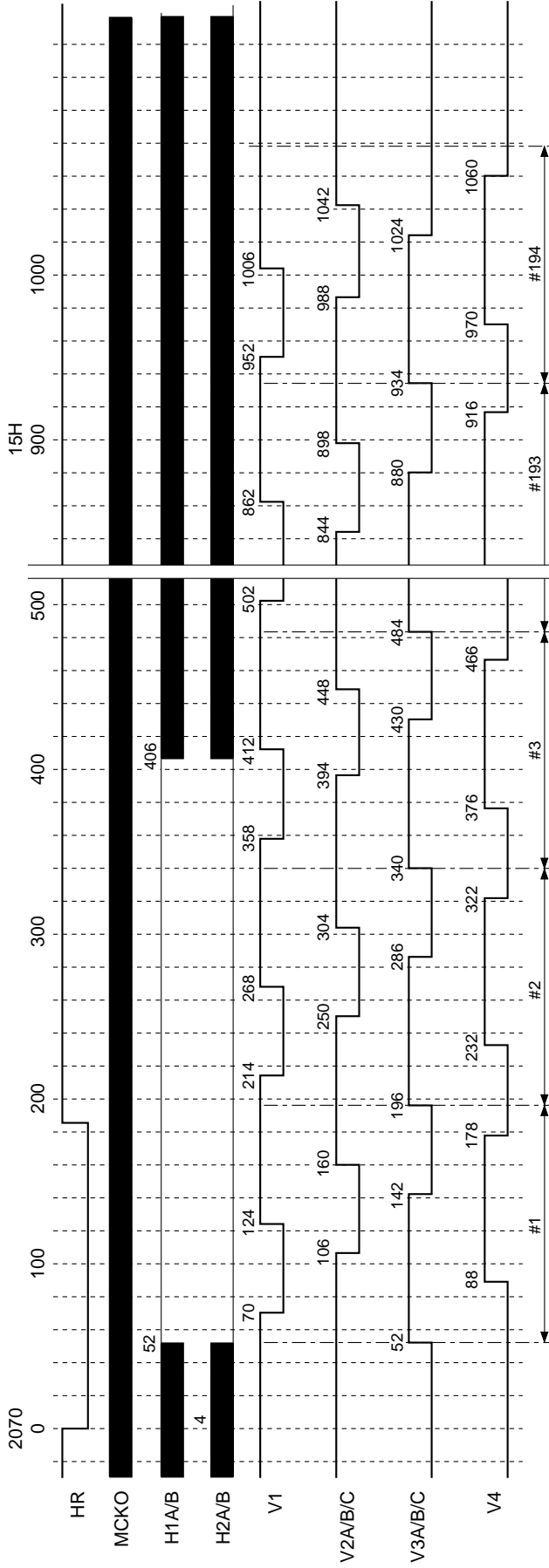

* The HR of this chart indicates the actual CXD3609R load timing.
 * The numbers at the output pulse transition points indicate the count at the MCKO rise from the fall of HR.
 * The HR fall period should be between approximately 5.0 to 28.7μs (when the drive frequency is 28MHz).
 This chart shows a period of 185ck (6.5μs). The internal SSG operates at this timing.

Chart-19.1 Horizontal Direction Timing Chart **MODE** **Applicable CCD image sensor**
 (B: frame shift) Center scan 1 and center scan 2 mode 36MHz drive • ICX274

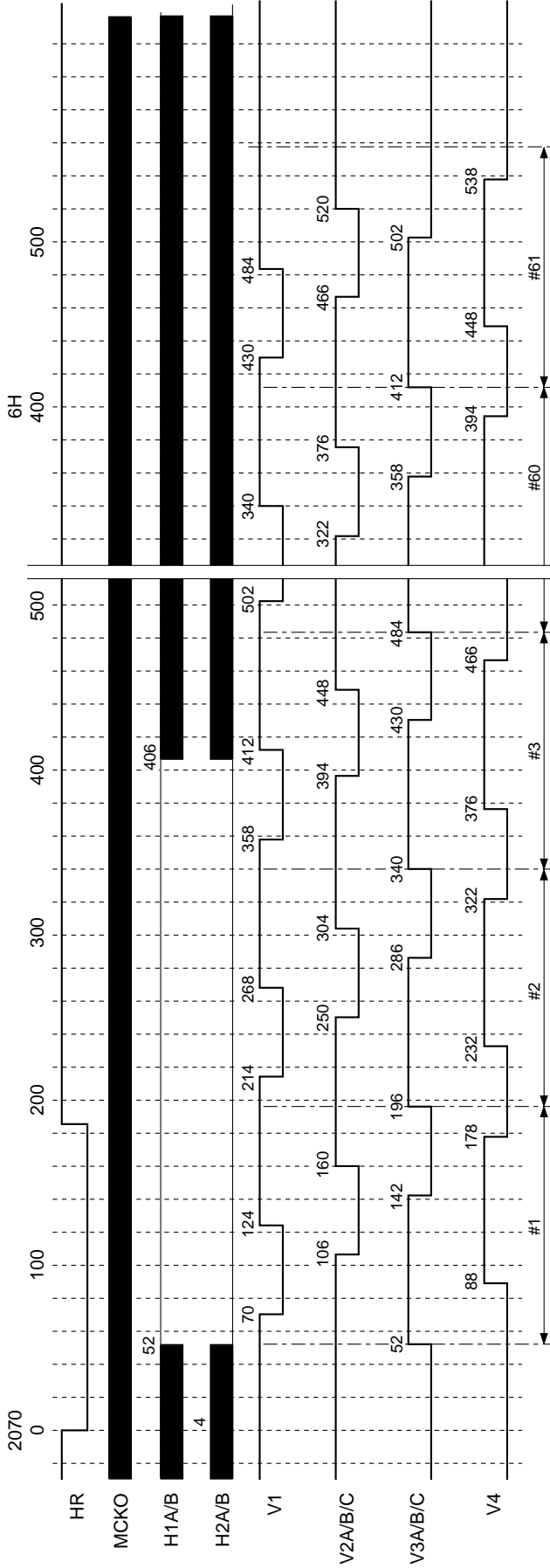

* The HR of this chart indicates the actual CXD3609R load timing.
 * The numbers at the output pulse transition points indicate the count at the MCKO rise from the fall of HR.
 * The HR fall period should be between approximately 5.0 to 28.7μs (when the drive frequency is 28MHz).
 This chart shows a period of 185ck (6.5μs). The internal SSG operates at this timing.

Chart-20 Horizontal Direction Timing Chart **MODE** **Applicable CCD image sensor**
(B: frame shift) **Center scan 3 mode 28MHz drive** **• ICX274**

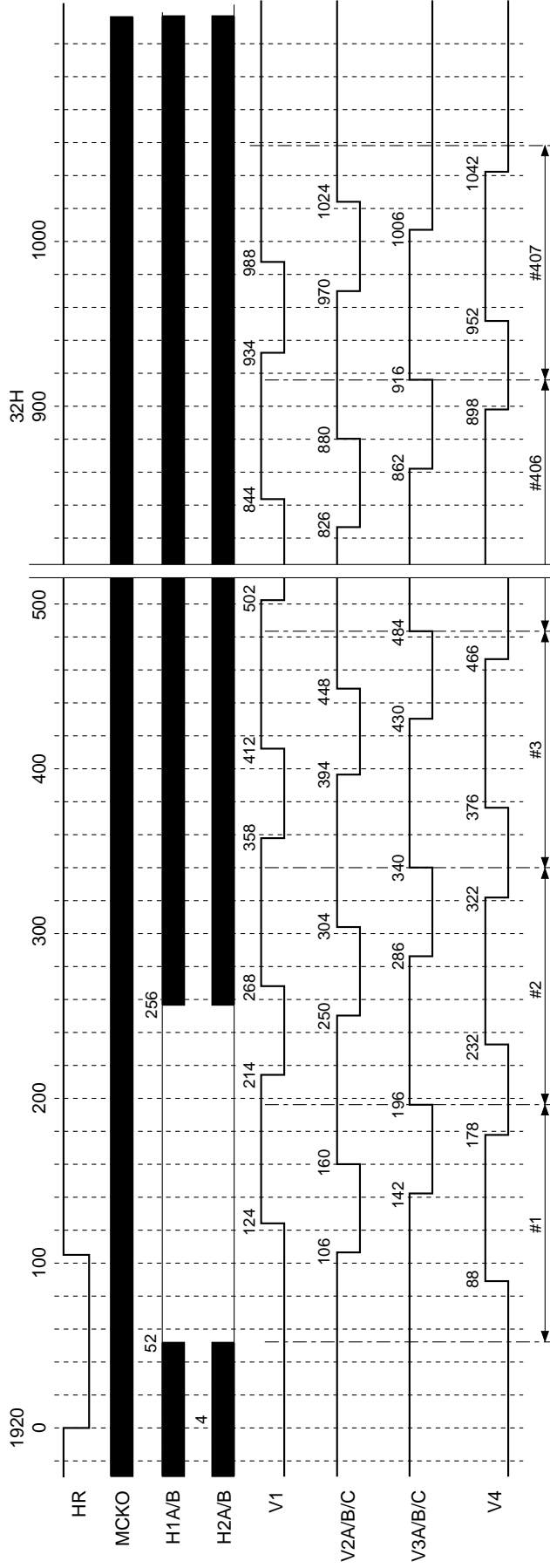

* The HR of this chart indicates the actual CXD3609R load timing.
 * The numbers at the output pulse transition points indicate the count at the MCKO rise from the fall of HR.
 * The HR fall period should be between approximately 5.0 to 28.7μs (when the drive frequency is 28MHz).
 This chart shows a period of 185clk (6.5μs). The internal SSG operates at this timing.

Chart-20.1 Horizontal Direction Timing Chart **MODE** **Applicable CCD image sensor**
 (B: frame shift) Center scan 3 mode 36MHz drive • ICX274

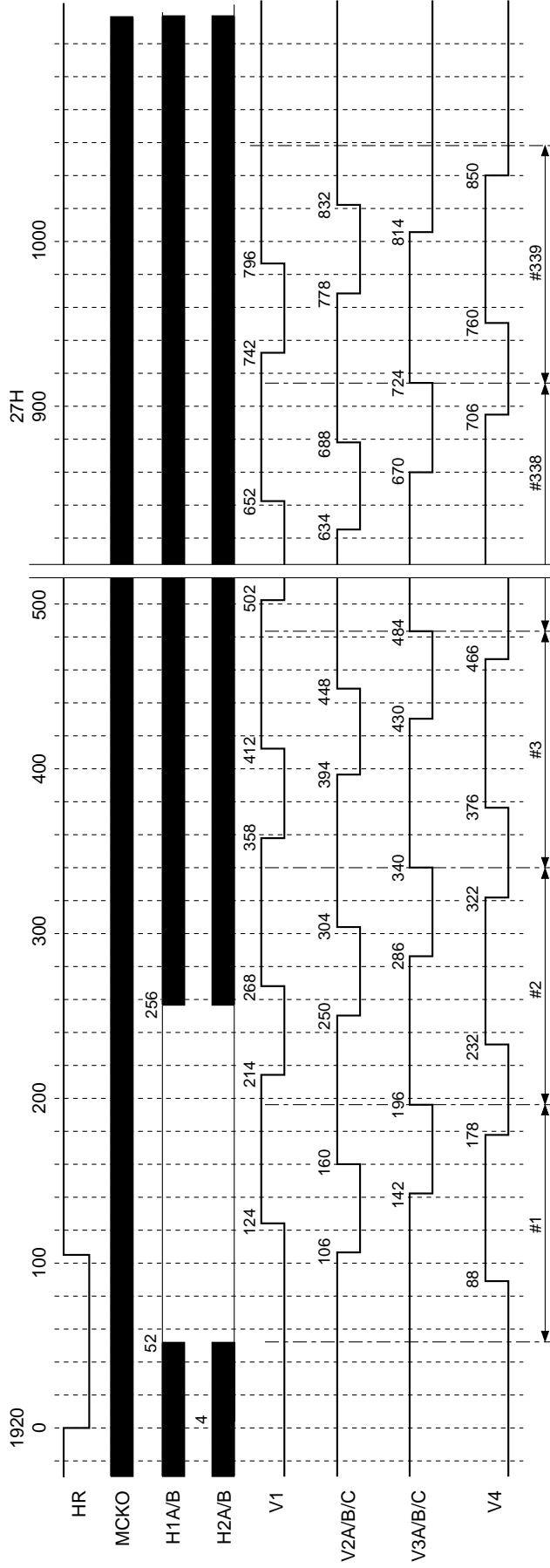

* The HR of this chart indicates the actual CXD3609R load timing.
 * The numbers at the output pulse transition points indicate the count at the MCKO rise from the fall of HR.
 * The HR fall period should be between approximately 5.0 to 28.7μs (when the drive frequency is 28MHz).
 This chart shows a period of 185ck (6.5μs). The internal SSG operates at this timing.

Chart-21 Horizontal Direction Timing Chart **MODE** **Applicable CCD image sensor**
(B: frame shift) AF1 mode, 28MHz drive • ICX274

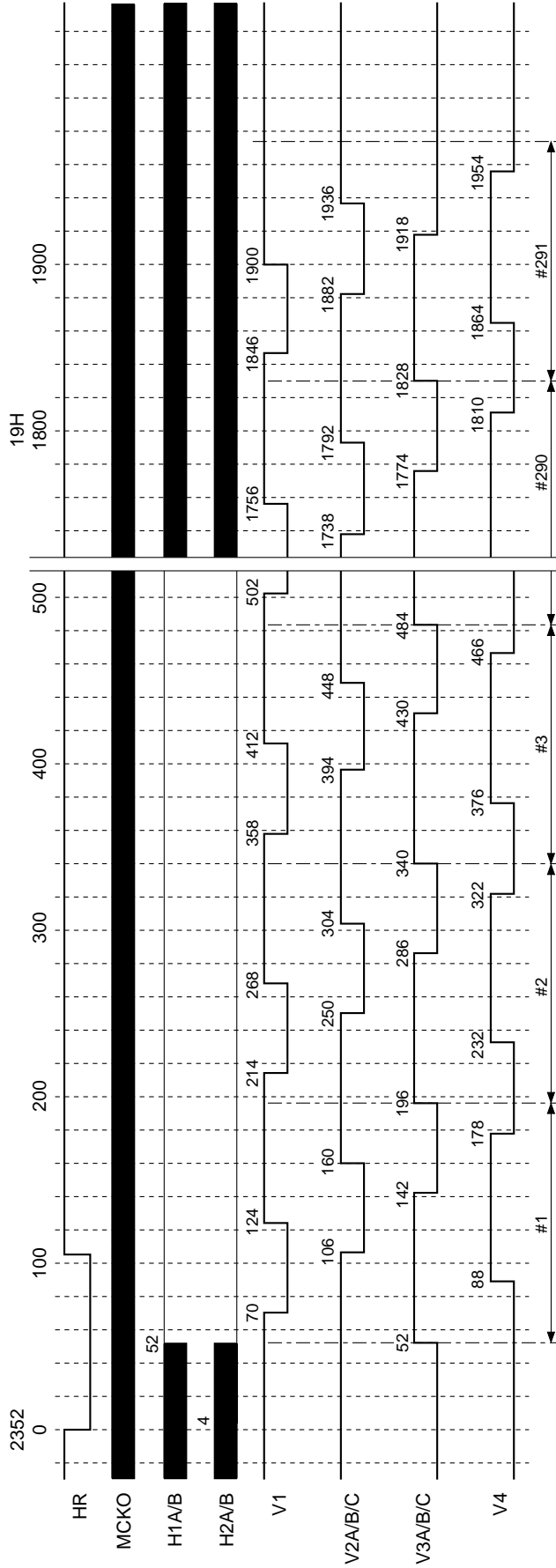

* The HR of this chart indicates the actual CXD3609R load timing.
 * The numbers at the output pulse transition points indicate the count at the MCKO rise from the fall of HR.
 * The HR fall period should be between approximately 5.0 to 28.7μs (when the drive frequency is 28MHz).
 This chart shows a period of 185ck (6.5μs). The internal SSG operates at this timing.

Chart-21.1 Horizontal Direction Timing Chart **MODE** **Applicable CCD image sensor**
 (B: frame shift) AF1 mode, 36MHz drive • ICX274

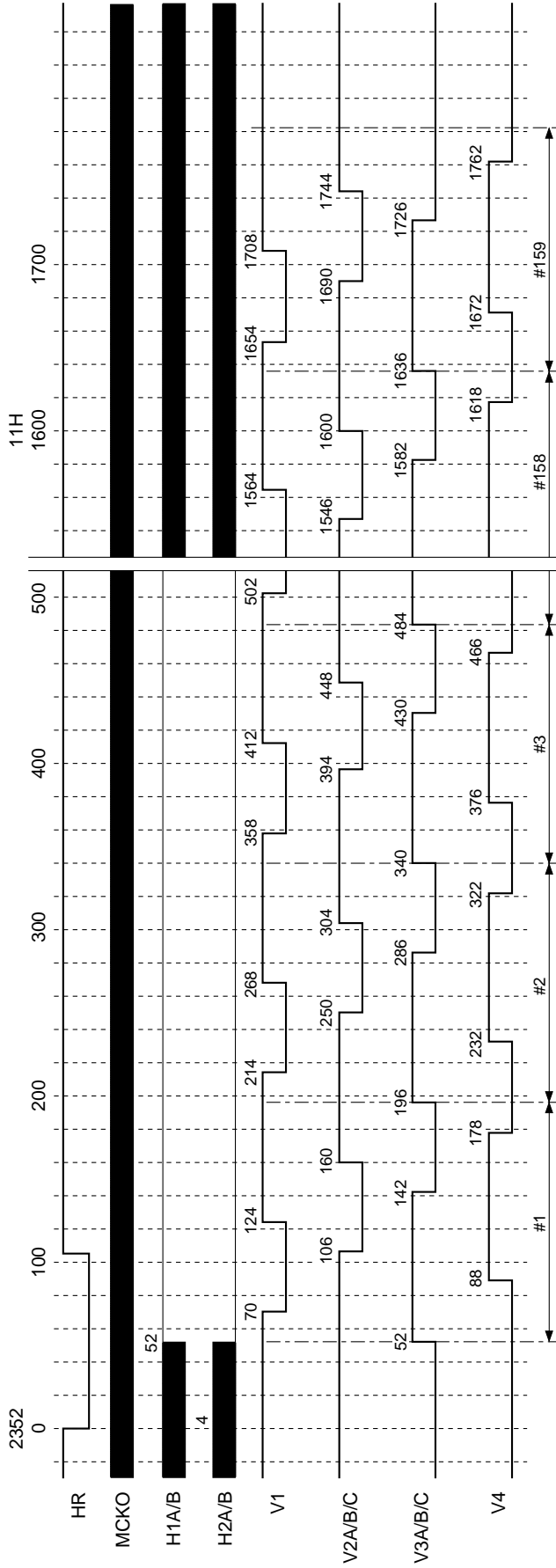

* The HR of this chart indicates the actual CXD3609R load timing.
 * The numbers at the output pulse transition points indicate the count at the MCKO rise from the fall of HR.
 * The HR fall period should be between approximately 5.0 to 28.7µs (when the drive frequency is 28MHz).
 This chart shows a period of 185clk (6.5µs). The internal SSG operates at this timing.

Chart-22 Horizontal Direction Timing Chart **MODE** **Applicable CCD image sensor**
(B: frame shift) **AF2 mode, 28MHz drive** **• ICX274**

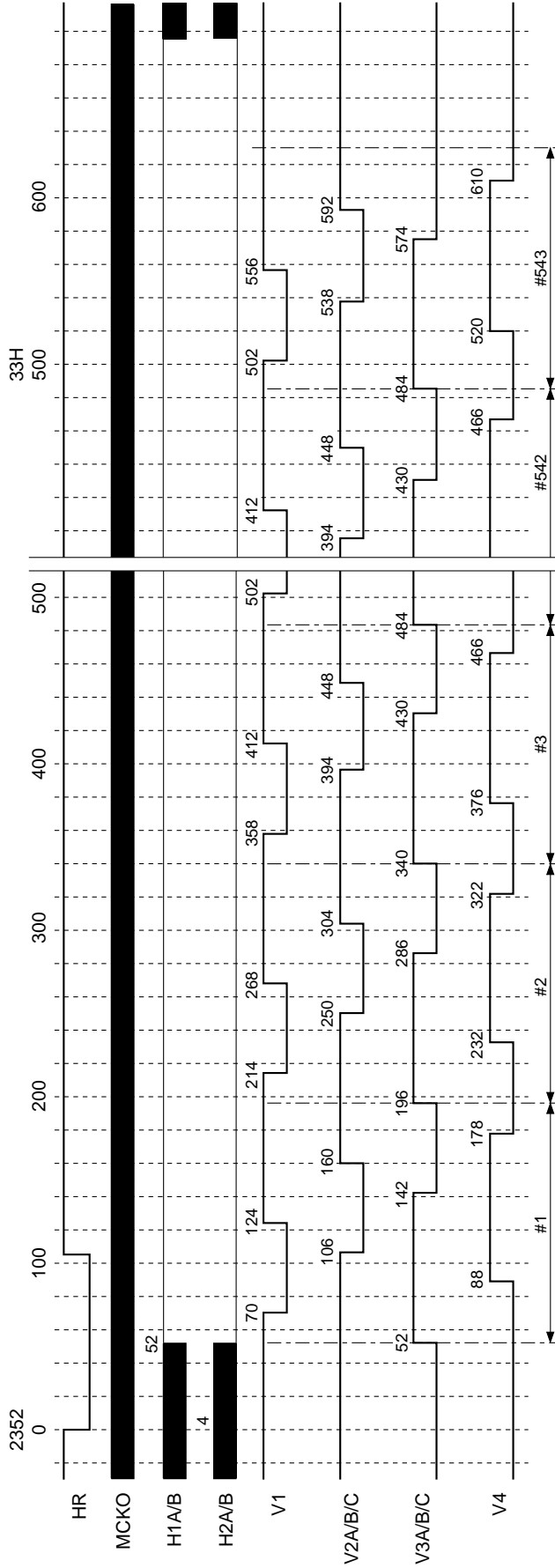

* The HR of this chart indicates the actual CXD3609R load timing.
 * The numbers at the output pulse transition points indicate the count at the MCKO rise from the fall of HR.
 * The HR fall period should be between approximately 5.0 to 28.7μs (when the drive frequency is 28MHz).
 This chart shows a period of 185clk (6.5μs). The internal SSG operates at this timing.

Chart-22.1 Horizontal Direction Timing Chart **MODE** **Applicable CCD image sensor**
 (B: frame shift) AF2 mode, 36MHz drive • ICX274

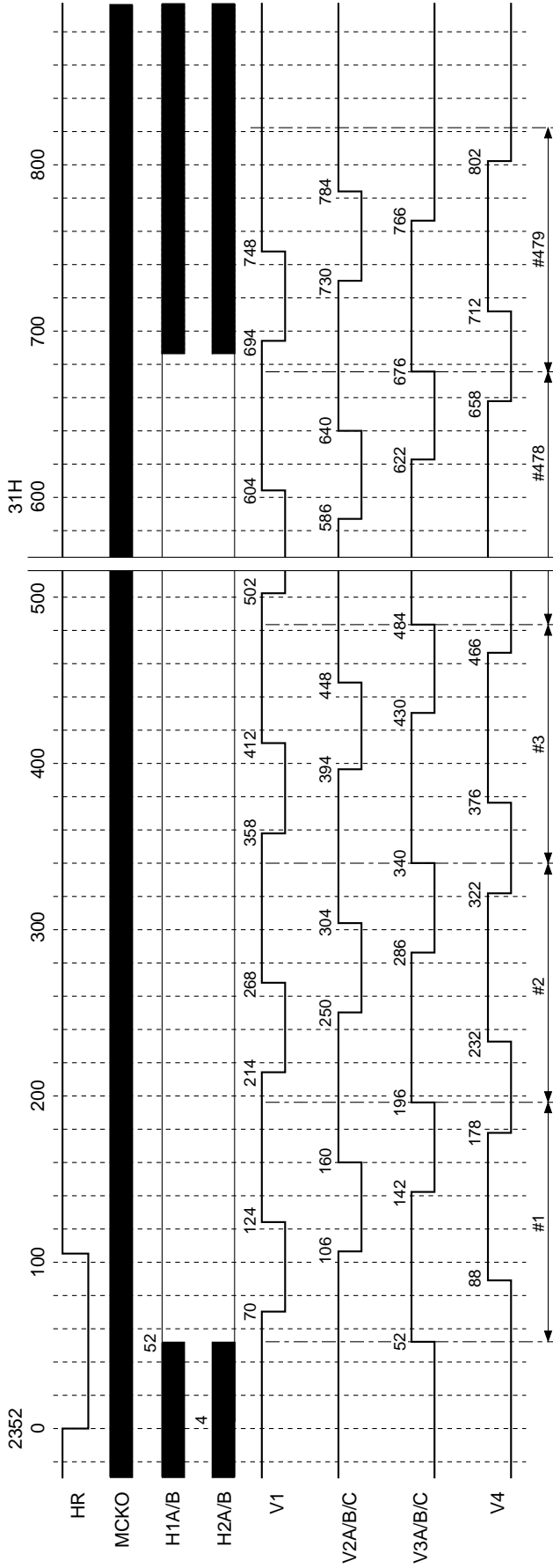

* The HR of this chart indicates the actual CXD3609R load timing.
 * The numbers at the output pulse transition points indicate the count at the MCKO rise from the fall of HR.
 * The HR fall period should be between approximately 5.0 to 28.7µs (when the drive frequency is 28MHz).
 This chart shows a period of 185ck (6.5µs). The internal SSG operates at this timing.

Chart-23 Horizontal Direction Timing Chart

(A: readout block) **MODE** Progressive scan mode – high-speed sweep not present – 28MHz (36MHz) drive

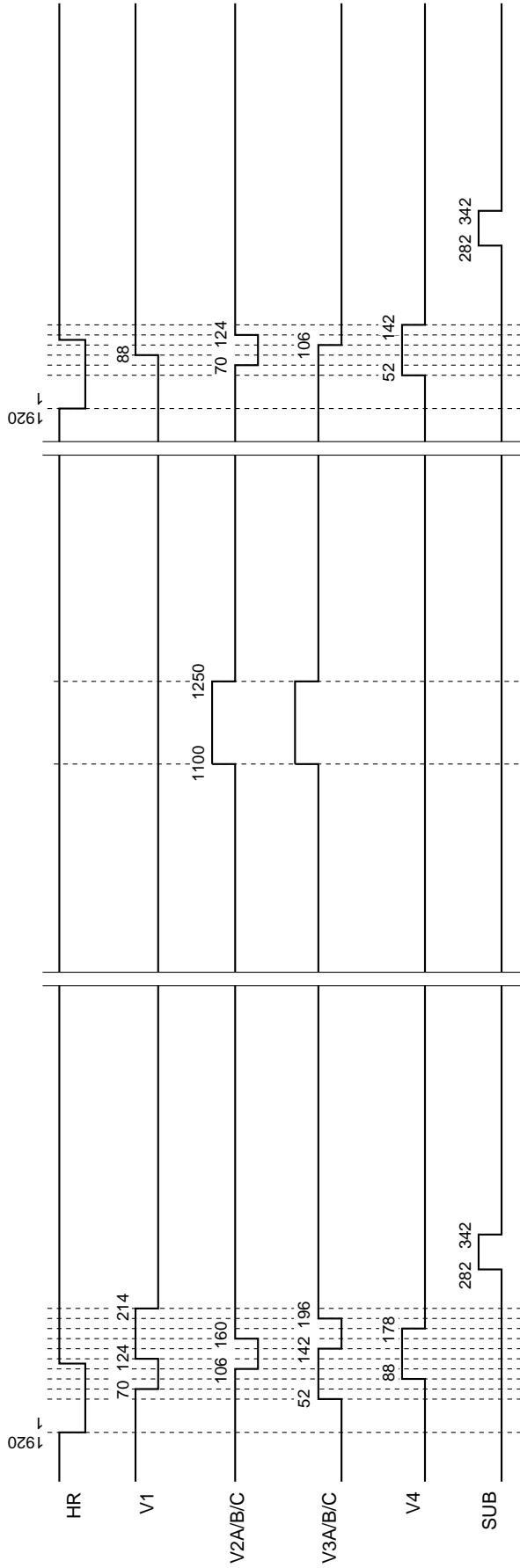

Applicable CCD image sensor
• ICX274

* The HR of this chart indicates the actual CXD3609R load timing.
* The numbers at the output pulse transition points indicate the count at the MCKO rise from the fall of HR.

Chart-24 Horizontal Direction Timing Chart (A: readout block) **MODE** Monitoring mode 28MHz (36MHz) drive **Applicable CCD image sensor**
 • ICX274

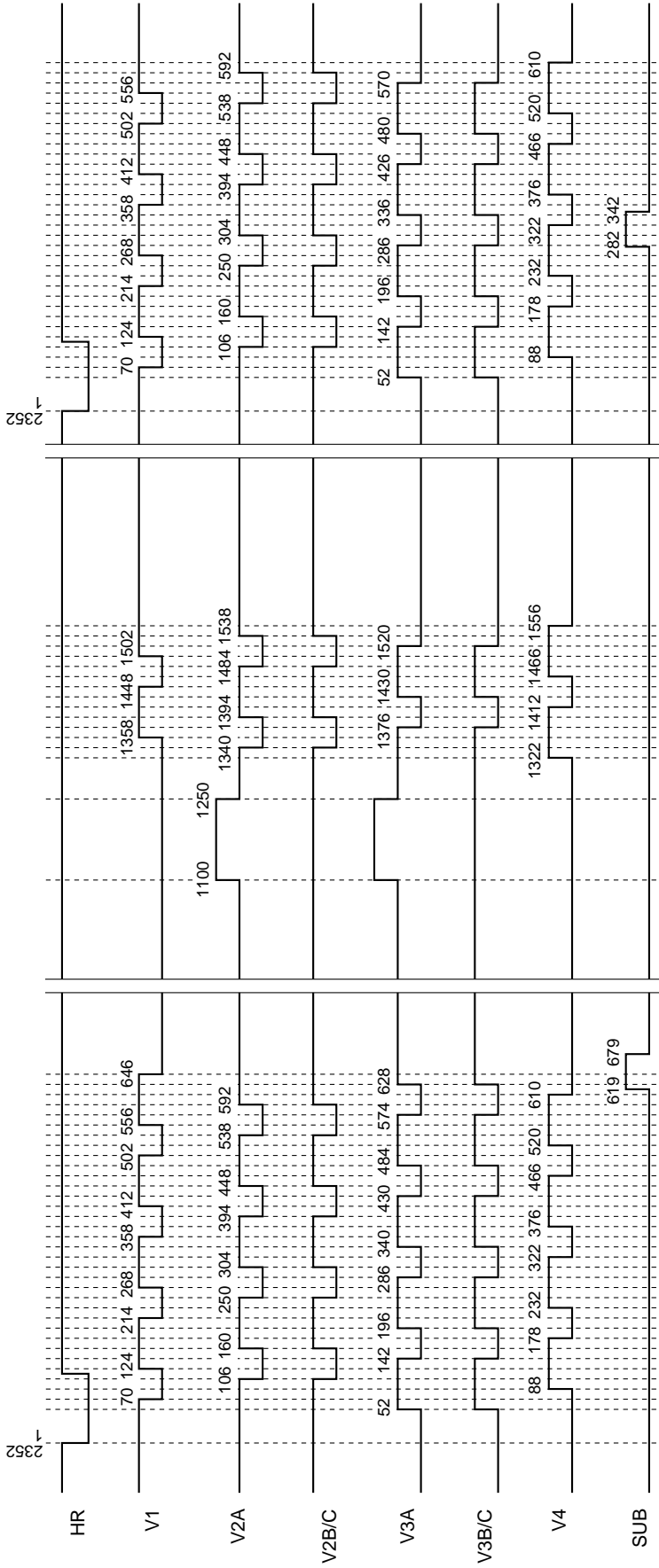

* The HR of this chart indicates the actual CXD3609R load timing.
 * The numbers at the output pulse transition points indicate the count at the MCKO rise from the fall of HR.

Chart-25 Horizontal Direction Timing Chart **MODE** **Applicable CCD image sensor**
 (A: readout block) **Draft mode 28MHz (36MHz) drive** • ICX274

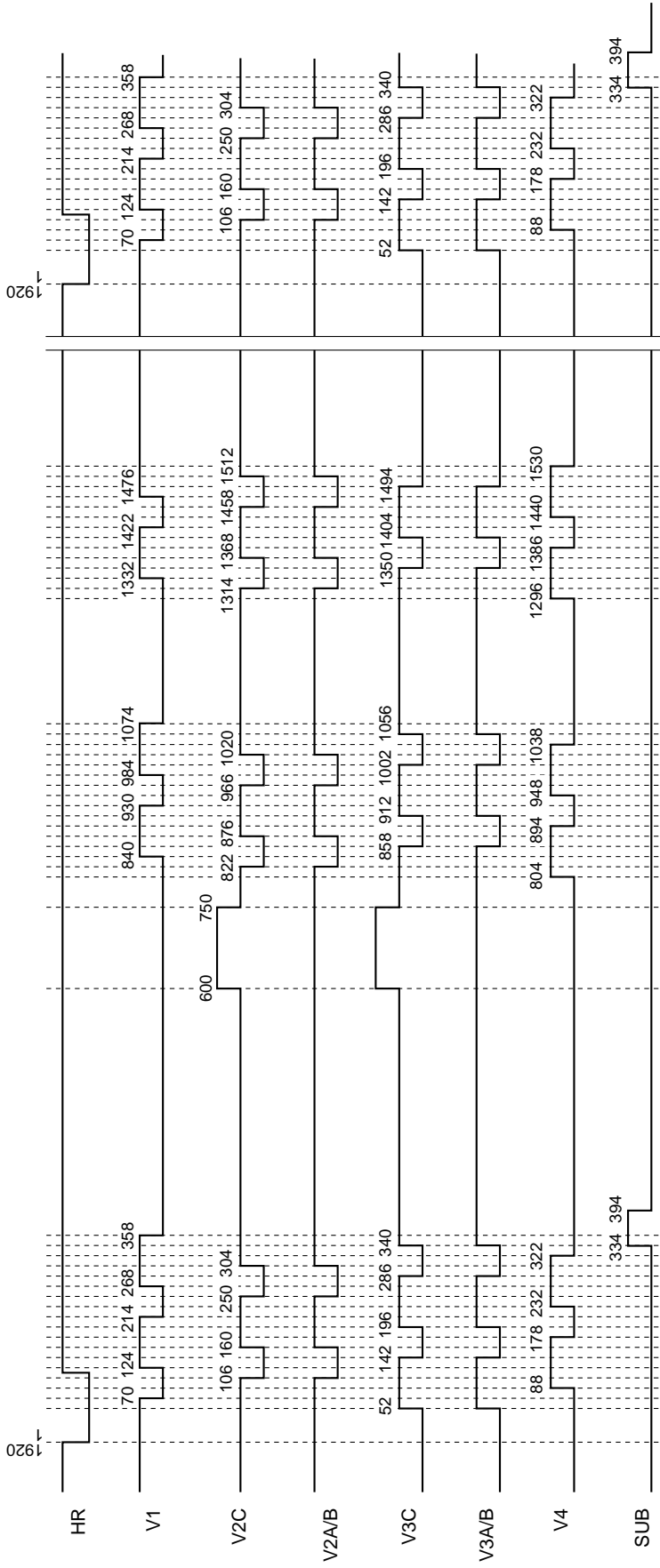

* The HR of this chart indicates the actual CXD3609R load timing.
 * The numbers at the output pulse transition points indicate the count at the MCKO rise from the fall of HR.

Chart-26 Horizontal Direction Timing Chart **MODE** **Applicable CCD image sensor**
(A: readout block) 2-line addition mode 28MHz (36MHz) drive • ICX274

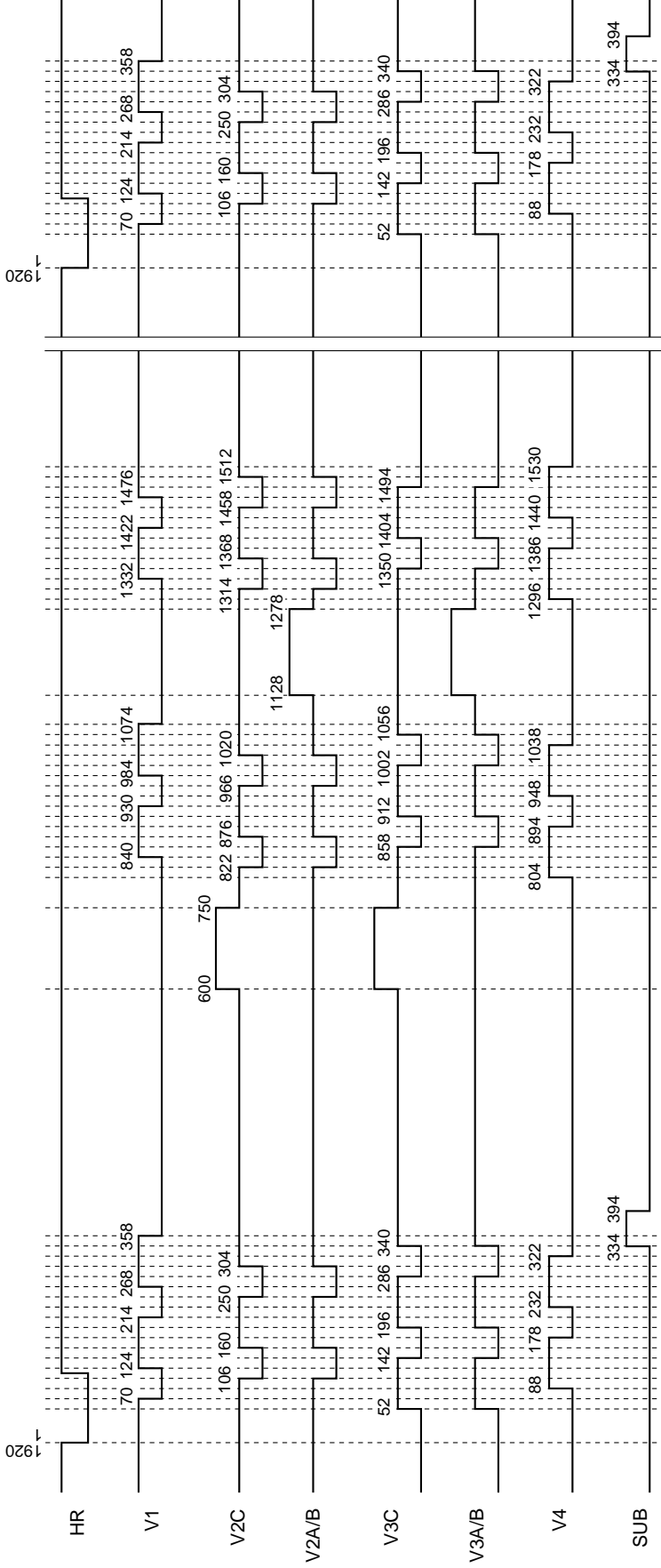

* The HR of this chart indicates the actual CXD3609R load timing.
 * The numbers at the output pulse transition points indicate the count at the MCKO rise from the fall of HR.

Chart-27 Horizontal Direction Timing Chart (A: readout block) **MODE** Center scan 1 mode 28MHz (36MHz) drive **Applicable CCD image sensor**
 • ICX274

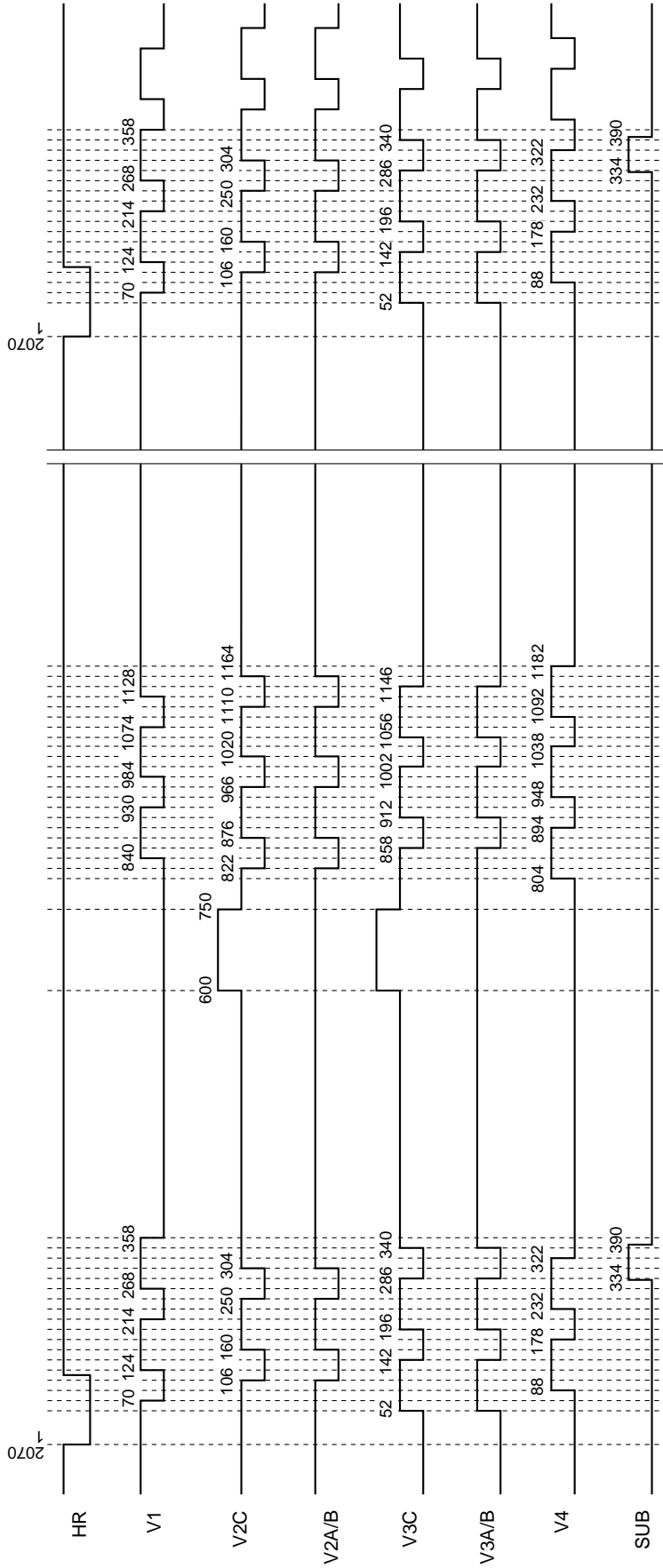

* The HR of this chart indicates the actual CXD3609R load timing.
 * The numbers at the output pulse transition points indicate the count at the MCKO rise from the fall of HR.

Chart-28 Horizontal Direction Timing Chart **MODE**
 (A: readout block) Center scan 2 mode 28MHz (36MHz) drive

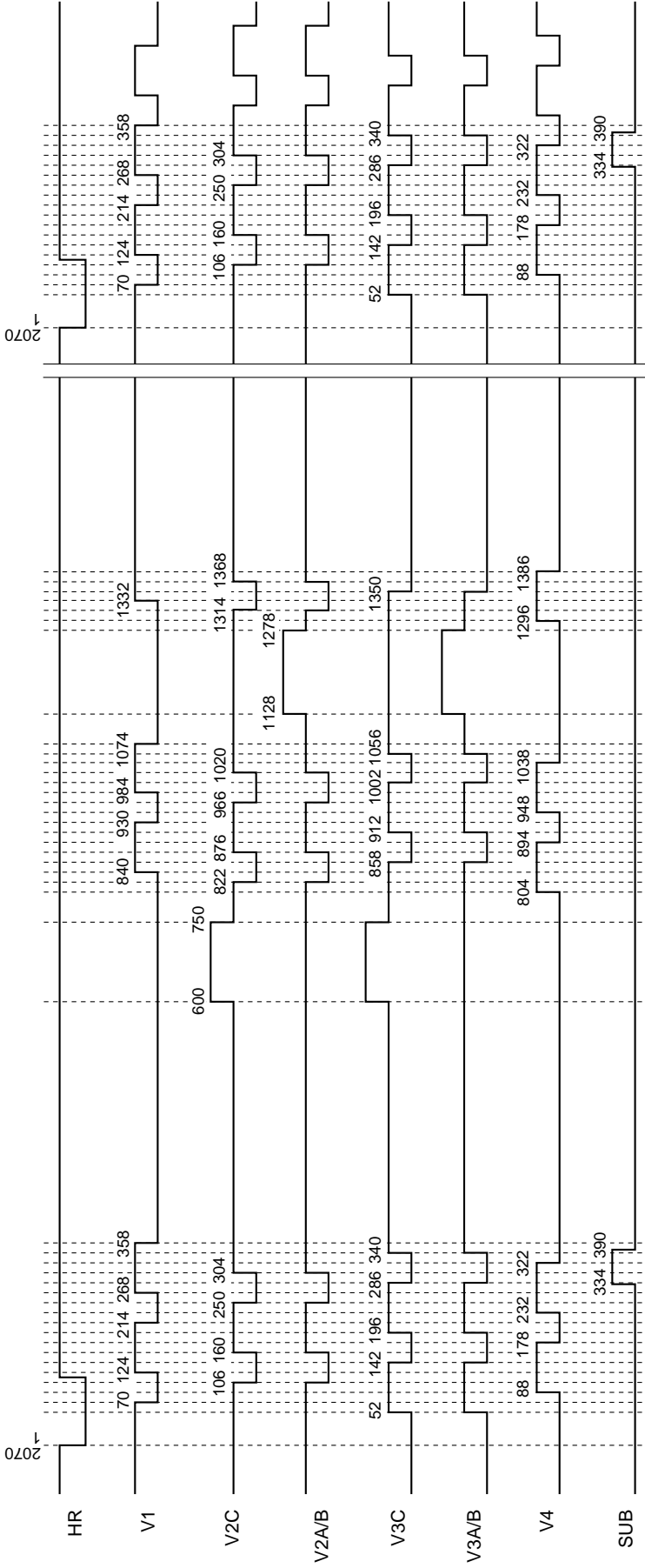

Applicable CCD image sensor
 • ICX274

* The HR of this chart indicates the actual CXD3609R load timing.
 * The numbers at the output pulse transition points indicate the count at the MCKO rise from the fall of HR.

Chart-29 Horizontal Direction Timing Chart **MODE** **Applicable CCD image sensor**
 (A: readout block) Center scan 3 mode 28MHz (36MHz) drive • ICX274

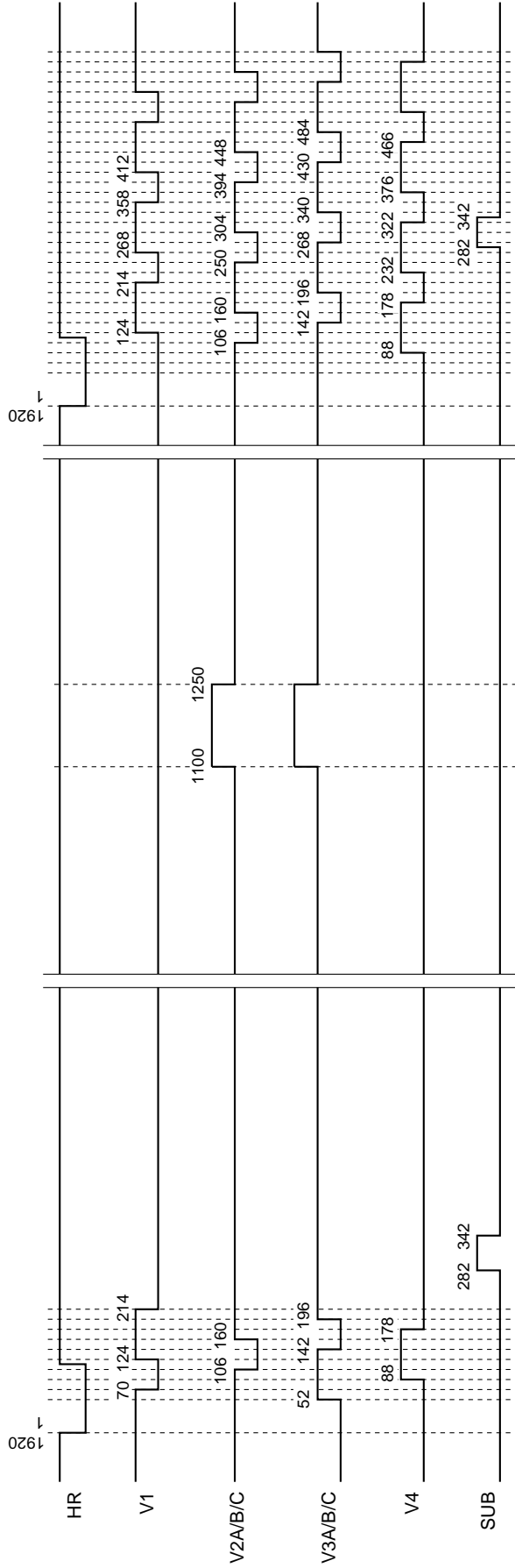

* The HR of this chart indicates the actual CXD3609R load timing.
 * The numbers at the output pulse transition points indicate the count at the MCKO rise from the fall of HR.

Chart-30 Horizontal Direction Timing Chart (A: readout block) **MODE AF1 and AF2 mode 28MHz (36MHz) drive** **Applicable CCD image sensor • ICX274**

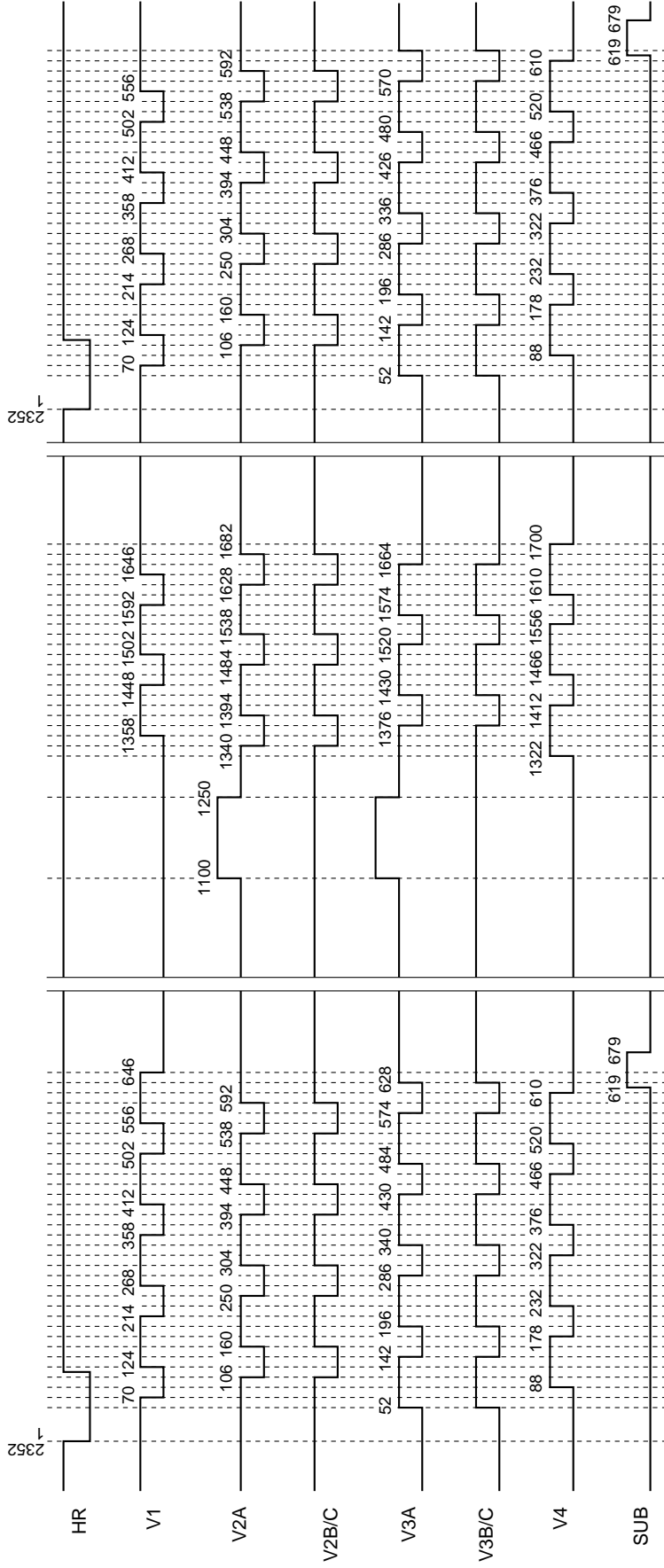

* The HR of this chart indicates the actual CXD3609R load timing.
 * The numbers at the output pulse transition points indicate the count at the MCKO rise from the fall of HR.

Applicable CCD image sensor
 • ICX274

MODE

Chart-31 High-Speed Phase Timing Chart

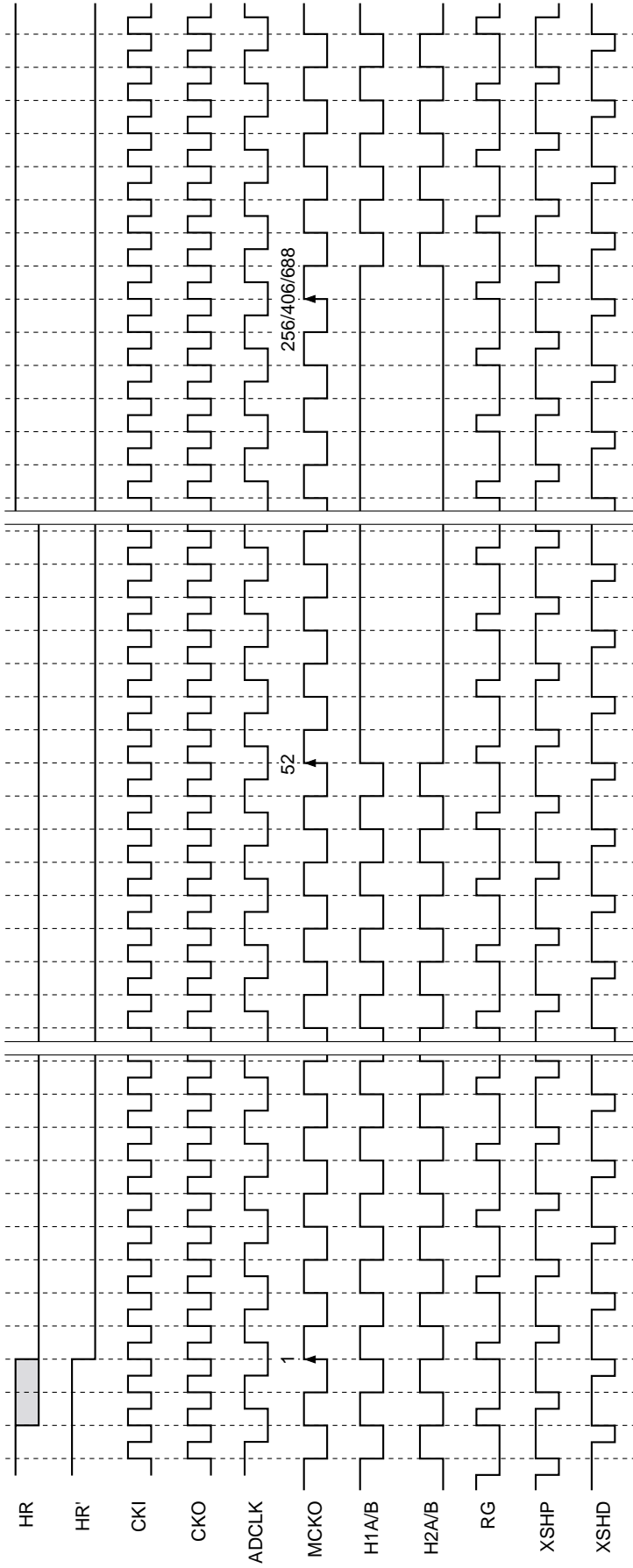

* HR' of this chart indicates the actual CXD3606R load timing.
 * The phase relationship of each pulse shows the logical position relationship. For the actual output waveform, a delay is added to each pulse.
 * The logic phase of ADCLK can be specified by the serial interface data.

Chart-32 Vertical Direction Sequence Chart **MODE**
Applicable CCD image sensor
 • ICX274

Progressive scan mode – high-speed sweep not present –
 28MHz (36MHz) drive
 → Trigger in mode → Trigger mode → Trigger out mode

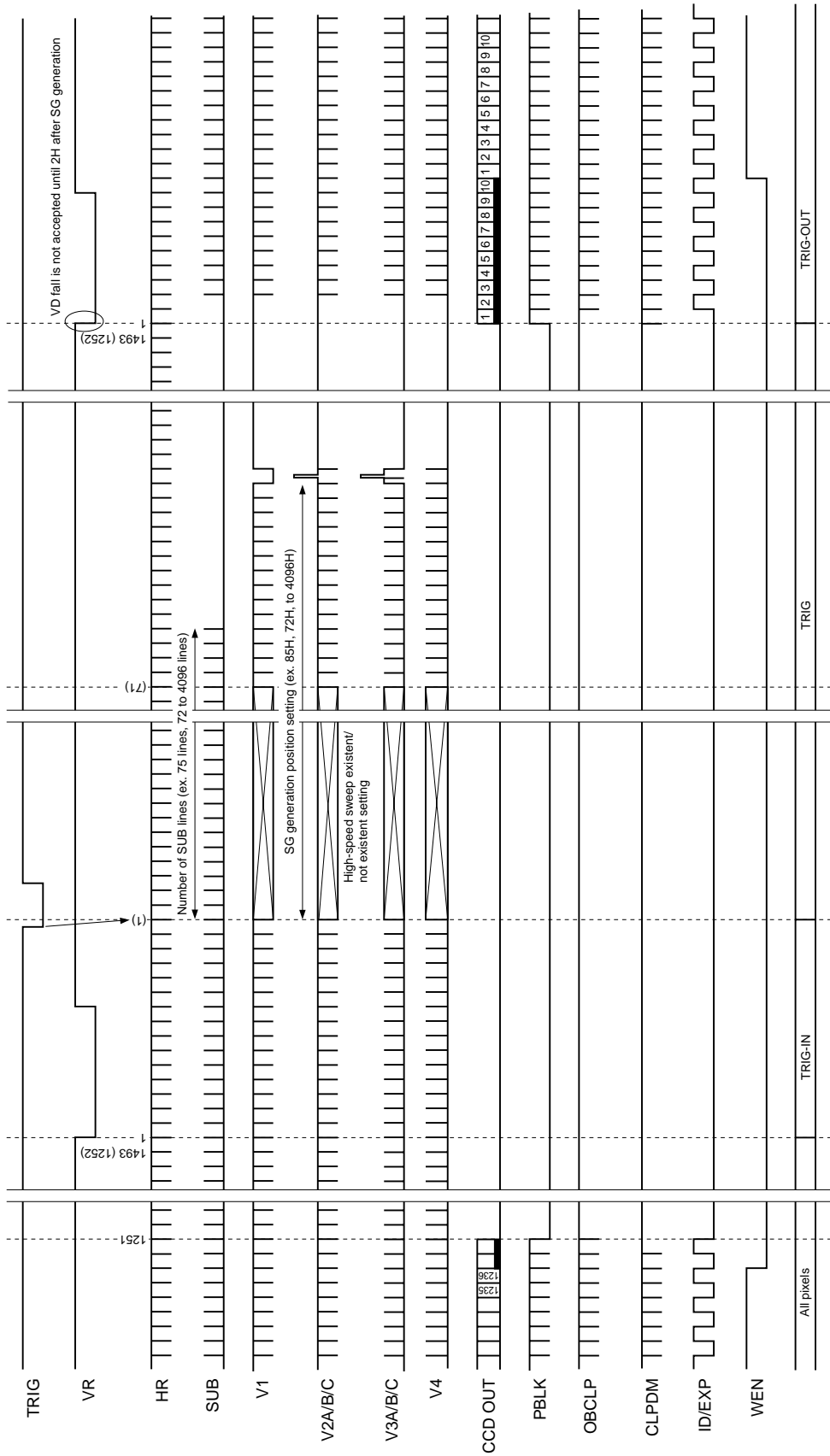

* The number of SUB pulses is determined by the serial interface data. This chart shows the case where SUB pulses are output in all horizontal periods.
 * ID/EXP of this chart shows ID. ID is low for lines where CCD OUT contains the R component, and high for lines where CCD OUT contains the B component.
 * During 28MHz drive, the VR period is 1493H, and at 1493H one horizontal period is 1860ck.
 * During 36MHz drive, the VR period is 1252H, and at 1252H one horizontal period is 1860ck.
 * The VD fall is not accepted until 2H after SG generation. For example, when SG is generated at 23H, VR is not accepted from 1H to 24H, but is accepted from 25H onward.
 * Even when SG generation position > number of SUB pulses in the serial data, SG generation position = number of SUB pulses is used.

Application Circuit Block diagram

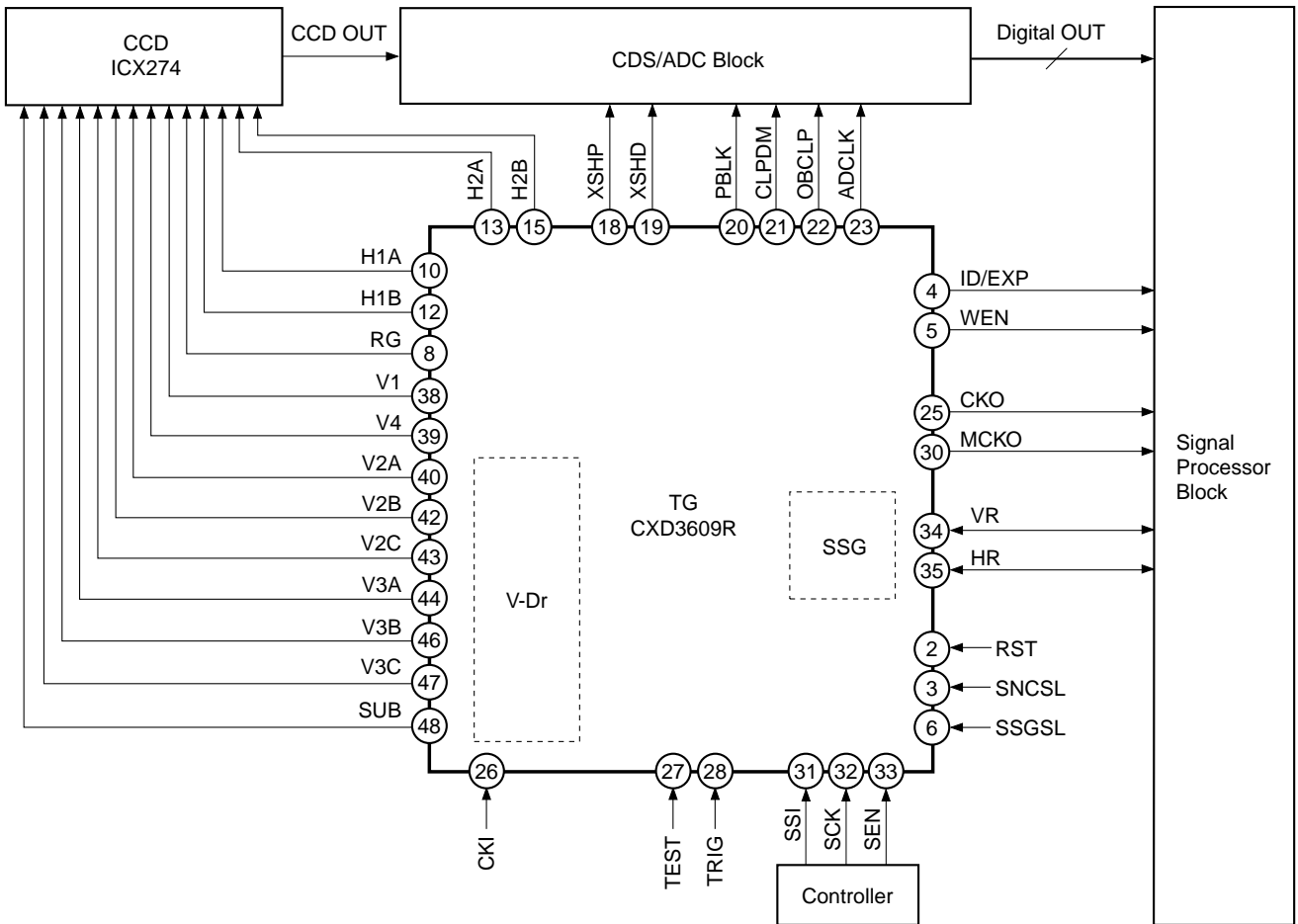

Application circuits shown are typical examples illustrating the operation of the devices. Sony cannot assume responsibility for any problems arising out of the use of these circuits or for any infringement of third party patent and other right due to same.

Notes for Power-on

Of the three -7.5V, +15.0V, +3.3V power supplies, be sure to start up the -7.5V and +15.0V power supplies in the following order to prevent the SUB pin of the CCD image sensor from going to negative potential.

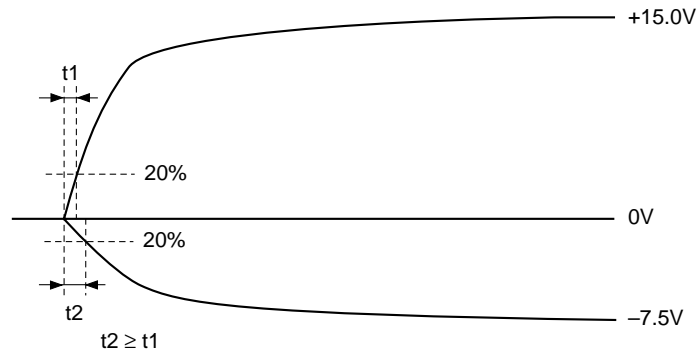

Package Outline

Unit: mm

48PIN LQFP (PLASTIC)

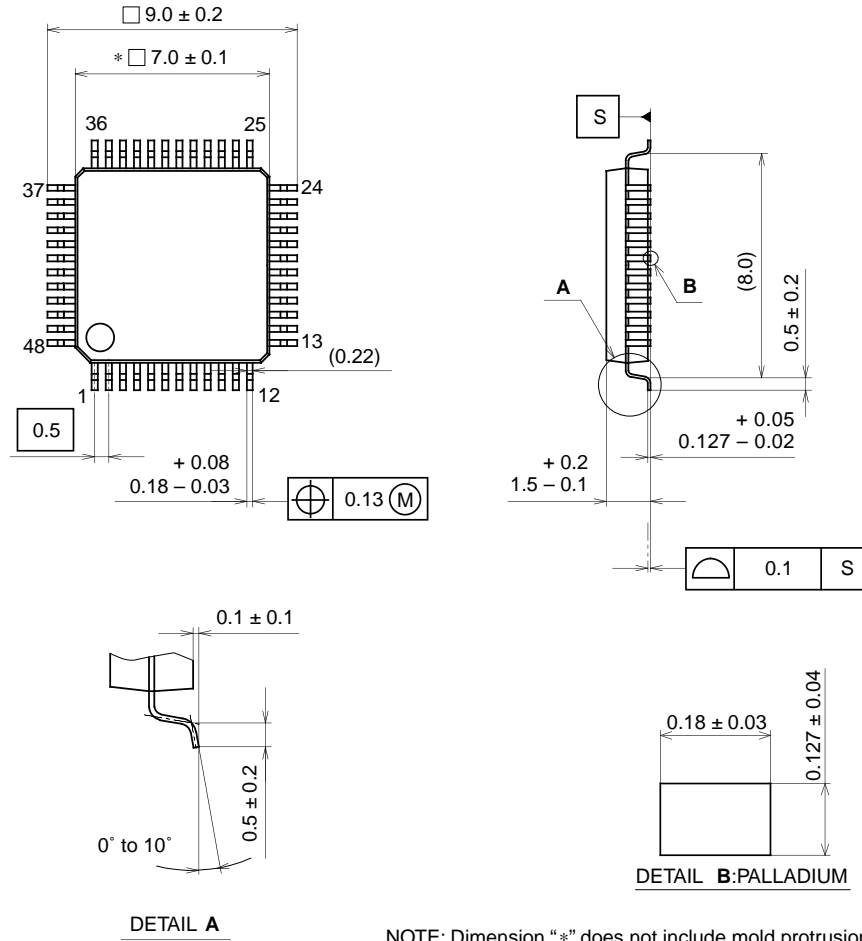

NOTE: Dimension "*" does not include mold protrusion.

PACKAGE STRUCTURE

SONY CODE	LQFP-48P-L01
EIAJ CODE	LQFP048-P-0707
JEDEC CODE	_____

PACKAGE MATERIAL	EPOXY RESIN
LEAD TREATMENT	PALLADIUM PLATING
LEAD MATERIAL	COPPER ALLOY
PACKAGE MASS	0.2g