

SONY**CXK54256P** 35/45/55**65,536-word × 4-bit High Speed CMOS Static RAM****Description**

CXK54256P is a 262,144 bits high speed CMOS static RAM organized as 65,536 words by 4 bits and operates from a single 5V supply.

This device is suitable for use in high speed and low power applications.

Features

- Fast access time (Access time)
CXK54256P-35 35ns (Max.)
CXK54256P-45 45ns (Max.)
CXK54256P-55 55ns (Max.)
- Low power consumption (operation) :100mW (Typ.)
- Single + 5V supply :5V ± 10 %
- Fully static memory...No clock or timing strobe required.
- Equal access and cycle time.
- Common data input and output : three-state output
- Directly TTL compatible : All inputs and outputs.
- High density : 300 mil 24 pin plastic package

24 pin DIP (Plastic)

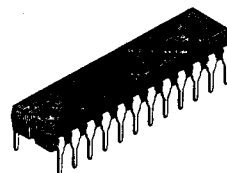
**Structure**

Silicon gate CMOS IC

Function

65,536-word × 4-bit static RAM

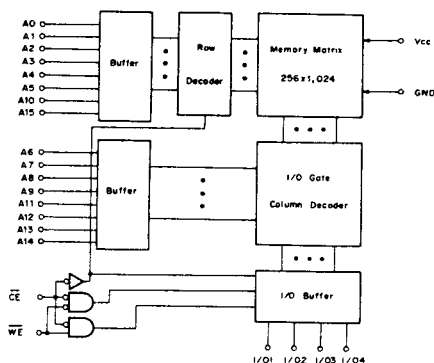
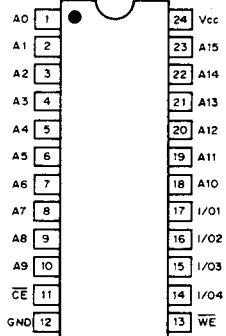
Block Diagram**Pin Configuration (Top View)****Pin Description**

Symbol	Description
A0 to A15	Address input
I/O1 to I/O4	Data input output
\overline{CE}	Chip enable input
\overline{WE}	Write enable input
Vcc	+ 5V power supply
GND	Ground

Absolute Maximum Ratings

(Ta = 25°C, GND = 0V)

Item	Symbol	Rating	Unit
Supply voltage	V _{CC}	- 0.5* to + 7.0	V
Input voltage	V _{IN}	- 0.5* to V _{CC} + 0.5	V
Input and output voltage	V _{I/O}	- 0.5* to V _{CC} + 0.5	V
Allowable power dissipation	P _D	1.0	W
Operating temperature	T _{opr}	0 to + 70	°C
Storage temperature	T _{stg}	- 55 to + 150	°C
Soldering temperature • time	T _{solder}	260 • 10	°C • sec

*Note) V_{CC}, V_{IN}, V_{I/O} = - 3.5V Min. for pulse width less than 20ns.

Truth Table

CE	WE	Mode	I/O1 to I/O4	V _{CC} Current
H	X	Not selected	High Z	I _{SB1} , I _{SB2}
L	H	Read	Data out	I _{CC1} , I _{CC2}
L	L	Write	Data in	I _{CC1} , I _{CC2}

X: "H" or "L"

DC Recommended Operating Conditions

(Ta = 0 to + 70°C, GND = 0V)

Item	Symbol	Min.	Typ.	Max.	Unit
Supply voltage	V _{CC}	4.5	5.0	5.5	V
Input high voltage	V _{IH}	2.2	—	V _{CC} + 0.3	V
Input low voltage	V _{IL}	- 0.3*	—	0.8	V

*Note) V_{IL} = - 3.0V Min. for pulse width less than 20ns.

Electrical Characteristics

●DC and operating characteristics ($V_{CC} = 5V \pm 10\%$, $GND = 0V$, $T_a = 0$ to $+70^\circ C$)

Item	Symbol	Test condition	- 35/45/55			Unit
			Min.	Typ.*	Max.	
Input leak current	I_{LI}	$V_{IN} = GND$ to V_{CC} $V_{CC} = 5.5V$	-1	—	1	μA
Output leak current	I_{LO}	$\overline{CE} = V_{IH}$ $V_{I/O} = GND$ to V_{CC}	-1	—	1	μA
Operating power supply current	I_{CC1}	$\overline{CE} = V_{IL}$, $I_{OUT} = 0mA$ $V_{IN} = V_{IH}/V_{IL}$	—	20	45	mA
Average operating current	I_{CC2}	Cycle = Min, Duty = 100% $I_{OUT} = 0mA$	—	55	85	mA
Standby current	I_{SB1}	$\overline{CE} \geq V_{CC} - 0.2V$, $V_{IN} \geq V_{CC} - 0.2V$ or $V_{IN} \leq 0.2V$	—	—	2	mA
	I_{SB2}	$\overline{CE} = V_{IH}$	—	15	30	mA
Output high voltage	V_{OH}	$I_{OH} = -4.0mA$	2.4	—	—	V
Output low voltage	V_{OL}	$I_{OL} = 8.0mA$	—	—	0.4	V

* $V_{CC} = 5V$, $T_a = 25^\circ C$

I/O capacitance

($T_a = 25^\circ C$, $f = 1MHz$)

Item	Symbol	Test condition	Min.	Max.	Unit
Input capacitance	C_{IN}	$V_{IN} = 0V$	—	7	pF
Input/Output capacitance	$C_{I/O}$	$V_{I/O} = 0V$	—	7	pF

Note) This parameter is sampled and is not 100% tested.

AC characteristics

●AC test conditions

($V_{CC} = 5V \pm 10\%$, $T_a = 0$ to $+70^\circ C$)

Item	Condition
Input pulse high level	$V_{IH} = 3.0V$
Input pulse low level	$V_{IL} = 0V$
Input rise time	$t_r = 5ns$
Input fall time	$t_f = 5ns$
Input and output reference level	1.5V
Output load conditions	Fig. 1

Output Load (1)

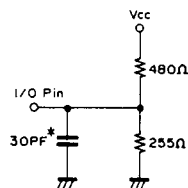

Output Load (2)**

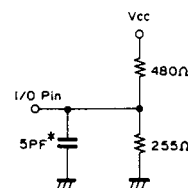

* including scope and jig
** for t_{LZ} , t_{HZ} , t_{OW} , t_{WHZ}

Fig. 1

● Read cycle

Item	Symbol	- 35		- 45		- 55		Unit
		Min.	Max.	Min.	Max.	Min.	Max.	
Read cycle time	t _{RC}	35	—	45	—	55	—	ns
Address access time	t _{AA}	—	35	—	45	—	55	ns
Chip enable access time (CE)	t _{CO}	—	35	—	45	—	55	ns
Output hold from address change	t _{OH}	5	—	5	—	5	—	ns
Chip enable to output in low Z (\overline{CE})	t _{LZ} *	5	—	5	—	5	—	ns
Chip disable to output in high Z	t _{HZ} *	0	15	0	15	0	20	ns
Chip enable to power up time	t _{PU}	0	—	0	—	0	—	ns
Chip disable to power down time	t _{PD}	—	30	—	30	—	30	ns

*Note) Transition is measured $\pm 200\text{mV}$ from steady voltage with specified loading in Fig. 1.
This parameter is sampled and is not 100% tested.

● Write cycle

Item	Symbol	- 35		- 45		- 55		Unit
		Min.	Max.	Min.	Max.	Min.	Max.	
Write cycle time	t _{WC}	35	—	45	—	55	—	ns
Address valid to end of write	t _{AW}	30	—	35	—	45	—	ns
Chip enable to end of write	t _{CW}	30	—	35	—	45	—	ns
Data to write time overlap	t _{DW}	15	—	20	—	25	—	ns
Data hold from write time	t _{DH}	0	—	0	—	0	—	ns
Write pulse width	t _{WP}	30	—	35	—	45	—	ns
Address set up time	t _{AS}	0	—	0	—	0	—	ns
Write recovery time	t _{WR}	0	—	0	—	0	—	ns
Output active from end of write	t _{OW} *	5	—	5	—	5	—	ns
Write to output in high Z	t _{WHZ} *	0	15	0	15	0	20	ns

*Note) Transition is measured $\pm 200\text{mV}$ from steady voltage with specified loading in Fig. 1.
This parameter is sampled and is not 100% tested.

Timing Waveform

- Read cycle (1) : $\overline{WE} = V_{IH}$

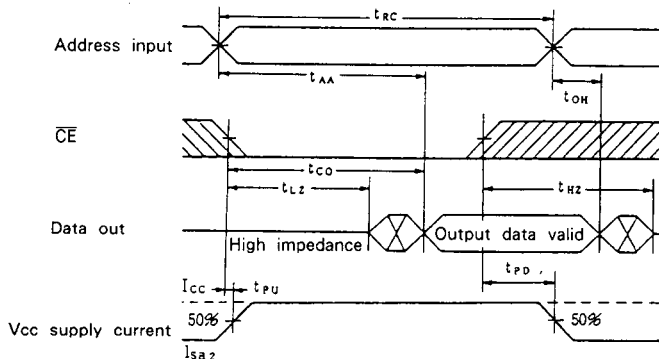

- Write cycle (1) : \overline{WE} control

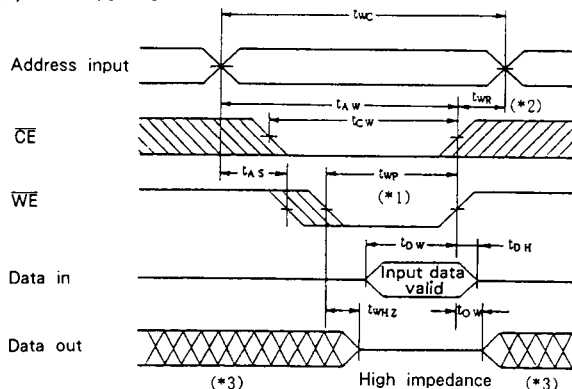

- Write cycle (2) : \overline{CE} control

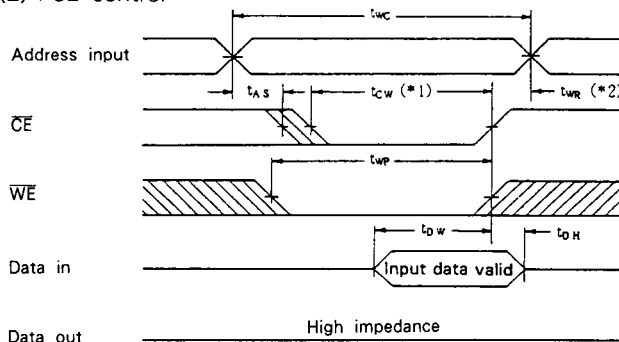

* Note)

1. A write occurs during the low overlap of \overline{CE} and \overline{WE} .
2. t_{WR} is measured from the earlier of \overline{CE} or \overline{WE} going high to the end of write cycle.
3. During this period, I/O pins are in the output state so that the input signals of opposite phase to the output must not be applied.

Example of Representative Characteristics

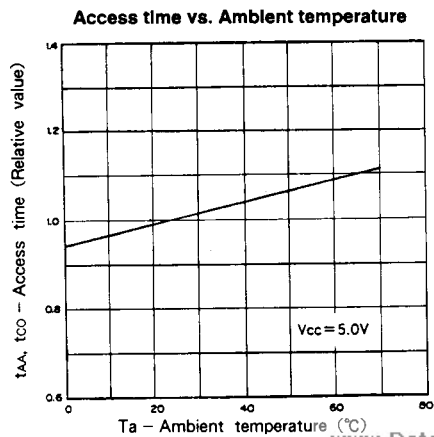
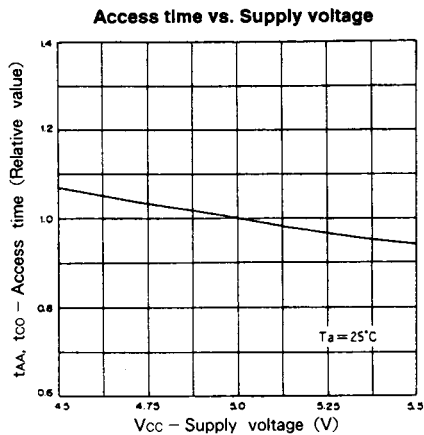
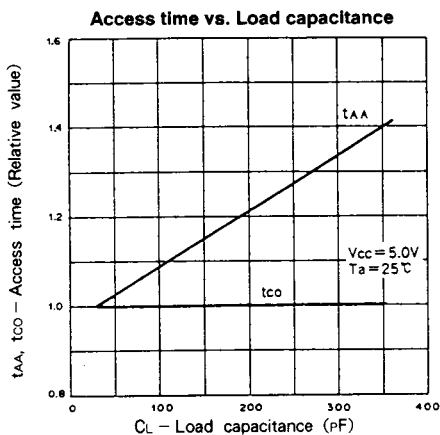
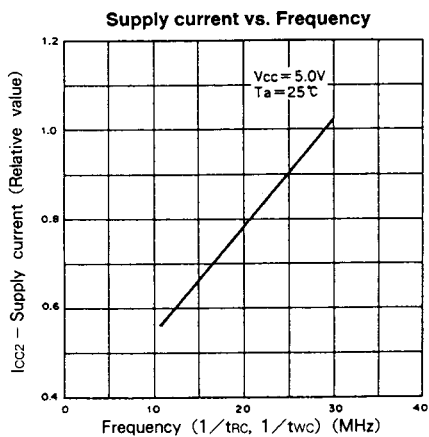
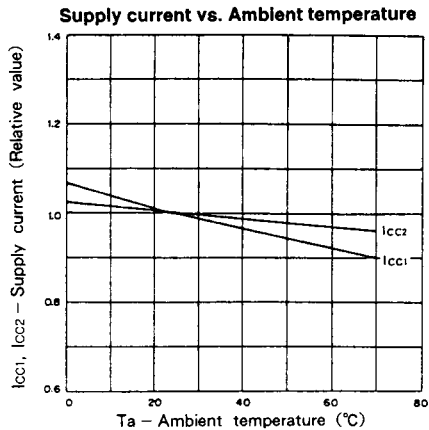
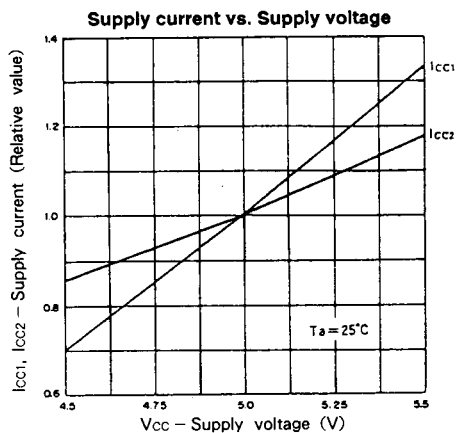

Standby current vs. Supply voltage

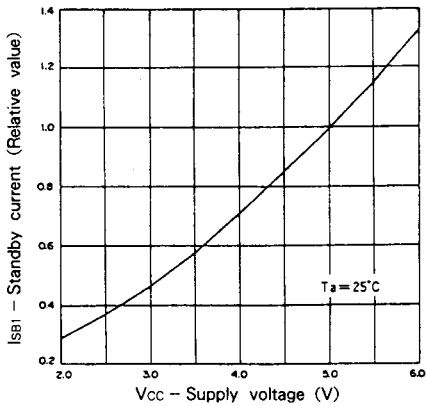

Standby current vs. Ambient temperature

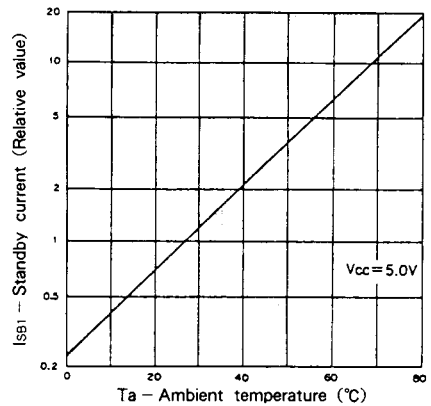

Input voltage level vs. Supply voltage

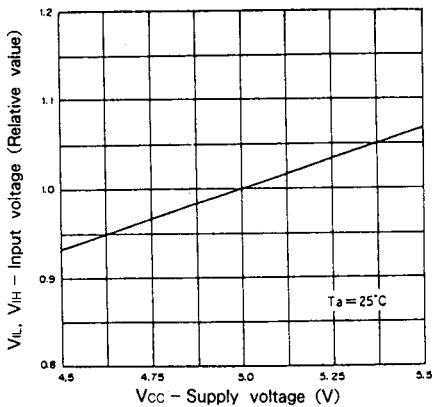

Standby current vs. Ambient temperature

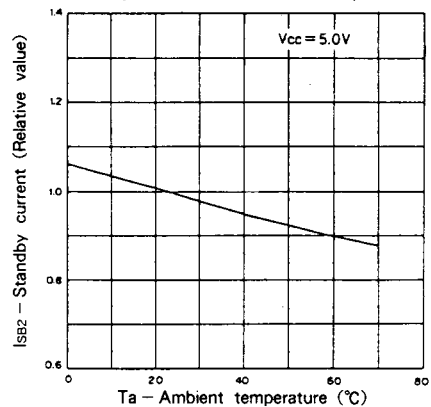

Output high current vs. Output high voltage

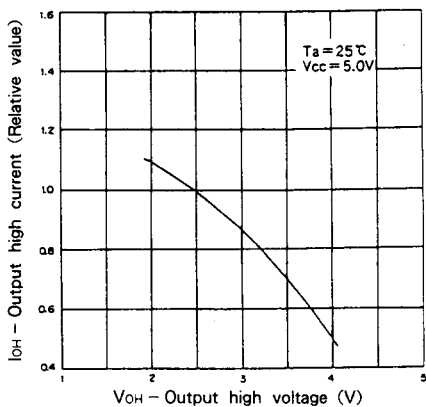

Output low current vs. Output low voltage

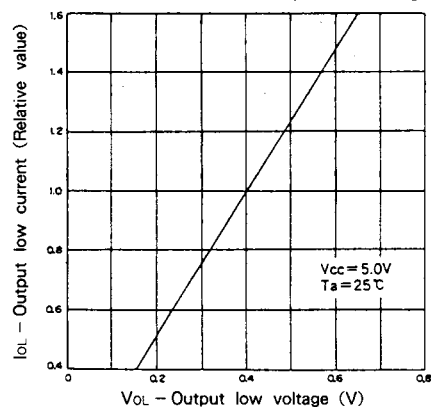

Package Outline Unit : mm

CXK54256P 24 pin DIP (Plastic) 300mil 1.5g

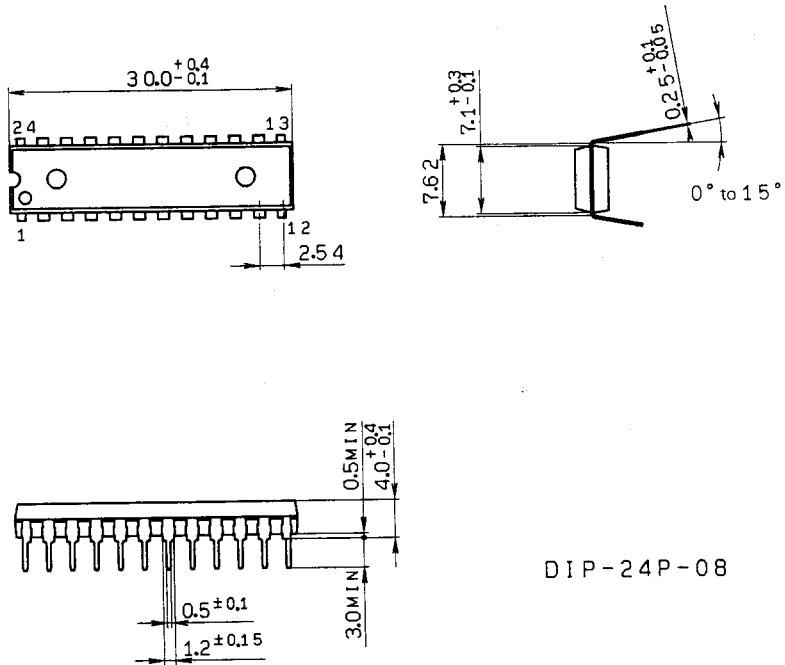

DIP-24P-08