

Three-PLL General Purpose EPROM Programmable Clock Generator

Features

- Three integrated phase-locked loops
- EPROM programmability
- Factory-programmable (CY2291) or field-programmable (CY2291F) device options
- Low-skew, low-jitter, high-accuracy outputs
- Power-management options (Shutdown, OE, Suspend)
- Frequency select option
- Smooth slewing on CPUCLK
- Configurable 3.3 V or 5 V operation
- 20-pin SOIC Package

Functional Description

The CY2291 is a third-generation family of clock generators. The CY2291 is upwardly compatible with the industry standard ICD2023 and ICD2028 and continues their tradition by providing a high level of customizable features to meet the diverse clock synchronous systems.

All parts provide a highly configurable set of close for PC motherboard applications. Each of four configurable clock outputs (CLKA-CLKD) can be assigned 1 of 30 frequencies in any combination. Multiple outputs configured for the same or related[3] frequencies have low (<500 ps) skew, in effect providing on-chip buffering for heavily loaded signals.

The CY2291 can be configured for either 5 V or 3.3 V operation. The internal ROM tables use EPROM technology, allowing full customization of output frequencies. The reference oscillator has been designed for 10 MHz to 25 MHz crystals, providing additional flexibility. No external components are required with this crystal. Alternatively, an external reference clock of frequency between 1 MHz to 30 MHz can be used. Customers using the 32 kHz oscillator must connect a 10-MW resistor in parallel with the 32 kHz crystal.

Part Number	Outputs	Input Frequency Range	Output Frequency Range	Specifics
CY2291	8	10 MHz – 25 MHz (external crystal) 1 MHz – 30 MHz (reference clock)	76.923 kHz – 100 MHz (5 V) 76.923 kHz – 80 MHz (3.3 V)	Factory programmable Commercial temperature
CY2291I	8	10 MHz – 25 MHz (external crystal) 1 MHz – 30 MHz (reference clock)	76.923 kHz – 90 MHz (5 V) 76.923 kHz – 66.6 MHz (3.3 V)	Factory programmable Industrial temperature
CY2291F	8	10 MHz – 25 MHz (external crystal) 1 MHz – 30 MHz (reference clock)	76.923 kHz – 90 MHz (5 V) 76.923 kHz – 66.6 MHz (3.3 V)	Field programmable Commercial temperature
CY2291FI	8	10 MHz – 25 MHz (external crystal) 1 MHz – 30 MHz (reference clock)	76.923 kHz – 80 MHz (5 V) 76.923 kHz – 60.0 MHz (3.3 V)	Field programmable Industrial temperature

Logic Block Diagram

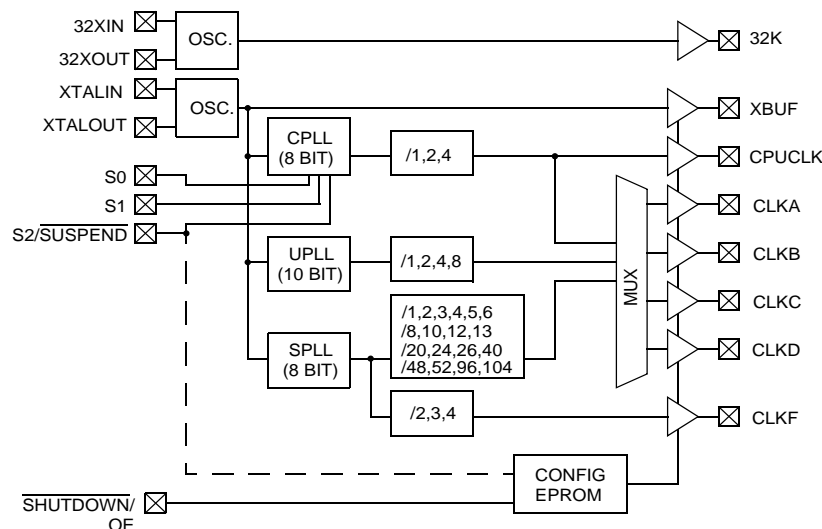

Contents

Pinouts	3	Switching Characteristics, Industrial 3.3 V	10
Pin Definitions	3	Switching Waveforms	11
Output Configuration	4	Test Circuit	11
Power Saving Features	4	Ordering Information	12
CyClocks Software	4	Possible Configurations	12
Cypress FTG Programmer	4	Ordering Code Definitions	12
Custom Configuration Request Procedure	4	Package Characteristics	12
Maximum Ratings	5	Package Diagram	13
Operating Conditions	5	Acronyms	14
Electrical Characteristics, Commercial 5.0 V	5	Document Conventions	14
Electrical Characteristics, Commercial 3.3 V	6	Units of Measure	14
Electrical Characteristics, Industrial 5.0 V	6	Document History Page	15
Electrical Characteristics, Industrial 3.3 V	7	Sales, Solutions, and Legal Information	16
Switching Characteristics, Commercial 5.0 V	7	Worldwide Sales and Design Support	16
Switching Characteristics, Commercial 3.3 V	8	Products	16
Switching Characteristics, Industrial 5.0 V	9	PSoC Solutions	16

Pinouts

Figure 1. CY2291- 20-pin SOIC

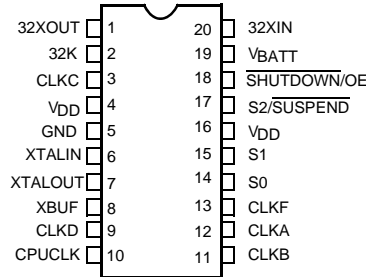

Pin Definitions

Name	Pin Number	Description
32XOUT ^[4]	1	32.768-kHz crystal feedback.
32K	2	32.768-kHz output (always active if VBATT is present).
CLKC	3	Configurable clock output C.
VDD	4, 16	Voltage supply.
GND	5	Ground.
XTALIN ^[1]	6	Reference crystal input or external reference clock input.
XTALOUT ^[1, 2]	7	Reference crystal feedback.
XBUF	8	Buffered reference clock output.
CLKD	9	Configurable clock output D.
CPUCLK	10	CPU frequency clock output.
CLKB	11	Configurable clock output B.
CLKA	12	Configurable clock output A.
CLKF	13	Configurable clock output F.
S0	14	CPU clock select input, bit 0.
S1	15	CPU clock select input, bit 1.
S2/SUSPEND	17	CPU clock select input, bit 2. Optionally enables suspend feature when LOW.
SHUTDOWN/OE	18	Places outputs in three-state ^[3] condition and shuts down chip when LOW. Optionally, only places outputs in three-state ^[3] condition and does not shut down chip when LOW.
VBATT ^[4]	19	Battery supply for 32.768-kHz circuit.
32XIN ^[4]	20	32.768 kHz crystal input.

Notes

1. For best accuracy, use a parallel-resonant crystal, C_{LOAD} ≈ 17 pF or 18 pF.
2. Float XTALOUT pin if XTALIN is driven by reference clock (as opposed to crystal).
3. The CY2291 has weak pull downs on all outputs (except 32K). Hence, when a three-state condition is forced on the outputs, the output pins are pulled LOW.
4. If power is applied to VBATT, then a watch crystal (32.768 KHz) must be connected to the 32XIN and 32XOUT pins.

Output Configuration

The CY2291 has five independent frequency sources on-chip. These are the 32-kHz oscillator, the reference oscillator, and three Phase-locked loops (PLLs). Each PLL has a specific function. The System PLL (SPLL) drives the CLKF output and provides fixed output frequencies on the configurable outputs. The SPLL offers the most output frequency divider options. The CPU PLL (CPLL) is controlled by the select inputs (S0–S2) to provide eight user-selectable frequencies with smooth slewing between frequencies. The Utility PLL (UPLL) provides the most accurate clock. It is often used for miscellaneous frequencies not provided by the other frequency sources.

All configurations are EPROM programmable, providing short sample and production lead times. Please refer to the application note “Understanding the CY2291, CY2292, and CY2295” for information on configuring the part.

Power Saving Features

The $\overline{\text{SHUTDOWN/OE}}$ input three-states the outputs when pulled LOW (the 32-kHz clock output is not affected). If system shutdown is enabled, a LOW on this pin also shuts off the PLLs, counters, the reference oscillator, and all other active components. The resulting current on the V_{DD} pins are less than 50 μA (for Commercial Temp. or 100 μA for Industrial Temp.) plus 15 μA max. for the 32-kHz subsystem and is typically 10 μA . After leaving shutdown mode, the PLLs have to re-lock. All outputs except 32K have a weak pull down so that the outputs do not float when three-stated.^[3]

The $\overline{\text{S2/SUSPEND}}$ input can be configured to shut down a customizable set of outputs and/or PLLs, when LOW. All PLLs and any of the outputs except 32K can be shut off in nearly any combination. The only limitation is that if a PLL is shut off, all outputs derived from it must also be shut off. Suspending a PLL shuts off all associated logic, while suspending an output simply forces a three-state condition.^[2]

The CPUCLK can slew (transition) smoothly between 8 MHz and the maximum output frequency (100 MHz at 5V/80 MHz at 3.3 V for commercial temp. parts or 90 MHz at 5V/66.6 MHz at 3.3 V for industrial temp. and for field-programmed parts). This feature is extremely useful in “Green” PC and laptop applications, where reducing the frequency of operation can result in considerable power savings. This feature meets all 486 and Pentium® processor slewing requirements.

CyClocks Software

CyClocks™ is an easy-to-use application that allows you to configure any one of the EPROM programmable clocks offered by Cypress. You may specify the input frequency, PLL and output frequencies, and different functional options. Please note the output frequency ranges in this data sheet when specifying them in CyClocks to ensure that you stay within the limits. CyClocks also has a power calculation feature that allows you to see the power consumption of your specific configuration. CyClocks is a sub-application within the CyberClocks™ software. You can download a copy of CyberClocks for free on Cypress’s web site at www.cypress.com.

Cypress FTG Programmer

The Cypress frequency timing generator (FTG) Programmers is a portable programmer designed to custom program our family of EPROM field programmable clock devices. The FTG programmers connect to a PC serial port and allow users of CyClocks software to quickly and easily program any of the CY2291F, CY2292F, CY2071AF, and CY2907F devices. The ordering code for the Cypress FTG Programmer is CY3670.

Custom Configuration Request Procedure

The CY229x are EPROM-programmable devices that may be configured in the factory or in the field by a Cypress Field Application Engineer (FAE). The output frequencies requested are matched as closely as the internal PLL divider and multiplier options allow. All custom requests must be submitted to your local Cypress FAE or sales representative. The method to use to request custom configurations is:

Use CyClocks™ software. This software automatically calculates the output frequencies that can be generated by the CY229x devices and provides a print-out of final pinout which can be submitted (in electronic or print format) to your local FAE or sales representative. The CyClocks software is available free of charge from the Cypress web site (<http://www.cypress.com>) or from your local sales representative.

Once the custom request has been processed you receive a part number with a 3-digit extension (for example, CY2292SC-128) specific to the frequencies and pinout of your device. This is the part number used for samples requests and production orders.

Maximum Ratings

Exceeding maximum ratings may shorten the useful life of the device. These user guidelines are not tested.

Supply voltage -0.5 V to + 7.0 V
 DC input voltage -0.5 V to + 7.0 V
 Storage temperature -65 °C to +150 °C

Maximum soldering temperature (10 sec) 260 °C
 Junction temperature 150 °C
 Package power dissipation 750 mW
 Static discharge voltage ≥ 2000 V
 (per MIL-STD-883, Method 3015)

Operating Conditions^[5]

Parameter	Description	Part Numbers	Min	Max	Unit
V _{DD}	Supply voltage, 5.0 V operation	All	4.5	5.5	V
V _{DD}	Supply voltage, 3.3 V operation	All	3.0	3.6	V
V _{BATT[4]}	Battery backup voltage	All	2.0	5.5	V
T _A	Commercial operating temperature, ambient	CY2291/CY2291F	0	+70	°C
	Industrial operating temperature, ambient	CY2291I/CY2291FI	-40	+85	°C
C _{LOAD}	Max. load capacitance 5.0 V operation	All	-	25	pF
C _{LOAD}	Max. load capacitance 3.3 V operation	All	-	15	pF
f _{REF}	External reference crystal	All	10.0	25.0	MHz
	External reference clock ^[6, 7, 8]	All	1	30	MHz
t _{PU}	Power-up time for all VDDs to reach minimum specified voltage (power ramps must be monotonic)		0.05	50	ms

Electrical Characteristics, Commercial 5.0 V

Parameter	Description	Conditions	Min	Typ	Max	Unit
V _{OH}	HIGH-level output voltage	I _{OH} = 4.0 mA	2.4	-	-	V
V _{OL}	LOW-level output voltage	I _{OL} = 4.0 mA	-	-	0.4	V
V _{OH-32}	32.768-kHz HIGH-level output voltage	I _{OH} = 0.5 mA	V _{BATT} 0.5	-	-	V
V _{OL-32}	32.768-kHz LOW-level output voltage	I _{OL} = 0.5 mA	-	-	0.4	V
V _{IH}	HIGH-level input voltage ^[9]	Except crystal pins	2.0	-	-	V
V _{IL}	LOW-level input voltage ^[9]	Except crystal pins	-	-	0.8	V
I _{IH}	Input HIGH current	V _{IN} = V _{DD} - 0.5 V	-	<1	10	μA
I _{IL}	Input LOW current	V _{IN} = +0.5 V	-	<1	10	μA
I _{OZ}	Output leakage current	Three-state outputs	-	-	250	μA
I _{DD}	V _{DD} supply current commercial ^[10]	V _{DD} = V _{DD} Max., 5 V operation	-	75	100	mA
I _{DDS}	V _{DD} power supply current in shutdown mode ^[10]	Shutdown active, excluding V _{BATT}		10	50	μA
I _{BATT}	V _{BATT} power supply current	V _{BATT} = 3.0 V	-	5	15	μA

Notes

- Electrical parameters are guaranteed by design with these operating conditions, unless otherwise noted.
- External input reference clock must have a duty cycle between 40% and 60%, measured at V_{DD}/2.
- Please refer to Whitepaper "Crystal Parameters Recommendation for Cypress Frequency Synthesizers" for information on AC-coupling the external input reference clock.
- The oscillator circuit is optimized for a crystal reference and for external reference clocks up to 20 MHz. For external reference clocks above 20 MHz, it is recommended that a 150Ω pull up resistor to V_{DD} be connected to the Xout pin.
- Xtal inputs have CMOS thresholds.
- Load = Max., V_{IN} = 0V or V_{DD}, Typical (-104) configuration, CPUCLK = 66 MHz. Other configurations vary. Power can be approximated by the following formula (multiply by 0.65 for 3V operation): I_{DD} = 10 + 0.06 * (F_{CPLL} + F_{UPLL} + 2 * F_{SPLL}) + 0.27 * (F_{CLKA} + F_{CLKB} + F_{CLKC} + F_{CLKD} + F_{CPUCLK} + F_{CLKF} + F_{XBUF}).

Electrical Characteristics, Commercial 3.3 V

Parameter	Description	Conditions	Min	Typ	Max	Unit	
V _{OH}	HIGH-level output voltage	I _{OH} = 4.0 mA	2.4	–	–	V	
V _{OL}	LOW-level output voltage	I _{OL} = 4.0 mA	–	–	0.4	V	
V _{OH-32}	32.768-kHz HIGH-level output voltage	I _{OH} = 0.5 mA	V _{BATT} 0.5	–	–	V	
V _{OL-32}	32.768-kHz LOW-level output voltage	I _{OL} = 0.5 mA	–	–	0.4	V	
V _{IH}	HIGH-level input voltage ^[9]	Except crystal pins	2.0	–	–	V	
V _{IL}	LOW-level input voltage ^[9]	Except crystal pins	–	–	0.8	V	
I _{IH}	Input HIGH current	V _{IN} = V _{DD} – 0.5 V	–	<1	10	μA	
I _{IL}	Input LOW current	V _{IN} = +0.5 V	–	<1	10	μA	
I _{OZ}	Output leakage current	Three-state outputs	–	–	250	μA	
I _{DD}	V _{DD} supply current ^[10] commercial	V _{DD} = V _{DD} Max., 3.3 V operation	–	50	65	mA	
I _{DDS}	V _{DD} power supply current in shutdown mode ^[10]	Shutdown active, excluding V _{BATT}	CY2291/CY2291F	–	10	50	μA
I _{BATT}	V _{BATT} power supply current	V _{BATT} = 3.0 V	–	5	15	μA	

Electrical Characteristics, Industrial 5.0 V

Parameter	Description	Conditions	Min	Typ	Max	Unit	
V _{OH}	HIGH-level output voltage	I _{OH} = 4.0 mA	2.4	–	–	V	
V _{OL}	LOW-level output voltage	I _{OL} = 4.0 mA	–	–	0.4	V	
V _{OH-32}	32.768-kHz HIGH-level output voltage	I _{OH} = 0.5 mA	V _{BATT} 0.5	–	–	V	
V _{OL-32}	32.768-kHz LOW-level output voltage	I _{OL} = 0.5 mA	–	–	0.4	V	
V _{IH}	HIGH-level input voltage ^[9]	Except crystal pins	2.0	–	–	V	
V _{IL}	LOW-level input voltage ^[9]	Except crystal pins	–	–	0.8	V	
I _{IH}	Input HIGH current	V _{IN} = V _{DD} – 0.5 V	–	< 1	10	μA	
I _{IL}	Input LOW current	V _{IN} = +0.5 V	–	< 1	10	μA	
I _{OZ}	Output Leakage Current	Three-state outputs	–	–	250	μA	
I _{DD}	V _{DD} supply current ^[10] industrial	V _{DD} = V _{DD} Max., 5 V operation	–	75	110	mA	
I _{DDS}	V _{DD} power supply current in shutdown mode ^[10]	Shutdown active, excluding V _{BATT}	CY2291I/CY2291FI	–	10	100	μA
I _{BATT}	V _{BATT} power supply current	V _{BATT} = 3.0 V	–	5	15	μA	

Electrical Characteristics, Industrial 3.3 V

Parameter	Description	Conditions	Min	Typ	Max	Unit	
V _{OH}	HIGH-level output voltage	I _{OH} = 4.0 mA	2.4	–	–	V	
V _{OL}	LOW-level output voltage	I _{OL} = 4.0 mA	–	–	0.4	V	
V _{OH-32}	32.768-kHz HIGH-level output voltage	I _{OH} = 0.5 mA	V _{BATT} 0.5	–	–	V	
V _{OL-32}	32.768-kHz LOW-Level Output Voltage	I _{OL} = 0.5 mA	–	–	0.4	V	
V _{IH}	HIGH-level input voltage ^[9]	Except crystal pins	2.0	–	–	V	
V _{IL}	LOW-level input voltage ^[9]	Except crystal pins	–	–	0.8	V	
I _{IH}	Input HIGH current	V _{IN} = V _{DD} – 0.5 V	–	< 1	10	μA	
I _{IL}	Input LOW current	V _{IN} = +0.5 V	–	< 1	10	μA	
I _{OZ}	Output leakage current	Three-state outputs	–	–	250	μA	
I _{DD}	V _{DD} supply current ^[10] industrial	V _{DD} = V _{DD} max., 3.3V operation	–	50	70	mA	
I _{DDS}	V _{DD} power supply current in shutdown mode ^[10]	Shutdown active, excluding V _{BATT}	CY2291I/CY2291FI	–	10	100	μA
I _{BATT}	V _{BATT} power supply current	V _{BATT} = 3.0 V	–	5	15	μA	

Switching Characteristics, Commercial 5.0 V

Parameter	Name	Description	Min	Typ	Max	Unit	
t ₁	Output period	Clock output range, 5 V operation	CY2291	10 (100 MHz)	–	13000 (76.923 kHz)	ns
			CY2291F	11.1 (90 MHz)	–	13000 (76.923 kHz)	ns
	Output duty cycle ^[11]	Duty cycle for outputs, defined as t ₂ ÷ t ₁ ^[12] f _{OUT} ≥ 66 MHz	40%	50%	60%	–	
		Duty cycle for outputs, defined as t ₂ ÷ t ₁ ^[12] f _{OUT} < 66 MHz	45%	50%	55%	–	
t ₃	Rise time	Output clock rise time ^[13]	–	3	5	ns	
t ₄	Fall time	Output clock fall time ^[13]	–	2.5	4	ns	
t ₅	Output disable time	Time for output to enter three-state mode after SHUTDOWN/OE goes LOW	–	10	15	ns	
t ₆	Output enable time	Time for output to leave three-state mode after SHUTDOWN/OE goes HIGH	–	10	15	ns	
t ₇	Skew	Skew delay between any identical or related outputs ^[12, 15]	–	< 0.25	0.5	ns	
t ₈	CPUCLK Slew	Frequency transition rate	1.0	–	20.0	MHz/ms	

Notes

11. XBUF duty cycle depends on XTALIN duty cycle.

12. Measured at 1.4 V.

13. Measured between 0.4V and 2.4 V.

14. Jitter varies with configuration. All standard configurations sample tested at the factory conform to this limit. For more information on jitter, please refer to the WhitePaper: "Datasheet Jitter Specifications for Cypress Timing Products"

15. CLKF is not guaranteed to be in phase with CLKA-D, even if it is referenced off the same PLL

Switching Characteristics, Commercial 5.0 V (continued)

Parameter	Name	Description	Min	Typ	Max	Unit	
t _{9A}	Clock jitter ^[14]	Peak-to-peak period jitter (t _{9A} Max. – t _{9A} min.), % of clock period (f _{OUT} ≤ 4 MHz)	–	< 0.5	1	%	
t _{9B}	Clock jitter ^[14]	Peak-to-peak period jitter (t _{9B} Max. – t _{9B} min.) (4 MHz ≤ f _{OUT} ≤ 16 MHz)	–	< 0.7	1	ns	
t _{9C}	Clock jitter ^[14]	Peak-to-peak period jitter (16 MHz < f _{OUT} ≤ 50 MHz)	–	< 400	500	ps	
t _{9D}	Clock jitter ^[14]	Peak-to-peak period jitter (f _{OUT} > 50 MHz)	–	< 250	350	ps	
t _{10A}	Lock time for CPLL	Lock Time from Power-up	–	< 25	50	ms	
t _{10B}	Locktime for UPLL and SPLL	Lock Time from Power-up	–	< 0.25	1	ms	
	Slew limits	CPU PLL Slew limits	CY2291	8	–	100	MHz
			CY2291F	8	–	90	MHz

Switching Characteristics, Commercial 3.3 V

Parameter	Name	Description	Min	Typ	Max	Unit	
t ₁	Output period	Clock output range, 3.3 V operation	CY2291	12.5 (80 MHz)	–	13000 (76.923 kHz)	ns
			CY2291F	15 (66.6 MHz)	–	13000 (76.923 kHz)	ns
	Output duty cycle ^[11]	Duty cycle for outputs, defined as t ₂ ÷ t ₁ ^[12] f _{OUT} ≥ 66 MHz	40%	50%	60%	–	
		Duty cycle for outputs, defined as t ₂ ÷ t ₁ ^[12] f _{OUT} < 66 MHz	45%	50%	55%	–	
t ₃	Rise time	Output clock rise time ^[13]	–	3	5	ns	
t ₄	Fall time	Output clock fall time ^[13]	–	2.5	4	ns	
t ₅	Output disable time	Time for output to enter three-state mode after SHUTDOWN/OE goes LOW	–	10	15	ns	
t ₆	Output enable time	Time for output to leave three-state mode after SHUTDOWN/OE goes HIGH	–	10	15	ns	
t ₇	Skew	Skew delay between any identical or related outputs ^[12, 15]	–	< 0.25	0.5	ns	
t ₈	CPUCLK Slew	Frequency transition rate	1.0	–	20.0	MHz/m s	
t _{9A}	Clock jitter ^[14]	Peak-to-peak period jitter (t _{9A} Max. – t _{9A} min.), % of clock period (f _{OUT} ≤ 4 MHz)	–	< 0.5	1	%	
t _{9B}	Clock jitter ^[14]	Peak-to-peak period jitter (t _{9B} Max. – t _{9B} min.) (4 MHz ≤ f _{OUT} ≤ 16 MHz)	–	< 0.7	1	ns	
t _{9C}	Clock jitter ^[14]	Peak-to-peak period jitter (16 MHz < f _{OUT} ≤ 50 MHz)	–	< 400	500	ps	
t _{9D}	Clock jitter ^[14]	Peak-to-peak period jitter (f _{OUT} > 50 MHz)	–	< 250	350	ps	
t _{10A}	Lock time for CPLL	Lock time from power-up	–	< 25	50	ms	
t _{10B}	Lock time for UPLL and SPLL	Lock time from power-up	–	< 0.25	1	ms	
	Slew limits	CPU PLL slew limits	CY2291	8	–	80	MHz
			CY2291F	8	–	66.6	MHz

Switching Characteristics, Industrial 5.0 V

Parameter	Name	Description	Min	Typ	Max	Unit	
t ₁	Output period	Clock output range, 5 V operation	CY2291I	11.1 (90 MHz)	–	13000 (76.923 kHz)	ns
			CY2291FI	12.5 (80 MHz)	–	13000 (76.923 kHz)	ns
	Output duty cycle ^[11]	Duty cycle for outputs, defined as $t_2 \div t_1$ ^[12] f _{OUT} ≥ 66 MHz	40%	50%	60%	–	
		Duty cycle for outputs, defined as $t_2 \div t_1$ ^[12] f _{OUT} < 66 MHz	45%	50%	55%	–	
t ₃	Rise time	Output clock rise time ^[13]	–	3	5	ns	
t ₄	Fall time	Output clock fall time ^[13]	–	2.5	4	ns	
t ₅	Output disable time	Time for output to enter three-state mode after SHUTDOWN/OE goes LOW	–	10	15	ns	
t ₆	Output enable time	Time for output to leave three-state mode after SHUTDOWN/OE goes HIGH	–	10	15	ns	
t ₇	Skew	Skew delay between any identical or related outputs ^[12, 15]	–	< 0.25	0.5	ns	
t ₈	CPUCLK Slew	Frequency transition rate	1.0		20.0	MHz/m s	
t _{9A}	Clock Jitter ^[14]	Peak-to-peak period jitter (t _{9A} Max. – t _{9A} min.), % of clock period (f _{OUT} ≤ 4 MHz)	–	< 0.5	1	%	
t _{9B}	Clock jitter ^[14]	Peak-to-peak period jitter (t _{9B} Max. – t _{9B} min.) (4 MHz ≤ f _{OUT} ≤ 16 MHz)	–	< 0.7	1	ns	
t _{9C}	Clock jitter ^[14]	Peak-to-peak period jitter (16 MHz < f _{OUT} ≤ 50 MHz)	–	< 400	500	ps	
t _{9D}	Clock jitter ^[14]	Peak-to-peak period jitter (f _{OUT} > 50 MHz)	–	< 250	350	ps	
t _{10A}	Lock time for CPLL	Lock time from power-up	–	< 25	50	ms	
t _{10B}	Lock time for UPLL and SPLL	Lock time from power-up	–	< 0.25	1	ms	
	Slew limits	CPU PLL Slew limits	CY2291I	8	–	90	MHz
			CY2291FI	8	–	80	MHz

Switching Characteristics, Industrial 3.3 V

Parameter	Name	Description	Min	Typ	Max	Unit
t ₁	Output period	Clock output range, 3.3 V operation				
		CY2291I	15 (66.6 MHz)	–	13000 (76.923 kHz)	ns
		CY2291FI	16.66 (60 MHz)	–	13000 (76.923 kHz)	ns
	Output duty cycle ^[11]	Duty cycle for outputs, defined as $t_2 \div t_1$ ^[12] f _{OUT} ≥ 66 MHz	40%	50%	60%	–
		Duty cycle for outputs, defined as $t_2 \div t_1$ ^[12] f _{OUT} < 66 MHz	45%	50%	55%	–
t ₃	Rise time	Output clock rise time ^[13]	–	3	5	ns
t ₄	Fall time	Output clock fall time ^[13]	–	2.5	4	ns
t ₅	Output disable time	Time for output to enter three-state mode after SHUTDOWN/OE goes LOW	–	10	15	ns
t ₆	Output enable time	Time for output to leave three-state mode after SHUTDOWN/OE goes HIGH	–	10	15	ns
t ₇	Skew	Skew delay between any identical or related outputs ^[12, 15]	–	< 0.25	0.5	ns
t ₈	CPUCLK slew	Frequency transition rate	1.0		20.0	MHz/ms
t _{9A}	Clock jitter ^[14]	Peak-to-peak period jitter (t _{9A} Max. – t _{9A} min.), % of clock period (f _{OUT} ≤ 4 MHz)	–	< 0.5	1	%
t _{9B}	Clock jitter ^[14]	Peak-to-peak period jitter (t _{9B} Max. – t _{9B} min.) (4 MHz ≤ f _{OUT} ≤ 16 MHz)	–	< 0.7	1	ns
t _{9C}	Clock jitter ^[14]	Peak-to-peak period jitter (16 MHz < f _{OUT} ≤ 50 MHz)	–	< 400	500	ps
t _{9D}	Clock jitter ^[14]	Peak-to-peak period jitter (f _{OUT} > 50 MHz)	–	< 250	350	ps
t _{10A}	Lock time for CPLL	Lock time from power-up	–	< 25	50	ms
t _{10B}	Lock time for UPLL and SPLL	Lock time from power-up	–	< 0.25	1	ms
	Slew limits	CPU PLL slew limits				
		CY2291I	8	–	66.6	MHz
		CY2291FI	8	–	60	MHz

Switching Waveforms

Figure 2. All Outputs, Duty Cycle and Rise/Fall Time

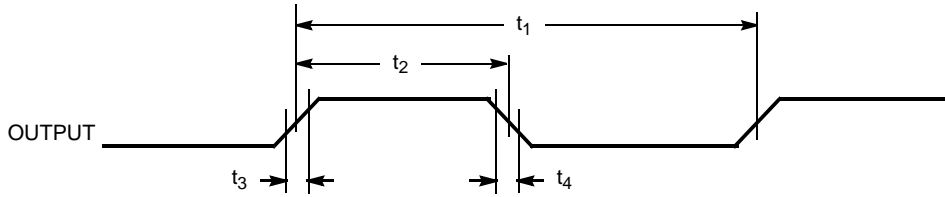

Figure 3. Output Three-State Timing [3]

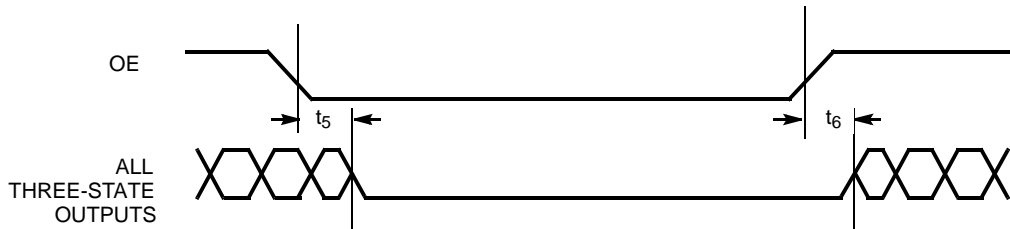

Figure 4. CLK Outputs Jitter and Skew

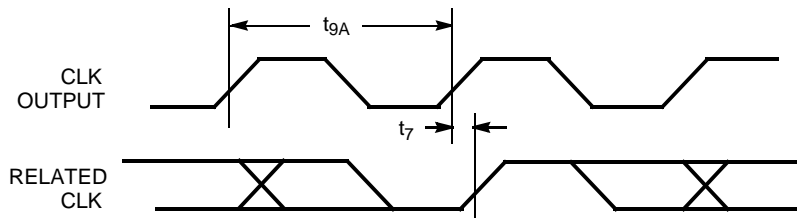
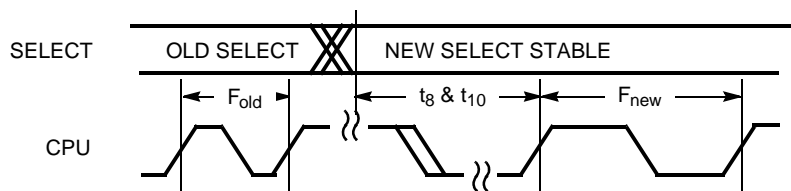
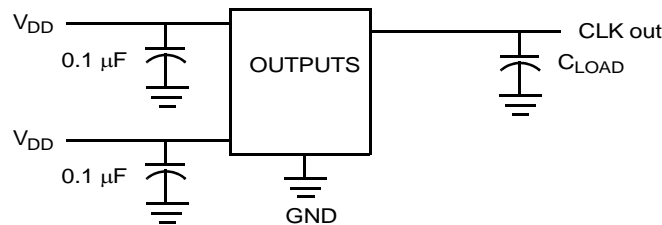

Figure 5. CPU Frequency Change



Test Circuit



Ordering Information

Ordering Code	Package Type	Operating Range	Operating Voltage
Pb-free			
CY2291FX	20-Pin SOIC	Commercial	3.3 V or 5.0 V
CY2291FXT	20-Pin SOIC – Tape and reel	Commercial	3.3 V or 5.0 V

Some product offerings are factory programmed customer specific devices with customized part numbers. The Possible Configurations table shows the available device types, but not complete part numbers. Contact your local Cypress FAE or Sales Representative for more information.

Possible Configurations

Ordering Code	Package Type	Operating Range	Operating Voltage
Pb-free			
CY2291SXC-XXX	20-Pin SOIC	Commercial	5.0 V
CY2291SXC-XXXT	20-Pin SOIC – Tape and reel	Commercial	5.0 V
CY2291SXL-XXX	20-Pin SOIC	Commercial	3.3 V
CY2291SXL-XXXT	20-Pin SOIC – Tape and reel	Commercial	3.3 V

Ordering Code Definitions

CY 2291 (F) (S) X (C) (-xxx) (T)

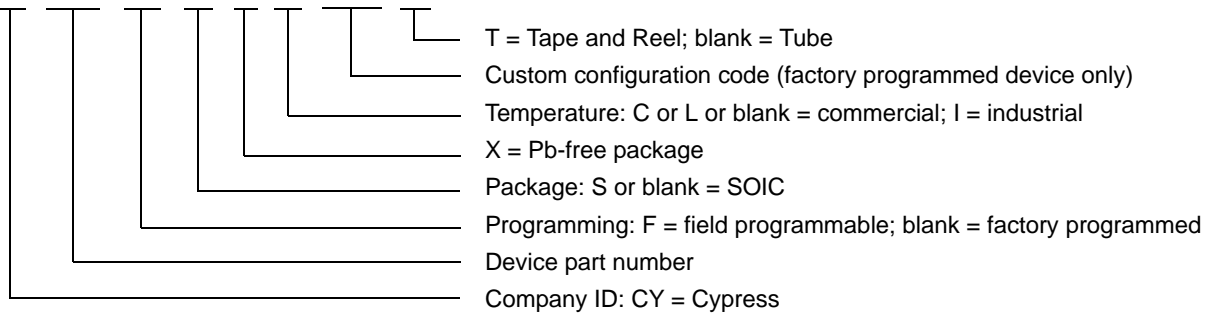

Package Characteristics

Package	θ_{JA} (C/W)	θ_{JC} (C/W)	Transistor Count
20-pin SOIC	70	46	9271

Package Diagram

Figure 6. 20-Pin (300 MIL) SOIC Package Outline

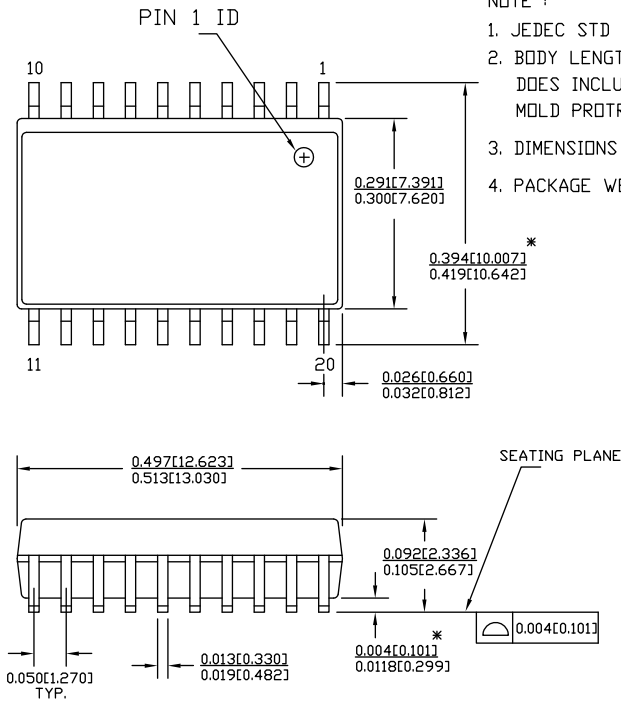

NOTE :

1. JEDEC STD REF MO-119
2. BODY LENGTH DIMENSION DOES NOT INCLUDE MOLD PROTRUSION/END FLASH,BUT DOES INCLUDE MOLD MISMATCH AND ARE MEASURED AT THE MOLD PARTING LINE. MOLD PROTRUSION/END FLASH SHALL NOT EXCEED 0.010 in (0.254 mm) PER SIDE
3. DIMENSIONS IN INCHES MIN.
MAX.
4. PACKAGE WEIGHT 0.55gms

PART #	
S20.3	STANDARD PKG.
SZ20.3	LEAD FREE PKG.

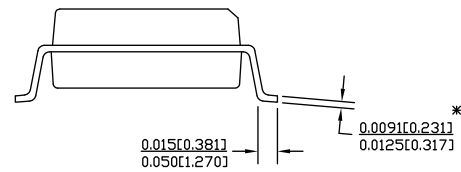

51-85024 *E

Acronyms

Acronym	Description	Acronym	Description
CLKIN	Clock input	SPLL	System Phase locked loop
CMOS	complementary metal oxide semiconductor	PPM	Parts per million
OE	Output enable	FTG	Frequency time generator
PLL	Phase locked loop	FAE	Field application engineer

Document Conventions

Units of Measure

Symbol	Unit of Measure	Symbol	Unit of Measure
°C	degrees Celsius	μV	microvolt
fF	femtofarad	mA	milliampere
KB	1024 bytes	ms	millisecond
Kbit	1024 bits	nA	nanoampere
kHz	kilohertz	ns	nanosecond
MHz	megahertz	nV	nanovolt
M?	megaohm	pA	picoampere
μA	microampere	pF	picofarad
μF	microfarad	pp	peak-to-peak
μH	microhenry	ppm	parts per million
μs	microsecond	ps	picosecond

Document History Page

Document Title: CY2291 Three-PLL General Purpose EPROM Programmable Clock Generator				
Document Number: 38-07189				
Revision	ECN	Orig. of Change	Submission Date	Description of Change
**	110321	SZV	10/28/01	Change from Spec number: 38-00410 to 38-07189
*A	121836	RBI	12/14/02	Power up requirements added to Operating Conditions Information
*B	276756	RGL	10/18/04	Added Lead Free Devices
*C	2565316	AESA/KVM	09/16/08	Updated template. Added Note "Not recommended for new designs." Removed part number CY2291F, CY2291FT, CY2291SC-XXX, CY2291SC-XXXT, CY2291SI-XXX, CY2291SI-XXXT, CY2291SL-XXX, CY2291SL-XXXT, CY2291FIT, CY2291SXI-XXX, CY2291SXI-XXXT, CY2291FXI and CY2291FXIT. Changed CyClocks reference to include CyberClocks. Changed Lead-free to Pb-free. Updated Package diagram 51-85024 *B to 51-85024 *C.
*D	2898985	KVM	03/25/2010	Updated Ordering Information . Added note regarding Possible Configurations in Ordering Information section. Added Possible Configurations table for "xxx" parts. Updated Package Diagram
*E	3080949	BASH	11/10/2010	Removed Benefits and Added Functional Description content Removed Operation content from the datasheet. Updated as per new template Added Acronyms and Units of Measure table Added Possible Configurations
*F	3450141	PURU	01/12/2011	Added note 4 regarding VBATT and Watch crystal Removed multiple occurrences of many notes Changed θ_{JA} and θ_{JC} values to 70 and 46 respectively under Package Characteristics section.