

High-Performance LVDS Oscillator with Frequency Margining – Pin Control

Features

- Low jitter crystal oscillator (XO)
- Less than 1 ps typical RMS phase jitter
- Differential LVDS output
- Output frequency from 50 MHz to 690 MHz
- Two frequency margining control pins (FS0, FS1)
- Factory configured or field programmable
- Integrated phase-locked loop (PLL)
- Supply voltage: 3.3 V or 2.5 V
- Pb-free package: 5.0 × 3.2 mm LCC
- Industrial temperature range

Functional Description

The CY2XF33 is a high-performance and high-frequency crystal oscillator (XO). It uses a Cypress proprietary low-noise PLL to synthesize the frequency from an integrated crystal. The output frequency can be changed through two select pins, allowing easy frequency margin testing in applications.

The CY2XF33 is available as a factory configured device or as a field programmable device.

Logic Block Diagram

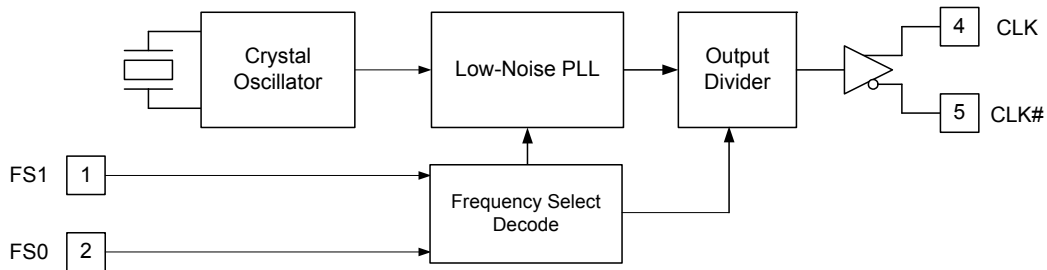

Contents

Pinouts	3	Ordering Information	9
Pin Definitions	3	Possible Configuration	9
Functional Description	4	Ordering Code Definitions	9
Programming Description	4	Package Drawings and Dimensions	10
Field Programmable CY2XF33F	4	Acronyms	11
Factory Configured CY2XF33	4	Document Conventions	11
Programming Variables	4	Units of Measure	11
Output Frequencies	4	Document History Page	12
Industrial Versus Commercial Device Performance	4	Sales, Solutions, and Legal Information	14
Phase Noise Versus Jitter Performance	4	Worldwide Sales and Design Support	14
Absolute Maximum Conditions	5	Products	14
Operating Conditions	5	PSoC@Solutions	14
DC Electrical Characteristics	6	Cypress Developer Community	14
Termination Circuits	6	Technical Support	14
AC Electrical Characteristics	7		
Switching Waveforms	8		

Pinouts

Figure 1. 6-pin Ceramic LCC pinout

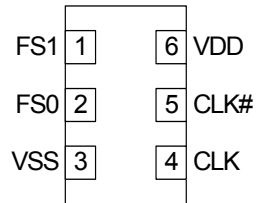

Pin Definitions

6-pin Ceramic LCC

Pin	Name	I/O Type	Description
1, 2	FS1, FS0	CMOS input	Frequency select
4, 5	CLK, CLK#	LVDS output	Differential output clock
6	VDD	Power	Supply voltage: 2.5 V or 3.3 V
3	VSS	Power	Ground

Functional Description

The FS0 and FS1 pins select between four different output frequencies, as shown in Table 1. Frequency margining is a common application for this feature. One frequency is used for the standard operating mode of the device, while the other frequencies are available for margin testing, either during product development or in system manufacturing test.

Table 1. Frequency Select

FS1	FS0	Output Frequency
0	0	Frequency 0
0	1	Frequency 1
1	0	Frequency 2
1	1	Frequency 3

When changing the output frequency, the frequency transition is not guaranteed to be smooth. There can be frequency excursions beyond the start frequency and the new frequency. Glitches and runt pulses are possible, and time must be allowed for the PLL to relock.

Programming Description

The CY2XF33 is a programmable device. Before being used in an application, it must be programmed with the output frequencies and other variables described in a later section. Two different device types are available, each with its own programming flow. They are described in the following sections.

Field Programmable CY2XF33F

Field programmable devices are shipped unprogrammed and must be programmed before being installed on a printed circuit board (PCB). Customers use CyberClocks™ Online Software to specify the device configuration and generate a JEDEC (extension .jed) programming file. Programming of samples and prototype quantities is available using a Cypress programmer. Third party vendors manufacture programmers for small to large volume applications. Cypress's value added distribution partners also provide programming services. Field programmable devices are designated with an "F" in the part number. They are intended for quick prototyping and inventory reduction. The CY2XF33 is one time programmable (OTP).

Factory Configured CY2XF33

For customers wanting ready-to-use devices, the CY2XF33 is available with no field programming required. All requests are

submitted to the local Cypress Field Application Engineer (FAE) or sales representative. After the request is processed, the user receives a new part number, samples, and data sheet with the programmed values. This part number is used for additional sample requests and production orders.

Programming Variables

Output Frequencies

The CY2XF33 is programmed with up to four independent output frequencies, which are then selected using the FS0 and FS1 pins. The device can synthesize frequencies to a resolution of 1 part per million (ppm), but the actual accuracy of the output frequency is limited by the accuracy of the integrated reference crystal.

The CY2XF33 has an output frequency range of 50 MHz to 690 MHz, but the range is not continuous. The CY2XF33 cannot generate frequencies in the ranges of 521 MHz to 529 MHz and 596 MHz to 617 MHz.

Industrial Versus Commercial Device Performance

Industrial and Commercial devices have different internal crystals. This has a potentially significant impact on performance levels for applications requiring the lowest possible phase noise. CyberClocks Online Software displays expected performance for both options.

Phase Noise Versus Jitter Performance

In most cases, the device configuration for optimal phase noise performance is different from the device configuration for optimal cycle to cycle or period jitter. CyberClocks Online Software includes algorithms to optimize performance for either parameter.

Table 2. Device Programming Variables

Variable
Output frequency 0 (Power on default)
Output frequency 1
Output frequency 2
Output frequency 3
Optimization (phase noise or jitter)
Temperature range (Industrial)

Absolute Maximum Conditions

Parameter	Description	Condition	Min	Max	Unit
V_{DD}	Supply voltage	–	–0.5	4.4	V
$V_{IN}^{[1]}$	Input voltage, DC	Relative to V_{SS}	–0.5	$V_{DD} + 0.5$	V
T_S	Temperature, storage	Non operating	–55	135	°C
T_J	Temperature, junction	–	–40	135	°C
ESD_{HBM}	ESD protection (human body model)	JEDEC STD 22-A114-B	2000	–	V
$\theta_{JA}^{[2]}$	Thermal resistance, junction to ambient	0 m/s airflow	64		°C/W

Operating Conditions

Parameter	Description	Min	Typ	Max	Unit
V_{DD}	3.3 V supply voltage range	3.135	3.3	3.465	V
	2.5 V supply voltage range	2.375	2.5	2.625	V
T_{PU}	Power up time for V_{DD} to reach minimum specified voltage (power ramp is monotonic)	0.05	–	500	ms
T_A	Ambient temperature (industrial)	–40	–	85	°C

Notes

1. The voltage on any input or I/O pin cannot exceed the power pin during power up.
2. Simulated. The board is derived from the JEDEC multilayer standard. It measures 76 x 114 x 1.6 mm and has 4-layers of copper (2/1/1/2 oz.). The internal layers are 100% copper planes, while the top and bottom layers have 50% metalization. No vias are included in the model.

DC Electrical Characteristics

Parameter	Description	Condition	Min	Typ	Max	Unit
$I_{DD}^{[3]}$	Operating supply current	$V_{DD} = 3.465\text{ V}$, CLK = 150 MHz, output terminated	–	–	120	mA
		$V_{DD} = 2.625\text{ V}$, CLK = 150 MHz, output terminated	–	–	115	mA
V_{OD}	LVDS differential output voltage	$V_{DD} = 3.3\text{ V}$ or 2.5 V , defined in Figure 3 as terminated in Figure 2	247	–	454	mV
ΔV_{OD}	Change in V_{OD} between complementary output states	$V_{DD} = 3.3\text{ V}$ or 2.5 V , defined in Figure 3 as terminated in Figure 2	–	–	50	mV
V_{OS}	LVDS offset output voltage	$V_{DD} = 3.3\text{ V}$ or 2.5 V , defined in Figure 4 as terminated in Figure 2	1.125	–	1.375	V
ΔV_{OS}	Change in V_{OS} between complementary output states	$V_{DD} = 3.3\text{ V}$ or 2.5 V , $R_{TERM} = 100\ \Omega$ between CLK and CLK#	–	–	50	mV
V_{IH}	Input high voltage	–	$0.7 \times V_{DD}$	–	–	V
V_{IL}	Input low voltage	–	–	–	$0.3 \times V_{DD}$	V
I_{IH0}	Input high current, FS0 pin	Input = V_{DD}	–	–	115	μA
I_{IH1}	Input high current, FS1 pin	Input = V_{DD}	–	–	10	μA
I_{IL0}	Input low current, FS0 pin	Input = V_{SS}	–50	–	–	μA
I_{IL1}	Input low current, FS1 pin	Input = V_{SS}	–20	–	–	μA
$C_{IN0}^{[4]}$	Input capacitance, FS0 pin	–	–	15	–	pF
$C_{IN1}^{[4]}$	Input capacitance, FS1 pin	–	–	4	–	pF

Termination Circuits

Figure 2. LVDS Termination

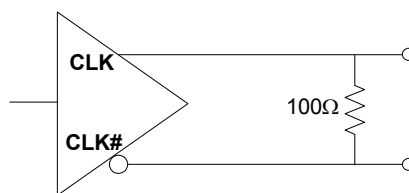

Notes

- I_{DD} includes ~4 mA of current that is dissipated externally in the output termination resistors.
- Not 100% tested, guaranteed by design and characterization.

AC Electrical Characteristics

Parameter ^[5]	Description	Condition	Min	Typ	Max	Unit
F _{OUT}	Output frequency ^[6]	–	50	–	690	MHz
FSI	Frequency stability, industrial devices ^[7]	T _A = –40 °C to 85 °C	–	–	±55	ppm
AG	Aging, 10 years	–	–	–	±15	ppm
T _{DC}	Output duty cycle	F ≤ 450 MHz, measured at zero crossing	45	50	55	%
		F > 450 MHz, measured at zero crossing	40	50	60	%
T _R , T _F	Output rise and fall time	20% and 80% of full output swing	–	0.35	1.0	ns
T _{LOCK}	Startup time	Time for CLK to reach valid frequency measured from the time V _{DD} = V _{DD(min)}	–	–	5	ms
T _{LFS}	Re-lock time	Time for CLK to reach valid frequency from FS0 or FS1 pin change	–	–	1	ms
T _{Jitter(φ)}	RMS phase jitter (random)	f _{OUT} = 106.25 MHz (12 kHz–20 MHz)	–	1	–	ps

Notes

5. Not 100% tested, guaranteed by design and characterization.
6. This parameter is specified in CyberClocks Online software.
7. Frequency stability is the maximum variation in frequency from F₀. It includes initial accuracy, plus variation from temperature and supply voltage.

Switching Waveforms

Figure 3. Output Voltage Swing

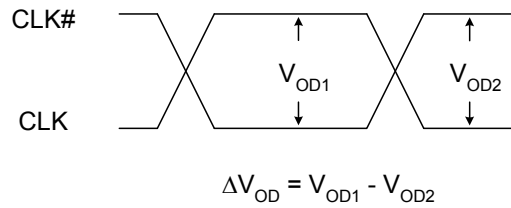

Figure 4. Output Offset Voltage

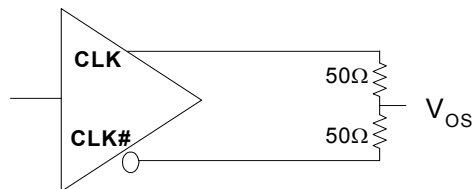

Figure 5. Output Duty Cycle Timing

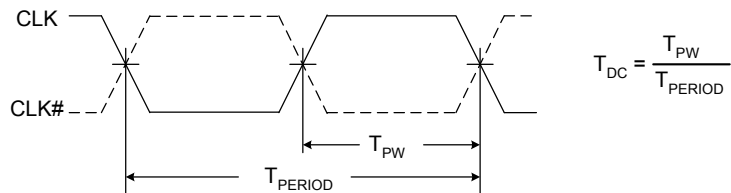

Figure 6. Output Rise and Fall Time

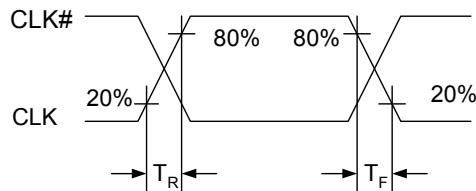
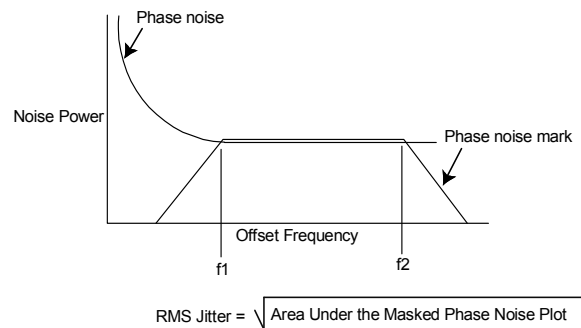

Figure 7. RMS Phase Jitter



Ordering Information

Part Number	Configuration	Package Description	Product Flow
Pb-free			
CY2XF33FLXIT	Field programmable	6-pin ceramic LCC SMD – Tape and Reel	Industrial, –40 °C to 85 °C

Possible Configuration

Some product offerings are factory programmed customer specific devices with customized part numbers. The Possible Configurations table shows the available device types, but not complete part numbers. Contact your local Cypress FAE or Sales Representative for more information.

Part Number ^[8]	Configuration	Package Description	Product Flow
Pb-free			
CY2XF33LXIxxxT	Factory configured	6-pin ceramic LCC SMD – Tape and Reel	Industrial, –40 °C to 85 °C

Ordering Code Definitions

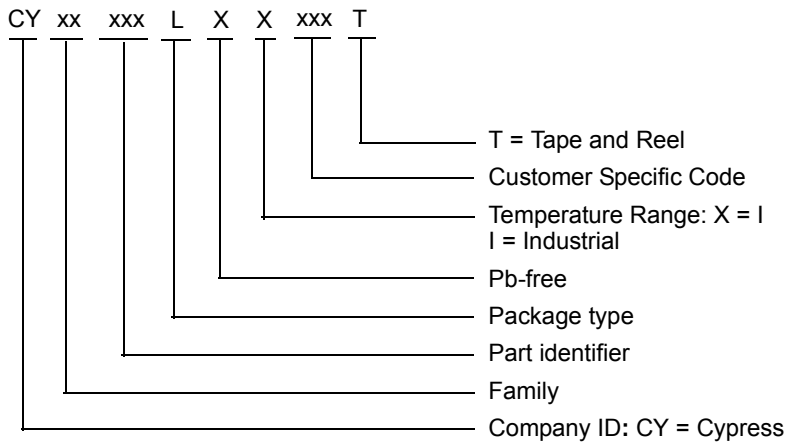

Note

8. "xxx" is a factory assigned code that identifies the programming option. For more details, contact your local Cypress FAE or Sales Representative.

Package Drawings and Dimensions

Figure 8. 6-pin Ceramic LCC (5.0 × 3.2 × 1.3 mm) LZ06A Package Outline, 001-10044

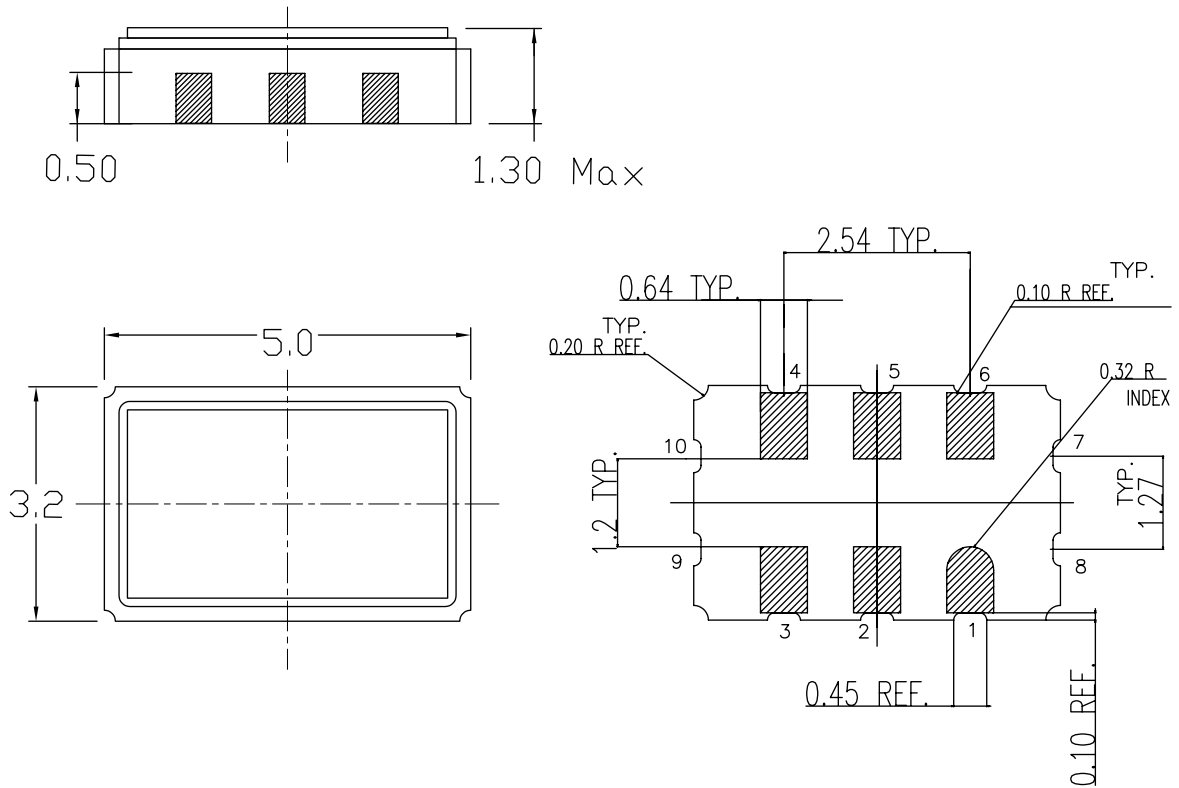

Dimensions in mm
Kyocera dwg ref KD-VA6432-A
Package Weight ~ 0.12 grams

001-10044 *C

Acronyms

Acronym	Description
CLKOUT	clock output
CMOS	complementary metal oxide semiconductor
DPM	die pick map
EPROM	erasable programmable read only memory
LVDS	low-voltage differential signaling
NTSC	national television system committee
OE	output enable
PAL	phase alternate line
PD	power-down
PLL	phase-locked loop
PPM	parts per million
TTL	transistor-transistor logic

Document Conventions

Units of Measure

Symbol	Unit of Measure
°C	degree Celsius
kHz	kilohertz
kΩ	kilohm
MHz	megahertz
MΩ	megaohm
μA	microampere
μs	microsecond
μV	microvolt
μVrms	microvolts root-mean-square
mA	milliampere
mm	millimeter
ms	millisecond
mV	millivolt
nA	nanoampere
ns	nanosecond
nV	nanovolt
Ω	ohm

Document History Page

Document Title: CY2XF33, High-Performance LVDS Oscillator with Frequency Margining – Pin Control				
Document Number: 001-53148				
Revision	ECN	Orig. of Change	Submission Date	Description of Change
**	2704379	KVM / PYRS	05/11/2009	New data sheet.
*A	2734005	WWZ	07/09/2009	Post to external web.
*B	2764787	KVM	09/18/2009	Updated DC Electrical Characteristics : Changed minimum value of V_{OD} parameter from 250 mV to 247 mV. Changed maximum value of V_{OD} parameter from 450 mV to 454 mV. Updated AC Electrical Characteristics : Added maximum value for T_R , T_F parameter as 1.0 ns. Changed maximum value of T_{LOCK} parameter from 10 ms to 5 ms. Changed maximum value of T_{LFS} parameter from 10 ms to 1 ms.
*C	2898472	KVM	03/24/2010	Updated Ordering Information : No change in part numbers. Added Possible Configuration . Moved 'xxx' parts to Possible Configurations table. Updated Package Drawings and Dimensions .
*D	3165931	BASH	02/10/2011	Changed status from Preliminary to Final. Added "Application Specific Factory Configurations". Updated Ordering Information : Updated part numbers (Added application specific part numbers). Added note "Device configuration details are described in the "Application-Specific Factory Configurations" on page 4." and referred the same note in newly added MPNs.
*E	3279652	BASH	06/13/2011	Updated Logic Block Diagram : Swapped FS0 and FS1. Updated Pinouts : Updated Figure 1 : Swapped FS0 and FS1. Updated Pin Definitions : Swapped FS0 and FS1 in "Name" column. Updated Application Specific Factory Configurations: Removed CY2XF33LXC533T related information Updated Ordering Information : Updated part numbers (Removed CY2XF33LXC533T).
*F	3847770	AJU	01/23/2013	Removed "Application-Specific Factory Configurations". Updated Ordering Information : Removed pruned part CY2XF33LXC700T. Removed the Note "Device configuration details are described in the "Application-Specific Factory Configurations" on page 4." and its references. Updated Package Drawings and Dimensions : spec 001-10044 – Changed revision from *A to *B.
*G	4292282	XHT	See ECN	Obsolete document. Completing Sunset Review.

Document History Page (continued)

Document Title: CY2XF33, High-Performance LVDS Oscillator with Frequency Margining – Pin Control Document Number: 001-53148				
Revision	ECN	Orig. of Change	Submission Date	Description of Change
*H	5364178	PSR	07/21/2016	Reactivated document. Removed Commercial Temperature Range related information in all instances across the document. Updated Programming Description : Updated Field Programmable CY2XF33F : Updated description. Updated Ordering Information : Updated part numbers. Updated Possible Configuration : Updated part numbers. Updated Package Drawings and Dimensions : spec 001-10044 – Changed revision from *B to *C. Updated to new template. Completing Sunset Review.
*I	5992952	AESATMP9	12/14/2017	Updated logo and copyright.

Sales, Solutions, and Legal Information

Worldwide Sales and Design Support

Cypress maintains a worldwide network of offices, solution centers, manufacturer's representatives, and distributors. To find the office closest to you, visit us at [Cypress Locations](#).

Products

Arm® Cortex® Microcontrollers	cypress.com/arm
Automotive	cypress.com/automotive
Clocks & Buffers	cypress.com/clocks
Interface	cypress.com/interface
Internet of Things	cypress.com/iot
Memory	cypress.com/memory
Microcontrollers	cypress.com/mcu
PSoC	cypress.com/psoc
Power Management ICs	cypress.com/pmic
Touch Sensing	cypress.com/touch
USB Controllers	cypress.com/usb
Wireless Connectivity	cypress.com/wireless

PSoC® Solutions

[PSoC 1](#) | [PSoC 3](#) | [PSoC 4](#) | [PSoC 5LP](#) | [PSoC 6 MCU](#)

Cypress Developer Community

[Community](#) | [Projects](#) | [Video](#) | [Blogs](#) | [Training](#) | [Components](#)

Technical Support

cypress.com/support

© Cypress Semiconductor Corporation, 2009-2017. This document is the property of Cypress Semiconductor Corporation and its subsidiaries, including Spansion LLC ("Cypress"). This document, including any software or firmware included or referenced in this document ("Software"), is owned by Cypress under the intellectual property laws and treaties of the United States and other countries worldwide. Cypress reserves all rights under such laws and treaties and does not, except as specifically stated in this paragraph, grant any license under its patents, copyrights, trademarks, or other intellectual property rights. If the Software is not accompanied by a license agreement and you do not otherwise have a written agreement with Cypress governing the use of the Software, then Cypress hereby grants you a personal, non-exclusive, nontransferable license (without the right to sublicense) (1) under its copyright rights in the Software (a) for Software provided in source code form, to modify and reproduce the Software solely for use with Cypress hardware products, only internally within your organization, and (b) to distribute the Software in binary code form externally to end users (either directly or indirectly through resellers and distributors), solely for use on Cypress hardware product units, and (2) under those claims of Cypress's patents that are infringed by the Software (as provided by Cypress, unmodified) to make, use, distribute, and import the Software solely for use with Cypress hardware products. Any other use, reproduction, modification, translation, or compilation of the Software is prohibited.

TO THE EXTENT PERMITTED BY APPLICABLE LAW, CYPRESS MAKES NO WARRANTY OF ANY KIND, EXPRESS OR IMPLIED, WITH REGARD TO THIS DOCUMENT OR ANY SOFTWARE OR ACCOMPANYING HARDWARE, INCLUDING, BUT NOT LIMITED TO, THE IMPLIED WARRANTIES OF MERCHANTABILITY AND FITNESS FOR A PARTICULAR PURPOSE. To the extent permitted by applicable law, Cypress reserves the right to make changes to this document without further notice. Cypress does not assume any liability arising out of the application or use of any product or circuit described in this document. Any information provided in this document, including any sample design information or programming code, is provided only for reference purposes. It is the responsibility of the user of this document to properly design, program, and test the functionality and safety of any application made of this information and any resulting product. Cypress products are not designed, intended, or authorized for use as critical components in systems designed or intended for the operation of weapons, weapons systems, nuclear installations, life-support devices or systems, other medical devices or systems (including resuscitation equipment and surgical implants), pollution control or hazardous substances management, or other uses where the failure of the device or system could cause personal injury, death, or property damage ("Unintended Uses"). A critical component is any component of a device or system whose failure to perform can be reasonably expected to cause the failure of the device or system, or to affect its safety or effectiveness. Cypress is not liable, in whole or in part, and you shall and hereby do release Cypress from any claim, damage, or other liability arising from or related to all Unintended Uses of Cypress products. You shall indemnify and hold Cypress harmless from and against all claims, costs, damages, and other liabilities, including claims for personal injury or death, arising from or related to any Unintended Uses of Cypress products.

Cypress, the Cypress logo, Spansion, the Spansion logo, and combinations thereof, WICED, PSoC, CapSense, EZ-USB, F-RAM, and Traveo are trademarks or registered trademarks of Cypress in the United States and other countries. For a more complete list of Cypress trademarks, visit cypress.com. Other names and brands may be claimed as property of their respective owners.