

## Features

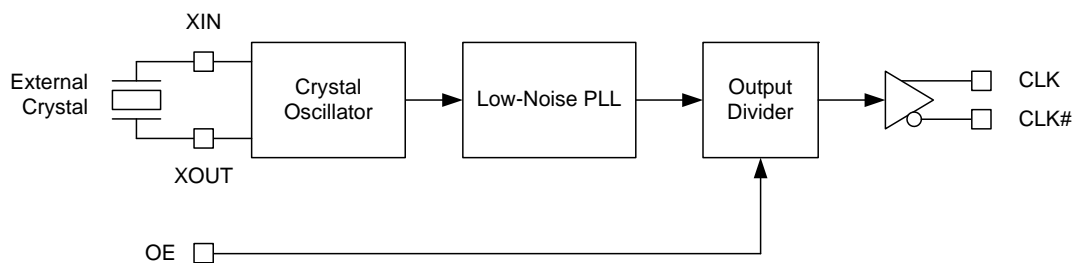
- One low-voltage differential signaling (LVDS) output pair
- Output frequency: 100 MHz
- External crystal frequency: 25 MHz
- Low RMS phase jitter at 100 MHz, using 25 MHz crystal (637 kHz to 10 MHz): 0.53 ps (typical)
- Pb-free 8-Pin TSSOP package
- Supply voltage: 3.3 V or 2.5 V
- Commercial temperature range

## Functional Description

The CY2XL11 is a PLL based high performance clock generator with a crystal oscillator interface and one LVDS output pair. It is optimized to generate PCI Express, FC, and other high-performance clock frequencies. It also produces an output frequency that is four times the crystal frequency. It uses Cypress's low-noise VCO technology to achieve less than 1 ps typical RMS phase jitter, that meets high-performance systems' jitter requirements.

For a complete list of related documentation, [click here](#).

## Logic Block Diagram



## Contents

<b>Pinouts</b> .....	<b>3</b>	<b>Package Drawing and Dimensions</b> .....	<b>10</b>
<b>Pin Definitions</b> .....	<b>3</b>	<b>Acronyms</b> .....	<b>11</b>
<b>Frequency Table</b> .....	<b>4</b>	<b>Document Conventions</b> .....	<b>11</b>
<b>Absolute Maximum Conditions</b> .....	<b>4</b>	Units of Measures .....	11
<b>Operating Conditions</b> .....	<b>4</b>	<b>Document History Page</b> .....	<b>12</b>
<b>DC Electrical Characteristics</b> .....	<b>5</b>	<b>Sales, Solutions, and Legal Information</b> .....	<b>13</b>
<b>AC Electrical Characteristics</b> .....	<b>6</b>	Worldwide Sales and Design Support .....	13
<b>Crystal Characteristics</b> .....	<b>6</b>	Products .....	13
<b>Switching Waveforms</b> .....	<b>7</b>	PSoC® Solutions .....	13
<b>Termination Circuits</b> .....	<b>8</b>	Cypress Developer Community .....	13
<b>Ordering Information</b> .....	<b>9</b>	Technical Support .....	13
Ordering Code Definitions .....	9		

## Pinouts

Figure 1. 8-pin TSSOP pinout



## Pin Definitions

Pin Number	Pin Name	I/O Type	Description
1, 8	VDD	Power	3.3 V or 2.5 V power supply. All supply current flows through pin 1
2	VSS	Power	Ground
3, 4	XOUT, XIN	XTAL output and input	Parallel resonant crystal interface
5	OE	CMOS input	Output enable. When HIGH, the output is enabled. When LOW, the output is high-impedance
6,7	CLK#, CLK	LVDS output	Differential clock output

## Frequency Table

Input Crystal Frequency (MHz)	PLL Multiplier Value	Output Frequency (MHz)
25	4	100

## Absolute Maximum Conditions

Parameter	Description	Condition	Min	Max	Unit
$V_{DD}$	Supply voltage	–	–0.5	4.4	V
$V_{IN}^{[1]}$	Input voltage, DC	Relative to $V_{SS}$	–0.5	$V_{DD} + 0.5$	V
$T_S$	Temperature, storage	Non operating	–65	150	°C
$T_J$	Temperature, junction	–	–	135	°C
$ESD_{HBM}$	ESD protection (human body model)	JEDEC STD 22-A114-B	2000	–	V
UL–94	Flammability rating	At 1/8 inch	V–0		
$\Theta_{JA}^{[2]}$	Thermal resistance, junction to ambient	0 m/s airflow	100		°C/W
		1 m/s airflow	91		
		2.5 m/s airflow	87		

## Operating Conditions

Parameter	Description	Min	Max	Unit
$V_{DD}$	3.3 V supply voltage	3.135	3.465	V
	2.5 V supply voltage	2.375	2.625	V
$T_A$	Ambient temperature	–5	70	°C
$T_{PU}$	Power up time for all $V_{DD}$ to reach minimum specified voltage (ensure power ramps is monotonic)	0.05	500	ms

### Notes

1. The voltage on any input or IO pin cannot exceed the power pin during power up.
2. Simulated using Apache Sentinel TI software. The board is derived from the JEDEC multilayer standard. It measures 76 x 114 x 1.6 mm and has 4-layers of copper (2/1/1/2 oz.). The internal layers are 100% copper planes, while the top and bottom layers have 50% metalization. No vias are included in the model.

## DC Electrical Characteristics

Parameter	Description	Test Conditions	Min	Typ	Max	Unit
$I_{DD}^{[4]}$	Power supply current with output terminated	$V_{DD} = 3.465\text{ V}$ , $OE = V_{DD}$ , output terminated	–	–	120	mA
		$V_{DD} = 2.625\text{ V}$ , $OE = V_{DD}$ , output terminated	–	–	115	mA
$V_{OD}^{[6]}$	LVDS differential output voltage	$V_{DD} = 3.3\text{ V}$ or $2.5\text{ V}$ , $R_{TERM} = 100\ \Omega$ between CLK and CLK#	247	–	454	mV
$\Delta V_{OD}^{[6]}$	Change in $V_{OD}$ between complementary output states	$V_{DD} = 3.3\text{ V}$ or $2.5\text{ V}$ , $R_{TERM} = 100\ \Omega$ between CLK and CLK#	–	–	50	mV
$V_{OS}^{[7]}$	LVDS offset output voltage	$V_{DD} = 3.3\text{ V}$ or $2.5\text{ V}$ , $R_{TERM} = 100\ \Omega$ between CLK and CLK#	1.125	–	1.375	V
$\Delta V_{OS}$	Change in $V_{OS}$ between complementary output states	$V_{DD} = 3.3\text{ V}$ or $2.5\text{ V}$ , $R_{TERM} = 100\ \Omega$ between CLK and CLK#	–	–	50	mV
$I_{OZ}$	Output leakage current	Three-state output, unterminated, measured on one pin while floating the other pin, $OE = V_{SS}$	–35	–	35	$\mu\text{A}$
$V_{IH}$	Input high voltage, OE pin	–	$0.7 \times V_{DD}$	–	–	V
$V_{IL}$	Input low voltage, OE pin	–	–	–	$0.3 \times V_{DD}$	V
$I_{IH}$	Input high current, OE pin	$OE = V_{DD}$	–	–	115	$\mu\text{A}$
$I_{IL}$	Input low current, OE pin	$OE = V_{SS}$	–50	–	–	$\mu\text{A}$
$C_{IN}$	Input capacitance, OE pin	–	–	15	–	pF
$C_{INX}$	Pin capacitance, XIN & XOUT	–	–	4.5	–	pF

### Notes

3. Outputs are terminated with 100 $\Omega$  between CLK and CLK#. Refer to [Figure 8 on page 8](#).
4.  $I_{DD}$  includes ~4 mA of current that is dissipated externally in the output termination resistor.
5. Not 100% tested, guaranteed by design and characterization.
6. Refer to [Figure 2 on page 7](#).
7. Refer to [Figure 3 on page 7](#).

## AC Electrical Characteristics

Parameter <sup>[8]</sup>	Description	Test Conditions	Min	Typ	Max	Unit
F <sub>OUT</sub>	Output frequency	–	–	100	–	MHz
T <sub>R</sub> , T <sub>F</sub> <sup>[9]</sup>	Output rise or fall time	20% to 80% of full output swing	–	0.5	1.0	ns
T <sub>Jitter(φ)</sub> <sup>[10]</sup>	RMS phase jitter (random)	F <sub>OUT</sub> = 100 MHz, (637 kHz–10 MHz)	–	0.53	–	ps
T <sub>DC</sub> <sup>[11]</sup>	Duty cycle	Measured at zero crossing point	45	–	55	%
T <sub>OHZ</sub> <sup>[12]</sup>	Output disable time	Time from falling edge on OE to stopped outputs (Asynchronous)	–	–	100	ns
T <sub>OE</sub> <sup>[12]</sup>	Output enable time	Time from rising edge on OE to outputs at a valid frequency (Asynchronous)	–	–	120	ns
T <sub>LOCK</sub>	Startup time	Time for CLK to reach valid frequency measured from the time V <sub>DD</sub> = V <sub>DD(min.)</sub>	–	–	5	ms

## Crystal Characteristics

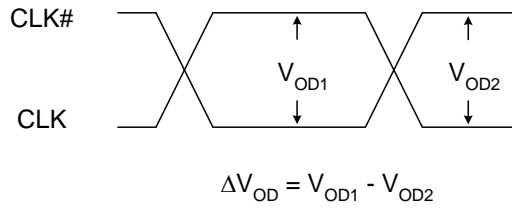
Parameter	Description	Min	Max	Unit
	Mode of oscillation	Fundamental		–
F	Frequency	25	25	MHz
ESR	Equivalent series resistance	–	50	Ω
C <sub>S</sub>	Shunt capacitance	–	7	pF

### Notes

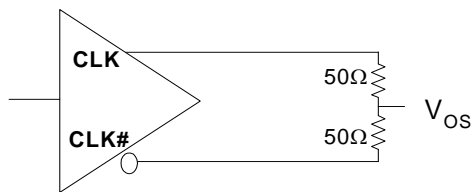
8. Outputs are terminated with 100Ω between CLK and CLK#. Refer to [Figure 8 on page 8](#).
9. Refer to [Figure 4 on page 7](#).
10. Refer to [Figure 7 on page 8](#).
11. Refer to [Figure 5 on page 7](#).
12. Refer to [Figure 6 on page 7](#).

## Switching Waveforms

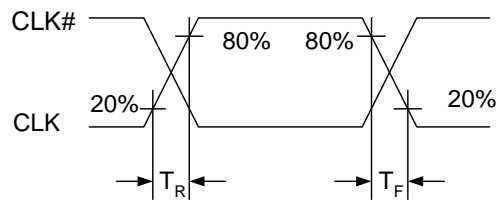
**Figure 2. Output Voltage Swing**



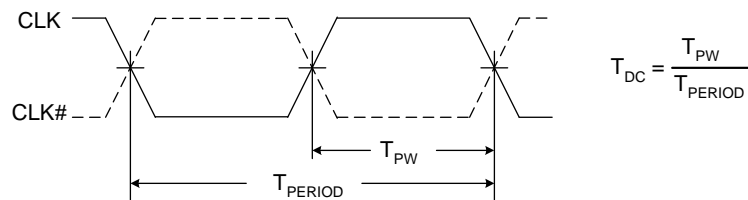
**Figure 3. Output Offset Voltage**



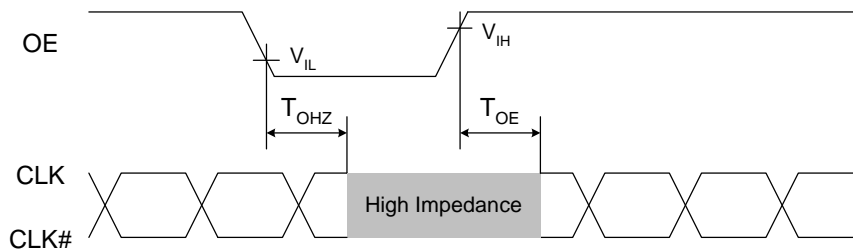
**Figure 4. Output Rise or Fall Time**



**Figure 5. Duty Cycle Timing**

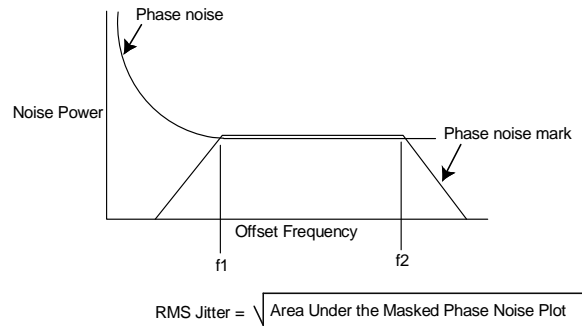


**Figure 6. Output Enable and Disable Timing**



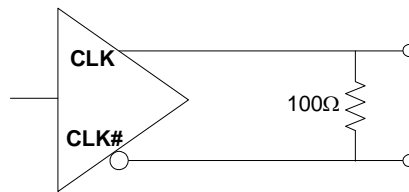
**Switching Waveforms** (continued)

**Figure 7. RMS Phase Jitter**



**Termination Circuits**

**Figure 8. LVDS Termination**

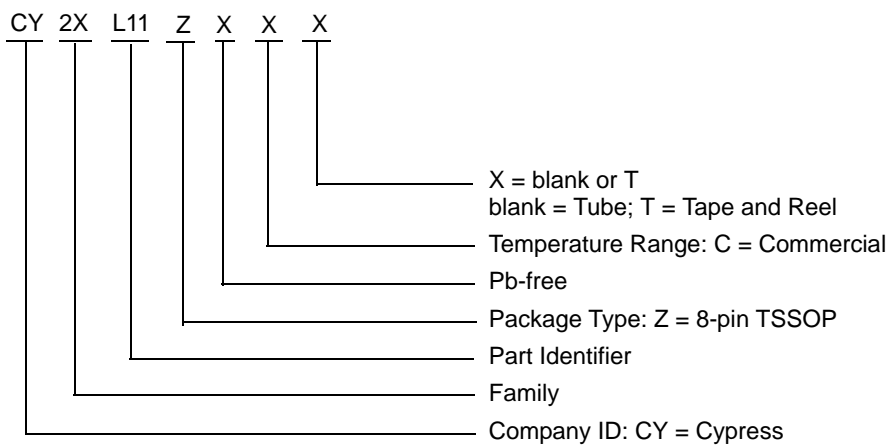




**Ordering Information**

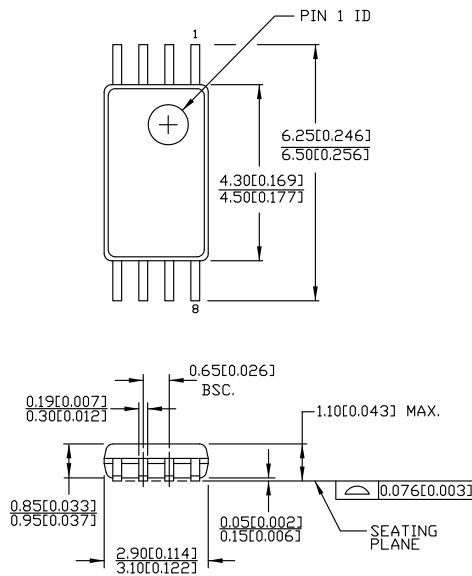
Part Number	Package Description	Product Flow
CY2XL11ZXC	8-pin TSSOP	Commercial, 0 °C to 70 °C
CY2XL11ZXCT	8-pin TSSOP – Tape and Reel	Commercial, 0 °C to 70 °C
CY2XL11ZXI	8-pin TSSOP	Industrial, –40 °C to +85 °C
CY2XL11ZXIT	8-pin TSSOP – Tape and Reel	Industrial, –40 °C to +85 °C

**Ordering Code Definitions**



## Package Drawing and Dimensions

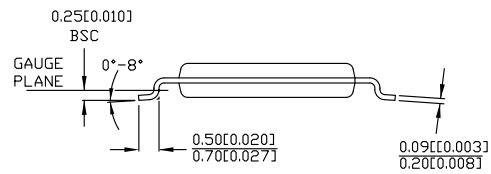
Figure 9. 8-pin TSSOP (4.40 mm Body) Package Outline, 51-85093



DIMENSIONS IN MM[INCHES] MIN.  
MAX.

REFERENCE JEDEC MO-153

PART #	
Z08.173	STANDARD PKG.
ZZ08.173	LEAD FREE PKG.



51-85093 \*E

## Acronyms

Acronym	Description
CLKOUT	Clock Output
CMOS	Complementary Metal Oxide Semiconductor
DPM	Die Pick Map
EPROM	Erasable Programmable Read Only Memory
LVDS	Low-Voltage Differential Signaling
NTSC	National Television System Committee
OE	Output Enable
PAL	Phase Alternate Line
PD	Power Down
PLL	Phase Locked Loop
TTL	Transistor-Transistor Logic

## Document Conventions

### Units of Measures

Symbol	Unit of Measure
°C	degree Celsius
kHz	kilohertz
kΩ	kilohm
MHz	megahertz
MΩ	megaohm
μA	microampere
μs	microsecond
μV	microvolt
μVrms	microvolts root-mean-square
mA	milliampere
mm	millimeter
ms	millisecond
mV	millivolt
nA	nanoampere
ns	nanosecond
nV	nanovolt
Ω	ohm
ppm	parts per million
v	volt

## Document History Page

Document Title: CY2XL11, 100 MHz LVDS Clock Generator Document Number: 001- 42886				
Rev.	ECN No.	Submission Date	Orig. of Change	Description of Change
**	2117527	See ECN	WWZ / KVM / AESA	New data sheet
*A	2669117	03/05/2009	KVM / AESA	Changed Data Sheet Status to Final Changed crystal and output frequency Removed MSL spec Changed IIL value from -20 uA to -50 uA Changed IIH value from 20 uA to 115 uA Changed phase jitter value from 1 to 0.53 ps Changed junction temp from 125°C to 135°C Changed IDD from 150 mA to 120 mA Rise / fall time changed to 350 ps to 500ps
*B	2700242	04/30/2009	KVM / PYRS	Typo correction Reformatted AC and DC tables Added IDD spec for 2.5V Added CINX and TLOCK specs Changed CIN from 7pF to 15pF
*C	2718433	06/12/2009	WWZ / HMT	No change. Submit to ECN for product launch.
*D	2764787	09/18/2009	KVM	Add clause to I <sub>OZ</sub> Test Conditions Change V <sub>OD</sub> limits from 250/450 mV to 247/454 mV Add max limit for T <sub>R</sub> , T <sub>F</sub> : 1.0 ns Change T <sub>OE</sub> max from 100 ns to 120 ns Change T <sub>LOCK</sub> max from 10 ms to 5 ms
*E	3067416	10/20/20	BASH	Added the industrial part in Ordering Information table. Added Ordering Code Definition.  Updated package diagram.  Added <a href="#">Acronyms and Units of Measures</a> .
*F	3199831	03/18/11	CXQ	No change. Sunset review spec.
*G	4334627	04/06/2014	CINM	Updated <a href="#">Package Drawing and Dimensions</a> : spec 51-85093 – Changed revision from *C to *D. Updated in new template. Completing Sunset Review.
*H	4582584	11/07/2014	CINM	Added related documentation hyperlink in page 1. Updated the part number CY2XL11ZXI(T) to CY2XL11ZXIT, in <a href="#">Ordering Information</a> . Updated <a href="#">Package Drawing and Dimensions</a> from 51-85093 *D to 51-85093 *E.
*I	5686604	04/06/2017	XHT	Updated to new template. Completing sunset review.

## Sales, Solutions, and Legal Information

### Worldwide Sales and Design Support

Cypress maintains a worldwide network of offices, solution centers, manufacturer's representatives, and distributors. To find the office closest to you, visit us at [Cypress Locations](#).

#### Products

ARM® Cortex® Microcontrollers	<a href="http://cypress.com/arm">cypress.com/arm</a>
Automotive	<a href="http://cypress.com/automotive">cypress.com/automotive</a>
Clocks & Buffers	<a href="http://cypress.com/clocks">cypress.com/clocks</a>
Interface	<a href="http://cypress.com/interface">cypress.com/interface</a>
Internet of Things	<a href="http://cypress.com/iot">cypress.com/iot</a>
Memory	<a href="http://cypress.com/memory">cypress.com/memory</a>
Microcontrollers	<a href="http://cypress.com/mcu">cypress.com/mcu</a>
PSoC	<a href="http://cypress.com/psoc">cypress.com/psoc</a>
Power Management ICs	<a href="http://cypress.com/pmic">cypress.com/pmic</a>
Touch Sensing	<a href="http://cypress.com/touch">cypress.com/touch</a>
USB Controllers	<a href="http://cypress.com/usb">cypress.com/usb</a>
Wireless Connectivity	<a href="http://cypress.com/wireless">cypress.com/wireless</a>

#### PSoC® Solutions

[PSoC 1](#) | [PSoC 3](#) | [PSoC 4](#) | [PSoC 5LP](#) | [PSoC 6](#)

#### Cypress Developer Community

[Forums](#) | [WICED IOT Forums](#) | [Projects](#) | [Video](#) | [Blogs](#) | [Training](#) | [Components](#)

#### Technical Support

[cypress.com/support](http://cypress.com/support)

#### Clock Tree Services

[cypress.com/cts](http://cypress.com/cts)

---

© Cypress Semiconductor Corporation, 2008-2017. This document is the property of Cypress Semiconductor Corporation and its subsidiaries, including Spansion LLC ("Cypress"). This document, including any software or firmware included or referenced in this document ("Software"), is owned by Cypress under the intellectual property laws and treaties of the United States and other countries worldwide. Cypress reserves all rights under such laws and treaties and does not, except as specifically stated in this paragraph, grant any license under its patents, copyrights, trademarks, or other intellectual property rights. If the Software is not accompanied by a license agreement and you do not otherwise have a written agreement with Cypress governing the use of the Software, then Cypress hereby grants you a personal, non-exclusive, nontransferable license (without the right to sublicense) (1) under its copyright rights in the Software (a) for Software provided in source code form, to modify and reproduce the Software solely for use with Cypress hardware products, only internally within your organization, and (b) to distribute the Software in binary code form externally to end users (either directly or indirectly through resellers and distributors), solely for use on Cypress hardware product units, and (2) under those claims of Cypress's patents that are infringed by the Software (as provided by Cypress, unmodified) to make, use, distribute, and import the Software solely for use with Cypress hardware products. Any other use, reproduction, modification, translation, or compilation of the Software is prohibited.

TO THE EXTENT PERMITTED BY APPLICABLE LAW, CYPRESS MAKES NO WARRANTY OF ANY KIND, EXPRESS OR IMPLIED, WITH REGARD TO THIS DOCUMENT OR ANY SOFTWARE OR ACCOMPANYING HARDWARE, INCLUDING, BUT NOT LIMITED TO, THE IMPLIED WARRANTIES OF MERCHANTABILITY AND FITNESS FOR A PARTICULAR PURPOSE. To the extent permitted by applicable law, Cypress reserves the right to make changes to this document without further notice. Cypress does not assume any liability arising out of the application or use of any product or circuit described in this document. Any information provided in this document, including any sample design information or programming code, is provided only for reference purposes. It is the responsibility of the user of this document to properly design, program, and test the functionality and safety of any application made of this information and any resulting product. Cypress products are not designed, intended, or authorized for use as critical components in systems designed or intended for the operation of weapons, weapons systems, nuclear installations, life-support devices or systems, other medical devices or systems (including resuscitation equipment and surgical implants), pollution control or hazardous substances management, or other uses where the failure of the device or system could cause personal injury, death, or property damage ("Unintended Uses"). A critical component is any component of a device or system whose failure to perform can be reasonably expected to cause the failure of the device or system, or to affect its safety or effectiveness. Cypress is not liable, in whole or in part, and you shall and hereby do release Cypress from any claim, damage, or other liability arising from or related to all Unintended Uses of Cypress products. You shall indemnify and hold Cypress harmless from and against all claims, costs, damages, and other liabilities, including claims for personal injury or death, arising from or related to any Unintended Uses of Cypress products.

Cypress, the Cypress logo, Spansion, the Spansion logo, and combinations thereof, WICED, PSoC, CapSense, EZ-USB, F-RAM, and Traveo are trademarks or registered trademarks of Cypress in the United States and other countries. For a more complete list of Cypress trademarks, visit [cypress.com](http://cypress.com). Other names and brands may be claimed as property of their respective owners.