

## Crystal to LVPECL Clock Generator

### Features

- One LVPECL output pair
- External crystal frequency: 25.0 MHz
- Selectable output frequency: 62.5 MHz or 75 MHz
- Low RMS phase jitter at 75 MHz, using 25 MHz crystal (1.5 MHz–10 MHz): 0.27 ps (typical)
- Low RMS phase jitter at 62.5 MHz, using 25 MHz crystal (1.5 MHz–10 MHz): 0.38 ps (typical)
- Pb-free 8-Pin TSSOP package
- Supply voltage: 3.3 V
- Commercial temperature range

### Functional Description

The CY2XP41 is a PLL (Phase Locked Loop) based high performance clock generator. It is optimized to generate high performance clock frequencies for DVD-R applications. It uses Cypress's low noise VCO technology to achieve less than 1 ps typical RMS phase jitter, that meets application jitter requirements. The CY2XP41 has a crystal oscillator interface input and one LVPECL output pair.

### Logic Block Diagram

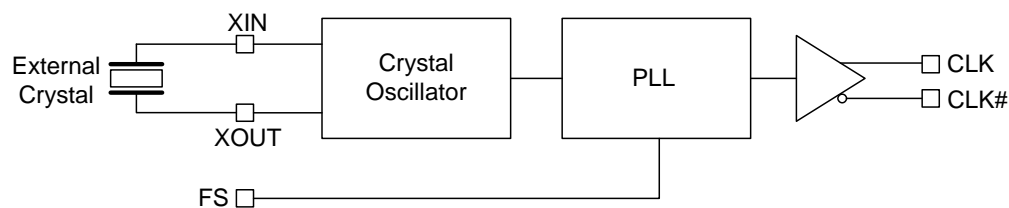

## Contents

<b>Pinouts</b> .....	<b>3</b>	Termination for LVPECL Output .....	7
<b>Absolute Maximum Conditions</b> .....	<b>4</b>	Crystal Interface .....	7
<b>Operating Conditions</b> .....	<b>4</b>	<b>Ordering Information</b> .....	<b>8</b>
<b>Electrical Characteristics for Input</b> .....	<b>4</b>	<b>Acronyms</b> .....	<b>9</b>
<b>DC Electrical Characteristics for Power Supplies</b> .....	<b>4</b>	<b>Document Conventions</b> .....	<b>9</b>
<b>Frequency Table</b> .....	<b>4</b>	<b>Document History Page</b> .....	<b>10</b>
<b>DC Electrical Characteristics for LVPECL Output</b> .....	<b>5</b>	<b>Sales, Solutions, and Legal Information</b> .....	<b>10</b>
<b>Crystal Characteristics</b> .....	<b>5</b>	Worldwide Sales and Design Support .....	10
<b>Measurement Definitions</b> .....	<b>6</b>	Products .....	10
<b>Application Information</b> .....	<b>7</b>	PSoC Solutions .....	10
Power Supply Filtering Techniques .....	7		

Pinouts

Figure 1. Pin Diagram – 8 Pin TSSOP

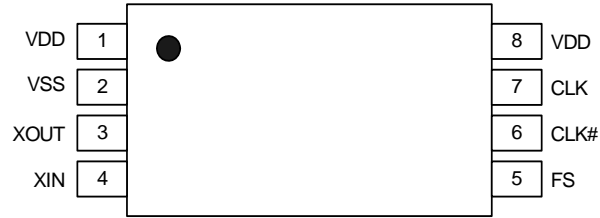

Table 1. Pin Definitions – 8 Pin TSSOP

Pin	Name	Type	Description
1, 8	VDD	Power	3.3 V power supply. All supply current flows through pin 1
2	VSS	Power	Ground
3, 4	XOUT, XIN	XTAL output and input	Parallel resonant crystal interface
5	FS	LVC MOS/LVTTL input	Frequency Select Input, See “Frequency Table” on page 4
6,7	CLK#, CLK	LVPECL output	Differential Clock Output

## Frequency Table

Input		Output Frequency (MHz)
Input Xtal Frequency (MHz)	FS	
25	0	62.5
25	1	75.0

## Absolute Maximum Conditions

Parameter	Description	Condition	Min	Max	Unit
V <sub>DD</sub>	Supply Voltage		-0.5	4.4	V
V <sub>IN</sub> <sup>[1.]</sup>	Input Voltage, DC	Relative to VSS	-0.5	V <sub>DD</sub> + 0.5	V
T <sub>S</sub>	Temperature, Storage	Non Functional	-65	150	°C
T <sub>J</sub>	Temperature, Junction		-	135	°C
ESD <sub>HBM</sub>	ESD Protection (Human Body Model)	JEDEC STD 22-A114-B	2000	-	V
UL-94	Flammability Rating	At 1/8 in.	V-0		
Θ <sub>JA</sub> <sup>[2]</sup>	Thermal Resistance, Junction to Ambient	0 m/s airflow	100		°C/W
		1 m/s airflow	91		
		2.5 m/s airflow	87		

## Operating Conditions

Parameter	Description	Min	Max	Unit
V <sub>DD</sub>	3.3 V Supply Voltage	3.135	3.465	V
T <sub>A</sub>	Ambient Temperature, Commercial	0	70	°C
T <sub>PU</sub>	Power up time for all V <sub>DD</sub> to reach minimum specified voltage (ensure power ramps are monotonic)	0.05	500	ms

## Electrical Characteristics for Input

Parameter	Description	Test Conditions	Min	Typ	Max	Unit
V <sub>IL</sub>	Input Low Voltage, FS		-	-	0.3*V <sub>DD</sub>	V
V <sub>IH</sub>	Input High Voltage, FS		0.7*V <sub>DD</sub>	-	-	V
I <sub>IL</sub>	Input Low Current, FS	FS = V <sub>SS</sub>	-50	-	-	μA
I <sub>IH</sub>	Input High Current, FS	FS = V <sub>DD</sub>	-	-	115	μA
C <sub>IN</sub> <sup>[3]</sup>	Input Capacitance, FS		-	15	-	pF
C <sub>INX</sub> <sup>[3]</sup>	Input Capacitance, XIN & XOUT		-	4.5	-	pF

## DC Electrical Characteristics for Power Supplies

Parameter	Description	Min	Typ	Max	Unit
I <sub>DD</sub>	Power Supply Current with output unterminated	-	-	125	mA
I <sub>DdT</sub>	Power Supply Current with output terminated	-	-	180	mA

### Note

1. The voltage on any input or IO pin cannot exceed the power pin during power up. Power supply sequencing is NOT required.
2. Simulated using Apache Sentinel TI software. The board is derived from the JEDEC multilayer standard. It measures 76 x 114 x 1.6 mm and has 4-layers of copper (2/1/1/2 oz.). The internal layers are 100% copper planes, while the top and bottom layers have 50% metallization. No vias are included in the model.
3. Not 100% tested, guaranteed by design and characterization.

## DC Electrical Characteristics for LVPECL Output

Parameter	Description	Min	Typ	Max	Unit
V <sub>CM</sub>	Common-Mode Voltage (CLK + CLK#) / 2, defined in <a href="#">Figure 5</a> on page 6, using <a href="#">Figure 2</a> on page 6 circuit.	175	–	2000	mV
V <sub>PP</sub>	Differential Peak Output Voltage, defined in <a href="#">Figure 5</a> on page 6, using <a href="#">Figure 2</a> on page 6 circuit.	350	780	850	mV

## Crystal Characteristics

Parameter	Description	Min	Typ	Max	Unit
	Mode of Oscillation	Fundamental			
F	Frequency	–	25	–	MHz
ESR	Equivalent Series Resistance	–	–	50	Ω
C <sub>L</sub>	Crystal Load Capacitance	–	10	–	pF
C <sub>S</sub>	Shunt Capacitance	–	–	7	pF
DL	Crystal Drive Level	–	–	300	μW

## AC Characteristics<sup>[3]</sup>

Parameter	Description	Test Conditions	Min	Typ	Max	Unit
F <sub>OUT</sub>	Output Frequency		62.5	–	75.0	MHz
T <sub>R</sub> , T <sub>F</sub>	Output Rise/Fall time	Defined in <a href="#">Figure 5</a> on page 6	–	0.35	1.0	ns
T <sub>Jitter(φ)</sub>	RMS Phase Jitter (Random)	75 MHz, (1.5 MHz - 10 MHz filter), 3.3 V	–	0.27	–	ps
		62.5 MHz, (1.5 MHz - 10 MHz filter), 3.3 V	–	0.38	–	ps
T <sub>DC</sub>	Duty Cycle	Defined in <a href="#">Figure 4</a> on page 6	45	–	55	%
T <sub>LOCK</sub>	Startup Time	Time for CLK to reach valid frequency measured from the time V <sub>DD</sub> = V <sub>DD(min.)</sub>	–	–	5	ms
T <sub>LFS</sub>	Re-lock Time	Time for CLK to reach valid frequency from FS pin change	–	–	1	ms

## Measurement Definitions

Figure 2. Output Load AC Test Circuit

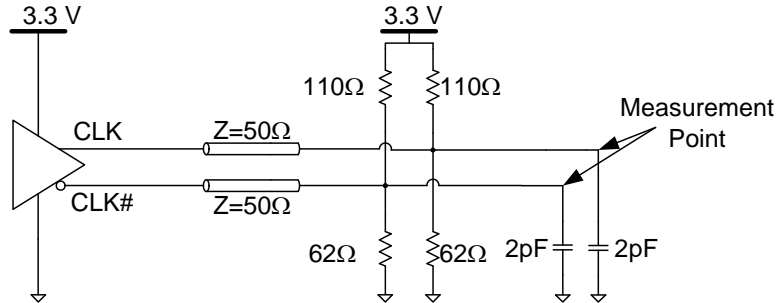

Figure 3. RMS Phase Jitter

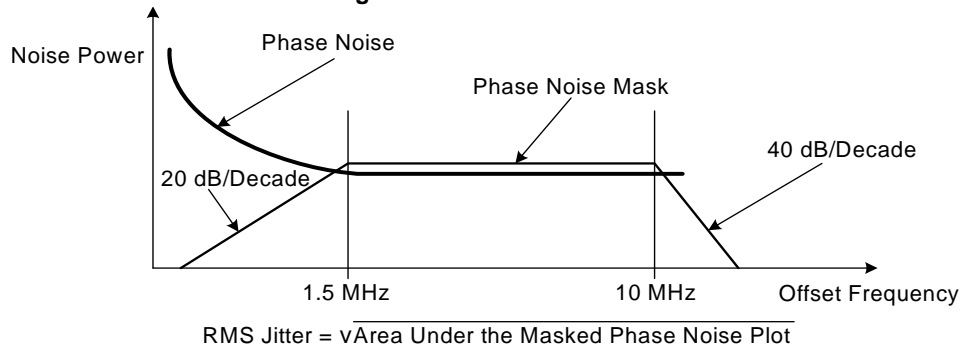

Figure 4. Output Duty Cycle

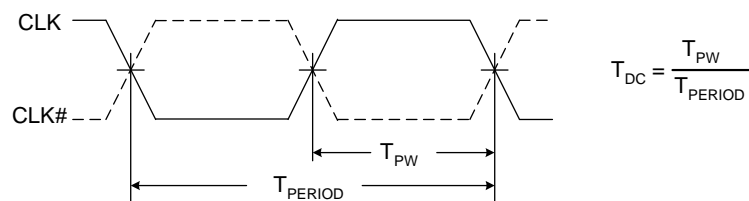
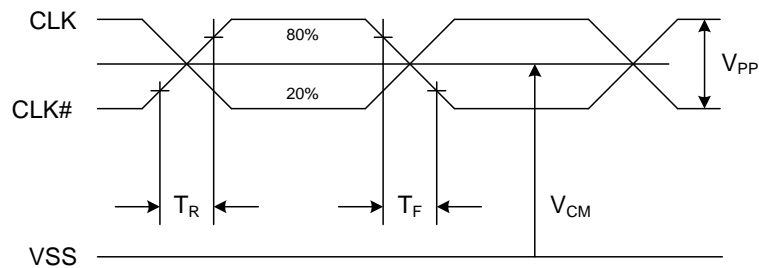

Figure 5. Output Rise and Fall Time and Peak-Peak Voltage Swing



## Application Information

### Power Supply Filtering Techniques

As in any high speed analog circuitry, noise at the power supply pins degrades performance. To achieve optimum jitter performance, use good power supply isolation practices. Figure 6 shows a typical filtering scheme. Since all of the current flows through pin 1, the resistance and inductance between this pin and the supply is minimized. A 0.01 or 0.1  $\mu\text{F}$  ceramic chip capacitor is also located close to this pin to provide a short and low impedance AC path to ground. A 1 to 10  $\mu\text{F}$  ceramic or tantalum capacitor should be located in the vicinity of this device, and may be shared with other devices.

Figure 6. Power Supply Filtering

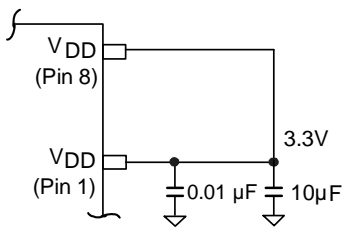

### Termination for LVPECL Output

The CY2XP41 implements its LVPECL driver with a current steering design. For proper operation, it requires resistor termination. This datasheet specifies a termination voltage of  $V_{DD}-2.1$  V. Impedance matching is advised for best signal integrity. Figure 2 on page 6 shows a termination scheme that is recommended as a guideline. Other suitable clock layouts exist and it is recommended that the board designers simulate to guarantee compatibility across all printed circuit and process variations. The recommended termination is a  $40\Omega$  load, which is used to achieve the specified common mode and peak-to-peak voltage swing. For optimal signal integrity, traces should also be  $40\Omega$ . The device will also operate with  $50\Omega$  termination, but is not specified with such a load.

### Crystal Interface

The CY2XP41 is characterized with 10 pF parallel resonant crystals. The capacitor values shown in Figure 7 are determined using a 25 MHz 10 pF parallel resonant crystal and are chosen to minimize the ppm error. Cypress recommends the following C1 and C2 values:  $C1 = C2 = 6.8$  pF.

Figure 7. Crystal Input Interface

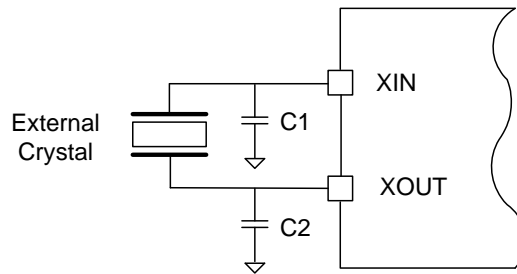





## Package Drawing and Dimensions

Figure 8. 8-Pin Thin Shrunken Small Outline Package (4.40mm Body) Z8

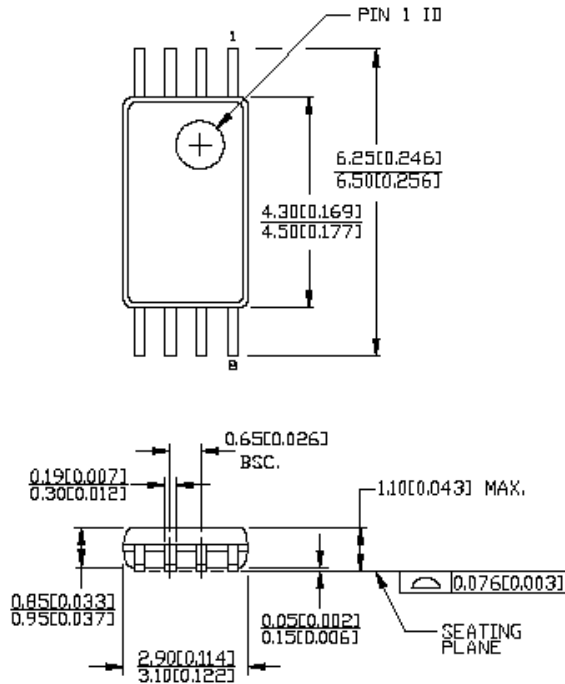

DIMENSIONS IN MM [INCHES] MIN. MAX.

REFERENCE JEDEC MO-153

PART #	
Z08.173	STANDARD PKG.
ZZ08.173	LEAD FREE PKG.

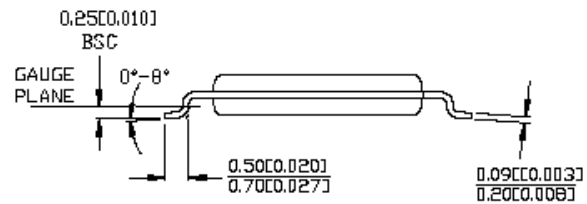

51-85093-°C

## Acronyms

Acronym	Description
ESD	electrostatic discharge
FAE	field application engineer
HBM	human body model
JEDEC	joint electron devices engineering council
LCC	leadless chip carrier
LVDS	Low-voltage differential signaling
OE	output enable
PCB	printed circuit board
PLL	phase-locked loop
RMS	root mean square
XO	crystal oscillator
OTP	one-time programmable

## Document Conventions

### Units of Measure

Symbol	Unit of Measure
°C	degrees Celsius
mA	milliampere
mV	millivolts
MHz	megahertz
ms	millisecond
ns	nanoseconds
pF	picofarads
µA	microamperes
ppm	parts per million
ps	picoseconds
V	volts
Ω	ohms
W	watts

## Document History Page

Document Title: CY2XP41 Crystal to LVPECL Clock Generator Document Number: 001-48923				
Revision	ECN	Submission Date	Orig. of Change	Description of Change
**	2669117	03/05/09	XHT/CXQ/ KVM	New data sheet
*A	2718433	06/12/09	WWZ/HMT	No change. Submit to ECN for product launch.
*B	2767298	09/22/09	KVM	Add I <sub>DD</sub> spec for unterminated outputs Change parameter name for I <sub>DD</sub> (terminated outputs) from I <sub>DD</sub> to I <sub>DDT</sub> Remove I <sub>DD</sub> footnote about externally dissipated current Add footnote: not 100% tested; plus corresponding references Add new parameter: C <sub>INX</sub> Add max limit for T <sub>R</sub> , T <sub>F</sub> : 1.0 ns Add new parameters: T <sub>LOCK</sub> and T <sub>LFS</sub> Edits to the Application Information text
*C	3196237	03/14/11	BASH	Template updates. Included ordering code definitions, acronyms, and units of measure. Updated package diagram from *A to *C.

## Sales, Solutions, and Legal Information

### Worldwide Sales and Design Support

Cypress maintains a worldwide network of offices, solution centers, manufacturer’s representatives, and distributors. To find the office closest to you, visit us at [Cypress Locations](#).

### Products

Automotive	<a href="http://cypress.com/go/automotive">cypress.com/go/automotive</a>
Clocks & Buffers	<a href="http://cypress.com/go/clocks">cypress.com/go/clocks</a>
Interface	<a href="http://cypress.com/go/interface">cypress.com/go/interface</a>
Lighting & Power Control	<a href="http://cypress.com/go/powerpsoc">cypress.com/go/powerpsoc</a> <a href="http://cypress.com/go/plc">cypress.com/go/plc</a>
Memory	<a href="http://cypress.com/go/memory">cypress.com/go/memory</a>
Optical & Image Sensing	<a href="http://cypress.com/go/image">cypress.com/go/image</a>
PSoC	<a href="http://cypress.com/go/psoc">cypress.com/go/psoc</a>
Touch Sensing	<a href="http://cypress.com/go/touch">cypress.com/go/touch</a>
USB Controllers	<a href="http://cypress.com/go/USB">cypress.com/go/USB</a>
Wireless/RF	<a href="http://cypress.com/go/wireless">cypress.com/go/wireless</a>

### PSoC Solutions

[psoc.cypress.com/solutions](http://psoc.cypress.com/solutions)  
PSoC 1 | PSoC 3 | PSoC 5

© Cypress Semiconductor Corporation, 2009-2011. The information contained herein is subject to change without notice. Cypress Semiconductor Corporation assumes no responsibility for the use of any circuitry other than circuitry embodied in a Cypress product. Nor does it convey or imply any license under patent or other rights. Cypress products are not warranted nor intended to be used for medical, life support, life saving, critical control or safety applications, unless pursuant to an express written agreement with Cypress. Furthermore, Cypress does not authorize its products for use as critical components in life-support systems where a malfunction or failure may reasonably be expected to result in significant injury to the user. The inclusion of Cypress products in life-support systems application implies that the manufacturer assumes all risk of such use and in doing so indemnifies Cypress against all charges.

Any Source Code (software and/or firmware) is owned by Cypress Semiconductor Corporation (Cypress) and is protected by and subject to worldwide patent protection (United States and foreign), United States copyright laws and international treaty provisions. Cypress hereby grants to licensee a personal, non-exclusive, non-transferable license to copy, use, modify, create derivative works of, and compile the Cypress Source Code and derivative works for the sole purpose of creating custom software and or firmware in support of licensee product to be used only in conjunction with a Cypress integrated circuit as specified in the applicable agreement. Any reproduction, modification, translation, compilation, or representation of this Source Code except as specified above is prohibited without the express written permission of Cypress.

Disclaimer: CYPRESS MAKES NO WARRANTY OF ANY KIND, EXPRESS OR IMPLIED, WITH REGARD TO THIS MATERIAL, INCLUDING, BUT NOT LIMITED TO, THE IMPLIED WARRANTIES OF MERCHANTABILITY AND FITNESS FOR A PARTICULAR PURPOSE. Cypress reserves the right to make changes without further notice to the materials described herein. Cypress does not assume any liability arising out of the application or use of any product or circuit described herein. Cypress does not authorize its products for use as critical components in life-support systems where a malfunction or failure may reasonably be expected to result in significant injury to the user. The inclusion of Cypress’ product in a life-support systems application implies that the manufacturer assumes all risk of such use and in doing so indemnifies Cypress against all charges.

Use may be limited by and subject to the applicable Cypress software license agreement.