

512K x 16 Static RAM

Features

- High speed
 - 55 ns and 70 ns availability
- Voltage range:
 - CY62157CV25: 2.2V–2.7V
 - CY62157CV30: 2.7V–3.3V
 - CY62157CV33: 3.0V–3.6V
- Ultra-low active power
 - Typical active current: 1.5 mA @ f = 1 MHz
 - Typical active current: 5.5 mA @ f = f_{max} (70 ns speed)
- Low standby power
- Easy memory expansion with \overline{CE}_1 , \overline{CE}_2 and \overline{OE} features
- Automatic power-down when deselected
- CMOS for optimum speed/power

Functional Description

The CY62157CV25/30/33 are high-performance CMOS static RAMs organized as 512K words by 16 bits. These devices feature advanced circuit design to provide ultra-low active current. This is ideal for providing More Battery Life™ (MoBL™) in portable applications such as cellular telephones. The devices also have an automatic power-down feature that significantly reduces power consumption by 80% when addresses are not toggling. The device can also be put into standby mode

reducing power consumption by more than 99% when deselected (\overline{CE}_1 HIGH or \overline{CE}_2 LOW or both \overline{BLE} and \overline{BHE} are HIGH). The input/output pins (I/O_0 through I/O_{15}) are placed in a high-impedance state when: deselected (\overline{CE}_1 HIGH or \overline{CE}_2 LOW), outputs are disabled (\overline{OE} HIGH), both Byte High Enable and Byte Low Enable are disabled (\overline{BHE} , \overline{BLE} HIGH), or during a write operation (\overline{CE}_1 LOW and \overline{CE}_2 HIGH and \overline{WE} LOW).

Writing to the device is accomplished by taking Chip Enable 1 (\overline{CE}_1) and Write Enable (\overline{WE}) inputs LOW and Chip Enable 2 (\overline{CE}_2) HIGH. If Byte Low Enable (\overline{BLE}) is LOW, then data from I/O pins (I/O_0 through I/O_7), is written into the location specified on the address pins (A_0 through A_{18}). If Byte High Enable (\overline{BHE}) is LOW, then data from I/O pins (I/O_8 through I/O_{15}) is written into the location specified on the address pins (A_0 through A_{18}).

Reading from the device is accomplished by taking Chip Enable 1 (\overline{CE}_1) and Output Enable (\overline{OE}) LOW and Chip Enable 2 (\overline{CE}_2) HIGH while forcing the Write Enable (\overline{WE}) HIGH. If Byte Low Enable (\overline{BLE}) is LOW, then data from the memory location specified by the address pins will appear on I/O_0 to I/O_7 . If Byte High Enable (\overline{BHE}) is LOW, then data from memory will appear on I/O_8 to I/O_{15} . See the truth table at the back of this data sheet for a complete description of read and write modes.

The CY62157CV25/30/33 are available in a 48-ball FBGA package.

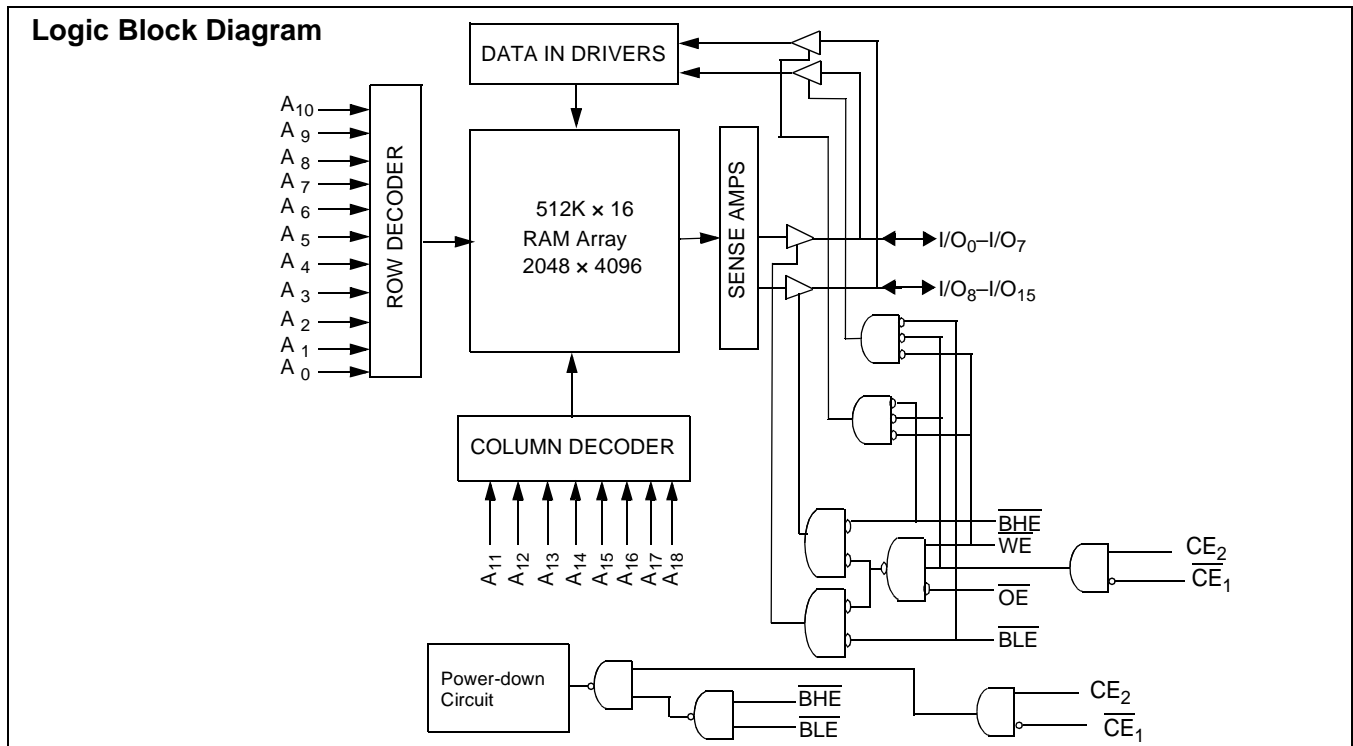

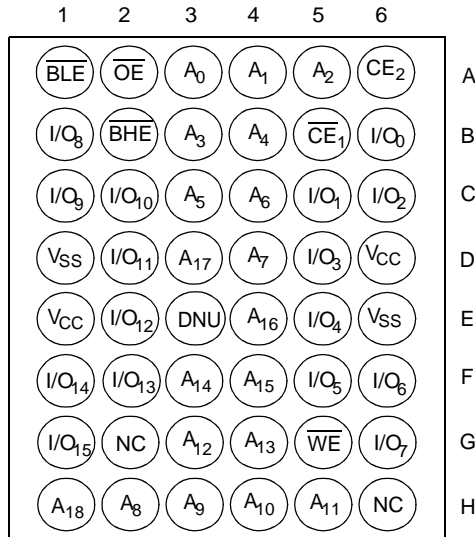
Pin Configurations^[1, 2]
FBGA (Top View)

Maximum Ratings

(Above which the useful life may be impaired. For user guidelines, not tested.)

Storage Temperature -65°C to +150°C

Ambient Temperature with Power Applied -55°C to +125°C

Supply Voltage to Ground Potential ... -0.5V to V_{CCmax} + 0.5V

DC Voltage Applied to Outputs in High-Z State^[3] -0.5V to V_{CC} + 0.3V

DC Input Voltage^[3] -0.5V to V_{CC} + 0.3V

Output Current into Outputs (LOW) 20 mA

Static Discharge Voltage > 2001V
(per MIL-STD-883, Method 3015)

Latch-up Current > 200 mA

Operating Range

Device	Range	Ambient Temperature	V _{CC}
CY62157CV25	Industrial	-40°C to +85°C	2.2V to 2.7V
CY62157CV30			2.7V to 3.3V
CY62157CV33			3.0V to 3.6V

Product Portfolio

Product	V _{CC} Range			Speed	Power Dissipation (Industrial)					
					Operating (I _{CC})				Standby (I _{SB2})	
	V _{CC(min.)}	V _{CC(typ.)} ^[4]	V _{CC(max.)}		f = 1 MHz		f = f _{max}		Standby (I _{SB2})	
			Typ. ^[4]	Max.	Typ. ^[4]	Max.	Typ. ^[4]	Max.		
CY62157CV25	2.2V	2.5V	2.7V	55 ns	1.5 mA	3 mA	7 mA	15 mA	6 μA	25 μA
				70 ns	1.5 mA	3 mA	5.5 mA	12 mA		
CY62157CV30	2.7V	3.0V	3.3V	55 ns	1.5 mA	3 mA	7 mA	15 mA	8 μA	25 μA
				70 ns	1.5 mA	3 mA	5.5 mA	12 mA		
CY62157CV33	3.0V	3.3V	3.6V	55 ns	1.5 mA	3 mA	7 mA	15 mA	10 μA	30 μA
				70 ns	1.5 mA	3 mA	5.5 mA	12 mA		

Notes:

1. NC pins are not connected to the die.
2. E3 (DNU) can be left as NC or V_{SS} to ensure proper application.
3. V_{IL(min.)} = -2.0V for pulse durations less than 20 ns.
4. Typical values are included for reference only and are not guaranteed or tested. Typical values are measured at V_{CC} = V_{CC(typ.)}, T_A = 25°C.

Electrical Characteristics Over the Operating Range

Parameter	Description	Test Conditions		CY62157CV25-55			CY62157CV25-70			Unit
				Min.	Typ. ^[4]	Max.	Min.	Typ. ^[4]	Max.	
V _{OH}	Output HIGH Voltage	I _{OH} = -0.1 mA	V _{CC} = 2.2V	2.0			2.0			V
V _{OL}	Output LOW Voltage	I _{OL} = 0.1 mA	V _{CC} = 2.2V			0.4			0.4	V
V _{IH}	Input HIGH Voltage			1.8		V _{CC} + 0.3V	1.8		V _{CC} + 0.3V	V
V _{IL}	Input LOW Voltage			-0.3		0.6	-0.3		0.6	V
I _{IX}	Input Leakage Current	GND ≤ V _I ≤ V _{CC}		-1		+1	-1		+1	μA
I _{OZ}	Output Leakage Current	GND ≤ V _O ≤ V _{CC} , Output Disabled		-1		+1	-1		+1	μA
I _{CC}	V _{CC} Operating Supply Current	f = f _{MAX} = 1/t _{RC}	V _{CC} = 2.7V I _{OUT} = 0 mA CMOS Levels		7	15		5.5	12	mA
		f = 1 MHz			1.5	3		1.5	3	
I _{SB1}	Automatic CE Power-Down Current—CMOS Inputs	$\overline{CE}_1 \geq V_{CC} - 0.2V$ or $CE_2 \leq 0.2V$ $V_{IN} \geq V_{CC} - 0.2V$ or $V_{IN} \leq 0.2V$, $f = f_{max}$ (Address and Data Only), $f = 0$ (OE, WE, BHE and BLE)			6	25		6	25	μA
I _{SB2}	Automatic CE Power-Down Current—CMOS Inputs	$\overline{CE}_1 \geq V_{CC} - 0.2V$ or $CE_2 \leq 0.2V$ $V_{IN} \geq V_{CC} - 0.2V$ or $V_{IN} \leq 0.2V$, $f = 0$, V _{CC} = 2.7V								

Parameter	Description	Test Conditions		CY62157CV30-55			CY62157CV30-70			Unit
				Min.	Typ. ^[4]	Max.	Min.	Typ. ^[4]	Max.	
V _{OH}	Output HIGH Voltage	I _{OH} = -1.0 mA	V _{CC} = 2.7V	2.4			2.4			V
V _{OL}	Output LOW Voltage	I _{OL} = 2.1 mA	V _{CC} = 2.7V			0.4			0.4	V
V _{IH}	Input HIGH Voltage			2.2		V _{CC} + 0.3V	2.2		V _{CC} + 0.3V	V
V _{IL}	Input LOW Voltage			-0.3		0.8	-0.3		0.8	V
I _{IX}	Input Leakage Current	GND ≤ V _I ≤ V _{CC}		-1		+1	-1		+1	μA
I _{OZ}	Output Leakage Current	GND ≤ V _O ≤ V _{CC} , Output Disabled		-1		+1	-1		+1	μA
I _{CC}	V _{CC} Operating Supply Current	f = f _{MAX} = 1/t _{RC}	V _{CC} = 3.3V I _{OUT} = 0 mA CMOS Levels		7	15		5.5	12	mA
		f = 1 MHz			1.5	3		1.5	3	
I _{SB1}	Automatic CE Power-Down Current—CMOS Inputs	$\overline{CE}_1 \geq V_{CC} - 0.2V$ or $CE_2 \leq 0.2V$ $V_{IN} \geq V_{CC} - 0.2V$ or $V_{IN} \leq 0.2V$, $f = f_{max}$ (Address and Data Only), $f = 0$ (OE, WE, BHE and BLE)			8	25		8	25	μA
I _{SB2}	Automatic CE Power-Down Current—CMOS Inputs	$\overline{CE}_1 \geq V_{CC} - 0.2V$ or $CE_2 \leq 0.2V$ $V_{IN} \geq V_{CC} - 0.2V$ or $V_{IN} \leq 0.2V$, $f = 0$, V _{CC} = 3.3V								

Parameter	Description	Test Conditions		CY62157CV33-55			CY62157CV33-70			Unit
				Min.	Typ. ^[4]	Max.	Min.	Typ. ^[4]	Max.	
V _{OH}	Output HIGH Voltage	I _{OH} = -1.0 mA	V _{CC} = 3.0V	2.4			2.4			V
V _{OL}	Output LOW Voltage	I _{OL} = 2.1 mA	V _{CC} = 3.0V			0.4			0.4	V
V _{IH}	Input HIGH Voltage			2.2		V _{CC} + 0.3V	2.2		V _{CC} + 0.3V	V
V _{IL}	Input LOW Voltage			-0.3		0.8	-0.3		0.8	V
I _{IX}	Input Leakage Current	GND ≤ V _I ≤ V _{CC}		-1		+1	-1		+1	μA
I _{OZ}	Output Leakage Current	GND ≤ V _O ≤ V _{CC} , Output Disabled		-1		+1	-1		+1	μA
I _{CC}	V _{CC} Operating Supply Current	f = f _{MAX} = 1/t _{RC}	V _{CC} = 3.6V I _O = 0 mA CMOS Levels		7	15		5.5	12	mA
		f = 1 MHz			1.5	3		1.5	3	
I _{SB1}	Automatic CE Power-Down Current—CMOS Inputs	CE ₁ ≥ V _{CC} - 0.2V or CE ₂ ≤ 0.2V V _{IN} ≥ V _{CC} - 0.2V or V _{IN} ≤ 0.2V, f = f _{max} (Address and Data Only), f = 0 (OE, WE, BHE, and BLE)			10	30		10	30	μA
I _{SB2}	Automatic CE Power-Down Current—CMOS Inputs	CE ₁ ≥ V _{CC} - 0.2V or CE ₂ ≤ 0.2V V _{IN} ≥ V _{CC} - 0.2V or V _{IN} ≤ 0.2V, f = 0, V _{CC} = 3.6V								

Capacitance^[5]

Parameter	Description	Test Conditions	Max.	Unit
C _{IN}	Input Capacitance	T _A = 25°C, f = 1 MHz, V _{CC} = V _{CC} (typ.)	6	pF
C _{OUT}	Output Capacitance		8	pF

Thermal Resistance

Description	Test Conditions	Symbol	BGA	Unit
Thermal Resistance (Junction to Ambient) ^[5]	Still Air, soldered on a 3 x 4.5 inch, two-layer printed circuit board	θ _{JA}	55	°C/W
Thermal Resistance (Junction to Case) ^[5]		θ _{JC}	16	°C/W

Note:

5. Tested initially and after any design or process changes that may affect these parameters.

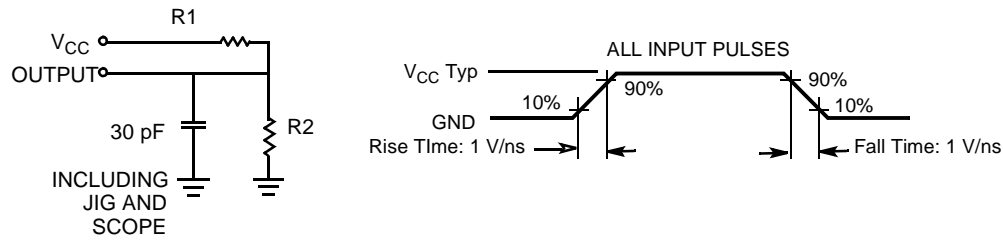
AC Test Loads and Waveforms

Equivalent to: THÉVENIN EQUIVALENT

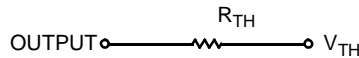

Parameters	2.5V	3.0V	3.3V	Unit
R1	16.6	1.105	1.216	K Ohms
R2	15.4	1.550	1.374	K Ohms
R _{TH}	8.0	0.645	0.645	K Ohms
V _{TH}	1.20	1.75	1.75	Volts

Data Retention Characteristics (Over the Operating Range)

Parameter	Description	Conditions	Min.	Typ. ^[4]	Max.	Unit
V _{DR}	V _{CC} for Data Retention		1.5		V _{CCmax}	V
I _{CCDR}	Data Retention Current	V _{CC} = 1.5V CE ₁ ≥ V _{CC} - 0.2V or CE ₂ ≤ 0.2V, V _{IN} ≥ V _{CC} - 0.2V or V _{IN} ≤ 0.2V		4	20	μA
t _{CDR} ^[5]	Chip Deselect to Data Retention Time		0			ns
t _R ^[6]	Operation Recovery Time		t _{RC}			ns

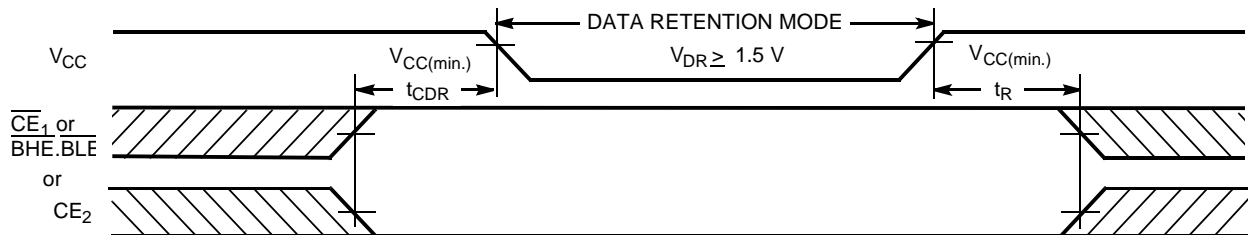
Data Retention Waveform^[7]

Note:

- Full Device AC operation requires linear V_{CC} ramp from V_{DR} to V_{CC(min.)} > 100 μs or stable at V_{CC(min.)} > 100 μs.
- BHE.BLE is the AND of both BHE and BLE. Chip can be deselected by either disabling the chip enable signals or by disabling both BHE and BLE.

Switching Characteristics Over the Operating Range^[8]

Parameter	Description	55 ns		70 ns		Unit
		Min.	Max.	Min.	Max.	
Read Cycle						
t_{RC}	Read Cycle Time	55		70		ns
t_{AA}	Address to Data Valid		55		70	ns
t_{OHA}	Data Hold from Address Change	10		10		ns
t_{ACE}	\overline{CE}_1 LOW and CE_2 HIGH to Data Valid		55		70	ns
t_{DOE}	\overline{OE} LOW to Data Valid		25		35	ns
t_{LZOE}	\overline{OE} LOW to Low-Z ^[9]	5		5		ns
t_{HZOE}	\overline{OE} HIGH to High-Z ^[9, 10]		20		25	ns
t_{LZCE}	\overline{CE}_1 LOW and CE_2 HIGH to Low-Z ^[9]	10		10		ns
t_{HZCE}	\overline{CE}_1 HIGH or CE_2 LOW to High-Z ^[9, 10]		20		25	ns
t_{PU}	\overline{CE}_1 LOW and CE_2 HIGH to Power-up	0		0		ns
t_{PD}	\overline{CE}_1 HIGH or CE_2 LOW to Power-down		55		70	ns
t_{DBE}	$\overline{BHE}/\overline{BLE}$ LOW to Data Valid		55		70	ns
$t_{LZBE}^{[11]}$	$\overline{BHE}/\overline{BLE}$ LOW to Low-Z ^[9]	5		5		ns
t_{HZBE}	$\overline{BHE}/\overline{BLE}$ HIGH to High-Z ^[9, 10]		20		25	ns
Write Cycle^[12]						
t_{WC}	Write Cycle Time	55		70		ns
t_{SCE}	\overline{CE}_1 LOW and CE_2 HIGH to Write End	45		60		ns
t_{AW}	Address Set-up to Write End	45		60		ns
t_{HA}	Address Hold from Write End	0		0		ns
t_{SA}	Address Set-up to Write Start	0		0		ns
t_{PWE}	\overline{WE} Pulse Width	45		50		ns
t_{BW}	$\overline{BHE}/\overline{BLE}$ Pulse Width	50		60		ns
t_{SD}	Data Set-up to Write End	25		30		ns
t_{HD}	Data Hold from Write End	0		0		ns
t_{HZWE}	\overline{WE} LOW to High-Z ^[9, 10]		20		25	ns
t_{LZWE}	\overline{WE} HIGH to Low-Z ^[9]	5		5		ns

Notes:

8. Test conditions assume signal transition time of 5 ns or less, timing reference levels of $V_{CC(typ.)}/2$, input pulse levels of 0 to $V_{CC(typ.)}$, and output loading of the specified I_{OL}/I_{OH} and 30-pF load capacitance.
9. At any given temperature and voltage condition, t_{HZCE} is less than t_{LZCE} , t_{HZBE} is less than t_{LZBE} , t_{HZOE} is less than t_{LZOE} , and t_{HZWE} is less than t_{LZWE} for any given device.
10. t_{HZOE} , t_{HZCE} , t_{HZBE} , and t_{HZWE} transitions are measured when the outputs enter a high-impedance state.
11. When both byte enables are toggled together this value is 10 ns.
12. The internal Write time of the memory is defined by the overlap of \overline{WE} , $\overline{CE}_1 = V_{IL}$, \overline{BHE} and/or $\overline{BLE} = V_{IL}$, $CE_2 = V_{IH}$. All signals must be ACTIVE to initiate a Write and any of these signals can terminate a Write by going INACTIVE. The data input set-up and hold timing should be referenced to the edge of the signal that terminates the Write.

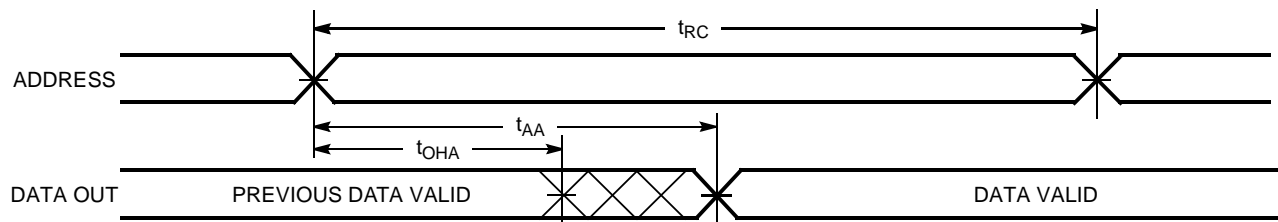
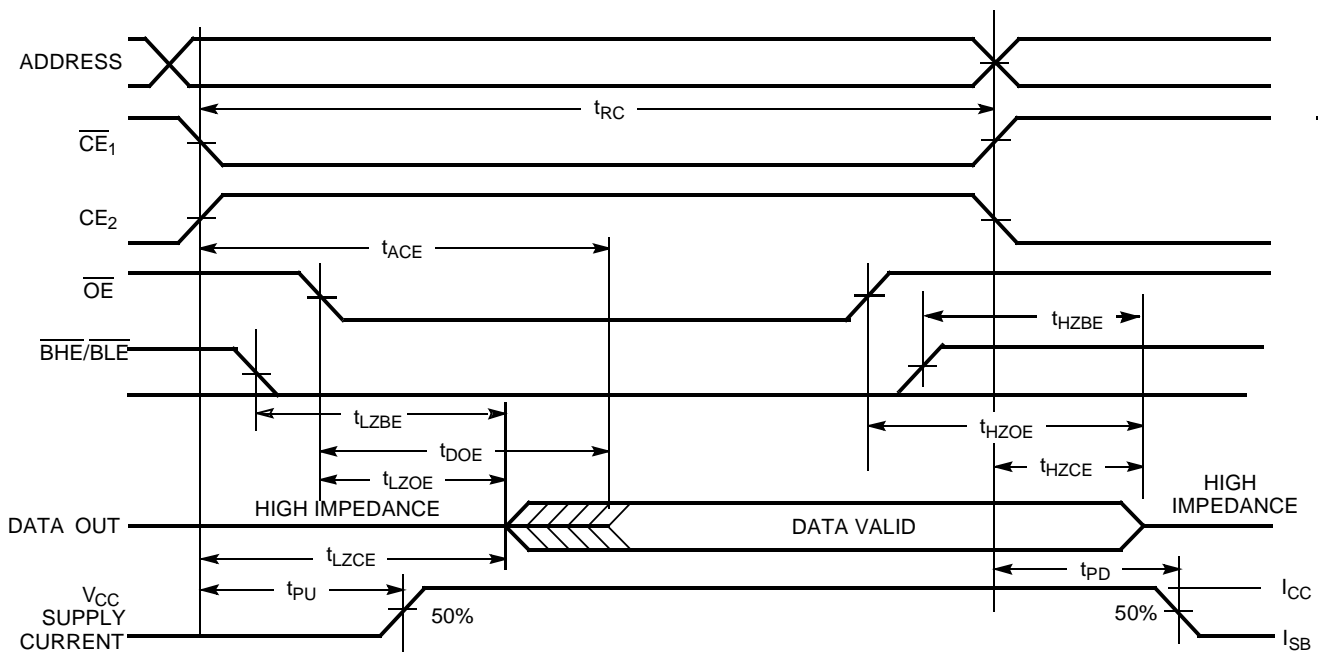
Switching Waveforms
Read Cycle No. 1 (Address Transition Controlled)^[13, 14]

Read Cycle No. 2 (\overline{OE} Controlled)^[14, 15]

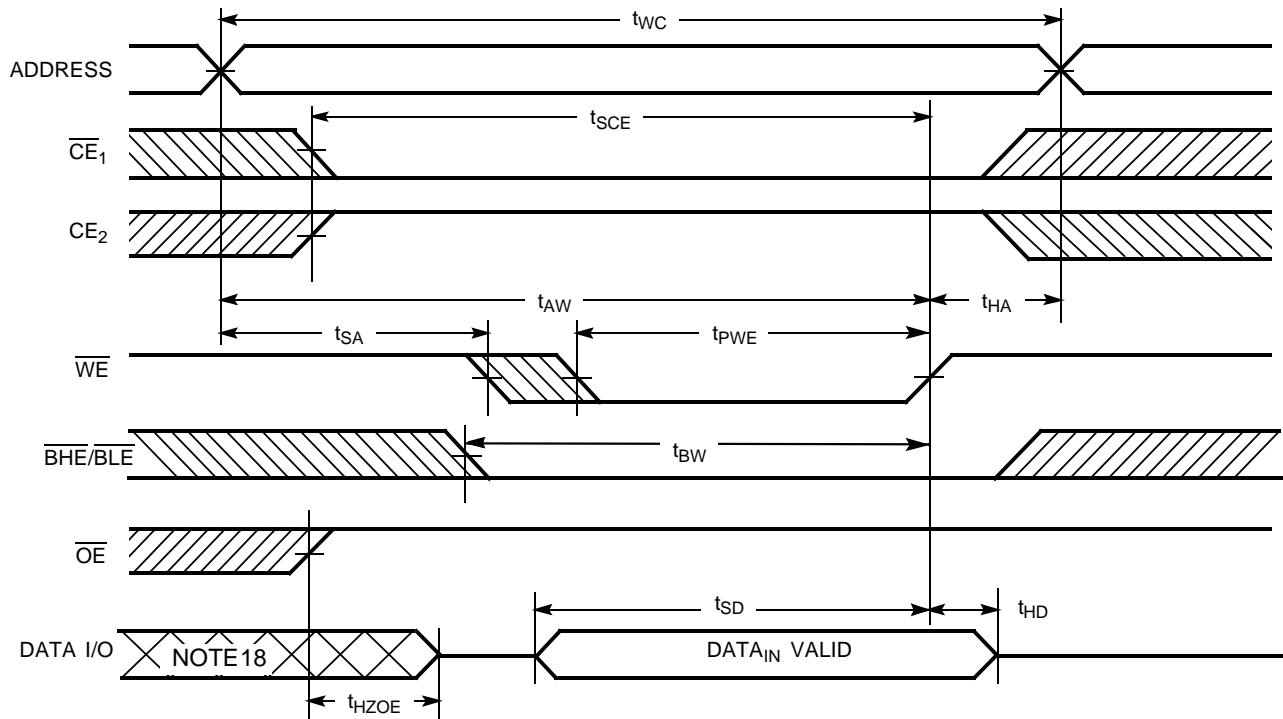
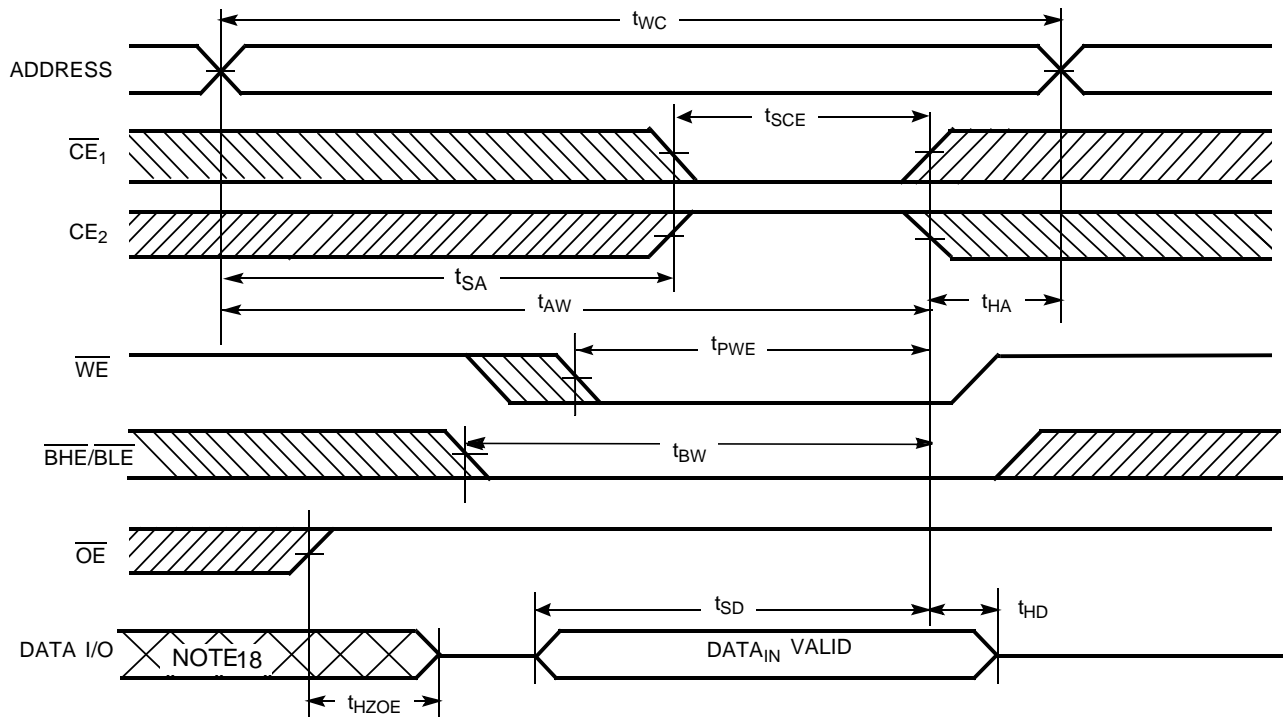
Notes:

13. Device is continuously selected. \overline{OE} , $\overline{CE}_1 = V_{IL}$, \overline{BHE} and/or $\overline{BLE} = V_{IL}$, $CE_2 = V_{IH}$.
14. \overline{WE} is HIGH for Read cycle.
15. Address valid prior to or coincident with \overline{CE}_1 , \overline{BHE} , \overline{BLE} transition LOW and CE_2 transition HIGH.

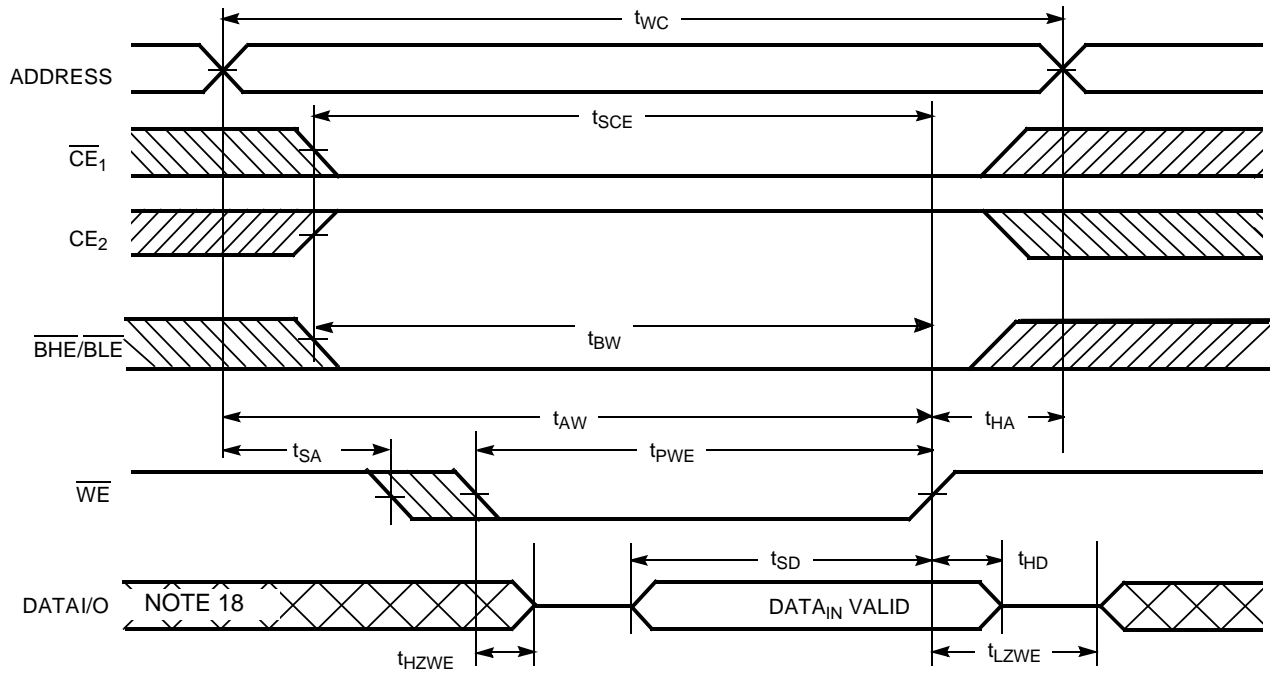
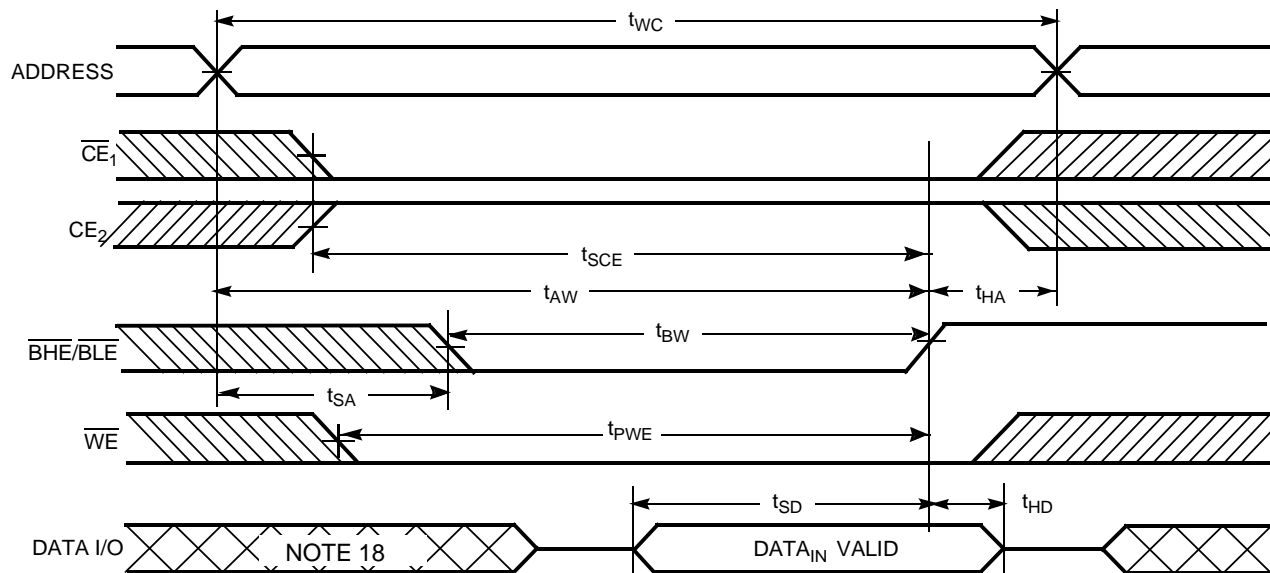
Switching Waveforms (continued)
Write Cycle No. 1 (\overline{WE} Controlled) [12, 16, 17]

Write Cycle No. 2 (\overline{CE}_1 or \overline{CE}_2 Controlled) [12, 16, 17]

Notes:

16. Data I/O is high-impedance if $\overline{OE} = V_{IH}$.
17. If \overline{CE}_1 goes HIGH or \overline{CE}_2 goes LOW simultaneously with \overline{WE} HIGH, the output remains in a high-impedance state.
18. During this period, the I/Os are in output state and input signals should not be applied.

Switching Waveforms (continued)
Write Cycle No. 3 ($\overline{\text{WE}}$ Controlled, $\overline{\text{OE}}$ LOW) ^[17]

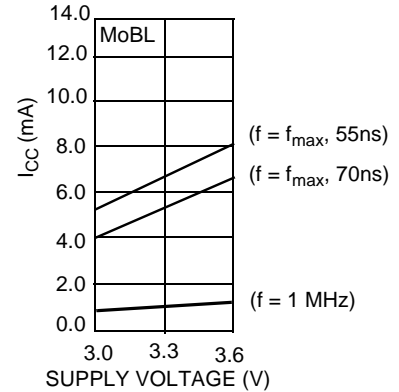
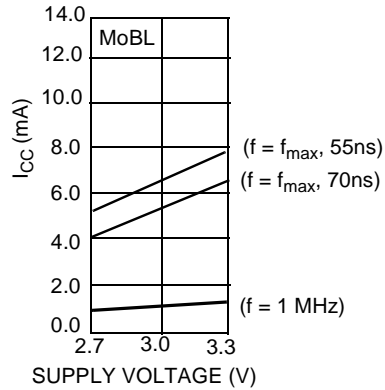
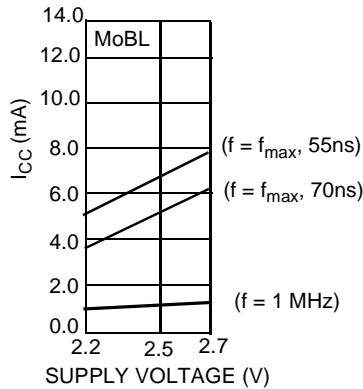
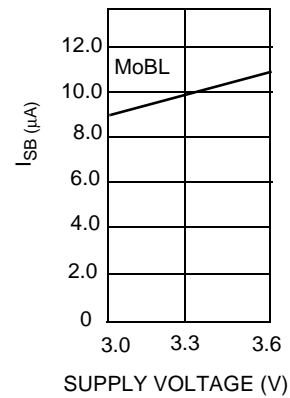
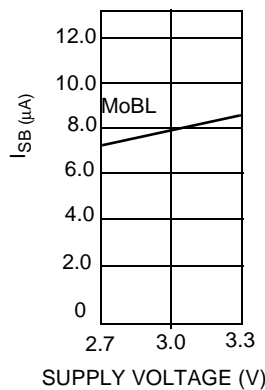
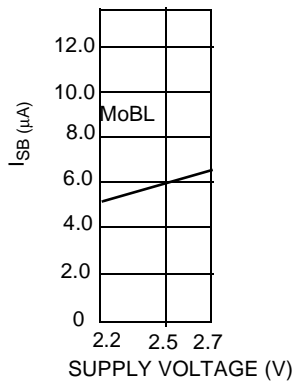
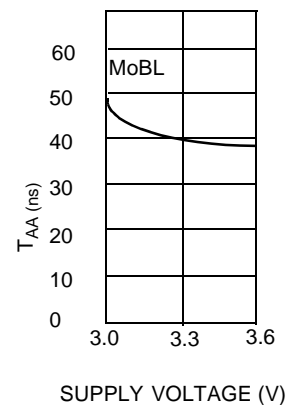
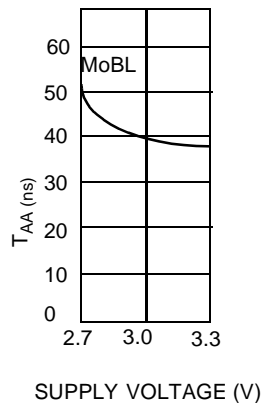
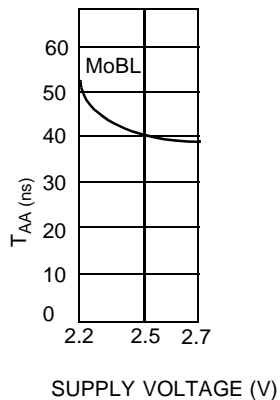
Write Cycle No. 4 ($\overline{\text{BHE/BLE}}$ Controlled, $\overline{\text{OE}}$ LOW) ^[17]

Typical DC and AC Characteristics

(Typical values are included for reference only and are not guaranteed or tested. Typical values are measured at $V_{CC} = V_{CC(typ)}$, $T_A = 25^\circ\text{C}$.)

Operating Current vs. Supply Voltage

Standby Current vs. Supply Voltage

Access Time vs. Supply Voltage

Truth Table

CE₁	CE₂	WE	OE	BHE	BLE	Inputs/Outputs	Mode	Power
H	X	X	X	X	X	High Z	Deselect/Power-Down	Standby (I _{SB})
X	L	X	X	X	X	High Z	Deselect/Power-Down	Standby (I _{SB})
X	X	X	X	H	H	High Z	Deselect/Power-Down	Standby (I _{SB})
L	H	H	L	L	L	Data Out (I/O ₀ –I/O ₁₅)	Read	Active (I _{CC})
L	H	H	L	H	L	Data Out (I/O ₀ –I/O ₇); I/O ₈ –I/O ₁₅ in High Z	Read	Active (I _{CC})
L	H	H	L	L	H	Data Out (I/O ₈ –I/O ₁₅); I/O ₀ –I/O ₇ in High Z	Read	Active (I _{CC})
L	H	H	H	L	L	High Z	Output Disabled	Active (I _{CC})
L	H	H	H	H	L	High Z	Output Disabled	Active (I _{CC})
L	H	H	H	L	H	High Z	Output Disabled	Active (I _{CC})
L	H	L	X	L	L	Data In (I/O ₀ –I/O ₁₅)	Write	Active (I _{CC})
L	H	L	X	H	L	Data In (I/O ₀ –I/O ₇); I/O ₈ –I/O ₁₅ in High Z	Write	Active (I _{CC})
L	H	L	X	L	H	Data In (I/O ₈ –I/O ₁₅); I/O ₀ –I/O ₇ in High Z	Write	Active (I _{CC})

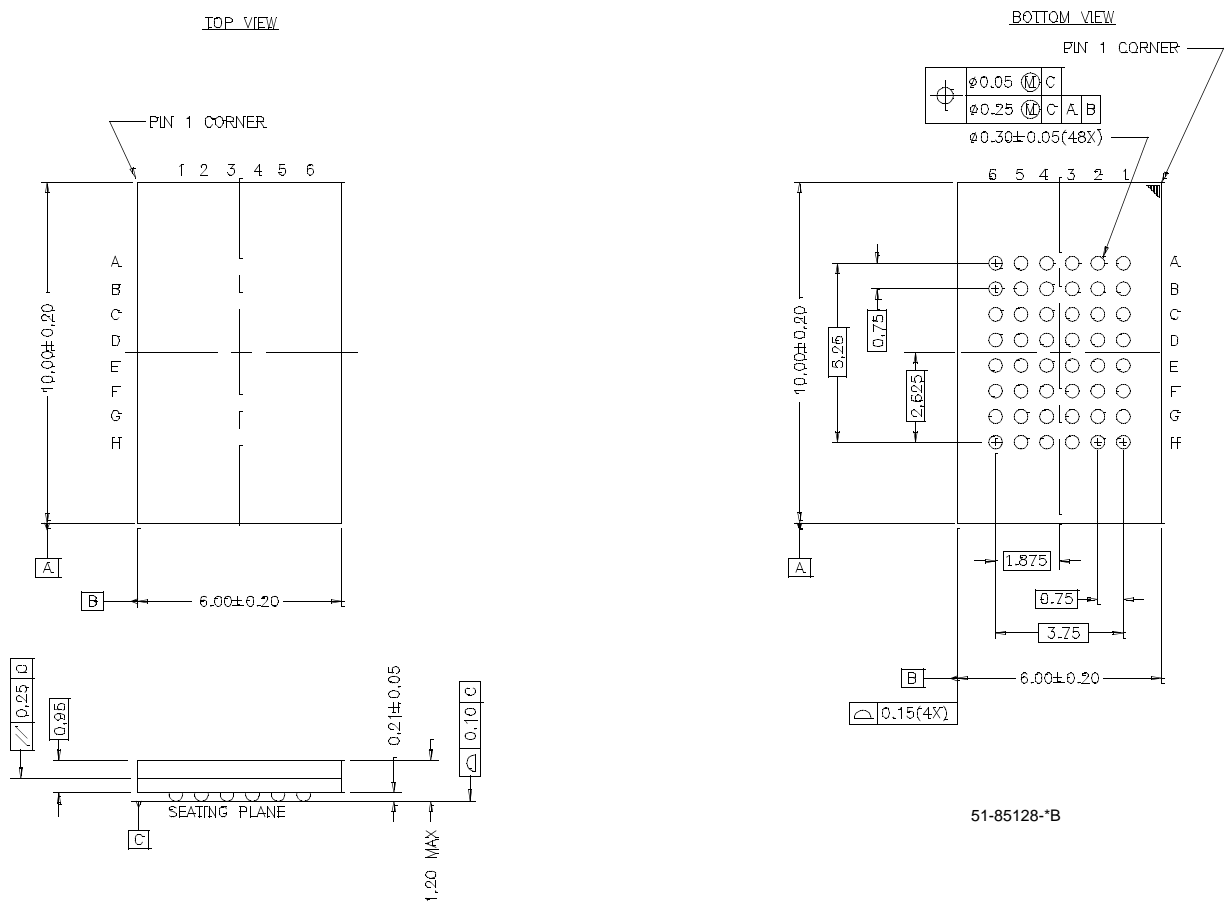
Ordering Information

Speed (ns)	Ordering Code	Package Name	Package Type	Operating Range
70	CY62157CV25LL-70BAI	BA48F	48-ball Fine-pitch BGA	Industrial
	CY62157CV30LL-70BAI			
	CY62157CV33LL-70BAI			
55	CY62157CV30LL-55BAI			
	CY62157CV33LL-55BAI			

Package Diagram
48-Ball (6 mm x 10 mm x 1.2 mm) FBGA BA48F

MoBL, MoBL2, and More Battery Life are trademarks of Cypress Semiconductor Corporation. All product and company names mentioned in this document may be the trademarks of their respective holders.



Document Title: CY62157CV25/30/33 MoBL™ 512K x 16 STATIC RAM
Document Number: 38-05014

REV.	ECN NO.	Issue Date	Orig. of Change	Description of Change
**	106184	05/10/01	HRT/MGN	New Datasheet – Advance Information
*A	107241	07/24/01	MGN	Make Corrections to Advance Information. Added 55 ns bin.
*B	109621	03/11/02	MGN	Change from Advance Information to Final
*C	114218	05/01/02	GUG/ MGN	Improved Typical & Max I _{CC} values