

TetraHub™ High Speed USB Hub Controller

Features

- USB 2.0 Hub
- Four Downstream Ports
- Multiple Transaction Translators - One per Downstream Port for Maximum Performance
- VID, PID, and DID configured from External SPI EEPROM
- 24 MHz External Crystal
- Small Package - Quad Flat Pack, No Leads (QFN)
- Integrated Upstream Pull Up Resistor
- Integrated Downstream Pull Down Resistors for all Downstream Ports
- Integrated Upstream and Downstream Series Termination Resistors
- Configurable with External SPI EEPROM
 - Number of Active Ports
 - Number of Removable Ports
 - Maximum Power
 - Hub Controller Power
 - Power On Timer
 - Over current Timer
 - Disable Over current Timer
 - Enable Full Speed Only
 - Disable Port Indicators
 - Gang Power Switching
 - Enable Single TT Mode Only
 - Enable NoEOP at EOF1

Logic Block Diagram

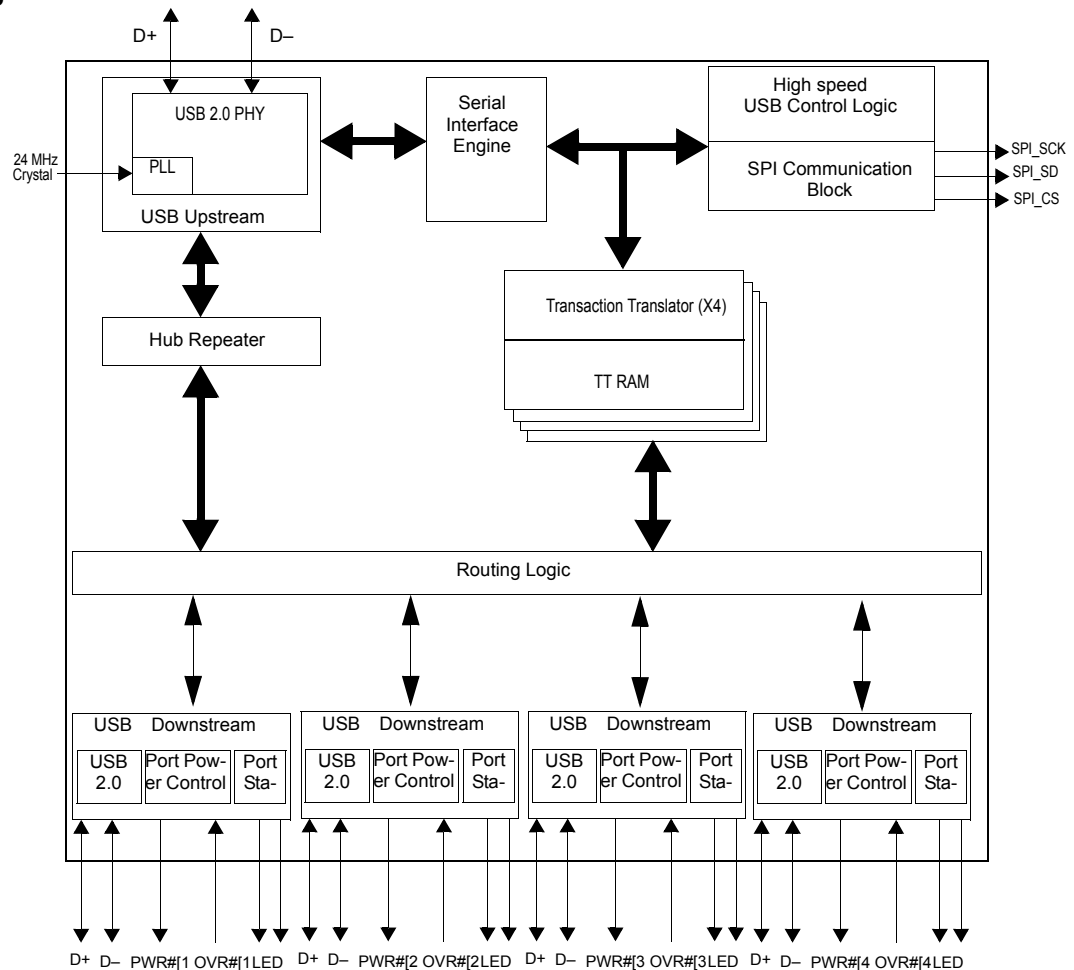

Contents

Introduction	3	Supported USB Requests	13
TetraHub Architecture	3	Device Class Commands	13
USB Serial Interface Engine (SIE)	3	Hub Class Commands	14
Hub Controller	3	Upstream USB Connection	15
Hub Repeater	3	Downstream USB Connections	16
Transaction Translator	3	LED Connections	16
Applications	3	Sample Schematic	17
Functional Overview	4	Maximum Ratings	18
System Initialization	4	Operating Conditions	18
Enumeration	4	DC Electrical Characteristics	18
Multiple Transaction Translator Support	4	AC Electrical Characteristics	19
Downstream Ports	4	Ordering Information	20
Upstream Port	4	Ordering Code Definitions	20
Power Switching	4	Package Diagram	21
Over current Detection	5	Quad Flat Package No Leads (QFN)	
Port Indicators	5	Package Design Notes	22
Pin Configuration	6	Document History Page	24
Default Descriptors	9	Sales, Solutions, and Legal Information	26
Device Descriptor	9	Worldwide Sales and Design Support	26
Configuration Options	12	Products	26
Default – 0xD0 Load	12	PSoC® Solutions	26
Configured – 0xD2 Load	12	Cypress Developer Community	26
		Technical Support	26

Introduction

Cypress's TetraHub™ is a high performance self powered Universal Serial Bus (USB) 2.0 hub. The Tetra architecture provides four downstream USB ports, with a Transaction Translator (TT) for each port, making it the highest performing hub possible. This single-chip device incorporates one upstream and four downstream USB transceivers, a serial Interface Engine (SIE), USB hub controller and repeater, and four TTs. It is suitable for standalone hubs, motherboard hubs, and monitor hub applications.

Being a fixed-function USB device, there is no risk or added engineering effort required for firmware development. The developer does not need to write any firmware for their design. The CY4602 Tetrahub USB 2.0 4-port Hub Reference Design Kit provides all materials and documents needed to move rapidly into production. The reference design kit includes board schematics, bill of materials, Gerber files, Orcad files, key application notes, and product description.

CY7C65640A-LFXC is a functional and pin equivalent die revision of Cypress's CY7C65640-LFXC. Changes were made to improve device performance.

TetraHub Architecture

The [Logic Block Diagram on page 1](#) shows the TetraHub Architecture.

USB Serial Interface Engine (SIE)

The SIE enables the CY7C65640A to communicate with the USB host through the USB repeater component of the hub. The SIE handles the following USB bus activity independently of the Hub Control Block:

- Bit stuffing/unstuffing
- Checksum generation/checking
- ACK/NAK/STALL
- TOKEN type identification
- Address checking.

Hub Controller

The hub control block does the following protocol handling at a higher level:

- Coordinate enumeration by responding to SETUP packets
- Fill and empty the FIFOs
- Suspend/Resume coordination
- Verify and select DATA toggle values
- Port power control and over current detection.

The Hub controller provides status and control and permits host access to the hub.

Hub Repeater

The hub repeater manages the connectivity between upstream and downstream facing ports that are operating at the same speed. It supports full/low speed connectivity and high speed connectivity. According to USB 2.0 specification, the hub repeater provides the following functions:

- Sets up and tears down connectivity on packet boundaries
- Ensures orderly entry into and out of the suspend state, including proper handling of remote wake ups.

Transaction Translator

The TT translates data from one speed to another. A TT takes high speed split transactions and translates them to full/low speed transactions when the hub is operating at high speed (the upstream port is connected to a high speed host controller) and has full/low speed devices attached. The operating speed of a device attached on a downstream facing port determines whether the routing logic connects a port to the transaction translator or hub repeater section. If a low or full speed device is connected to the hub operating at high speed, the data transfer route includes the transaction translator. If a high speed device is connected to this high speed hub the route only includes the repeater and no transaction translator; the device and the hub are in conformation with respect to their data transfer speed. When the hub is operating at full speed (the upstream port is connected to a full speed host controller), a high speed peripheral does not operate at its full capability. These devices only work at 1.1 speed. Full and low speed devices connected to this hub operate at their 1.1 speed.

Applications

- Standalone Hubs
- Motherboard Hubs
- Monitor Hub applications
- External Personal Storage Drives
- Port Replicators
- Portable Drive
- Docking Stations

Functional Overview

The Cypress TetraHub USB 2.0 hub is a high performance, low-system-cost solution for USB. This hub integrates 1.5k upstream pull up resistors for full speed operation and all downstream 15k pull down resistors and series termination resistors on all upstream and downstream D+ and D- pins. This results in optimization of system costs by providing built-in support for the USB 2.0 specification.

System Initialization

On power up, the TetraHub reads an external SPI EEPROM for configuration information. At the most basic level, this EEPROM has the Vendor ID (VID), Product ID (PID), and Device ID (DID) for the customer's application. For more specialized applications, other configuration options can be specified. See [Configuration Options on page 12](#) for more details.

After reading the EEPROM, if BUSPOWER (connected to the upstream VBus) is high, TetraHub enables the pull up resistor on the D+ to indicate that it is connected to the upstream hub, after which a USB bus reset is expected. During this reset, TetraHub initiates a chirp to indicate that it is a high speed peripheral. In a USB 2.0 system, the upstream hub responds with a chirp sequence, and TetraHub is in a high speed mode, with the upstream D+ pull up resistor turned off. In USB 1.x systems, no such chirp sequence from the upstream hub is seen, and TetraHub operates as a normal 1.x hub (operating at full speed).

Enumeration

After a USB Bus Reset, TetraHub is in an unaddressed, non-configured state (configuration value set to 0). During the enumeration process, the host sets the hub's address and configuration by sending a SetConfiguration request. Changing the hub address restores it to an non-configured state.

For high speed multi-TT support, the host must also set the alternate interface setting to 1 (the default mode is single TT). After the hub is configured, the full hub functionality is available.

Multiple Transaction Translator Support

After TetraHub is configured in a high speed system, it is in single TT mode. The host may then set the hub into multiple TT mode by sending a SetInterface command. In multiple TT mode, each full speed port is handled independently and thus has a full 12 Mbps bandwidth available. In Single TT mode, all traffic from the host destined for full or low speed ports are forwarded to all of those ports. This means that the 12 Mbps bandwidth is shared by all full and low speed ports.

Downstream Ports

TetraHub supports a maximum of four downstream ports, each of which may be marked as usable or removable in the extended configuration (0xD2 EEPROM load, see section). Downstream D+ and D- pull down resistors are incorporated in TetraHub for each port. Prior to the hub being configured, the ports are driven SE0 (Single Ended Zero, where both D+ and D- are driven low) and are set to the non-powered state.

After the hub is configured, the ports are not driven, and the host may power the ports by sending a SetPortPower command to each port. After a port is powered, any connect or disconnect event is detected by the hub. Any change in the port state is reported by the hub back to the host through the Status Change Endpoint (endpoint 1). Upon receipt of SetPortReset command from the host, the hub does the following:

- Drive SE0 on the corresponding port
- Put the port in an enabled state
- Enable the green port indicator for that port (if not previously overridden by the host)
- Enable babble detection after the port is enabled.

Babble consists of either non-terminated traffic from a downstream port (or loss of activity), or a non-idle condition on the port after EOF2. If babble is detected on an enabled port, that port is disabled. A ClearPortEnable command from the host also disables the specified port.

Downstream ports can be individually suspended by the host with the SetPortSuspend command. If the hub is not suspended, any resume will be confined to that individual port and reflected to the host through a port change indication in the Hub Status Change Endpoint. If the hub is suspended, a resume on this port will be forwarded to the host, but other resume events will not be seen on that port. The host may resume the port by sending a ClearPortSuspend command.

Upstream Port

The upstream port includes the transmitter and the receiver state machine. The transmitter and receiver operate in high speed and full speed depending on the current hub configuration.

The transmitter state machine monitors the upstream facing port while the hub repeater has connectivity in the upstream direction. This monitoring activity prevents propagation of erroneous indications in the upstream direction. In particular, this machine prevents babble and disconnect events on the downstream facing ports of this hub from propagating and causing the hub to be disabled or disconnected by the hub to which it is attached. This enables the hub to only disconnect the offensive port on detecting a babble from it.

Power Switching

TetraHub includes interface signals for external port power switches. Both ganged and individual (for each port) configurations are supported, with individual switching being the default. Initially all ports are non-powered. After enumerating, the host may power each port by sending a SetPortPower command for that port. The power switching and over current detection of downstream ports is managed by control pins connected to an external power switch device. PWR [n]# output pins of the CY7C65640A series are connected to the respective external power switch's port power enable signals. (Note that each port power output pin of the external power switch must be bypassed with an electrolytic or tantalum capacitor as required by the USB specification. These capacitors supply the inrush currents, which occur during downstream device hot-attach events.)

Over current Detection

Over current detection includes timed detection of 8 ms by default. This parameter is configured from the external EEPROM in a range of 0 ms to 15 ms for both an enabled port and a disabled port individually. Detection of over on downstream ports is managed by control pins connected to an external power switch device.

The OVR[n]# pins of the CY7C65640A series are connected to the respective external power switch's port over current indication (output) signals. Upon detecting an over current condition, the hub device reports the over current condition to the host and disables the PWR# output to the external power device.

Port Indicators

The USB 2.0 port indicators are also supported directly by TetraHub. According to the specification, each downstream port of the hub supports an optional status indicator. The presence of indicators for downstream facing ports is specified by bit 7 of the wHubCharacteristics field of the hub class descriptor. The default TetraHub descriptor specifies that port indicators are supported (wHubCharacteristics, bit 7 is set). If port indicators are not included in the hub, EEPROM should disable this.

Each port indicator is strategically located directly on the opposite edge of the port which it is associated with. The indicator provides two colors: green and amber. This is implemented as two separate LEDs, one amber and the other green. A combination of hardware and software control is used

to inform the user of the current status of the port or the device attached to the port and to guide the user through problem resolution. Colors and blinking are used to provide information to the user. The significance of the color of the LED depends on the operational mode of the TetraHub. There are two modes of operation for the TetraHub port indicators: automatic and manual.

On power up, the TetraHub defaults to automatic mode, where the color of the port indicator (green, amber, off) indicates the functional status of the TetraHub port. In automatic mode, TetraHub turns on the green LED whenever the port is enabled and the amber LED when it detects an over current condition. The color of the port indicator is set by the port state machine. Blinking of the LEDs is not supported in automatic mode. Table 1 identifies the mapping of color to port state in automatic mode.

In manual mode, the indicators are under the control of the host, which can turn on one of the LEDs, or leave them off. This is done by a system software USB Hub class request. Blinking of the LEDs is supported in manual mode. The port indicators enable the user to intervene on any error detection. For example, when babble is detected on plugging in a defective device, or on occurrence of an over current condition, the port indicators corresponding to the downstream port blink green or only light the amber LED, respectively. Table 2 displays the color definition of the indicators when TetraHub is in manual mode.

Table 1. Automatic Port State to Port Indicator Color Mapping

Port Switching	Downstream Facing Hub Port State			
	Powered Off	Disconnected, Disabled, Not Configured, Resetting, Testing	Enabled, Transmit, or TransmitR	Suspended, Resuming, SendEOR, Restart_E/S
With	Off or amber if due to an over current condition	Off	Green	Off
Without	Off	Off or amber if due to an overcurrent condition	Green	Off

Table 2. Port Indicator Color Definitions in Manual Mode

Color Definition	Port State
Off	Not operational
Amber	Error condition
Green	Fully operational
Blinking Off/Green	Software attention
Blinking Off/Amber	Hardware attention
Blinking Green/Amber	Reserved

Note. Information presented in Table 1 and Table 2 is from USB 2.0 specification tables 11-6 and 11-7, respectively.

Pin Configuration

Figure 1. 56-pin Quad Flat Pack No Leads (8 mm × 8 mm)

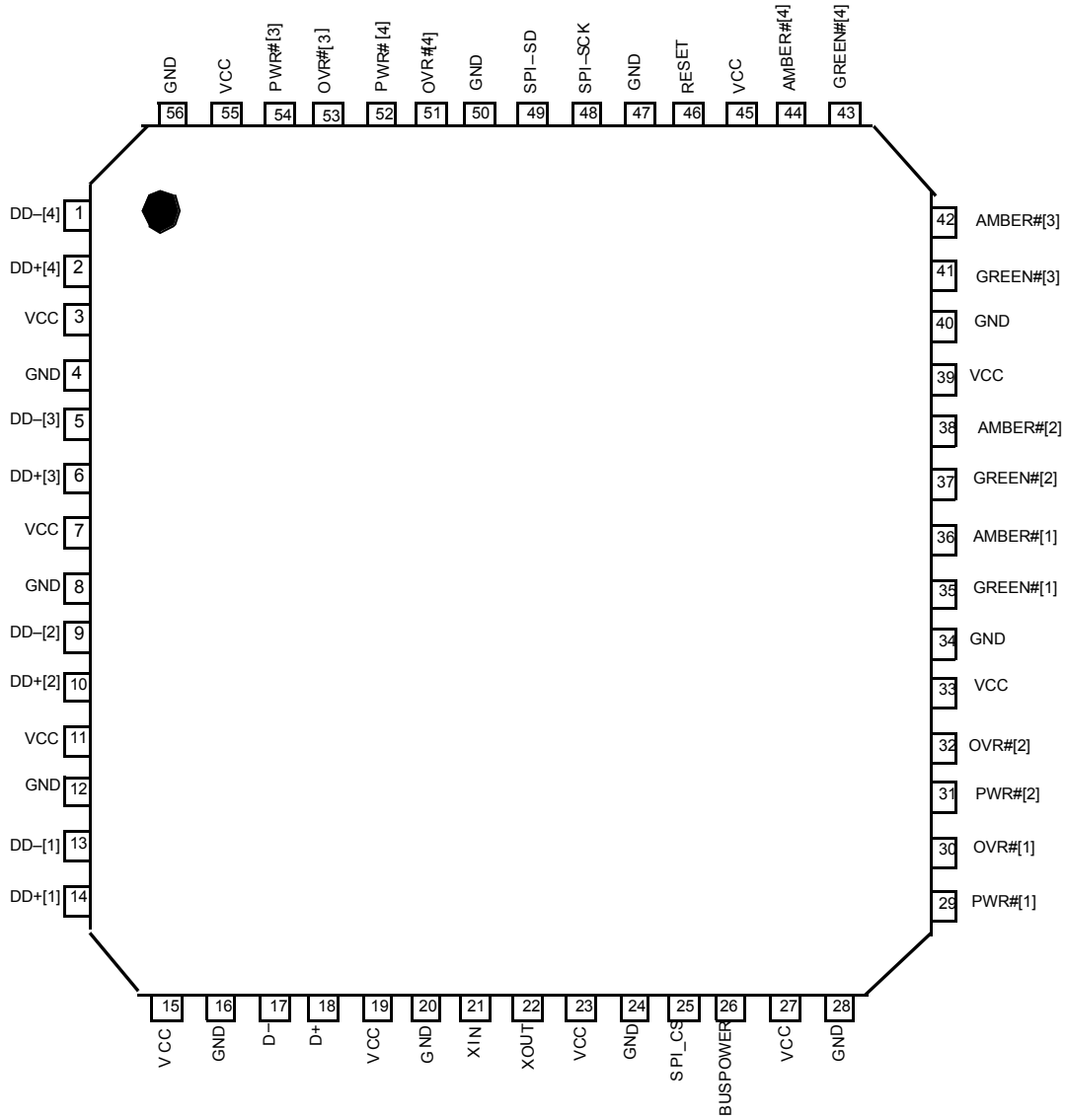

Table 3. CY7C65640A Pin Assignments

Pin	Name	Type	Default	Description
3	VCC	Power	N/A	V_{CC} . This signal provides power to the chip.
7	VCC	Power	N/A	V_{CC} . This signal provides power to the chip.
11	VCC	Power	N/A	V_{CC} . This signal provides power to the chip.
15	VCC	Power	N/A	V_{CC} . This signal provides power to the chip.
19	VCC	Power	N/A	V_{CC} . This signal provides power to the chip.
23	VCC	Power	N/A	V_{CC} . This signal provides power to the chip.
27	VCC	Power	N/A	V_{CC} . This signal provides power to the chip.
33	VCC	Power	N/A	V_{CC} . This signal provides power to the chip.
39	VCC	Power	N/A	V_{CC} . This signal provides power to the chip.
45	VCC	Power	N/A	V_{CC} . This signal provides power to the chip.
55	VCC	Power	N/A	V_{CC} . This signal provides power to the chip.
4	GND	Power	N/A	GND . Connect to Ground with as short a path as possible.
8	GND	Power	N/A	GND . Connect to Ground with as short a path as possible.
12	GND	Power	N/A	GND . Connect to Ground with as short a path as possible.
16	GND	Power	N/A	GND . Connect to Ground with as short a path as possible.
20	GND	Power	N/A	GND . Connect to Ground with as short a path as possible.
24	GND	Power	N/A	GND . Connect to Ground with as short a path as possible.
28	GND	Power	N/A	GND . Connect to Ground with as short a path as possible.
34	GND	Power	N/A	GND . Connect to Ground with as short a path as possible.
40	GND	Power	N/A	GND . Connect to Ground with as short a path as possible.
47	GND	Power	N/A	GND . Connect to Ground with as short a path as possible.
50	GND	Power	N/A	GND . Connect to Ground with as short a path as possible.
56	GND	Power	N/A	GND . Connect to Ground with as short a path as possible.
21	XIN	Input	N/A	24 MHz Crystal IN or External Clock Input.
22	XOUT	Output	N/A	24 MHz Crystal OUT.
46	RESET#	Input	N/A	Active LOW Reset. This pin resets the entire chip. It is normally tied to V _{CC} through a 100K resistor, and to GND through a 0.1 μF capacitor. Other than this, no other special power up procedure is required.
26	BUSPOWER	Input	N/A	VBUS. Connect to the VBUS pin of the upstream connector. This signal indicates to the hub that it is in a powered state, and may enable the D+ pull up resistor to indicate a connection. (The hub does so after the external EEPROM is read, unless it is put into a high speed mode by the upstream hub). The hub cannot be bus powered, and the VBUS signal must not be used as a power source.
SPI INTERFACE				
25	SPI_CS	O	O	SPI Chip Select. Connect to CS pin of the EEPROM.
48	SPI_SCK	O	O	SPI Clock. Connect to EEPROM SCK pin.
49	SPI_SD	I/O/Z	Z	SPI Dataline Connect to GND with 15 KΩ resistor and to the Data I/O pins of the EEPROM.
UPSTREAM PORT				
17	D-	I/O/Z	Z	Upstream D- Signal.
18	D+	I/O/Z	Z	Upstream D+ Signal.

Table 3. CY7C65640A Pin Assignments (continued)

Pin	Name	Type	Default	Description
DOWNSTREAM PORT 1				
13	DD-[1]	I/O/Z	Z	Downstream D- Signal.
14	DD+[1]	I/O/Z	Z	Downstream D+ Signal.
36	AMBER#[1]	O	1	LED. Driver output for amber LED. Port Indicator Support. Active LOW.
35	GREEN#[1]	O	1	LED. Driver output for green LED. Port Indicator Support. Active LOW.
30	OVR#[1]	Input	1	Overcurrent Condition Detection Input. Active LOW.
29	PWR#[1]	O/Z	Z	Power Switch Driver Output. Active LOW.
DOWNSTREAM PORT 2				
9	DD-[2]	I/O/Z	Z	Downstream D- Signal.
10	DD+[2]	I/O/Z	Z	Downstream D+ Signal.
38	AMBER#[2]	O	1	LED. Driver output for amber LED. Port Indicator Support. Active LOW.
37	GREEN#[2]	O	1	LED. Driver output for green LED. Port Indicator Support. Active LOW.
32	OVR#[2]	Input	1	Overcurrent Condition Detection Input. Active LOW.
31	PWR#[2]	O/Z	Z	Power Switch Driver Output. Active LOW.
DOWNSTREAM PORT 3				
5	DD-[3]	I/O/Z	Z	Downstream D- Signal.
6	DD+[3]	I/O/Z	Z	Downstream D+ Signal.
42	AMBER#[3]	O	1	LED. Driver output for Amber LED. Port Indicator Support. Active LOW.
41	GREEN#[3]	O	1	LED. Driver output for Green LED. Port Indicator Support. Active LOW.
53	OVR#[3]	Input	1	Overcurrent Condition Detection Input. Active LOW.
54	PWR#[3]	O/Z	Z	Power Switch Driver Output. Active LOW.
DOWNSTREAM PORT 4				
1	DD-[4]	I/O/Z	Z	Downstream D- Signal.
2	DD+[4]	I/O/Z	Z	Downstream D+ Signal.
44	AMBER#[4]	O	1	LED. Driver output for Amber LED. Port Indicator Support. Active LOW.
43	GREEN#[4]	O	1	LED. Driver output for Green LED. Port Indicator Support. Active LOW.
51	OVR#[4]	Input	1	Overcurrent Condition Detection Input. Active LOW.
52	PWR#[4]	O/Z	Z	Power Switch Driver Output. Active LOW.

Unused port DD+/DD- lines can be left floating. The port power, amber, and green LED pins should be left unconnected, and the over current pin should be tied high. The over current pin is an input and it should not be left floating.

Default Descriptors

Device Descriptor

The standard device descriptor for TetraHub is based on the VID, PID, and DID found in the SPI EEPROM. This VID/PID/DID in the EEPROM overwrites the default VID/PID/DID. If no EEPROM is used, the TetraHub enumerates with the following default descriptor values.

Table 4. Tetra Hub Descriptor Values

Byte	Full Speed	High Speed	Field Name	Description
0	0x12	0x12	bLength	18 Bytes
1	0x01	0x01	bDescriptorType	DEVICE_DESCRIPTOR
2,3	0x0200	0x0200	bcdUSB	USB specification 2.0
4	0x09	0x09	bDeviceClass	HUB
5	0x00	0x00	bDeviceSubClass	None
6	0x00	0x02	bDeviceProtocol	None
7	0x40	0x40	bMaxPacketSize0	64 bytes
8,9	0x04B4	0xx04B4	wIdVendor	VID (overwritten by what is defined in EEPROM)
10,11	0x6560	0x6560	wIdProduct	PID (overwritten by what is defined in EEPROM)
12, 13	0x000B	0x000B	wBcdDevice	DID (overwritten by what is defined in EEPROM)
14	0x00	0x00	iManufacturer	No manufacturer string supported
15	0x00	0x00	iProduct	No product string supported
16	0x00	0x00	iSerialNumber	No serial string supported
17	0x01	0x01	bNumConfigurations	One configuration supported

Table 5. Configuration Descriptor

Byte	Full Speed	High Speed	Field Name	Description
0	0x09	0x09	bLength	9 Bytes
1	0x02	0x02	bDescriptorType	CONFIG_DESCRIPTOR
2	0x0019	0x0029 ^[1]	wTotalLength	Length of all other descriptors
4	0x01	0x01	bNumInterfaces	1
5	0x01	0x01	bConfigurationValue	The configuration to be used
6	0x00	0x00	iConfiguration	
7	0xE0	0xE0	bmAttributes	
8	0x32	0x32 ^[2]	bMaxPower	

Table 6. Interface Descriptor

Byte	Full Speed	High Speed	Field Name	Description
0	0x09	0x09	bLength	9 Bytes
1	0x04	0x04	bDescriptorType	INTERFACE_DESCRIPTOR
2	0x00	0x00	bInterfaceNumber	
3	0x00	0x00	bAlternateSetting	
4	0x01	0x01	bNumEndpoints	
5	0x09	0x09	bInterfaceClass	
6	0x00	0x00	bInterfaceSubClass	
7	0x00	0x01	bInterfaceProtocol	
8	0x00	0x00	iInterface	

Notes

1. This value is reported as 0x19 if the hub is configured in Single-TT mode.
2. This value is configured through the External EEPROM.

Table 7. Endpoint Descriptor

Byte	Full Speed	High Speed	Field Name	Description
0	0x07	0x07	bLength	7 Bytes
1	0x05	0x05	bDescriptorType	ENDPOINT_DESCRIPTOR
2	0x81	0x81	bEndpointAddress	IN Endpoint #1
3	0x03	0x03	bmAttributes	Interrupt
4,5	0x0001	0x0001	wMaxPacketSize	Maximum packet size
6	0xFF	0x0C	bInterval	Polling rate

Table 8. Interface Descriptor^[3]

Byte	Full Speed	High Speed	Field Name	Description
0	N/A	0x09	bLength	9 Bytes
1	N/A	0x04	bDescriptorType	INTERFACE_DESCRIPTOR
2	N/A	0x00	bInterfaceNumber	Interface descriptor index
3	N/A	0x01	bAlternateSetting	Alternate setting for the interface
4	N/A	0x01	bNumEndpoints	Number of endpoints defined
5	N/A	0x09	bInterfaceClass	Interface class
6	N/A	0x00	bInterfaceSubClass	Interface sub-class
7	N/A	0x02	bInterfaceProtocol	Interface protocol
8	N/A	0x00	bInterface	Interface string index

Table 9. Endpoint Descriptor^[3]

Byte	Full Speed	High Speed	Field Name	Description
0	N/A	0x07	bLength	7 Bytes
1	N/A	0x05	bDescriptorType	ENDPOINT_DESCRIPTOR
2	N/A	0x81	bEndpointAddress	IN Endpoint #1
3	N/A	0x03	bmAttributes	Interrupt
4,5	N/A	0x0001	wMaxPacketSize	Maximum packet size
6	N/A	0x0C	bInterval	Polling rate

Table 10. Device Qualifier Descriptor

Byte	Full Speed	High Speed	Field Name	Description
0	0x0A	0x0A	bLength	10 Bytes
1	0x06	0x06	bDescriptorType	DEVICE_QUALIFIER
2,3	0x0200	0x0200	bcdUSB	
4	0x09	0x09	bDeviceClass	
5	0x00	0x00	bDeviceSubClass	
6	0x02	0x00	bDeviceProtocol	
7	0x40	0x40	bMaxPacketSize0	
8	0x01	0x01	bNumConfigurations	
9	0x00	0x00	bReserved	

Note

3. If TetraHub is configured for single-TT only (from the external EEPROM), this descriptor is not present.

Table 11. Hub Descriptor

Byte	All Speeds	Field Name	Description
0	0x09	bLength	9 Bytes
1	0x29	bDescriptorType	HUB descriptor
2	0x04 ^[4]	bNbrPorts	Number of ports supported
3,4	0x0089 ^[4]	wHubCharacteristics	<p>b1, b0: Logical Power Switching Mode 00: Ganged power switching (all ports' power at once) 01: Individual port power switching (Default in TetraHub)</p> <p>b2: Identifies a Compound Device, 0: Hub is not part of a compound device (Default in TetraHub), 1: Hub is part of a compound device.</p> <p>b4, b3: Overcurrent protection mode 00: Global overcurrent protection. The hub reports overcurrent as a summation of all ports current draw, without a breakdown of individual port overcurrent status. 01: Individual port overcurrent protection. The hub reports overcurrent on a per-port basis. Each port has an overcurrent status (Default in TetraHub). 1X: No overcurrent protection. This option is enabled only for bus-powered hubs that do not implement overcurrent protection.</p> <p>b6, b5: TT Think Time 00: TT requires at most 8 FS bit times of inter transaction gap on a full/low speed downstream bus (Default in TetraHub). 01: TT requires at most 16 FS bit times. 10: TT requires at most 24 FS bit times. 11: TT requires at most 32 FS bit times.</p> <p>b7: Port indicators supported, 0: Port indicators are not supported on its downstream facing ports and the PORT_INDICATOR request has no effect. 1: Port indicators are supported on its downstream facing ports and the PORT_INDICATOR request controls the indicators.</p> <p>b15...b8: Reserved</p>
5	0x32 ^[4]	bPwrOn2PwrGood	Time from when the port is powered to when the power is good on that port
6	0x64 ^[4]	bHubContrCurrent	Maximum current requirement for the hub controller
7	0x00 ^[4]	bDeviceRemovable	Indicates if the port has a removable device attached
8	0xFF ^[4]	bPortPwrCtrlMask	Required for compatibility with software written for 1.0 compliant devices

Note

4. This value is configured through the External EEPROM.

Configuration Options

Systems using TetraHub must have an external EEPROM for the device to have a unique VID, PID, and DID. The TetraHub can talk to SPI EEPROM that are double byte addressable only. TetraHub uses the command format from the '040 parts. The TetraHub cannot talk to '080 EEPROM parts, as the read command format used for talking to '080 is not the same as '040. The '010s and '020s uses the same command format as used to interface with the '040 and hence these can also be used to interface with the TetraHub.

Default – 0xD0 Load

When used in default mode, only a unique VID, PID, and DID must be present in the external SPI EEPROM. The contents of the EEPROM must contain this information in the following format:

Byte	Value
0	0xD0
1	VID (LSB)
2	VID (MSB)
3	PID (LSB)
4	PID (MSB)
5	DID (LSB)
6	DID (MSB)

Configured – 0xD2 Load

Byte	Value (MSB->LSB)
0	0xD2
1	VID (LSB)
2	VID (MSB)
3	PID (LSB)
4	PID (MSB)
5	DID (LSB)
6	DID (MSB)
7	EnableOverCurrentTimer[3:0], DisableOvercurrent-Timer[3:0]
8	ActivePorts[3:0], RemovablePorts[3:0]
9	MaxPower
10	HubControllerPower
11	PowerOnTimer
12	IllegalHubDescriptor, Unused, FullspeedOnly, NoPortIndicators, Reserved, GangPowered, SingleTTOOnly, NoEOPatEOF1

Byte 0: 0xD2

Needs to be programmed with 0xD2

Byte 1: VID (LSB)

Least Significant Byte of Vendor ID

Byte 2: VID (MSB)

Most Significant Byte of Vendor ID

Byte 3: PID (LSB)

Least Significant Byte of Product ID

Byte 4: PID (MSB)]

Most Significant Byte of Product ID

Byte 5: DID (LSB)

Least Significant Byte of Device ID

Byte 6: DID (MSB)]

Most Significant Byte of Device ID

Byte 7: EnableOvercurrentTimer[3:0], DisabledOvercurrent-Timer[3:0]

Count time in ms for filtering over current detection. Bits 7–4 are for an enabled port, and bits 3–0 are for a disabled port. Both range from 0 ms to 15 ms. See “Port Indicators” on page 5. Default: 8 ms = 0x88.

Byte 8: ActivePorts[3:0], RemovablePorts[3:0]

Bits 7–4 are the ActivePorts[3:0] bits that indicates if the corresponding port is usable. For example, a two-port hub that uses ports 1 and 4 sets this field to 0x09. The total number of ports reported in the hub descriptor: bNbrPorts field is calculated from this. Bits 3–0 are the RemovablePorts[3:0] bits that indicates whether the corresponding port is removable (set to HIGH). This bit's values are recorded appropriately in the HubDescriptor:DeviceRemovable field. Default: 0xFF.

Byte 9: MaximumPower

This value is reported in the ConfigurationDescriptor:bMaxPower field and is the current in 2 mA intervals that is required from the upstream hub. Default: 0x32 = 100 mA

Byte 10: HubControllerPower

This value is reported in the HubDescriptor:bHubContrCurrent field and is the current in milliamperes required by the hub controller. Default: 0x64 = 100 mA.

Byte 11: PowerOnTimer

This value is reported in the HubDescriptor:bPwrOn2PwrGood field and is the time in 2 ms intervals from the SetPortPower command until the power on the corresponding downstream port is good. Default: 0x32 = 100 ms.

Byte 12: IllegalHubDescriptor, Unused, FullspeedOnly, NoPortIndicators, Reserved, GangPowered, SingleTTOOnly, NoEOPatEOF1

Bit 7: IllegalHubDescriptor: For GetHubDescriptor request, some USB hosts use a DescriptorTypeof 0x00 instead of HUB_DESCRIPTOR, 0x29. According to the USB 2.0 standard, a hub must treat this as a Request Error, and stall the transaction accordingly (USB 2.0, 11.24.2.5). For systems

that do not accept this, the IllegalHubDescriptor configuration bit may be set to enable TetraHub to accept a DescriptorType of 0x00 for this command. Default is 0, recommended setting is 1.

Bit 6: Unused: This bit is an unused, 'don't care' bit and can be set to anything.

Bit 5: Fullspeed: Only configures the hub to be a full speed only device. Default set to 0.

Bit 4: NoPortIndicators: Turns off the port indicators and does not report them as present in the HubDescriptor, wHubCharacteristics b7 field. Default set to 0.

Bit 3: Reserved: This bit is reserved and should not be set to 1. Must be set to 0.

Bit 2: GangPowered: Indicates whether the port power switching is ganged (set to 1) or per-port (set to 0). This is reported in the HubDescriptor, wHubCharacteristics field, b4, b3, b1, and b0. Default set to 0.

Bit 1: SingleTTOOnly: Indicates that the hub should only support single transaction translator mode. This changes various descriptor values. Default set to 0.

Bit 0: NoEOPatEOF1 turns off the EOP generation at EOF1 in full speed mode. Note that several USB 1.1 hosts cannot handle EOPatEOF1 properly. Cypress recommends that this option be turned off for general purpose hubs. Default is 0, recommended setting is 1.

Supported USB Requests

Device Class Commands

Table 12. Device Class Requests

Request	bmRequestType	bRequest	wValue	wIndex	wLength	Data
GetDeviceStatus	10000000B	0x00	0x0000	0x0000	0x0002	2 Byte Device Status
GetInterfaceStatus	10000001B	0x00	0x0000	0x0000	0x0002	2 Byte Endpoint Status
GetEndpointStatus	10000010B	0x00	0x0000	0x0000	0x0002	2 Byte Endpoint Status
GetDeviceDescriptor	10000000B	0x06	0x0001	Zero or Language ID	Descriptor Length	Descriptor
GetConfigDescriptor	10000000B	0x06	0x0002	Zero or Language ID	Descriptor Length	Descriptor
GetDeviceQualifierDescriptor	10000000B	0x06	0x0006	Zero or Language ID	Descriptor Length	Descriptor
GetOtherSpeedConfigurationDescriptor	10000000B	0x06	0x0007	Zero or Language ID	Descriptor Length	Descriptor
GetConfiguration ^[5]	10000000B	0x08	0x0000	0x0000	0x0001	Configuration value
SetCongfiguration ^[5]	00000000B	0x09	Configuration Value	0x0000	0x0000	None
GetInterface	10000001B	0xA	0x0000	0x0000	0x0001	Interface Number
SetInterface	00000001B	0x0B	Alternate Setting	Interface Number	0x0000	None
SetAddress	00000000B	0x05	Device Address	0x0000	0x0000	None
SetDeviceRemoteWakeup	00000000B	0x03	0x01	0x0000	0x0000	None
SetDeviceTest_J	00000000B	0x03	0x02	0x0100	0x0000	None
SetDeviceTest_K	00000000B	0x03	0x02	0x0200	0x0000	None
SetDeviceTest_SE0_NAK	00000000B	0x03	0x02	0x0300	0x0000	None
SetDeviceTest_Packet	00000000B	0x03	0x02	0x0400	0x0000	None
SetEndpointHalt	00000000B	0x03	0x00	0x0000	0x0000	None
ClearDeviceRemoteWakeup	00000000B	0x01	0x01	0x0000	0x0000	None
ClearEndpointHalt	00000000B	0x01	0x00	0x0000	0x0000	None

Note

5. Only one configuration is supported in TetraHub.

Hub Class Commands

Table 13. Hub Class Requests

Request	bmRequestType	bRequest	wValue	wIndex	wLength	Data
GetHubStatus	10100000B	0x00	0x0000	0x0000	0x0004	Hub Status (See Table 11-19 of Spec) Change Status (See Table 11-20 of Spec)
GetPortStatus	10100011B	0x00	0x0000	Byte 0: 0x00 Byte 1: Port	0x0004	Port Status (See Table 11-21 of Spec) Change Status (See Table 11-20 of Spec)
ClearHubFeature	00100000B	0x01	Feature Selectors ^[6] 0 or 1	0x0000	0x0000	None
ClearPortFeature	00100011B	0x01	Feature Selectors ^[6] 1, 2, 8, 16, 17, 18, 19, or 20	Byte 0: 0x00 Byte 1: Port	0x0000	None
ClearPortFeature	00100011B	0x01	Feature Selectors ^[6] 22 (PORT_INDICATOR)	Byte 0: Selectors ^[7] 0, 1, 2, or 3 Byte 1: Port	0x0000	None
SetHubFeature	00100000B	0x03	Feature Selector ^[6]	0x0000	0x0000	TetraHub STALLs this request
SetPortFeature	00100011B	0x03	Feature Selectors ^[6] 2, 4 or 8	Port	0x0000	None
SetPortFeature	00100011B	0x03	Feature Selector ^[6] 21 (PORT_TEST)	Byte 0: Selectors ^[8] 1,2, 3, 4 or 5 Byte 1: Port	0x0000	None
SetPortFeature	00100011B	0x03	Feature Selector ^[6] 22 (PORT_INDICATOR)	Byte 0: Selectors ^[7] 0, 1, 2, or 3 Byte 1: Port	0x0000	None
GetHubDescriptor	10100000B	0x06	Descriptor Type and Descriptor Index		Hub Descriptor Length	
ClearTTBuffer	00100011B	0x08	Dev_Addr, EP_Num	TT_Port	0x0000	None
ResetTT	00100000B	0x09	0x0000	Byte 0: 0x00 Byte 1: Port	0x0000	None
GetTTState	10100011B	0x0A	TT_Flags	Byte 0: 0x00 Byte 1: Port	TT State Length	TT State
StopTT	00100011B	0x0B	0x0000	Byte 0: 0x00 Byte 1: Port	0x0000	None

Notes

- 6. Feature selector values for different features are presented in Table 14.
- 7. Selector values for different features are presented in Table 16.
- 8. Selector values for different features are presented in Table 15.

Table 14. Hub Class Feature Selector

Feature Selector	Recipient	Value
C_HUB_LOCAL_POWER	Hub	0
C_HUB_OVER_CURRENT	Hub	1
PORT_CONNECTION	Port	0
PORT_ENABLE	Port	1
PORT_SUSPEND	Port	2
PORT_RESET	Port	4
PORT_POWER	Port	8
PORT_LOW_SPEED	Port	9
C_PORT_CONNECTION	Port	16
C_PORT_ENABLE	Port	17
C_PORT_SUSPEND	Port	18
C_PORT_OVER_CURRENT	Port	19
C_PORT_RESET	Port	20
PORT_TEST	Port	21
PORT_INDICATOR	Port	22

Table 15. Test Mode Selector for Feature Selector PORT_TEST (0x21)

PORT_TEST Mode Description	Selector Value
Test_J	1
Test_K	2
Test_SE0_NAK	3
Test_Packet	4
Test_Force_Enable	5

Table 16. Port Indicator Selector for Feature Selector PORT_INDICATOR (0x22)

Port Indicator Color	Selector Value	Port Indicator Mode
Color Set Automatically as shown in Table 1	0	Automatic Mode
Amber	1	Manual Mode
Green	2	Manual Mode
Off	3	Manual Mode

Upstream USB Connection

The following is a schematic of the USB upstream connector.

Figure 2. USB Upstream Port Connection

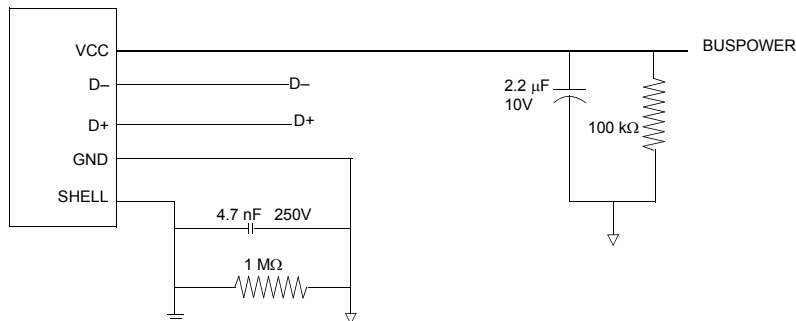

Downstream USB Connections

The following is a schematic of the USB downstream connector.

Figure 3. USB Downstream Port Connection

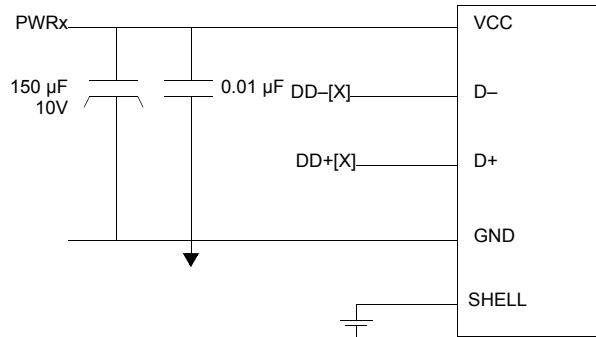

LED Connections

The following is a schematic of the LED circuitry.

Figure 4. USB Downstream Port Connection

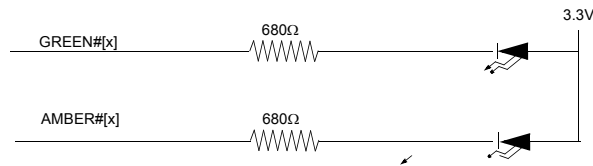

Sample Schematic

Figure 5. Sample Schematic

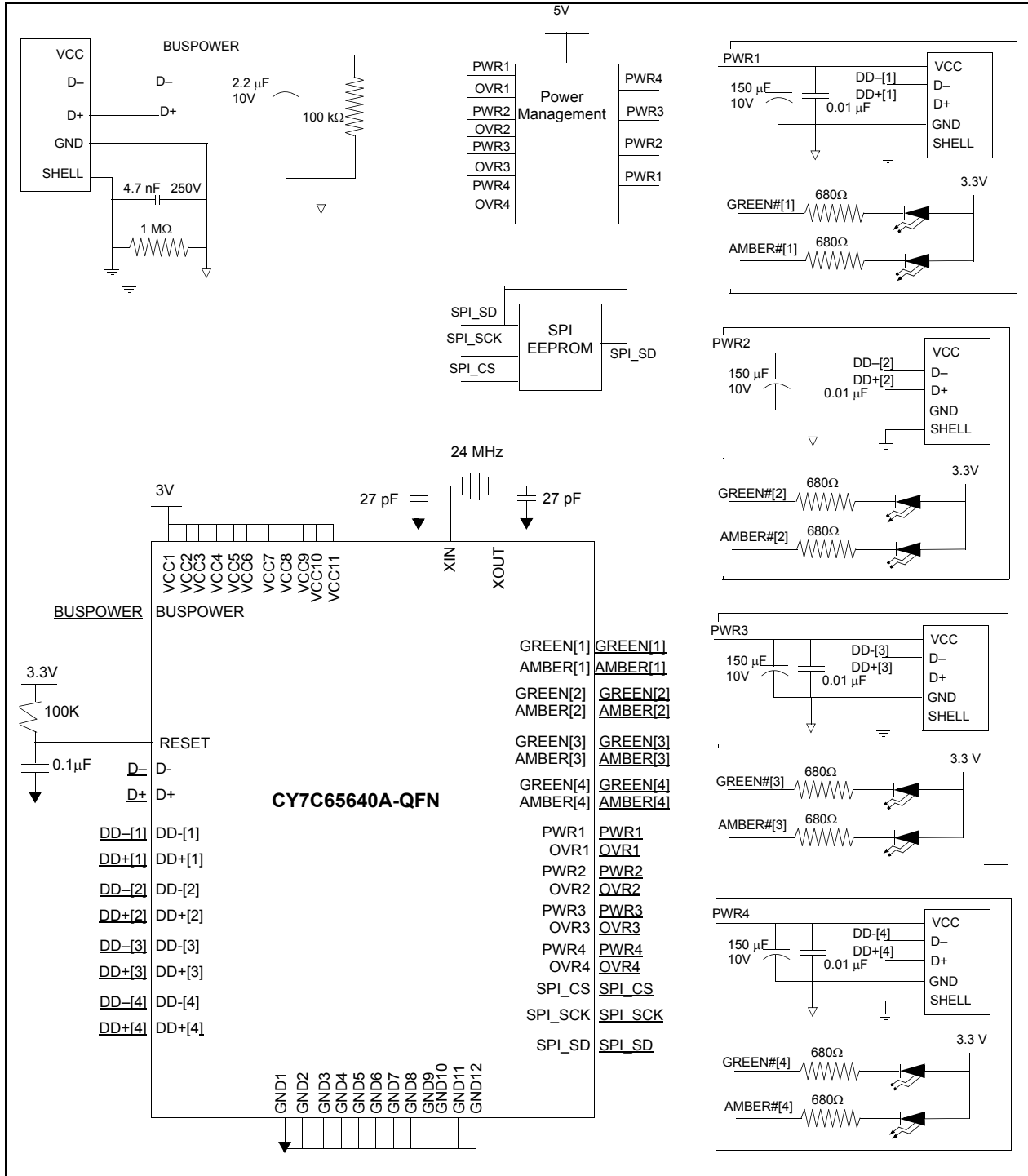

Maximum Ratings

Storage Temperature	-65 °C to +150 °C
Ambient Temperature with Power Applied	0 °C to +70 °C
Supply Voltage to Ground Potential	-0.5 V to +4.0 V
DC Voltage Applied to Outputs in High Z State	-0.5 V to $V_{CC} + 0.5 V$
Power Dissipation (4 HS ports).....	1.6 W
Static Discharge Voltage.....	> 2000 V
Maximum Output Sink Current per I/O	10 mA

Operating Conditions

T_A (Ambient Temperature Under Bias).....	0 °C to +70 °C
Supply Voltage.....	+3.15 V to +3.45 V
Ground Voltage.....	0 V
FOSC (Oscillator or Crystal Frequency).....	24 MHz \pm 0.05%, parallel resonant, fundamental mode, 27 pF load capacitance, 0.5 mW

DC Electrical Characteristics

Parameter	Description	Conditions	Min	Typ	Max	Unit
V_{CC}	Supply Voltage		3.15	3.3	3.45	V
V_{IH}	Input High Voltage		2	-	5.25	V
V_{IL}	Input Low Voltage		-0.5	-	0.8	V
I_I	Input Leakage Current	$0 < V_{IN} < V_{CC}$	-	-	± 10	μA
V_{OH}	Output Voltage High	$I_{OUT} = 4 \text{ mA}$	2.4	-	-	V
V_{OL}	Output Low Voltage	$I_{OUT} = -4 \text{ mA}$	-	-	0.4	V
I_{OH}	Output Current High		-	-	4	mA
I_{OL}	Output Current Low		-	-	4	mA
C_{IN}	Input Pin Capacitance		-	-	10	pF
I_{SUSP}	Suspend Current		-	100	-	μA
I_{CC}	Supply Current					
	4 Active ports	Full speed Host, Full speed Devices	-	255	-	mA
		High speed Host, High speed Devices	-	460	-	mA
		High speed Host, Full speed Devices	-	395	-	mA
	2 Active Ports	Full speed Host, Full speed Devices	-	255	-	mA
		High speed Host, High speed Devices	-	415	-	mA
		High speed Host, Full speed Devices	-	380	-	mA
	No Active Ports	Full speed Host	-	255	-	mA
High speed Host		-	370	-	mA	
USB Transceiver						
Z_{HSDRV}	Driver Output Resistance		41	45	49	Ω
I_i	Input Leakage Current		-	± 0.1	± 5	μA
I_{OZ}	Three-state Output OFF-State Current		-	-	± 10	μA
V_{HSRS}	High speed Receiver Sensitivity Level		210	-	-	mV
T_{rff}	Full speed Frame Jitter		-	-	133	ns
Thermal Resistance						
T_{JA}	Theta Thermal Coefficient Junction to Ambient	E-Pad configuration in section at zero airflow	23.27	-	-	$^{\circ}C/W$

AC Electrical Characteristics

Both the upstream USB transceiver and all four downstream transceivers have passed the USB-IF USB 2.0 Electrical Certification Testing.

Table 17. Serial Peripheral Interface

Parameter	Description	Conditions	Min	Typ	Max	Unit
	Clock Rise/Fall Time		–	–	500	ns
	Clock Frequency		–	–	250	kHz
	Data Setup Time		50	–	–	ns
	Hold Time		100	–	–	ns
	Reset period		1.9	–	–	ms

Figure 6. Eye Diagram

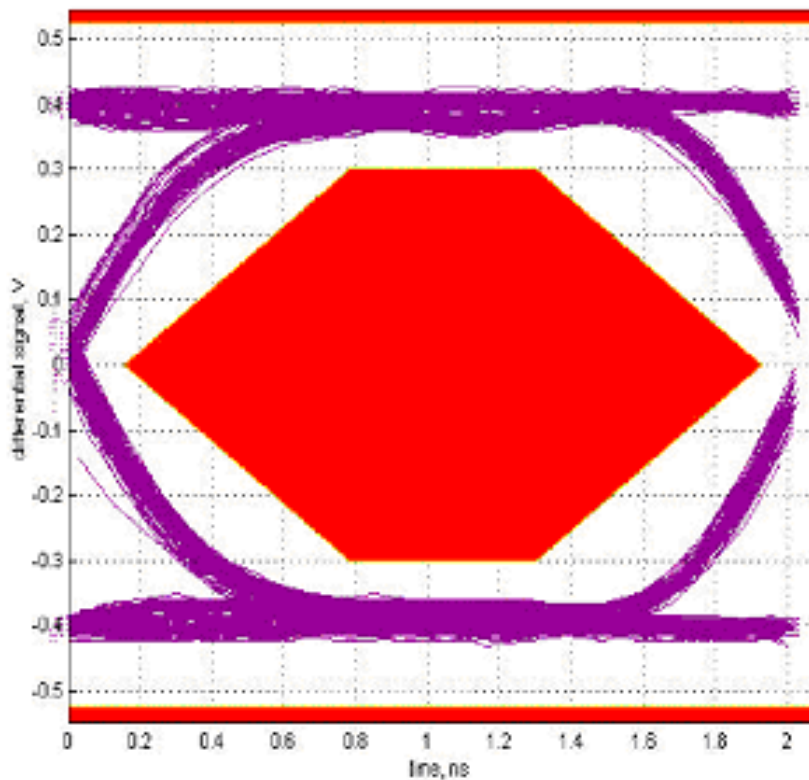

Ordering Information

Ordering Code	Package Type
CY7C65640A-LTXCKM	56-pin QFN Sawn type Pb-free Package
CY7C65640A-LTXC	56-pin QFN Sawn type Pb-free Package
CY7C65640A-LTXCT	56-pin QFN Sawn type Pb-free Package
CY4602	TetraHub USB 2.0 4 port Hub Reference Design Kit

Ordering Code Definitions

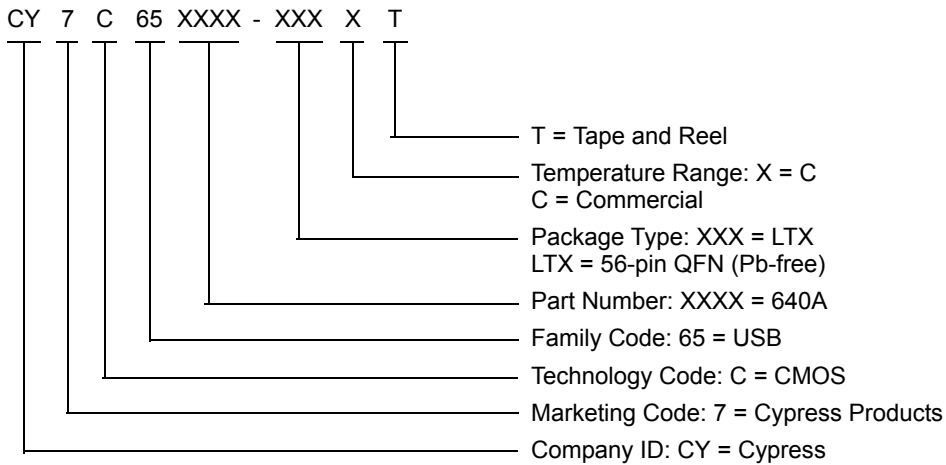

Package Diagram

The TetraHub is available in a space-saving 56-pin QFN (8 × 8 mm)

Figure 7. 56-pin QFN 8 × 8 mm

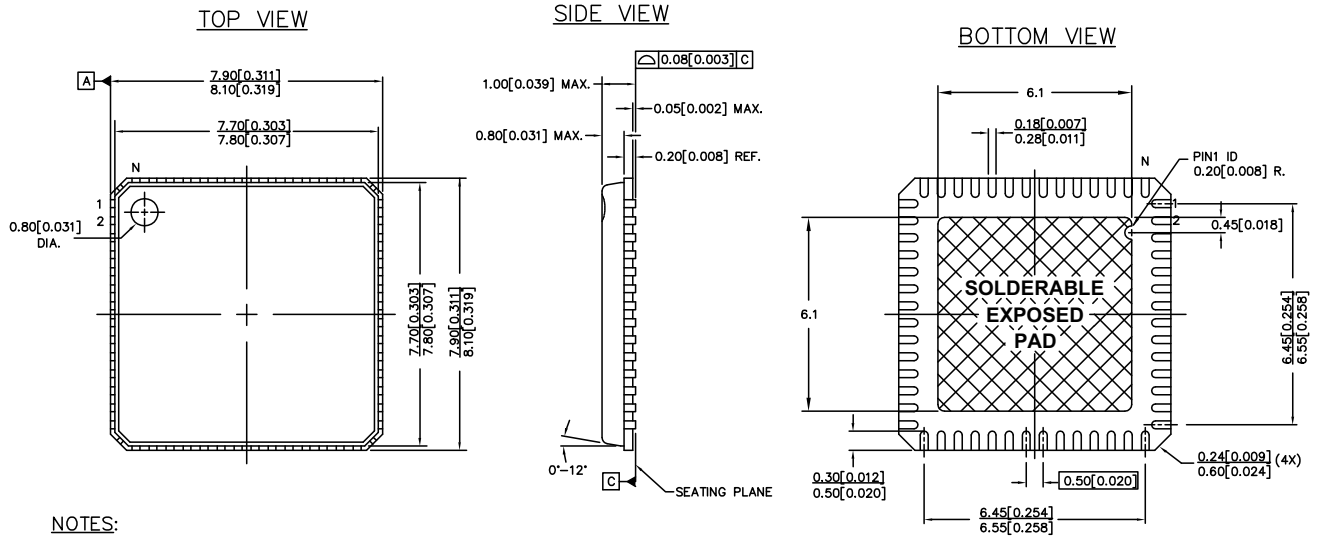

NOTES:

1.  HATCH AREA IS SOLDERABLE EXPOSED METAL.
2. REFERENCE JEDEC#: MO-220
3. PACKAGE WEIGHT: 0.162g
4. ALL DIMENSIONS ARE IN MM [MIN/MAX]
5. PACKAGE CODE

PART #	DESCRIPTION
LF56	STANDARD
LY56	PB-FREE

51-85144 *1

Figure 8. 56-pin Sawn QFN (8 × 8 × 1.0 mm)

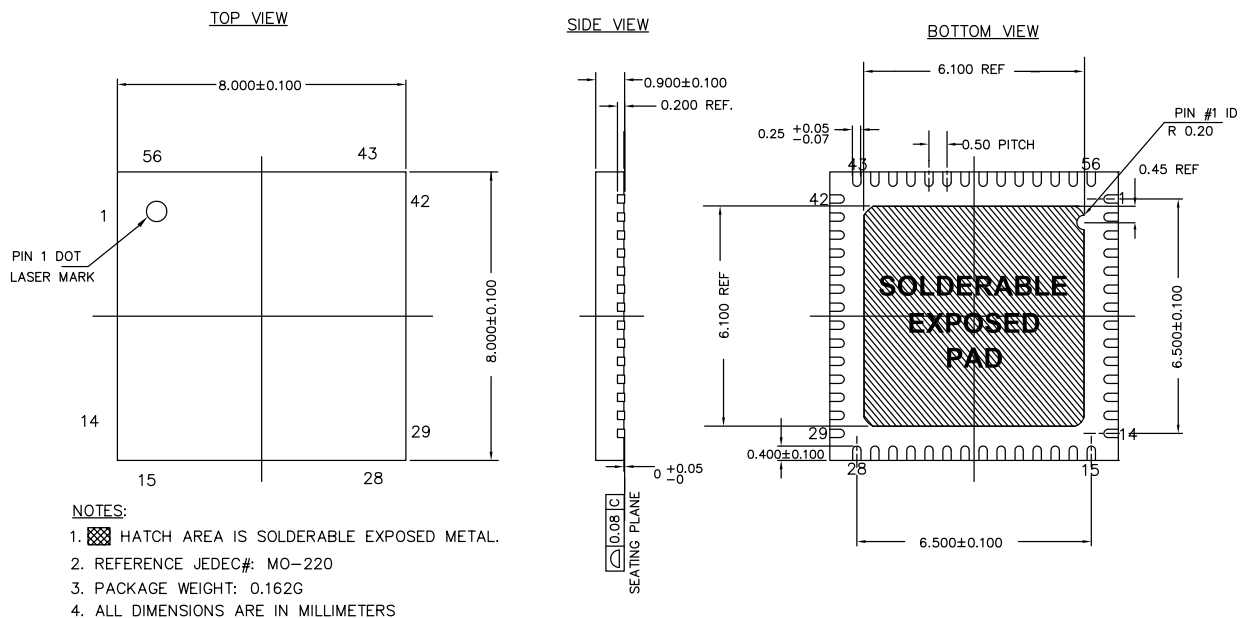

51-85187 *F

Note. The bottom metal pad size varies by product due to die size variable. If metal pad design or dimension are critical with your board designs, contact a Cypress Sales office to get the specific outline option.

Quad Flat Package No Leads (QFN) Package Design Notes

The QFN (Quad Flatpack No Leads), being a lead free package, the electrical contact of the part to the printed circuit board (PCB) is made by soldering the lands on the bottom surface of the package to the PCB. Hence special attention is required for the heat transfer area below the package to provide a good thermal bond to the circuit board. A Copper (Cu) fill should be designed into the PCB as a thermal pad under the package. Heat is transferred from the TetraHub through the device's metal paddle on the bottom side of the package. Heat from here is conducted to the PCB at the thermal pad. It is then conducted from the thermal pad to the PCB inner ground plane by a 5 × 5 array of via. A via is a plated through-hole in the PCB with a finished diameter of 13 mil. The QFN's metal die paddle must be soldered to the PCB's thermal pad. Solder mask is placed on the board top side over each via to resist solder flow into the via. The mask on the top side also minimizes outgassing during the solder reflow process.

Follow the layout guidelines provided in the PCB layout files accompanied with the CY4602 TetraHub Reference Design Kit. The information in this section was derived from the original application note by the package vendor. For further information on this package design, refer to the application note on Surface Mount Assembly of Amkor's MicroLeadFrame (MLF) Technology. You can find this on Amkor's website at this URL: http://www.amkor.com/products/notes_papers/MLF_AppNote. This application note provides detailed information on board mounting guidelines, soldering flow, rework process, and so on.

Figure 9 on page 23 displays a cross-sectional area underneath the package. The cross section is of only one via. The solder paste template needs to be designed to enable at least 50 percent solder coverage. The thickness of the solder paste template should be 5 mil. It is recommended that 'No Clean', type 3 solder paste is used for mounting the part. Nitrogen purge is recommended during reflow.

Figure 9. Cross section of Area Below the QFN Package

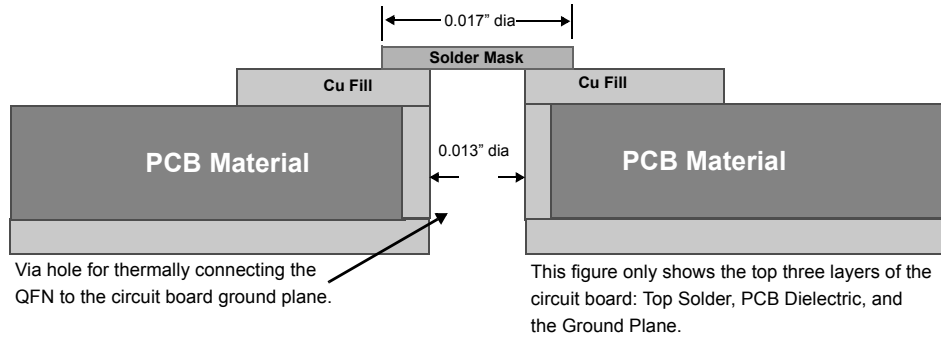

Figure 10 is a plot of the solder mask pattern and Figure 11 displays an X-Ray image of the assembly (darker areas indicate solder).

Figure 10. Plot of the Solder Mask (White Area)

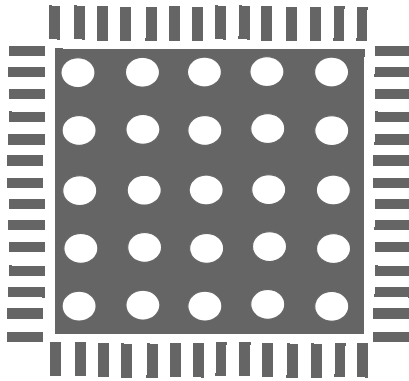
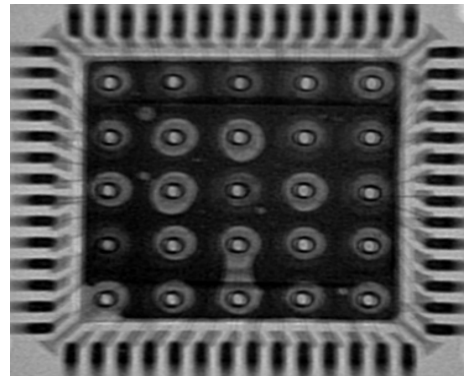

Figure 11. X-Ray Image of the Assembly



Document History Page

Document Title: CY7C65640A, TetraHub™ High Speed USB Hub Controller Document Number: 38-08019				
Revision	ECN	Orig. of Change	Submission Date	Description of Change
**	113506	BHA	04/25/02	New data sheet (Preliminary)
*A	116812	MON	08/15/02	Supply voltage range changed from 3.3V–3.6V to 3.15V–3.45 Added EPROM types that can be used with HX2 (p. 14) Added description of bit 7 of Byte 12 (Illegal Hub Descriptor) D2 Load (p. 15) Added high speed sensitivity level of receiver (p. 20) Added QFN package design notes (section 16.1)
*B	118518	MON	10/31/02	Fixed the Spec field in the Default Device Descriptor section 7.1 Fixed Interface Protocol field of the interface descriptor, section 7.3 Fixed Device Protocol field of the interface descriptor, section 7.7 Modified table 9-2, section 9.2 Added table 9-4, 9-5, section 9.2 Added table 4-1, 4-2, section 4.8 Added information on bits in wHubCharacteristics, section 7.8 Modified figure 16-1 in QFN package design notes, section 16.1 Included the eye diagram, section 14.4.2 Preliminary to Final
*C	121793	MON	12/09/02	Fixed the SPI clock Frequency to 250 KHz, section 14.4.1 Added information on the configuration of unused port pins, section 6.0 Added statement that no special power up procedure is required, section 6.0
*D	125275	MON	04/02/03	Changed the name of Bit 3 of Byte 12 of EEPROM for a 0xD2 load (section 8.2) from <i>BusPowered</i> to <i>Reserved</i> . Removed all indication to the misconception that the hub can support bus power. Added information as to which nibble of byte 8 in the EEPROM defines the active ports and which nibble defines the removable ports, section 8.2. Added further information on the BUSPOWER pin (pin 26) functionality in section 6.0.
*E	234272	MON	see ECN	Added part number for the lead free package (CY7C65640-LFXC), section 15.0 Changed the name of Bit 6 of Byte 12 of EEPROM for a 0xD2 load from <i>CompoundDevice</i> to <i>Unused</i> , section 8.2.
*F	285171	KKU	see ECN	Changed CY7C65640 to CY7C65640A and reformatted to new format
*G	308296	KKU	see ECN	Added reset period under AC characteristics. Removed compound device from features list. Updated section 7.1 DID from 0x0007 to 0x000B for rev E silicon.
*H	390258	KKU	see ECN	Added theta thermal coefficient junction to ambient (T_{JA}) to section 14.3
*I	522224	TEH	see ECN	Corrected typo in table 6-1. Changed downstream port 4 signal labels from [3] to [4]. Updated package diagram. Updated to new template.
*J	2657415	DPT / PYRS	02/10/09	Added package diagram spec 51-85187, updated package diagram spec 51-85144 and updated Ordering Information table
*K	2742387	DPT	07/22/09	Updated 56 QFN (sawn) package drawing
*L	2766203	DPT	09/18/09	Updated 56-Pin Sawn QFN package (Figure 8)
*M	2825358	RSKV / PYRS	12/10/09	Added Contents . Added 'Pb-free Package' for Sawn parts in the Ordering Information table.
*N	3149016	ODC	01/20/2011	Updated Operating Conditions . Updated Ordering Information and added Ordering Code Definitions . Updated to new template.

Document History Page *(continued)*

Document Title: CY7C65640A, TetraHub™ High Speed USB Hub Controller Document Number: 38-08019				
Revision	ECN	Orig. of Change	Submission Date	Description of Change
*O	3404993	AASI	10/13/2011	Moving tetrahub (CY7C65640A) to NRND. Adding watermark "Not recommended for new designs" on all pages of the datasheet.
*P	4566232	PRJI	11/10/2014	Updated Package Diagram : spec 51-85187 – Changed revision from *E to *F. Updated to new template. Completing Sunset Review.

Sales, Solutions, and Legal Information

Worldwide Sales and Design Support

Cypress maintains a worldwide network of offices, solution centers, manufacturer's representatives, and distributors. To find the office closest to you, visit us at [Cypress Locations](#).

Products

Automotive	cypress.com/go/automotive
Clocks & Buffers	cypress.com/go/clocks
Interface	cypress.com/go/interface
Lighting & Power Control	cypress.com/go/powerpsoc cypress.com/go/plc
Memory	cypress.com/go/memory
PSoC	cypress.com/go/psoc
Touch Sensing	cypress.com/go/touch
USB Controllers	cypress.com/go/USB
Wireless/RF	cypress.com/go/wireless

PSoC[®] Solutions

[psoc.cypress.com/solutions](#)
[PSoC 1](#) | [PSoC 3](#) | [PSoC 4](#) | [PSoC 5LP](#)

Cypress Developer Community

[Community](#) | [Forums](#) | [Blogs](#) | [Video](#) | [Training](#)

Technical Support

[cypress.com/go/support](#)

© Cypress Semiconductor Corporation, 2002-2014. The information contained herein is subject to change without notice. Cypress Semiconductor Corporation assumes no responsibility for the use of any circuitry other than circuitry embodied in a Cypress product. Nor does it convey or imply any license under patent or other rights. Cypress products are not warranted nor intended to be used for medical, life support, life saving, critical control or safety applications, unless pursuant to an express written agreement with Cypress. Furthermore, Cypress does not authorize its products for use as critical components in life-support systems where a malfunction or failure may reasonably be expected to result in significant injury to the user. The inclusion of Cypress products in life-support systems application implies that the manufacturer assumes all risk of such use and in doing so indemnifies Cypress against all charges.

Any Source Code (software and/or firmware) is owned by Cypress Semiconductor Corporation (Cypress) and is protected by and subject to worldwide patent protection (United States and foreign), United States copyright laws and international treaty provisions. Cypress hereby grants to licensee a personal, non-exclusive, non-transferable license to copy, use, modify, create derivative works of, and compile the Cypress Source Code and derivative works for the sole purpose of creating custom software and or firmware in support of licensee product to be used only in conjunction with a Cypress integrated circuit as specified in the applicable agreement. Any reproduction, modification, translation, compilation, or representation of this Source Code except as specified above is prohibited without the express written permission of Cypress.

Disclaimer: CYPRESS MAKES NO WARRANTY OF ANY KIND, EXPRESS OR IMPLIED, WITH REGARD TO THIS MATERIAL, INCLUDING, BUT NOT LIMITED TO, THE IMPLIED WARRANTIES OF MERCHANTABILITY AND FITNESS FOR A PARTICULAR PURPOSE. Cypress reserves the right to make changes without further notice to the materials described herein. Cypress does not assume any liability arising out of the application or use of any product or circuit described herein. Cypress does not authorize its products for use as critical components in life-support systems where a malfunction or failure may reasonably be expected to result in significant injury to the user. The inclusion of Cypress' product in a life-support systems application implies that the manufacturer assumes all risk of such use and in doing so indemnifies Cypress against all charges.

Use may be limited by and subject to the applicable Cypress software license agreement.