

**CZ-3814****125°C, Small and High Accuracy Coreless Current Sensor**

1. General Description

CZ-3814 is an open-type current sensor using Hall sensors, which outputs the analog voltage proportional to the AC/DC current. Group III-V compound semiconductor thin film is used as the Hall sensor, which enables the high-accuracy and high-speed current sensing. Coreless ultra-small surface mount package realizes the space-saving. CZ-3814 can be used up to operating ambient temperature 125°C. Existing coreless current sensors have an accuracy disadvantage from degradations caused by a disturbed magnetic field. CZ-3814 has a built-in stray magnetic field reduction function to suppress this effect.

2. Features

- Operating Ambient Temperature : -40~125°C
- Stray magnetic field reduction
- Maximum Primary Current : 40A_{rms}
- High-accuracy : 0.7%F.S. typ.
- Low variation and low temperature drift of zero-current output voltage : ±3mV typ.
- Low variation and low temperature drift of sensitivity : ±0.9% typ.
- Overcurrent Detection (Programable)
- Small-sized surface mount package
- Quite small primary conductor resistance : 0.3mΩ typ.
- Isolation Voltage : 3.0 kV_{rms} (AC50Hz, 60s)
- Certified with safety standards of IEC/UL60950, UL 1577 (certification pending)
- Fast response time : 2μs typ.
- Ratiometric output
- Operated by 5V single power supply



3. Applications

- AC motors
- DC motors
- UPS
- Power conditioners
- Air conditioners

And CZ-3814 is suitable for other automotive applications which are required isolation with small size and suppressing the heating.

4. Table of Contents

1.	<u>General Description</u>	1
2.	<u>Features</u>	1
3.	<u>Applications</u>	1
4.	<u>Table of Contents</u>	2
5.	<u>Block Diagram and Functions</u>	3
6.	<u>Pin Configurations and Functions</u>	4
7.	<u>Absolute Maximum Rating</u>	5
8.	<u>Recommended Operating Conditions</u>	5
9.	<u>Electric Characteristics</u>	7
10.	<u>Characteristic Definitions</u>	10
11.	<u>Recommended External Circuits</u>	13
12.	<u>Board Layout for Measuring Thermal Resistance</u>	14
13.	<u>Package</u>	15
14.	<u>Reliability Tests</u>	18
15.	<u>Precautions</u>	19
	<u>IMPORTANT NOTICE</u>	20

5. Block Diagram and Functions

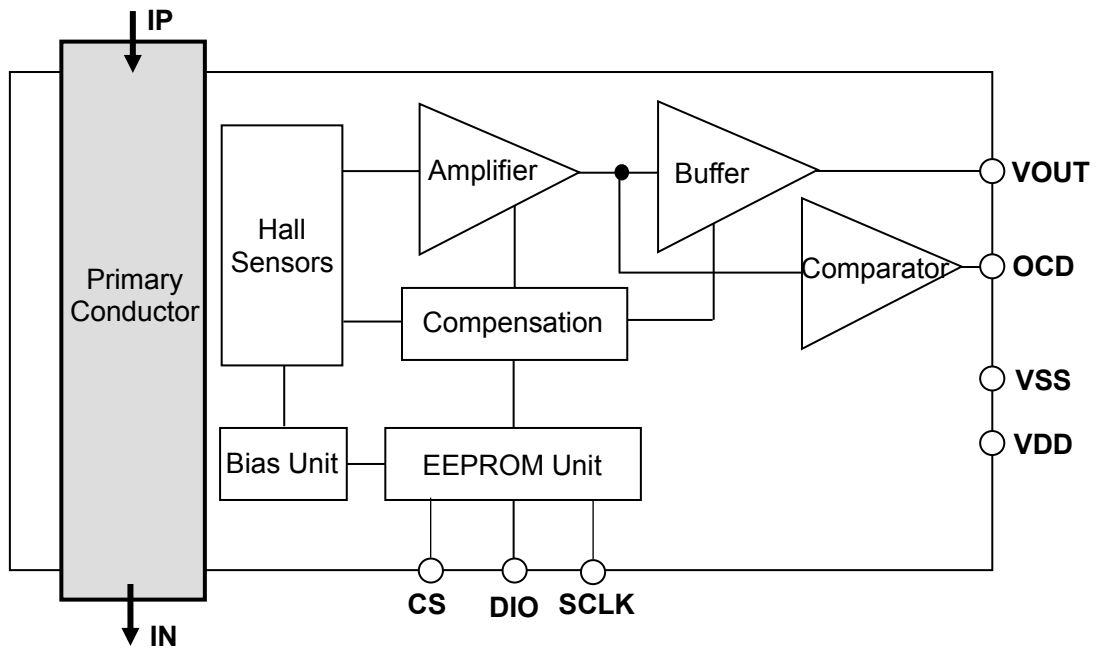

Figure 1. Block diagram of CZ-3814

Table 1. Explanation of circuit blocks

Circuit Block	Function
Primary Conductor	A device has the primary conductor built-in.
Hall Sensors	Hall elements which detect magnetic flux density generated from the measured current.
Amplifier	Amplifier of Hall elements' output.
Buffer	Output buffer with gain. This block outputs the voltage (V_{OUT}) proportional to the current applied to the primary conductor.
Compensation	Compensation circuit which adjusts the temperature drifts of sensitivity and zero-current voltage.
Comparator	Comparator circuit to detect overcurrent.
Bias Unit	Drive circuit for Hall elements.
EEPROM Unit	Non-volatile memory for setting adjustment parameters. The parameters are adjusted before the shipment.

6. Pin Configurations and Functions

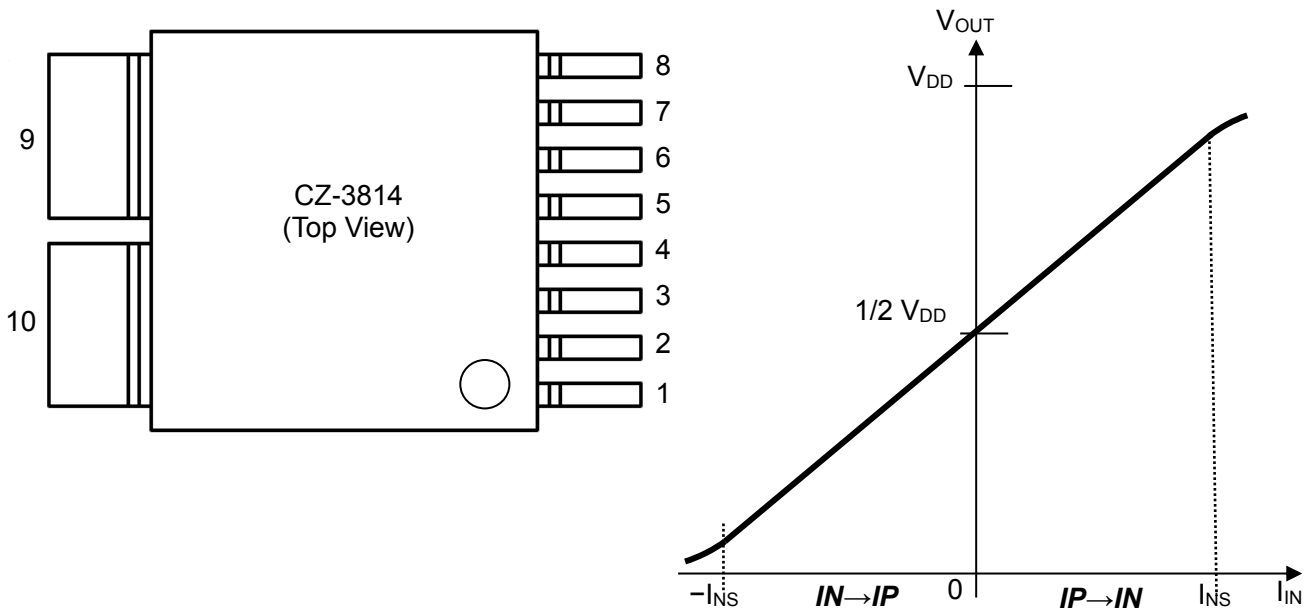

Figure 2. Pin configurations and typical output characteristics of CZ-3814

Table 2. Pin configuration and functions of CZ-3814

Pin No.	Pin Name	I/O	Pin Type	Function
1	VSS	GND	Power	Ground pin (GND)
2	OCD	O	Digital	Overcurrent detection pin. Normal output: "L", Over current detection: "H". Overcurrent detection function is initially off, and OCD output is high-impedance when shipped.
3	VDD	PWR	Power	Power supply pin
4	CS (Note1)	I	Digital	Chip select input pin for EEPROM access
5	VOUT	O	Analog	Sensor output pin
6	DIO (Note1)	I/O	Digital	Data input/output pin for EEPROM access
7	SCLK (Note1)	I	Digital	Clock input pin for EEPROM access
8	VSS	GND	Power	Ground pin (GND)
9	IN	I	-	Primary conductor pin (-)
10	IP	I	-	Primary conductor pin (+)

Note1. Recommended to open when not using the programming function.

7. Absolute Maximum Ratings

Table 3. Absolute maximum ratings

Parameter	Symbol	Min.	Max.	Units	Notes
Supply Voltage	V_{DD}	-0.3	6.5	V	VDD pin
Output Current 1	I_{OUT}	-10	10	mA	VOUT pin
Output Current 2	I_{OCD}	-10	10	mA	OCD pin
Signal Input Voltage	V_{INcom}	-0.3	$V_{DD}+0.3$	V	CS, DIO, SCLK pins
Junction Temperature	T_j	-40	150	°C	
Storage Temperature	T_{STG}	-55	150	°C	

WARNING: Operation at or beyond these limits may result in permanent damage to the device. Normal operation is not guaranteed at these extremes.

CS, SCLK and DIO signals should be input after the supply voltage is applied.

8. Recommended Operating Conditions

Table 4. Recommended operating conditions

Parameter	Symbol	Min.	Typ.	Max.	Units	Notes
Supply Voltage	V_{DD}	4.5	5.0	5.5	V	VDD pin
Output Load Capacitance 1	C_{LVOUT}			100	pF	Between VOUT pin and VSS pin
Output Load Capacitance 2	C_{LOCD}			50	pF	Between OCD pin and VSS pin
Output Load Current 1	I_{LVOUT}	-2		2	mA	VOUT pin
Output Load Current 2	I_{LOCD}	-200		200	μA	OCD pin
Maximum Primary Current(RMS) (Note2)	I_{RMSmax}			40	A_{rms}	Continuous DC value or RMS value which can be applied to primary conductor
Operating Ambient Temperature (Note2)	T_a	-40		125	°C	

WARNING: Electrical characteristics are not guaranteed when operated at or beyond these conditions.

Note2. Maximum Primary Current is specified by the derating curve. See Figure 3.

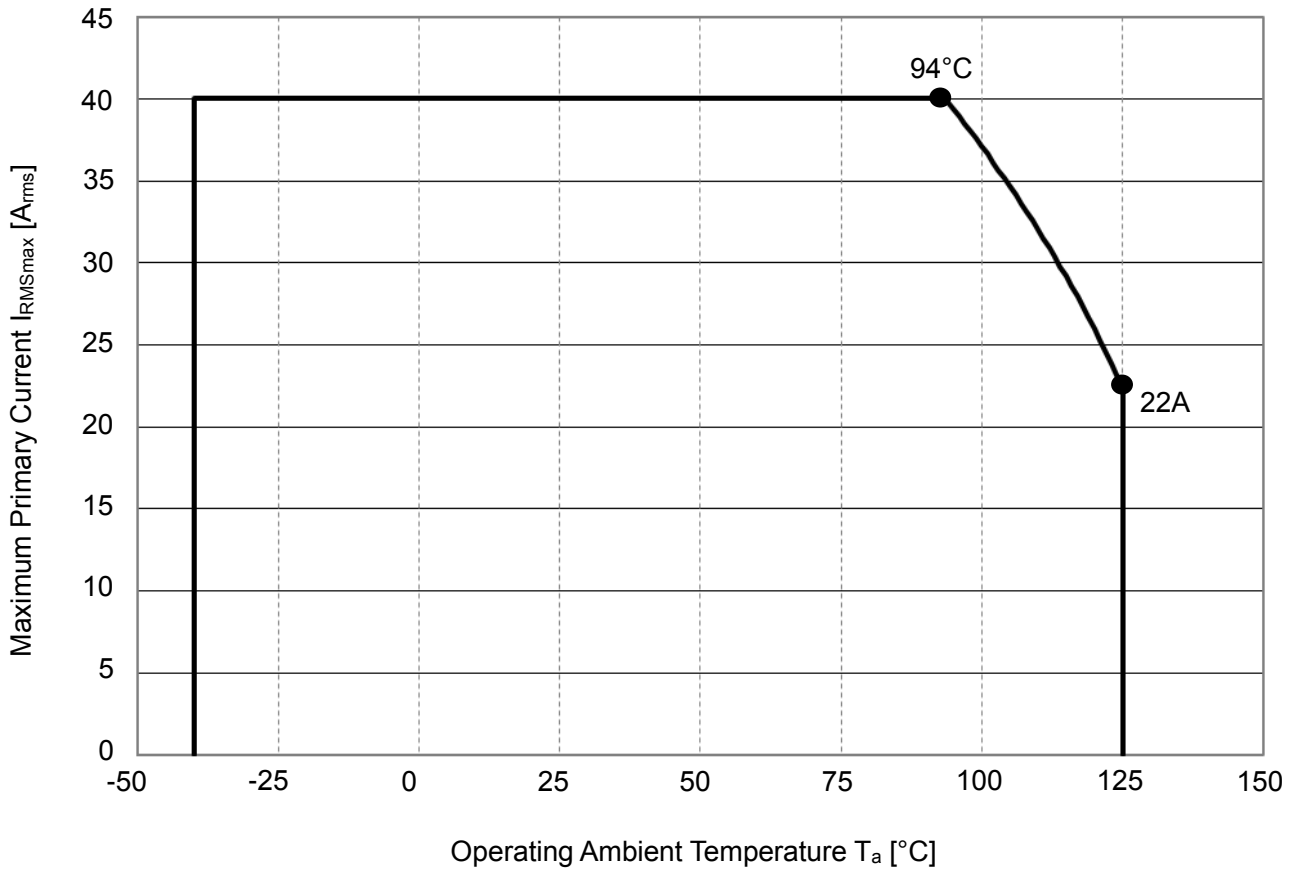

Conditions : Mounted on the board for measuring thermal resistance shown in chapter 12.
 Countermeasures such as cooling are not implemented. $V_{DD} = 5V$
 Cooling or thermal radiation will improve the derating curve above.

Figure 3. Primary current derating curve of CZ-3814

Table 5. Digital DC characteristics

Parameter	Symbol	Min.	Typ.	Max.	Units	Notes
Input Voltage	“H” level	V_{IH}	$0.8 \times V_{DD}$		V	CS,DIO, SCLK pins
	“L” level	V_{IL}		$0.2 \times V_{DD}$	V	
Output Voltage	“H” level $I_{LOCD} = -200\mu A$	V_{OH}	$0.9 \times V_{DD}$		V	OCD,DIO pins
	“L” level $I_{LOCD} = +200\mu A$	V_{OL}		$0.1 \times V_{DD}$	V	

9. Electrical Characteristics

Table 6. Electrical characteristics

Conditions (unless otherwise specified): $T_a = 25^\circ\text{C}$, $V_{DD} = 5.0\text{V}$

Parameter	Symbol	Conditions	Min.	Typ.	Max.	Units
Current Consumption	I_{DD}	$I_{IN} = 0\text{A}$, No loads		14		mA
Sensitivity (Note 3)	V_h	$I_{IN} = \pm 20\text{A}$, Current is applied within $500\mu\text{s}$	39.4	40.0	40.6	mV/A
Zero-Current Output Voltage (Note 3)	V_{of}	$I_{IN} = 0\text{A}$	$0.5 \times V_{DD} - 0.02$	$0.5 \times V_{DD}$	$0.5 \times V_{DD} + 0.02$	V
Linear Sensing Range (Note 4)	I_{NS}		-50.0		50.0	A
Overcurrent Detection Threshold Adjustable Range (Note 5)	I_{oc}	Overcurrent detection function enabled	76		154	% of I_{NS}
Overcurrent Detection Output Voltage	V_{ocd}	OCD pin	$0.9 \times V_{DD}$			V
Overcurrent Detection Response Time (Note 6)	t_{ocd}	$C_{LOCD} = 50\text{pF}$		1.4	2.5	μs
Overcurrent Detection Recovery Time (Note 6)	t_{rst}	$C_{LOCD} = 50\text{pF}$		3	20	μs
Overcurrent Detection Threshold Error	V_{oc}	Equivalent to Output Voltage	-100		100	mV
Output Saturation Voltage H	V_{satH}	$I_{out} = \pm 2.0\text{mA}$	$V_{DD} - 0.35$			V
Output Saturation Voltage L	V_{satL}	$I_{out} = \pm 2.0\text{mA}$			0.35	V
Linearity Error	ρ	$I_{IN} = \pm 20\text{A}$, Current is applied within $500\mu\text{s}$, $I_{out} = \pm 2.0\text{mA}$	-0.5		0.5	%F.S.
Rise Response Time (Note 6)	t_r	$I_{IN} 90\%$ to $V_{OUT} 90\%$, $C_{LVOUT} = 100\text{pF}$		2		μs
Fall Response Time (Note 6)	t_f	$I_{IN} 10\%$ to $V_{OUT} 10\%$, $C_{LVOUT} = 100\text{pF}$		2		μs
Bandwidth (Note 6)	f_T	-3dB, $C_{LVOUT} = 100\text{pF}$		210		kHz
Output Noise	V_{Nrms}	$I_{IN} = 0\text{A}$, 100Hz~300kHz		3		mV _{rms}
Ratiometricity Error of Sensitivity	V_{h-R}	$V_{DD} = 4.5\text{V} \sim 5.5\text{V}$	-1.0		1.0	%
Ratiometricity Error of Zero-Current Output Voltage	V_{of-R}	$V_{DD} = 4.85\text{V} \sim 5.15\text{V}$ $I_{IN} = 0\text{A}$	-0.3		0.3	%F.S.
Ratiometricity Error of Overcurrent Detection Threshold	V_{oc-R}	$V_{DD} = 4.5\text{V} \sim 5.5\text{V}$ Equivalent to Output Voltage	-3		3	%F.S.

Parameter	Symbol	Conditions	Min.	Typ.	Max.	Units
Power-on Time	t_{on}	$I_{IN} = 0A$, $V_{DD} 4.5V$ to V_{OUT} within $\pm 10\%$ of Convergence value			35	ms
Stray Magnetic Field Reduction	E_{bc}	Equivalent to Zero-Current Output Voltage -10mT < Stray Magnetic Field < 10mT		0.01		A/mT
Primary Conductor Resistance	R_P			0.3		m Ω
Isolation Voltage (Note 7)	V_{INS}	AC50Hz, 60s	3.0			kV _{rms}
Isolation Resistance (Note 4)	R_{INS}	DC1kV	500			M Ω

Table 7. Temperature drift characteristics (for reference)

Conditions (unless otherwise specified): $T_a = -40^\circ C \sim 125^\circ C$, $V_{DD} = 5.0V$

Parameter	Symbol	Conditions	Min.	Typ.	Max.	Units
Temperature Drift of Sensitivity (Note 8) (Note 9)	V_{h-d}	Variation ratio to $V_h = 40mV/A$		± 0.9		%
Temperature Drift of Zero-current Output Voltage (Note 8)	V_{of-d}	$I_{IN} = 0$, Variation value from V_{of} ($T_a = 25^\circ C$)		± 3		mV
Temperature Drift of Overcurrent Detection Threshold	V_{oc-d}	Including Overcurrent Detection Threshold Error $\pm 100mV$ ($T_a = 25^\circ C$)		± 200		mV
Total Accuracy (Note 8) (Note 9) (Note 10)	E_{total}	After correcting of zero-current output voltage ($T_a = 25^\circ C$)		0.7		%F.S.

Table 8. EEPROM characteristics

Conditions (unless otherwise specified): $V_{DD} = 5.0V$

Parameter	Symbol	Conditions	Min.	Typ.	Max.	Units
Endurance (Note 4)	E_{ED}	$T_j < 85^\circ C$			1000	times
Data Retention (Note 11)	E_{RT}	$T_j < 105^\circ C$	10			years

Note 3. These values can be drifted by long-term use or reflow process. Please see '14. Reliability Tests' for the reference of drift values.

Note 4. These parameters are guaranteed by design and not tested.

Note 5. Overcurrent detection function is off when shipped. Please refer to application note if using overcurrent detection function.

Note 6. These parameters are tested to input the equivalent current signal into IC in wafer condition. These characteristics after assembly are guaranteed by design.

Note 7. These parameters are tested for 1second at 3.6kV_{rms} in mass-production line for all devices.

Note 8. The typical value is defined as the “average value $\pm 1\sigma$ ” of the actual measurement result in a certain lot.

Note 9. Sensitivity condition : $I_{IN}=10A$, 10ms

Note 10. Linearity error condition : $I_{IN}=-10\sim 10 A$, 10ms

Note 11. This parameter is not guaranteed after rewriting more than 1000 times.

10. Characteristic Definitions

10.1 Sensitivity (V_h), Zero-current output voltage (V_{of}), and Linearity error (ρ) are defined as below:

Sensitivity (V_h) is defined as the slope of the approximate straight line calculated by the least square method, using the data of output voltage (V_{OUT}) when the primary current (I_{IN}) is swept within the range of linear sensing range (I_{NS}).

The output voltage (V_{OUT}) when the primary current (I_{IN}) is 0A is the Zero-Current Output Voltage (V_{of}).

Linearity error (ρ) is defined as the ratio of the maximum error voltage (V_d) to the full scale (F.S.), where V_d is the maximum difference between the output voltage (V_{OUT}) and the approximate straight line.

Definition formula is shown as below:

$$\rho = V_d / F.S. \times 100$$

Full scale (F.S.) is defined by $V_{satHmin} - V_{satLmax}$

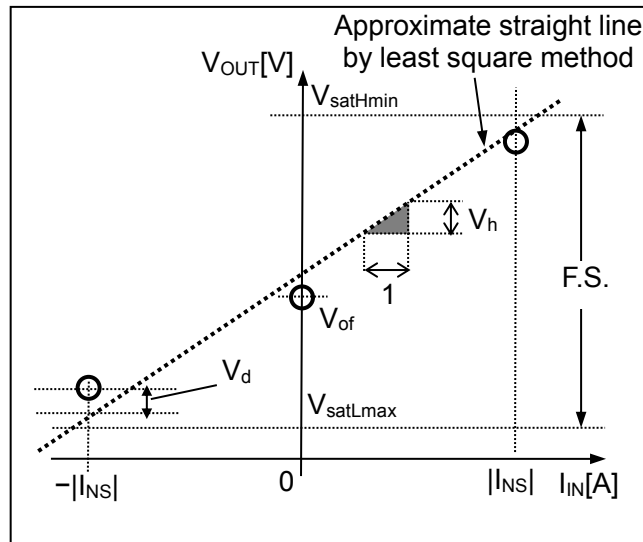

Figure 4. Output characteristics of CZ-3814

10.2 Ratiometric Error of Sensitivity (V_{h-R}) is defined as below:

$$V_{h-R} = 100 \times \frac{\left\{ \frac{V_h(V_{DD})}{V_h(5V)} - \frac{V_{DD}}{5} \right\}}{\frac{V_{DD}}{5}}$$

10.3 Ratiometric Error of Zero-Current Output Voltage (V_{of-R}) is defined as below:

$$V_{of-R} = 100 \times \frac{\left(V_{of}(V_{DD}) - \frac{V_{of}(5V) \times V_{DD}}{5} \right)}{F.S.}$$

10.4 Ratiometric Error of Overcurrent Detection Threshold (V_{oc-R}) is defined as below:

$$V_{oc-R} = 100 \times \frac{\left(V_{oc}(V_{DD}) - \frac{V_{oc}(5V) \times V_{DD}}{5} \right)}{F.S.}$$

10.5 Total Accuracy (E_{total}) is defined as below:

$$E_{total} = 100 \times \frac{V_{err}}{F.S.}$$

$$V_{err} = \left(|V_{of-d_{meas}}| + |I_{NS}| \times 40 \times \frac{|V_{h-d_{meas}}|}{100} \right) + |\rho_{meas}| \times F.S.$$

$V_{of-d_{meas}}$: Measured Temperature Drift of Zero-current Voltage [mV]
 $V_{h-d_{meas}}$: Measured Temperature Drift of Sensitivity [%]
 ρ_{meas} : Measured Linearity Error [%F.S.]

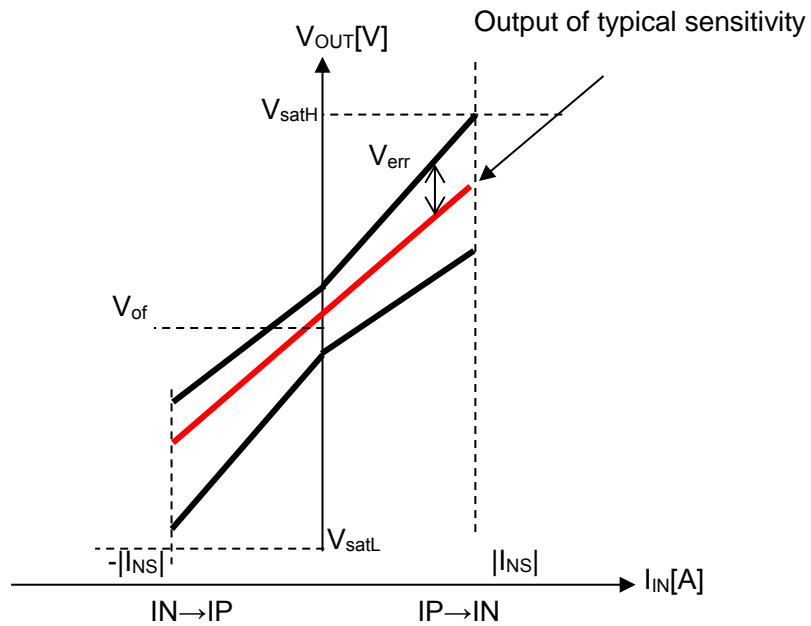

Figure 5. Total accuracy of CZ-3814

10.6 Rise Response Time t_r [μs] and Fall Response Time t_f [μs]

Rise response time (or fall response time) is defined as the time delay from the 90% (or 10%) of input primary current (I_{IN}) to the 90% (or 10%) of the V_{OUT} pin voltage (V_{OUT}) under the pulse input of primary current (Figure 6).

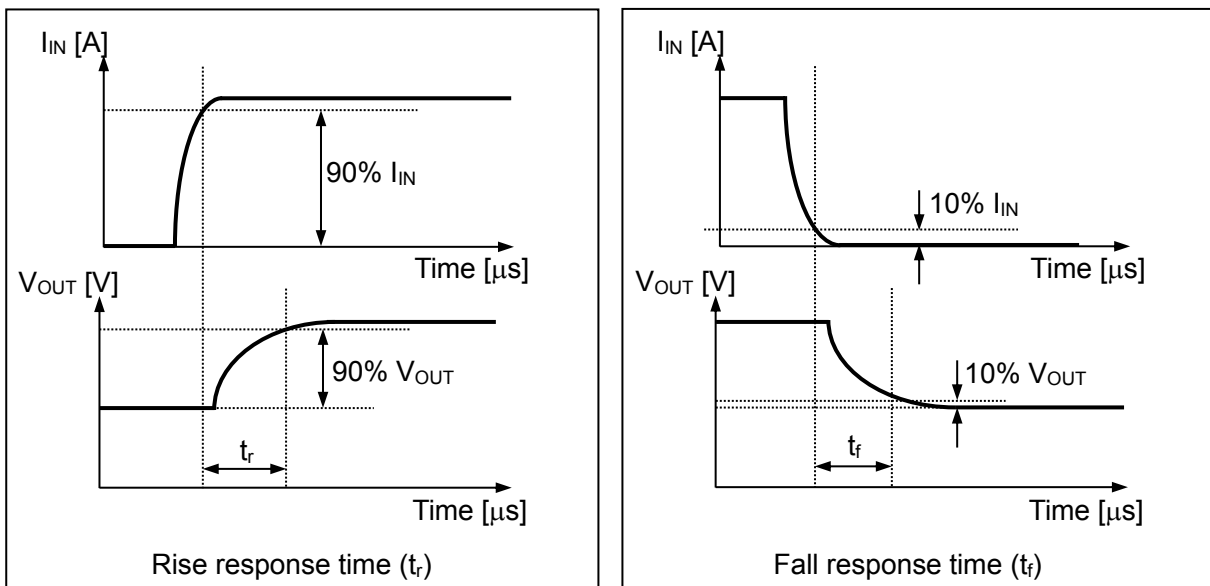
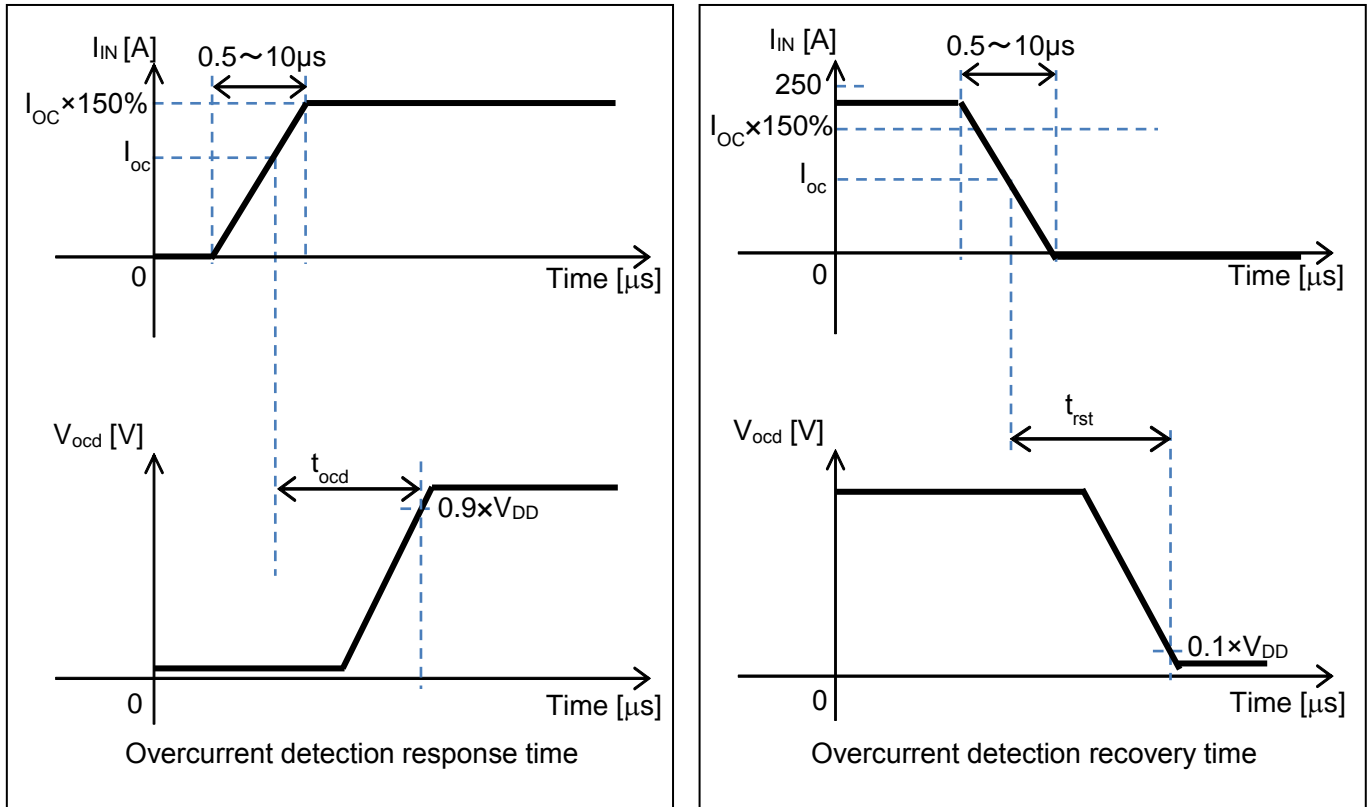

Figure 6. Definition of response time

10.7 Overcurrent Detection Response Time (t_{ocd}) and Overcurrent Detection Recovery Time (t_{rst}) are defined as below:

Overcurrent detection function can work both plus and minus direction current. The following case is applying plus direction current. Overcurrent detection response time (t_{ocd}) (or overcurrent detection recovery time (t_{rst})) is defined as the time from overcurrent detection threshold (I_{oc}) to $0.9 \times V_{DD}$ (or $0.1 \times V_{DD}$) of overcurrent detection voltage (V_{ocd}).



Conditions) Current starting point is the one point between $I_{oc} \times 150\%$ and 250[A].

Figure 7. Definition of overcurrent detection response time and overcurrent detection recovery time

11. Recommended External Circuits

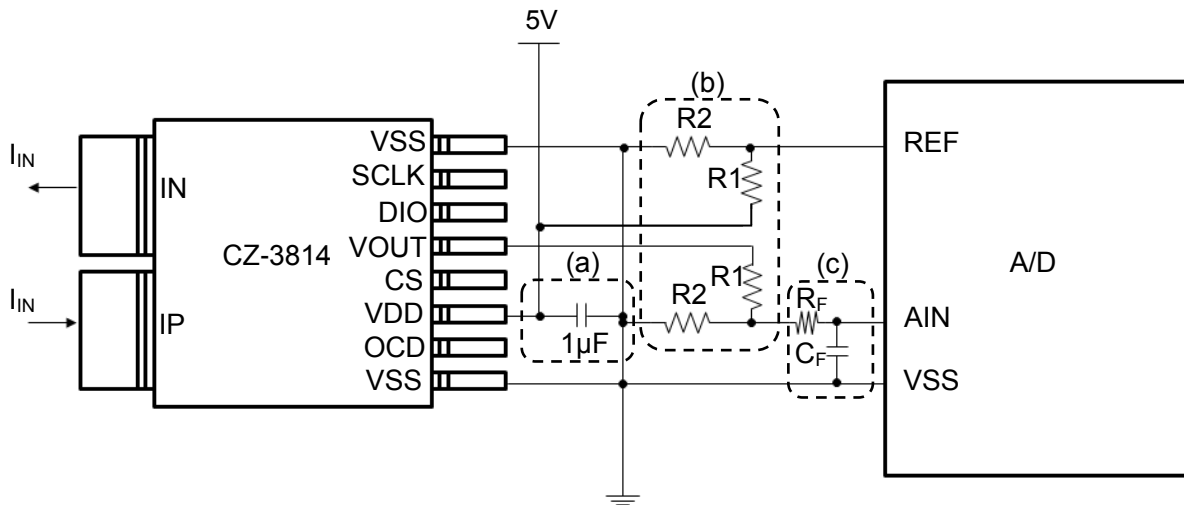

Figure 8. Recommended external circuits

- (a) $1\mu\text{F}$ bypass capacitor should be placed near by the VDD pin and VSS pin of CZ-3814.
- (b) CZ-3814 has the ratiometric output. By making the supply voltage of CZ-3814 and the reference voltage of A/D converter common, the A/D conversion error caused by the fluctuation of supply voltage is decreased. Voltage dividers (R1 and R2) are required if the reference voltage of A/D converter is less than +5V.

ex.) If the reference voltage of A/D converter is +3.3V which is its supply voltage level, $R1 = 20\text{k}\Omega$, $R2 = 39\text{k}\Omega$ are recommended. If the reference voltage of A/D converter is different from its supply voltage level, one more voltage divider is required.

- (c) Add a low-pass filter if it is necessary.

12. Board Layout for Measuring Thermal Resistance

Table 9. Board information

Board Size	43.2mm×35.6mm
Layer number	4
Copper layer thickness	70μm
Board Thickness	1.6mm

• Top pattern(1st)

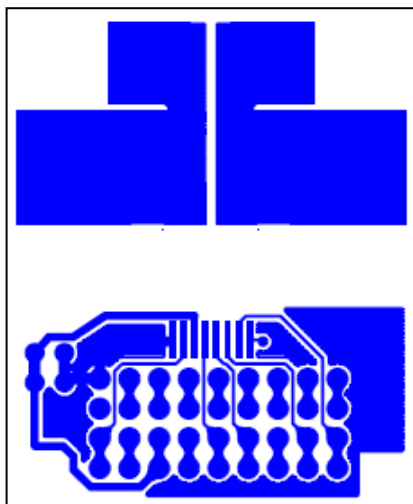

• Inner pattern(2nd/3rd VSS)

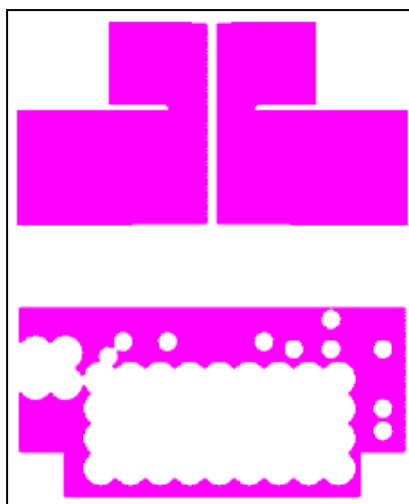

• Bottom pattern(4th)

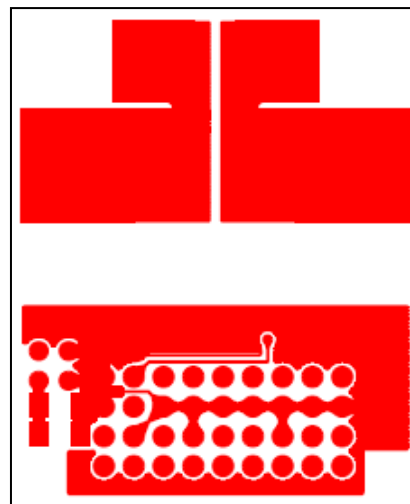
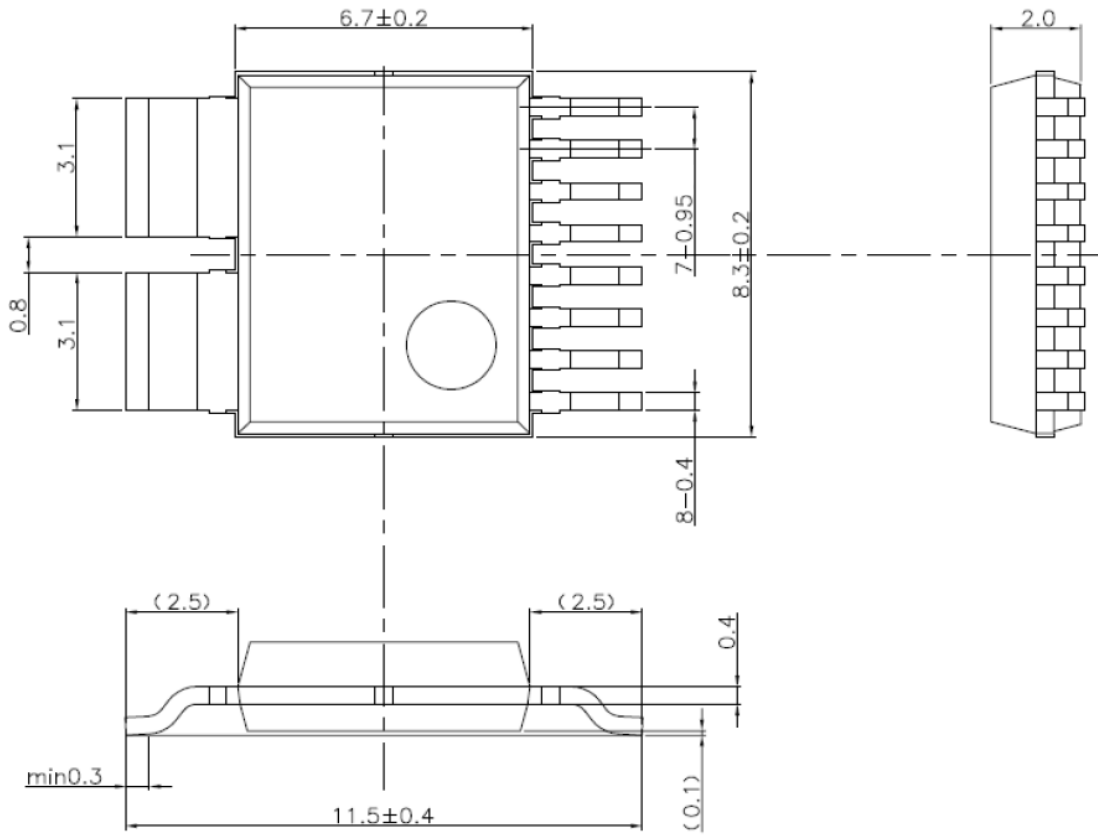

Figure 9. Board layout for measuring thermal resistance of CZ-3814

13. Package

13.1. Outline Dimensions



Unit: mm

The tolerances of dimensions without any mention are ± 0.1 mm.
 () is a reference values.

Figure 10. Outline dimensions of CZ-3814

Terminals: Cu
 Plating for Terminals: Sn-Bi
 RoHS compliant, halogen-free

Table 10. Package characteristics of CZ-3814

Parameter	Symbol	Min	Typ	Max	Units
Creepage distance	Cr	7.2			mm
Clearance distance	Cl	7.2			mm

*Flammability standard is V0. (According to UL94)

*Comparative tracking index (CTI) is 600V. Material Group is I .

13.2. Standards

- IEC/UL 60950-1 – Information Technology Equipment – Edition 2. (File No.E359197)
- CSA C22.2 NO. 60950-1-07 – Information Technology Equipment – Edition 2. (File No. E359197)

13.3. Recommended Pad Dimensions

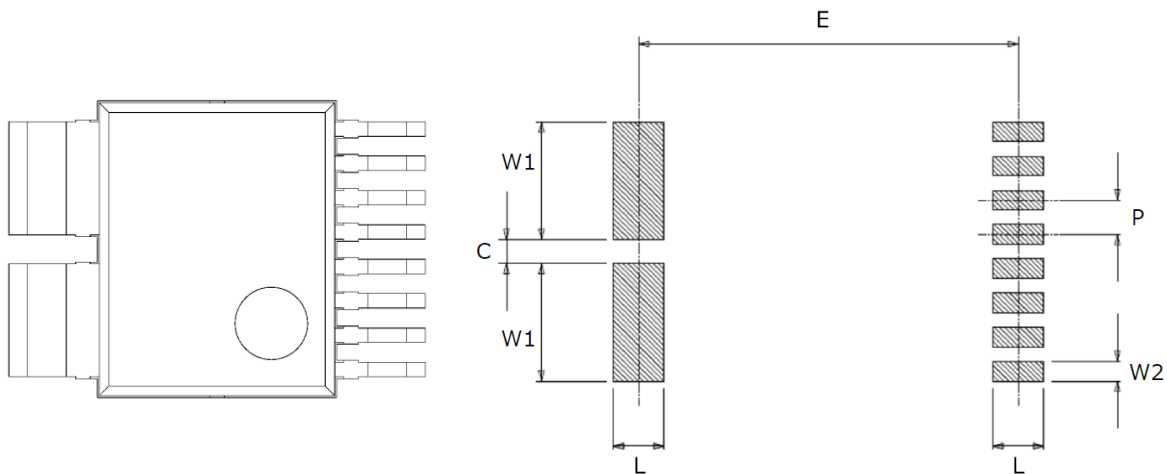

Figure11. Recommended pad pattern

Table 11. Recommended pad dimensions

L	1.42
E	10.58
W1	3.3
W2	0.54
C	0.66
P	0.95

Unit:mm

If two or more trace layers are used as the current paths, please make enough number of through-holes to flow current between the trace layers. In order to make heat dissipation better, it is recommended that Pad on Via should be provided on the pad of the primary conductor.

13.4. Marking

Production information is printed on the package surface by laser marking. Markings consist of 11 characters excluding AKM logo.

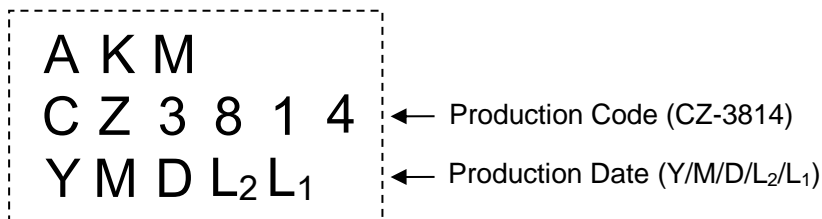

Figure 12. Markings of CZ-3814

Table 12. Production date code table

Year(Y)		Month(M)		Day(D)		Lot number		
Character	Year	Character	Month	Character	Day	Character (L ₂)	Character (L ₁)	Lot number
5	2015	C	January	1	1	0	1	01
6	2016	D	February	2	2	0	2	02
7	2017	E	March	3	3	0	3	03
8	2018	F	April	4	4	0	4	04
9	2019	G	May	5	5	0	5	05
A	2020	H	June	6	6	:	:	:
B	2021	J	July	7	7	:	:	:
C	2022	K	August	8	8	6	7	67
D	2023	L	September	9	9	6	8	68
E	2024	M	October	0	10	6	9	69
F	2025	N	November	A	11	7	0	70
G	2026	P	December	B	12	7	1	71
H	2027			C	13	:	:	:
J	2028			D	14			
K	2029			E	15			
L	2030			F	16			
N	2031			G	17			
P	2032			H	18			
R	2033			J	19			
S	2034			K	20			
T	2035			L	21			
U	2036			N	22			
V	2037			P	23			
W	2038			R	24			
X	2039			S	25			
0	2040			T	26			
1	2041			U	27			
2	2042			V	28			
3	2043			W	29			
4	2044			X	30			
				Y	31			

14. Reliability Tests

Table 13. Test parameters and conditions of reliability tests

No.	Test Parameter	Test Conditions	n	Test Time
1	Temperature Humidity Bias Test	【JEITA EIAJ ED-4701 102】 T _a =85°C, 85%RH, continuous operation	22	1000h
2	High Temperature Bias Test	【JEITA EIAJ ED-4701 101】 T _a =150°C, continuous operation	22	1000h
3	High Temperature Storage Test	【JEITA EIAJ ED-4701 201】 T _a =150°C	22	1000h
4	Low Temperature Operating Test	T _a =-40°C, continuous operation	22	1000h
5	Temperature Cycle Test	【JEITA EIAJ ED-4701 105】 -65°C ↔ +150°C 30min. ↔ 30min.	22	200 cycles

Tested samples are pretreated as below before each reliability test:

Desiccation: 125°C / 24h → Moisture Absorption: 30°C / 70%RH / 192h

→ Reflow: 3 times (JEDEC MSL3)

Criteria:

Products whose drifts between before pretreated and after the reliability tests do not exceed the values below are considered to be in spec.

Sensitivity V _h (T _a =25°C)	: Within ±2%
Zero-Current Output Voltage V _{of} (T _a =25°C)	: Within ±20mV
EEPROM data	: Unchanged

15. Precautions

<Storage Environment>

Products should be stored at an appropriate temperature and humidity (5 to 35°C, 40 to 85%RH) without direct sunlight. It is recommended to use the products within 1 weeks since packing was opened. Keep products away from chlorine and corrosive gas. When stored in an inappropriate environment, it can affect the product properties.

<Long-term Storage>

Long-term storage may result in poor lead solderability and degraded electrical performance even under proper conditions. For those parts, which stored long-term should be checked as for solderability before it is used.

For storage longer than 1 year, it is recommended to store in nitrogen atmosphere. Oxygen of atmosphere oxidizes leads of products, and lead solderability get worse.

<Other Precautions>

- 1) This product should not be used under the environment with corrosive gas including chlorine or sulfur.
- 2) This product is lead (Pb) free. All leads are plated with Sn-Bi. Do not store this product alone in high temperature and high humidity environment. Moreover, this product should be mounted on substrate within six months after delivery.
- 3) This product is damaged when it is used on the following conditions:
 - Supply voltage is applied in the opposite way.
 - Overvoltage which is larger than the value indicated in the specification.
- 4) This product will be damaged if it is used for a long time with the current (effective current) which exceeds the current rating. Careful attention must be paid so that maximum effective current is smaller than current rating.
- 5) The characteristics can be changed by the influences of nearby current and magnetic field and electric field. Please make sure of the mounting position.

As this product contains gallium arsenide, observe the following procedures for safety.

- 1) Do not alter the form of this product into a gas, powder, liquid, through burning, crushing, or chemical processing.
- 2) Observe laws and company regulations when discarding this product.

IMPORTANT NOTICE

0. Asahi Kasei Microdevices Corporation (“AKM”) reserves the right to make changes to the information contained in this document without notice. When you consider any use or application of AKM product stipulated in this document (“Product”), please make inquiries the sales office of AKM or authorized distributors as to current status of the Products.
1. All information included in this document are provided only to illustrate the operation and application examples of AKM Products. AKM neither makes warranties or representations with respect to the accuracy or completeness of the information contained in this document nor grants any license to any intellectual property rights or any other rights of AKM or any third party with respect to the information in this document. You are fully responsible for use of such information contained in this document in your product design or applications. **AKM ASSUMES NO LIABILITY FOR ANY LOSSES INCURRED BY YOU OR THIRD PARTIES ARISING FROM THE USE OF SUCH INFORMATION IN YOUR PRODUCT DESIGN OR APPLICATIONS.**
2. The Product is neither intended nor warranted for use in equipment or systems that require extraordinarily high levels of quality and/or reliability and/or a malfunction or failure of which may cause loss of human life, bodily injury, serious property damage or serious public impact, including but not limited to, equipment used in nuclear facilities, equipment used in the aerospace industry, medical equipment, equipment used for automobiles, trains, ships and other transportation, traffic signaling equipment, equipment used to control combustions or explosions, safety devices, elevators and escalators, devices related to electric power, and equipment used in finance-related fields. Do not use Product for the above use unless specifically agreed by AKM in writing.
3. Though AKM works continually to improve the Product’s quality and reliability, you are responsible for complying with safety standards and for providing adequate designs and safeguards for your hardware, software and systems which minimize risk and avoid situations in which a malfunction or failure of the Product could cause loss of human life, bodily injury or damage to property, including data loss or corruption.
4. Do not use or otherwise make available the Product or related technology or any information contained in this document for any military purposes, including without limitation, for the design, development, use, stockpiling or manufacturing of nuclear, chemical, or biological weapons or missile technology products (mass destruction weapons). When exporting the Products or related technology or any information contained in this document, you should comply with the applicable export control laws and regulations and follow the procedures required by such laws and regulations. The Products and related technology may not be used for or incorporated into any products or systems whose manufacture, use, or sale is prohibited under any applicable domestic or foreign laws or regulations.
5. Please contact AKM sales representative for details as to environmental matters such as the RoHS compatibility of the Product. Please use the Product in compliance with all applicable laws and regulations that regulate the inclusion or use of controlled substances, including without limitation, the EU RoHS Directive. AKM assumes no liability for damages or losses occurring as a result of noncompliance with applicable laws and regulations.
6. Resale of the Product with provisions different from the statement and/or technical features set forth in this document shall immediately void any warranty granted by AKM for the Product and shall not create or extend in any manner whatsoever, any liability of AKM.
7. This document may not be reproduced or duplicated, in any form, in whole or in part, without prior written consent of AKM.

Rev.1