

MECHANICAL DATA

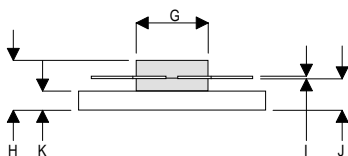
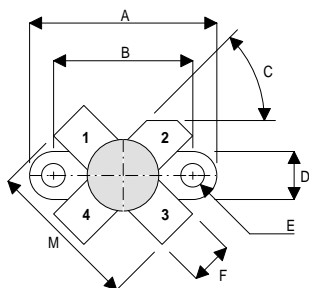

DA

PIN 1 SOURCE PIN 2 DRAIN
 PIN 3 SOURCE PIN 4 GATE

DIM	mm	Tol.	Inches	Tol.
A	24.76	0.13	0.975	0.005
B	18.42	0.13	0.725	0.005
C	45°	5°	45°	5°
D	6.35	0.13	0.25	0.005
E	3.17	0.13	0.125 DIA	0.005
F	5.71	0.13	0.225	0.005
G	9.52	0.13	0.375	0.005
H	6.60	REF	0.260	REF
I	0.13	0.02	0.005	0.001
J	4.32	0.13	0.170	0.005
K	2.54	0.13	0.100	0.005
M	20.32	0.25	0.800	0.010

**GOLD METALLISED
 MULTI-PURPOSE SILICON
 DMOS RF FET
 40W – 28V – 175MHz
 SINGLE ENDED**

FEATURES

- SIMPLIFIED AMPLIFIER DESIGN
- SUITABLE FOR BROAD BAND APPLICATIONS
- LOW C_{rss}
- SIMPLE BIAS CIRCUITS
- LOW NOISE
- HIGH GAIN – 16 dB MINIMUM

APPLICATIONS

- HF/VHF/UHF COMMUNICATIONS
 from 1 MHz to 175 MHz

ABSOLUTE MAXIMUM RATINGS ($T_{case} = 25^{\circ}C$ unless otherwise stated)

P_D	Power Dissipation	87W
BV_{DSS}	Drain – Source Breakdown Voltage	70V
BV_{GSS}	Gate – Source Breakdown Voltage	$\pm 20V$
$I_{D(sat)}$	Drain Current	10A
T_{stg}	Storage Temperature	-65 to $150^{\circ}C$
T_j	Maximum Operating Junction Temperature	$200^{\circ}C$

Semelab Plc reserves the right to change test conditions, parameter limits and package dimensions without notice. Information furnished by Semelab is believed to be both accurate and reliable at the time of going to press. However Semelab assumes no responsibility for any errors or omissions discovered in its use. Semelab encourages customers to verify that datasheets are current before placing orders.

ELECTRICAL CHARACTERISTICS (T_{case} = 25°C unless otherwise stated)

Parameter	Test Conditions	Min.	Typ.	Max.	Unit
B _V DSS Drain–Source Breakdown Voltage	V _{GS} = 0 I _D = 100mA	70			V
I _D DSS Zero Gate Voltage Drain Current	V _{DS} = 28V V _{GS} = 0			2	mA
I _G DSS Gate Leakage Current	V _{GS} = 20V V _{DS} = 0			1	μA
V _{GS(th)} Gate Threshold Voltage*	I _D = 10mA V _{DS} = V _{GS}	1		7	V
g _{fs} Forward Transconductance*	V _{DS} = 10V I _D = 2A	1.6			S
G _{PS} Common Source Power Gain	P _O = 40W	16			dB
η Drain Efficiency	V _{DS} = 28V I _{DQ} = 0.2A	50			%
VSWR Load Mismatch Tolerance	f = 175MHz	20:1			—
C _{iss} Input Capacitance	V _{DS} = 28V V _{GS} = -5V f = 1MHz			120	pF
C _{oss} Output Capacitance	V _{DS} = 28V V _{GS} = 0 f = 1MHz			60	pF
C _{rss} Reverse Transfer Capacitance	V _{DS} = 28V V _{GS} = 0 f = 1MHz			5	pF

* Pulse Test: Pulse Duration = 300 μs , Duty Cycle ≤ 2%

HAZARDOUS MATERIAL WARNING

The ceramic portion of the device between leads and metal flange is beryllium oxide. Beryllium oxide dust is highly toxic and care must be taken during handling and mounting to avoid damage to this area.

THESE DEVICES MUST NEVER BE THROWN AWAY WITH GENERAL INDUSTRIAL OR DOMESTIC WASTE.

THERMAL DATA

R _{THj-case}	Thermal Resistance Junction – Case	Max. 2.0°C / W
-----------------------	------------------------------------	----------------

Semelab Plc reserves the right to change test conditions, parameter limits and package dimensions without notice. Information furnished by Semelab is believed to be both accurate and reliable at the time of going to press. However Semelab assumes no responsibility for any errors or omissions discovered in its use. Semelab encourages customers to verify that datasheets are current before placing orders.

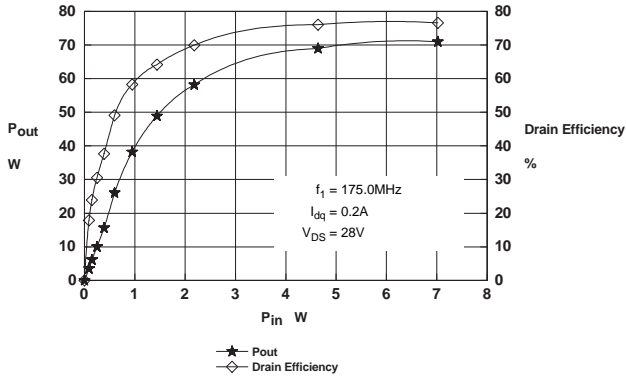

Figure 1 – Power Output and Efficiency vs. Power Input.

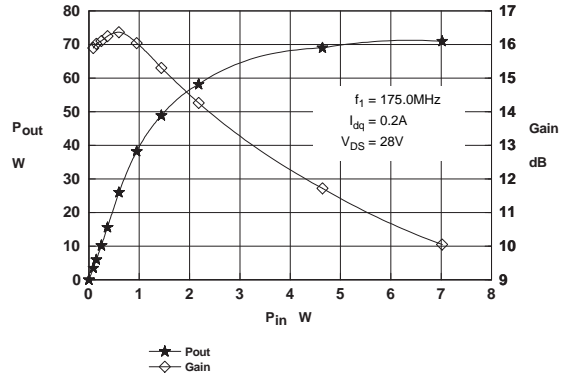

Figure 2 – Power Output & Gain vs. Power Input.

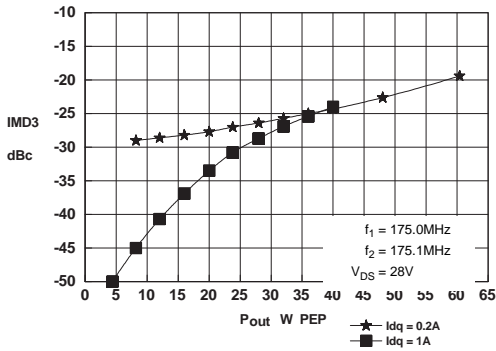

Figure 3 – IMD vs. Output Power.

D1002UK OPTIMUM SOURCE AND LOAD IMPEDANCE

Frequency MHz	Z _S Ω	Z _L Ω
175MHz	3.8 + j6.5	4.6 + j0.4

Typical S Parameters

! Vds=28V Idq=0.2A
MHZ S MA R 50

!Freq MHz	S11		S21		S12		S22	
	mag	ang	mag	ang	mag	ang	mag	ang
50	0.76	-144	15.6	86	0.026	1	0.58	-119
100	0.79	-155	7.1	61	0.021	-9	0.66	-132
150	0.84	-163	4.2	43	0.012	-3	0.74	-144
200	0.87	-169	2.7	33	0.009	47	0.81	-154
250	0.90	-176	1.9	23	0.016	76	0.85	-163
300	0.92	177	1.5	20	0.025	87	0.88	-172
350	0.94	170	1.1	11	0.033	85	0.91	-180
400	0.96	163	0.9	6	0.046	82	0.94	172
450	0.97	156	0.7	-2	0.051	78	0.96	165
500	0.98	150	0.6	-8	0.062	76	0.98	157
550	0.98	144	0.4	-12	0.068	74	0.98	152
600	0.98	141	0.4	-14	0.078	67	0.98	148

Semelab Plc reserves the right to change test conditions, parameter limits and package dimensions without notice. Information furnished by Semelab is believed to be both accurate and reliable at the time of going to press. However Semelab assumes no responsibility for any errors or omissions discovered in its use. Semelab encourages customers to verify that datasheets are current before placing orders.

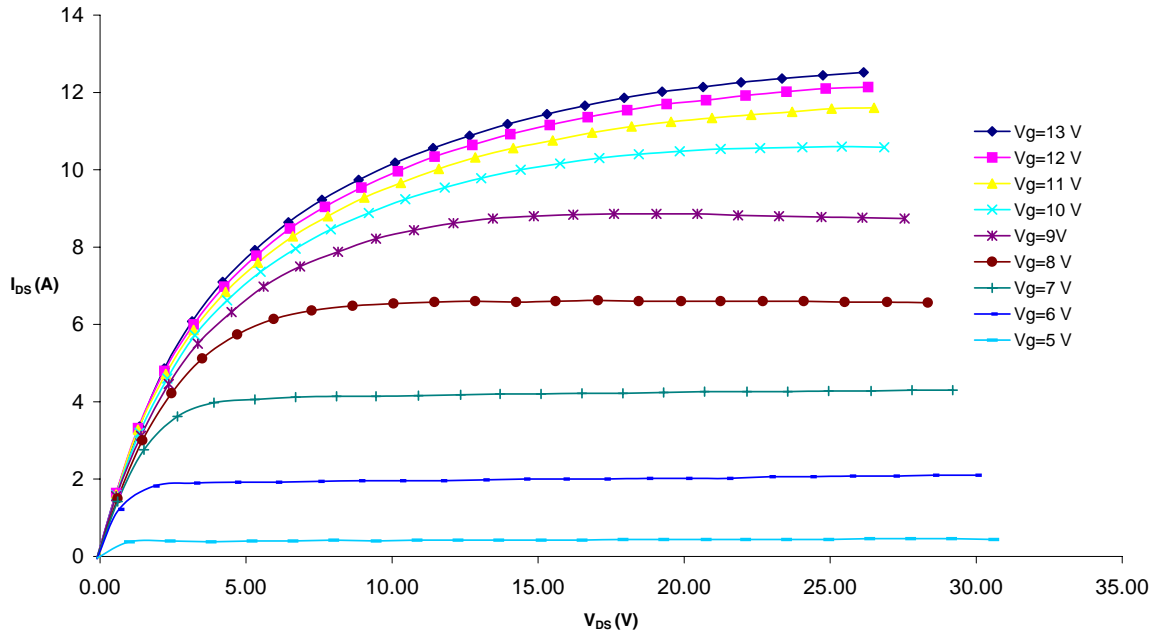

Figure 4 – Typical IV Characteristics.

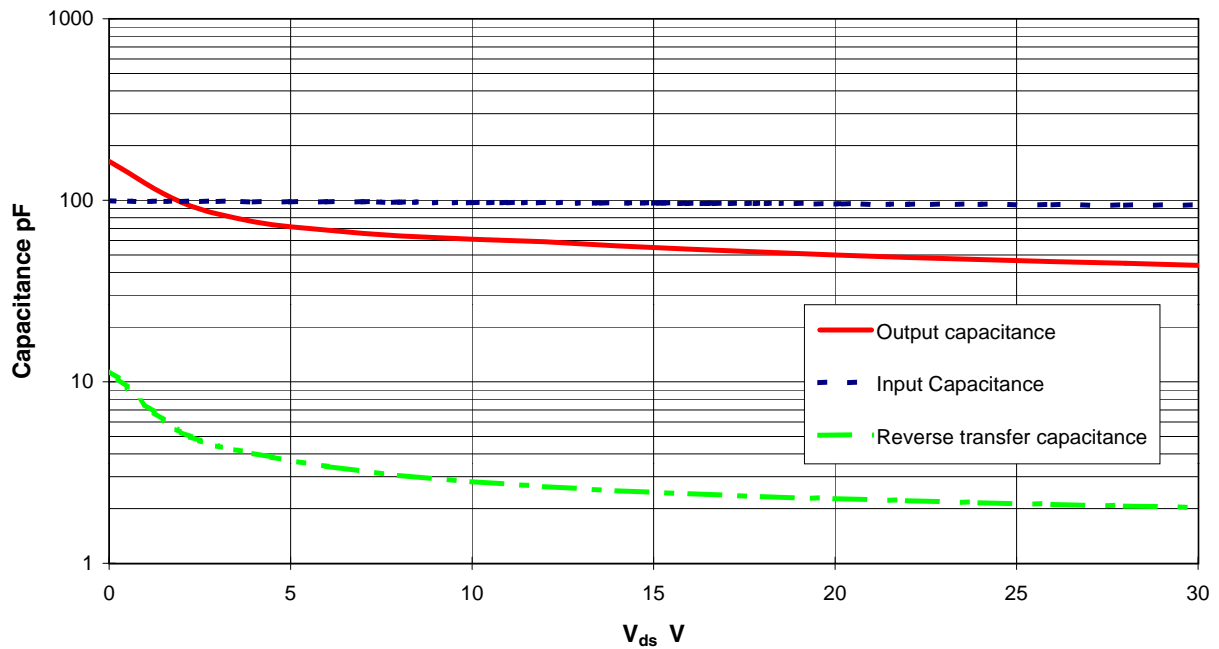
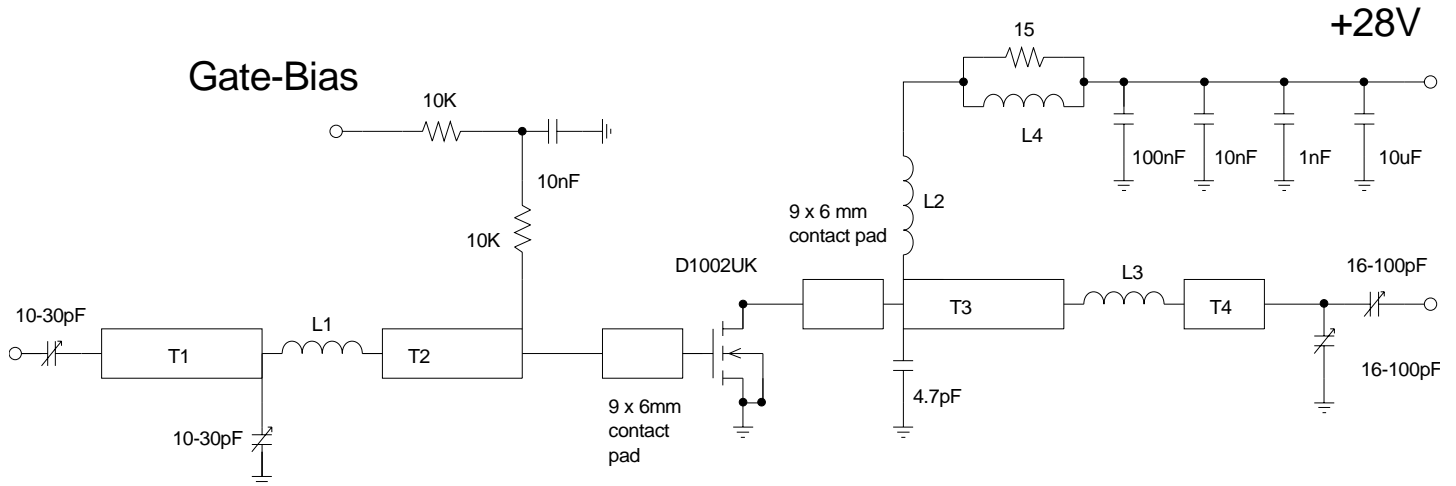

Figure 5 – Typical CV Characteristics.

Semelab Plc reserves the right to change test conditions, parameter limits and package dimensions without notice. Information furnished by Semelab is believed to be both accurate and reliable at the time of going to press. However Semelab assumes no responsibility for any errors or omissions discovered in its use. Semelab encourages customers to verify that datasheets are current before placing orders.



D1002UK 175MHz TEST FIXTURE

Substrate 1.6mm PTFE/glass, Er=2.5
All microstrip lines W=4.4mm

T1	10mm	L1	1.5 turns 22swg enamelled copper wire, 6mm i.d.
T2	13mm	L2	10 turns 19swg enamelled copper wire, 6mm i.d.
T3	12mm	L3	1.5 turns 22swg enamelled copper wire, 6mm i.d.
T4	4mm	L4	13.5 turns 19swg enamelled copper wire on Siemens B64920A618X830 ferrite core

Semelab Plc reserves the right to change test conditions, parameter limits and package dimensions without notice. Information furnished by Semelab is believed to be both accurate and reliable at the time of going to press. However Semelab assumes no responsibility for any errors or omissions discovered in its use. Semelab encourages customers to verify that datasheets are current before placing orders.