

MECHANICAL DATA

**GOLD METALLISED  
MULTI-PURPOSE SILICON  
DMOS RF FET  
150W – 28V – 175MHz  
PUSH-PULL**

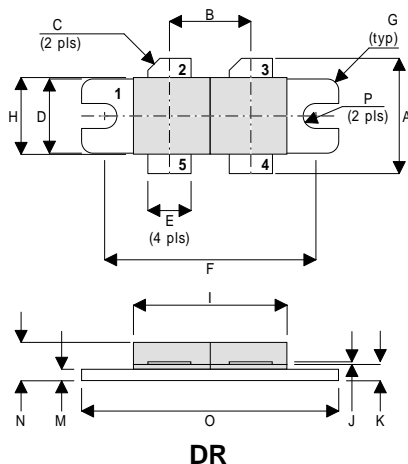

FEATURES

- SIMPLIFIED AMPLIFIER DESIGN
- SUITABLE FOR BROAD BAND APPLICATIONS
- LOW  $C_{rss}$
- SIMPLE BIAS CIRCUITS
- LOW NOISE
- HIGH GAIN – 13 dB MINIMUM

APPLICATIONS

- VHF/UHF COMMUNICATIONS  
from 1 MHz to 200 MHz

PIN 1 SOURCE (COMMON) PIN 2 DRAIN 1  
PIN 3 DRAIN 2 PIN 4 GATE 2  
PIN 5 GATE 1

DIM	Millimetres	Tol.	Inches	Tol.
A	19.05	0.50	0.75	0.020
B	10.77	0.13	0.424	0.005
C	45°	5°	45°	5°
D	9.78	0.13	0.385	0.005
E	5.71	0.13	0.225	0.005
F	27.94	0.13	1.100	0.005
G	1.52R	0.13	0.060R	0.005
H	10.16	0.13	0.400	0.005
I	22.22	MAX	0.875	MAX
J	0.13	0.02	0.005	0.001
K	2.72	0.13	0.107	0.005
M	1.70	0.13	0.067	0.005
N	5.08	0.50	0.200	0.020
O	34.03	0.13	1.340	0.005
P	1.61R	0.08	0.064R	0.003

ABSOLUTE MAXIMUM RATINGS ( $T_{case} = 25^{\circ}C$  unless otherwise stated)

$P_D$	Power Dissipation	438W
$BV_{DSS}$	Drain – Source Breakdown Voltage *	70V
$BV_{GSS}$	Gate – Source Breakdown Voltage*	±20V
$I_{D(sat)}$	Drain Current*	30A
$T_{stg}$	Storage Temperature	–65 to 150°C
$T_j$	Maximum Operating Junction Temperature	200°C

\* Per Side

Semelab Plc reserves the right to change test conditions, parameter limits and package dimensions without notice. Information furnished by Semelab is believed to be both accurate and reliable at the time of going to press. However Semelab assumes no responsibility for any errors or omissions discovered in its use. Semelab encourages customers to verify that datasheets are current before placing orders.

## ELECTRICAL CHARACTERISTICS (T<sub>case</sub> = 25°C unless otherwise stated)

Parameter	Test Conditions	Min.	Typ.	Max.	Unit
<b>PER SIDE</b>					
B <sub>V</sub> DSS	Drain–Source Breakdown Voltage	V <sub>GS</sub> = 0	I <sub>D</sub> = 100mA	70	V
I <sub>DSS</sub>	Zero Gate Voltage Drain Current	V <sub>DS</sub> = 28V	V <sub>GS</sub> = 0		6 mA
I <sub>GSS</sub>	Gate Leakage Current	V <sub>GS</sub> = 20V	V <sub>DS</sub> = 0		1 μA
V <sub>GS(th)</sub>	Gate Threshold Voltage*	I <sub>D</sub> = 10mA	V <sub>DS</sub> = V <sub>GS</sub>	1	7 V
g <sub>fs</sub>	Forward Transconductance*	V <sub>DS</sub> = 10V	I <sub>D</sub> = 6A	4.8	mhos
V <sub>GS(th)match</sub>	Gate Threshold Voltage Matching Between Sides	I <sub>D</sub> = 10mA	V <sub>DS</sub> = V <sub>GS</sub>		0.1 V
<b>TOTAL DEVICE</b>					
G <sub>PS</sub>	Common Source Power Gain	P <sub>O</sub> = 150W		13	dB
η	Drain Efficiency	V <sub>DS</sub> = 28V	I <sub>DQ</sub> = 2A	50	%
VSWR	Load Mismatch Tolerance	f = 175MHz		20:1	—
<b>PER SIDE</b>					
C <sub>iss</sub>	Input Capacitance	V <sub>DS</sub> = 28V	V <sub>GS</sub> = -5V f = 1MHz		360 pF
C <sub>oss</sub>	Output Capacitance	V <sub>DS</sub> = 28V	V <sub>GS</sub> = 0 f = 1MHz		180 pF
C <sub>rss</sub>	Reverse Transfer Capacitance	V <sub>DS</sub> = 28V	V <sub>GS</sub> = 0 f = 1MHz		15 pF

\* Pulse Test: Pulse Duration = 300 μs , Duty Cycle ≤ 2%

## HAZARDOUS MATERIAL WARNING

The ceramic portion of the device between leads and metal flange is beryllium oxide. Beryllium oxide dust is highly toxic and care must be taken during handling and mounting to avoid damage to this area.

**THESE DEVICES MUST NEVER BE THROWN AWAY WITH GENERAL INDUSTRIAL OR DOMESTIC WASTE.**

## THERMAL DATA

R <sub>THj-case</sub>	Thermal Resistance Junction – Case	Max. 0.4°C / W
-----------------------	------------------------------------	----------------

Semelab Plc reserves the right to change test conditions, parameter limits and package dimensions without notice. Information furnished by Semelab is believed to be both accurate and reliable at the time of going to press. However Semelab assumes no responsibility for any errors or omissions discovered in its use. Semelab encourages customers to verify that datasheets are current before placing orders.

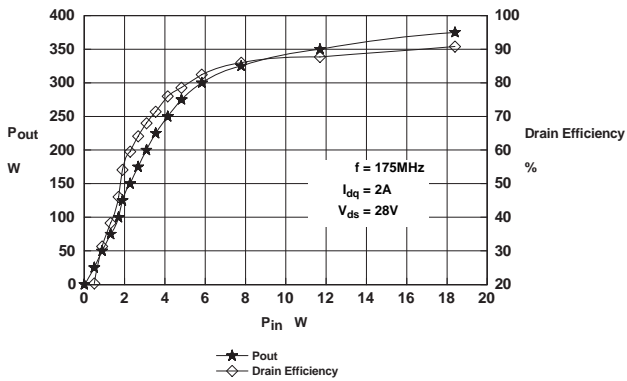

Figure 1 – Power Output and Efficiency vs. Power Input.

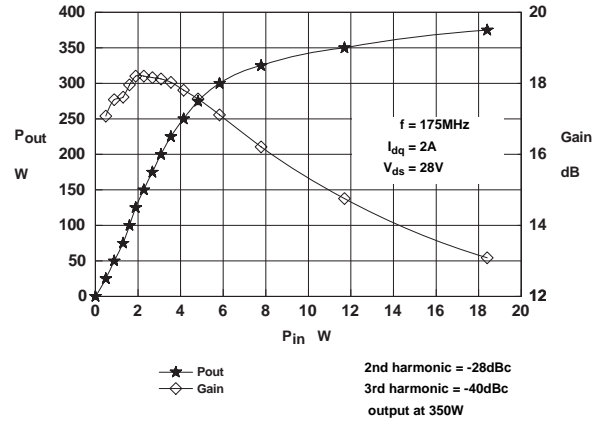

Figure 2 – Power Output & Gain vs. Power Input.

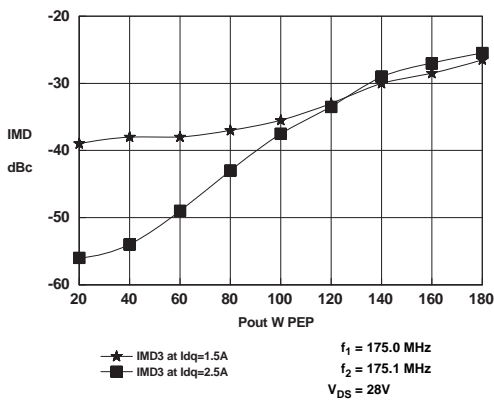

Figure 3 – IMD vs. Output Power.

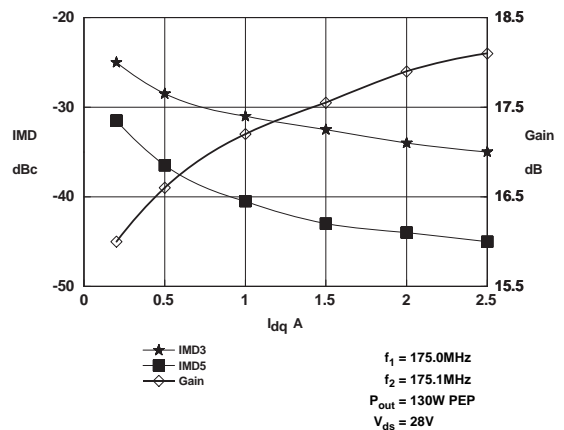

Figure 4 – IMD & Gain vs. Idq

Semelab Plc reserves the right to change test conditions, parameter limits and package dimensions without notice. Information furnished by Semelab is believed to be both accurate and reliable at the time of going to press. However Semelab assumes no responsibility for any errors or omissions discovered in its use. Semelab encourages customers to verify that datasheets are current before placing orders.

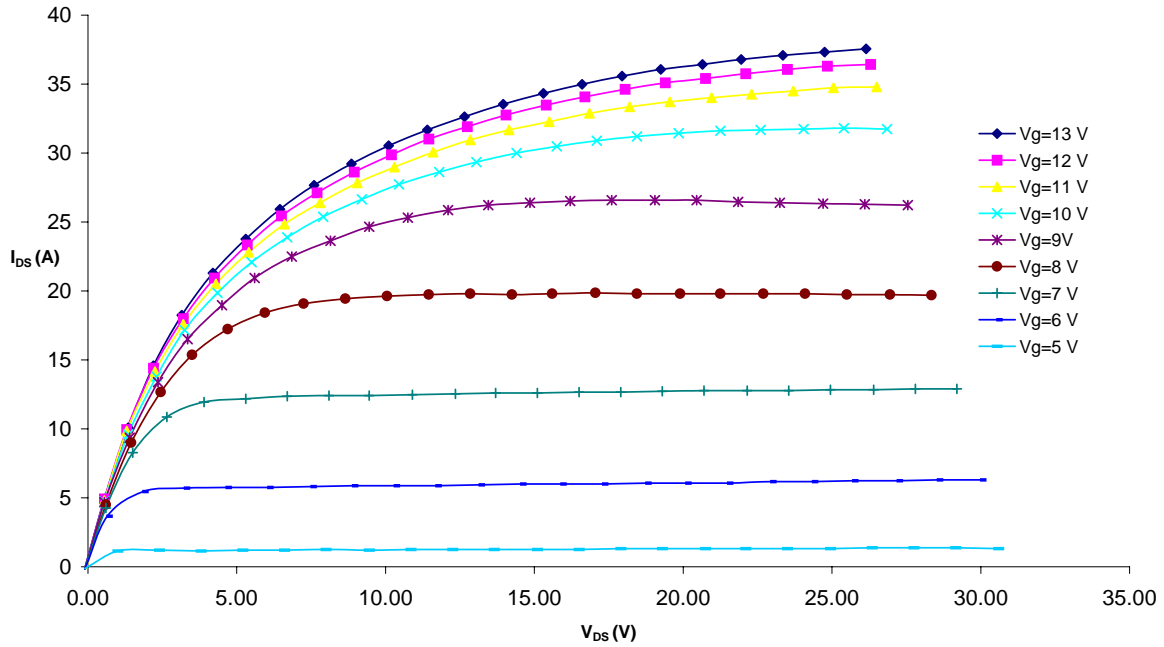

Figure 5 – Typical IV Characteristics.

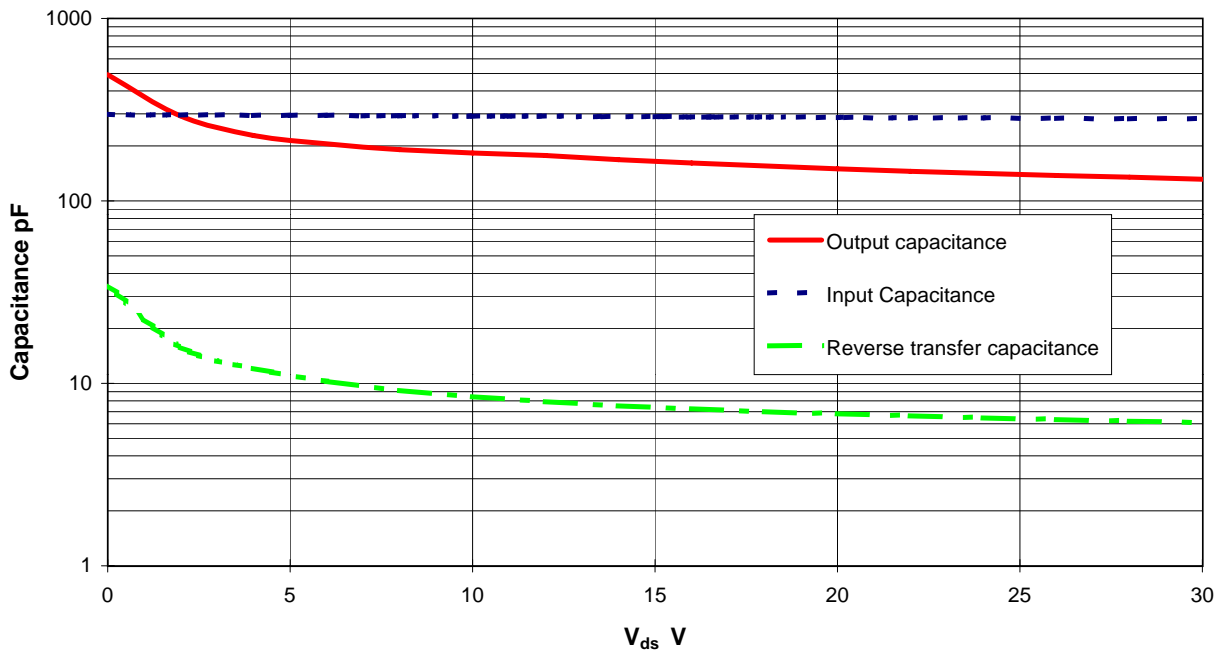

Figure 6 – Typical CV Characteristics.

Semelab Plc reserves the right to change test conditions, parameter limits and package dimensions without notice. Information furnished by Semelab is believed to be both accurate and reliable at the time of going to press. However Semelab assumes no responsibility for any errors or omissions discovered in its use. Semelab encourages customers to verify that datasheets are current before placing orders.

## Typical S Parameters

!  $V_{DS} = 28V$ ,  $I_{DQ} = 1A$  per side

# MHz S M A R 50

fFreq fMHz	S11		S21		S12		S22	
	mag	ang	mag	ang	mag	ang	mag	ang
20	0.828	-161.3	19.78	103.2	0.013	16.4	0.644	-156.3
30	0.836	-165.9	13.83	91.0	0.013	5.8	0.662	-160.3
40	0.846	-168.2	10.27	82.9	0.012	-0.3	0.687	-161.2
50	0.854	-169.2	8.126	75.9	0.012	-5.2	0.708	-162.2
60	0.867	-170.2	6.259	68.5	0.011	-9.0	0.729	-162.6
70	0.873	-171.2	5.331	64.3	0.01	-11.1	0.754	-163.3
80	0.886	-171.4	4.554	59.5	0.009	-12.8	0.78	-163.5
90	0.896	-172.4	3.883	54.9	0.009	-13.9	0.802	-163.9
100	0.904	-173.0	3.362	50.6	0.008	-14.3	0.813	-164.8
110	0.91	-173.2	3.013	48.6	0.007	-13	0.832	-165.4
120	0.92	-173.6	2.558	44.3	0.006	-10.7	0.851	-166.4
130	0.927	-174.1	2.259	41.2	0.006	-7.6	0.861	-166.6
140	0.931	-174.5	2.012	38.1	0.005	-3.4	0.871	-167.3
150	0.934	-175.3	1.85	35.9	0.005	1.7	0.884	-168.0
160	0.941	-175.2	1.652	32.9	0.004	8.6	0.892	-168.8
170	0.942	-175.9	1.475	30.5	0.004	17.5	0.901	-169.5
180	0.951	-175.8	1.306	28.6	0.004	27.6	0.909	-169.5
190	0.95	-176.4	1.215	28.2	0.004	36.0	0.913	-170.2
200	0.958	-177.2	1.094	27.4	0.004	46.6	0.923	-170.7
210	0.958	-177.2	1.014	25.5	0.005	56.5	0.926	-171.3
220	0.96	-178.2	0.938	24.4	0.005	60.9	0.934	-172.1
230	0.963	-178.0	0.897	22.7	0.005	64.8	0.936	-172.0
240	0.965	-178.7	0.806	20.3	0.006	67.6	0.939	-172.7
250	0.968	-178.7	0.738	18.1	0.006	68.9	0.945	-173.1
260	0.967	-179.0	0.692	17.4	0.007	71.7	0.948	-173.8
270	0.969	-179.8	0.662	17.0	0.007	74.8	0.952	-173.8
280	0.97	-179.4	0.618	16.5	0.007	78.9	0.955	-174.1
290	0.971	-179.3	0.581	16.7	0.008	88.3	0.959	-174.3
300	0.972	179.8	0.557	16.0	0.011	87.4	0.958	-174.7
310	0.974	179.8	0.539	14.2	0.011	83.3	0.963	-174.8
320	0.974	179.3	0.505	11.8	0.012	80.1	0.963	-175.3
330	0.978	179.1	0.472	9.7	0.012	78.9	0.967	-176.3
340	0.979	178.8	0.445	7.5	0.012	78.6	0.967	-176.5
350	0.979	178.8	0.419	6.1	0.013	78.4	0.971	-176.6
360	0.978	178.2	0.379	5.3	0.013	78.7	0.968	-177.0
370	0.978	178.5	0.353	4.9	0.013	79.6	0.973	-177.4
380	0.98	177.9	0.343	4.6	0.014	78.9	0.976	-177.2
390	0.983	178.1	0.321	4.4	0.014	77.9	0.972	-178.0
400	0.984	177.6	0.3	7.7	0.014	82.1	0.975	-177.8
410	0.985	177.2	0.304	7.9	0.015	83.8	0.977	-178.1
420	0.981	177.1	0.299	4.7	0.015	82.5	0.978	-178.3
430	0.977	176.8	0.284	2.2	0.015	82.1	0.977	-178.7
440	0.981	176.4	0.264	0.3	0.016	84.2	0.982	-178.9
450	0.981	176.2	0.245	-0.9	0.016	86.8	0.98	-179.6
460	0.985	176.2	0.237	-0.8	0.017	93.2	0.98	-179.5
470	0.985	176.1	0.226	-0.9	0.02	91.8	0.984	-179.5
480	0.986	175.2	0.209	-0.7	0.022	85.2	0.98	-179.9
490	0.982	175.4	0.205	0.2	0.022	82.4	0.984	179.9
500	0.982	175.4	0.194	-1.3	0.021	80.8	0.983	-180.0

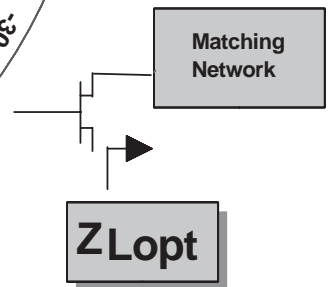
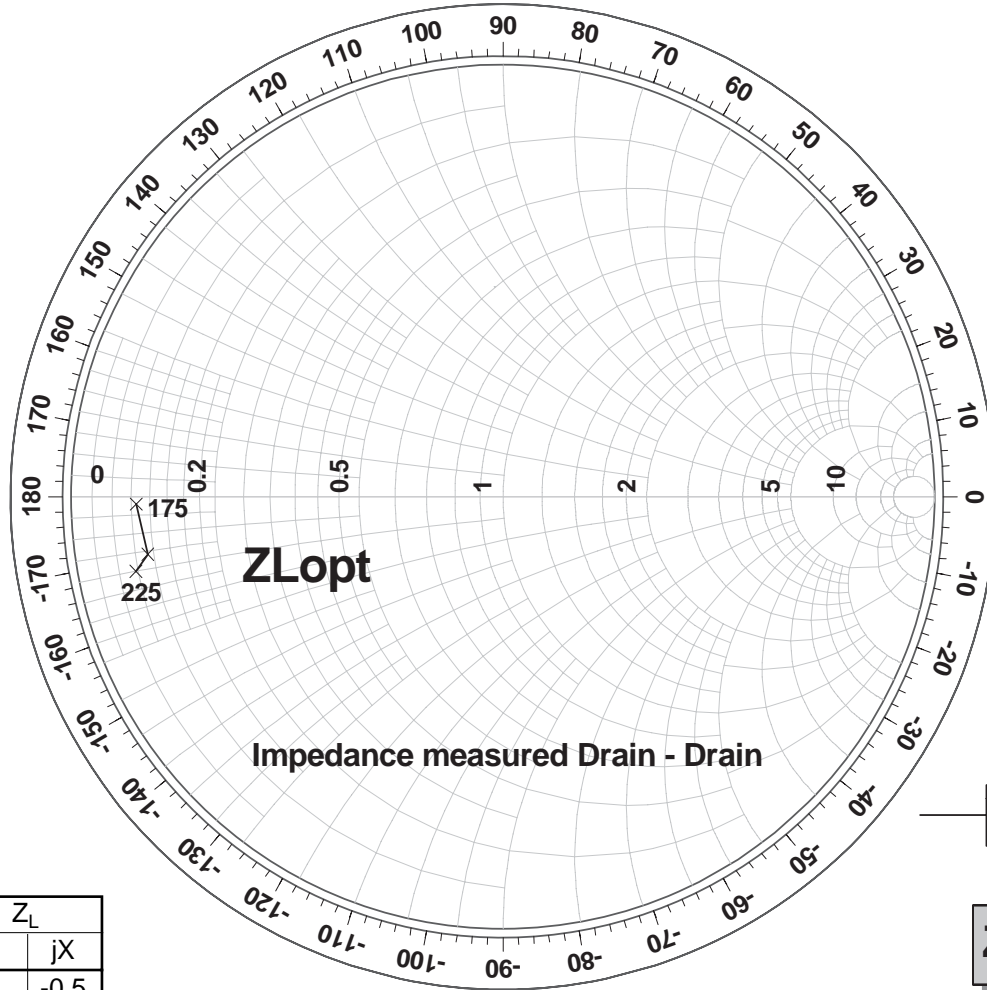

f	Z <sub>L</sub>	
	R	jX
175	4	-0.5
200	4.5	-4
225	3.5	-5

Semelab Plc reserves the right to change test conditions, parameter limits and package dimensions without notice. Information furnished by Semelab is believed to be both accurate and reliable at the time of going to press. However Semelab assumes no responsibility for any errors or omissions discovered in its use. Semelab encourages customers to verify that datasheets are current before placing orders.

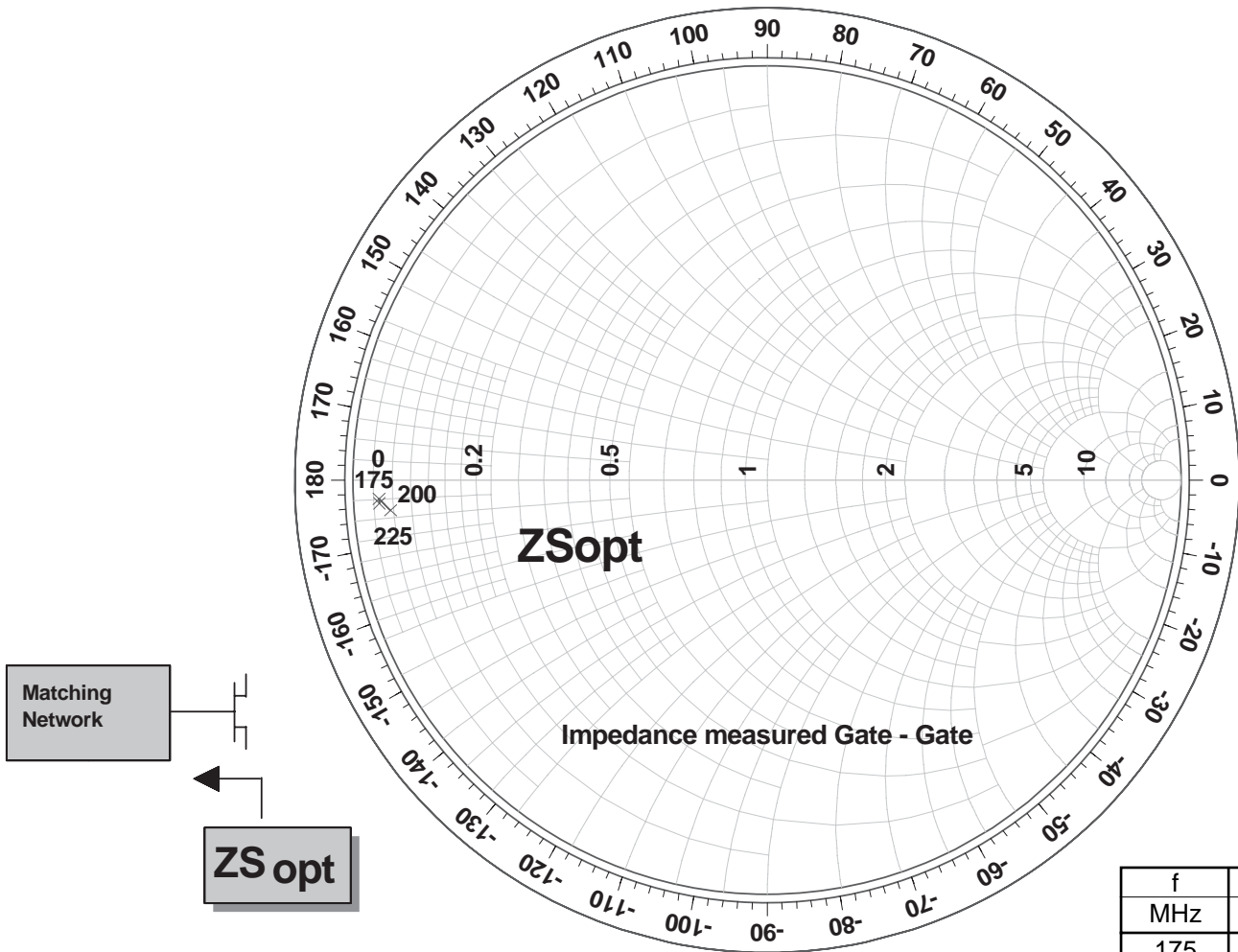

Semelab Plc reserves the right to change test conditions, parameter limits and package dimensions without notice. Information furnished by Semelab is believed to be both accurate and reliable at the time of going to press. However Semelab assumes no responsibility for any errors or omissions discovered in its use. Semelab encourages customers to verify that datasheets are current before placing orders.

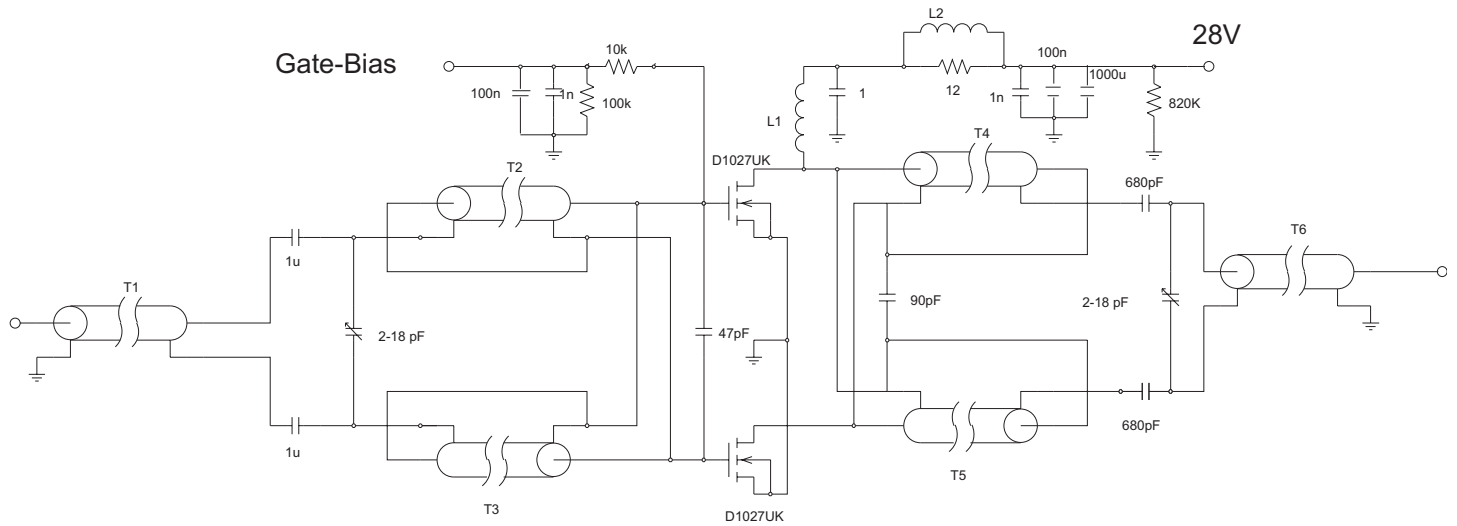

## D1027UK 175MHz TEST FIXTURE

- T1,2,3 7cm Storm Products EXE18 19/30 S1TW coaxial cable on Siemens B62152A1X1 2-hole core.
- T4,5 14cm Storm Products EXE18 19/30 S1TW coaxial cable.
- T6 11cm Storm Products EXE18 19/30 S1TW coaxial cable
- L1 6 turns 1.2mm dia wire, 5mm internal diameter
- L2 1.5 turns 0.9mm dia wire on Siemens A1 x 1 2 hole core

Semelab Plc reserves the right to change test conditions, parameter limits and package dimensions without notice. Information furnished by Semelab is believed to be both accurate and reliable at the time of going to press. However Semelab assumes no responsibility for any errors or omissions discovered in its use. Semelab encourages customers to verify that datasheets are current before placing orders.