

DELPHI SERIES

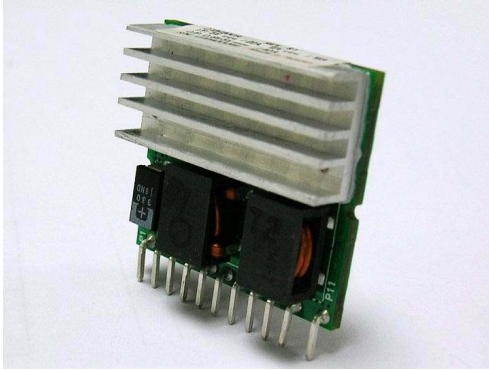

FEATURES

- ◆ High Efficiency: 94% @ 12Vin, 5.0V/40A out
- ◆ Wide input range: 4.5V~13.8V
- ◆ Output voltage programmable from 0.6Vdc to 5.0Vdc via external resistors
- ◆ No minimum load required
- ◆ Fixed frequency operation
- ◆ Input UVLO, output SCP, OVP.
- ◆ Remote On/Off (Positive logic)
- ◆ Power Good Function
- ◆ RoHS 5 / RoHS 6
- ◆ ISO 9001, TL 9000, ISO 14001, QS9000, OHSAS18001 certified manufacturing facility

Delphi D12F200 Non-Isolated Point of Load DC/DC Modules: 4.5V~13.8Vin, 0.6V~5.0Vout, 40A

The D12F200, 4.5~13.8V wide input, single output, non-isolated point of load DC/DC converter is the latest offering from a world leader in power systems technology and manufacturing -- Delta Electronics, Inc. The D12F200 and ND/NE product families are part of the second generation, non-isolated point-of-load DC/DC power modules which cut the module size by almost 50% in most of the cases compared to the first generation NC series POL modules for networking and data communication applications. D12F200 product provides up to 40A output current and the output can be resistor trimmed from 0.6Vdc to 5.0Vdc. It provides a highly efficient, high power and current density and very cost effective point of load solution. With creative design technology and optimization of component placement, these converters possess outstanding electrical and thermal performance, as well as extremely high reliability under highly stressful operating conditions.

APPLICATIONS

- ◆ Telecom / DataCom
- ◆ Distributed power architectures
- ◆ Servers and workstations
- ◆ LAN / WAN applications
- ◆ Data processing applications

DATASHEET
DS_D12F200_01212011

TECHNICAL SPECIFICATIONS

(Ambient Temperature=25°C, nominal V_{in} =12Vdc unless otherwise specified.)

PARAMETER	NOTES and CONDITIONS	D12F200			
		Min.	Typ.	Max.	Units
ABSOLUTE MAXIMUM RATINGS					
Input Voltage		-0.3		13.8	Vdc
Operating Temperature	Refer to Fig.37 for the measuring point	0		70	°C
Storage Temperature		-40		125	°C
INPUT CHARACTERISTICS					
Operating Input Voltage		4.5		13.8	V
Input Under-Voltage Lockout					
Turn-On Voltage Threshold			4.3		Vdc
Turn-Off Voltage Threshold			4.0		Vdc
Maximum Input Current	$V_{in}=12V, V_o=5V, I_o=40A$			18	A
No-Load Input Current	$V_{in}=12V, V_o=5V, I_o=40A$		260	300	mA
Off Converter Input Current	Remote OFF		17	20	mA
Input voltage slew rate	dV/dt			10	V/mS
OUTPUT CHARACTERISTICS					
Output Voltage Adjustment Range	Refer to Fig.19 for the relations between input and output voltage	0.6		5.0	Vdc
Output Voltage Set Point	With a 0.1% trim resistor	-1.0		+1.0	%Vo
Output Voltage Regulation					
Over Load	$V_o = 1.2Vdc$ $V_o > 1.2Vdc$	-20		+20	mV
Over Line	$V_{in}=V_{in_min}$ to V_{in_max}	-0.5		+0.5	%Vo
Total output range	Over load, line, temperature regulation and set point	-3.0		+3.0	%Vo
Output Voltage Ripple and Noise	5Hz to 20MHz bandwidth				
Peak-to-Peak	Full Load, 10uF Tan cap, total input & output range		20	50	mV
Output Current Range		0		40	A
Output Voltage Under-shoot at Power-Off	$V_{in}=12V$, Turn OFF			100	mV
Output short-circuit current, RMS value	$12V_{in}, 5V_{out}$		10		A
Over Current Protection	Hiccup mode		70		A
Over Voltage Protection	Non-latching shutdown		120		%
DYNAMIC CHARACTERISTICS					
Transient Response	25% step load, Slew rate=10A/uS, 0.6V~1.8V output		120	150	mVpk
	25% step load, Slew rate=10A/uS, 2.5V~5.0V output		130	160	mVpk
Output Dynamic Load Response	$12V_{in}, 2.5V_{out}, 1\mu F$ ceramic and $10\mu F$ Tan cap				
Settling Time	Settling to be within regulation band (to 10% Vo deviation)		20	50	μs
Turn-On Transient					
Rise Time	From 10% to 90% of Vo		8	15	mS
Turn on Delay (power)	$V_{in}=12V, I_o=\text{min-max}$. (Within 10% of Vo)		13	25	mS
Turn on Delay (Remote on/off)	$V_{in}=12V, I_o=\text{min-max}$. (Within 10% of Vo)		13	20	mS
Turn on Transient (overshoot)			0.5%		Vo
Turn off Transient (undershoot)				100	mV
Maximum Output Capacitance	ESR = 10mΩ	0		20000	μF
	ESR < 10mΩ	0		5000	μF
EFFICIENCY					
$V_o=0.6V$	$V_{in}=12V, I_o=40A$	70	71.4		%
$V_o=0.9V$	$V_{in}=12V, I_o=40A$	78	79.4		%
$V_o=1.2V$	$V_{in}=12V, I_o=40A$	81	83.5		%
$V_o=1.5V$	$V_{in}=12V, I_o=40A$	84	85.9		%
$V_o=1.8V$	$V_{in}=12V, I_o=40A$	85	87.5		%
$V_o=2.5V$	$V_{in}=12V, I_o=40A$	88	90.4		%
$V_o=3.3V$	$V_{in}=12V, I_o=40A$	90	92.2		%
$V_o=5.0V$	$V_{in}=12V, I_o=40A$	92	94.0		%
FEATURE CHARACTERISTICS					
Switching Frequency	Fixed, per phase		500		KHz
ON/OFF Control	Positive logic (internally pulled high)				
Logic High	Module On (or leave the pin open)	1.2		V_{inmax}	V
Logic Low	Module Off	0		0.6	V
Remote Sense Range				0.5	V
Power Good	Vo is out off +/-10% Vo,set	0		0.4	V
	Vo is within +/-10% Vo,set	4.0		5.1	V
Power Good Delay			0.2	2	mS
Output to Power Good Delay Time				1	mS
GENERAL SPECIFICATIONS					
Calculated MTBF	25 , 300LFM, 80% load		5.6		Mhours
Weight			14		grams



ELECTRICAL CHARACTERISTICS CURVES

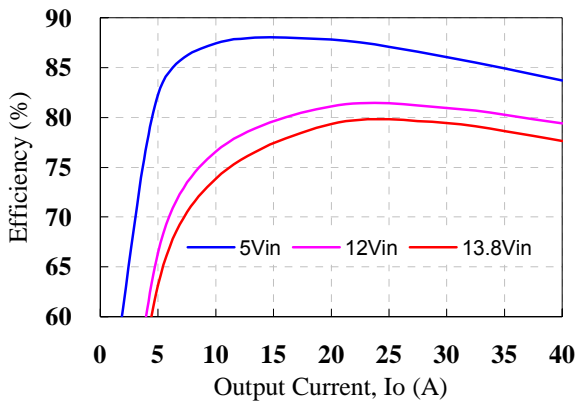

Figure 1: Converter efficiency vs. output current (0.9V output voltage, 5V&12V input)

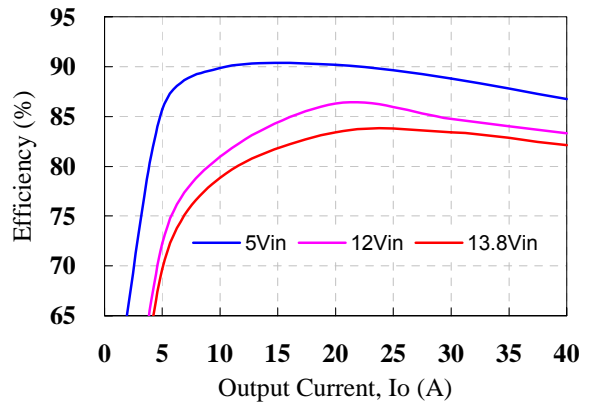

Figure 2: Converter efficiency vs. output current (1.2V output voltage, 5V&12V input)

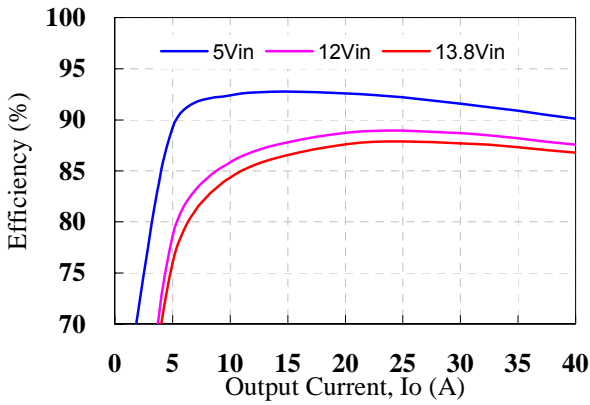

Figure 3: Converter efficiency vs. output current (1.8V output voltage, 5V&12V input)

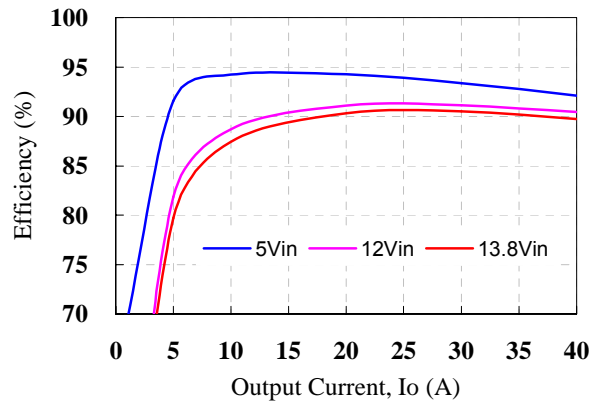

Figure 4: Converter efficiency vs. output current (2.5V output voltage, 5V&12V input)

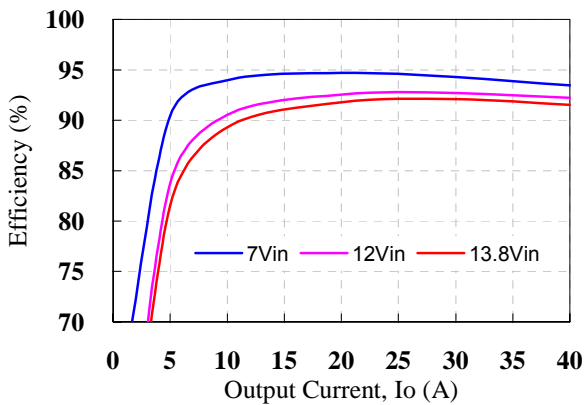

Figure 5: Converter efficiency vs. output current (3.3V output voltage, 12V input)

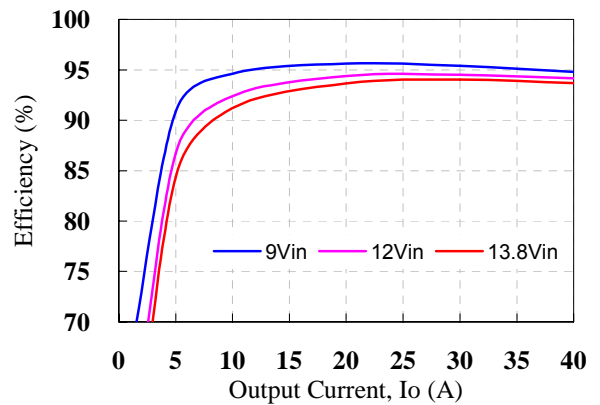

Figure 6: Converter efficiency vs. output current (5.0V output voltage, 12V input)



ELECTRICAL CHARACTERISTICS CURVES (CONTINUED)

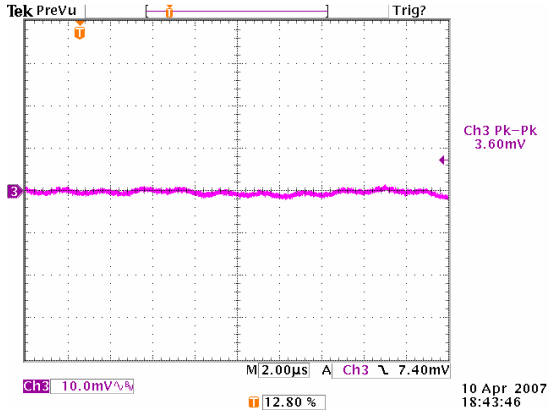

Figure 7: Output ripple & noise at 12Vin, 0.9V/40A out (10mv/div, 2uS/div)

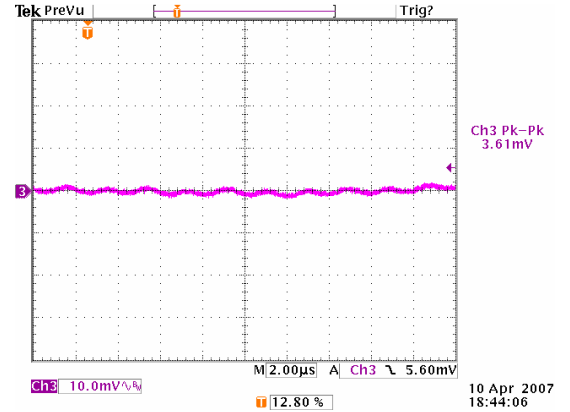

Figure 8: Output ripple & noise at 12Vin, 1.2V/40A out (10mv/div, 2uS/div)

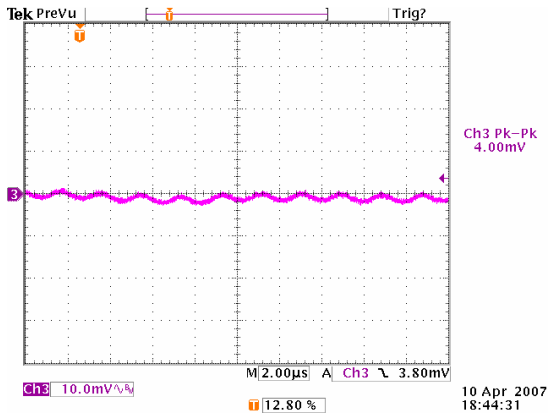

Figure 9: Output ripple & noise at 12Vin, 1.8V/40A out (10mv/div, 2uS/div)

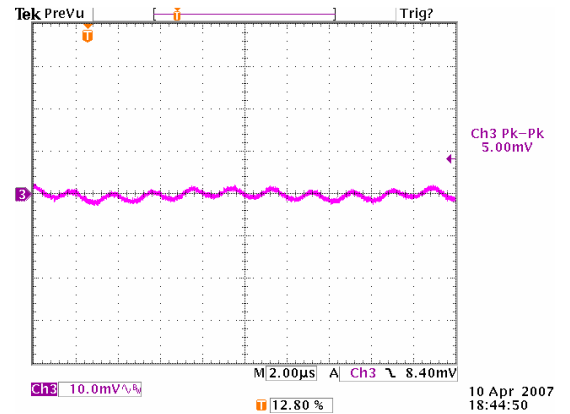

Figure 10: Output ripple & noise at 12Vin, 2.5V/40A out (10mv/div, 2uS/div)

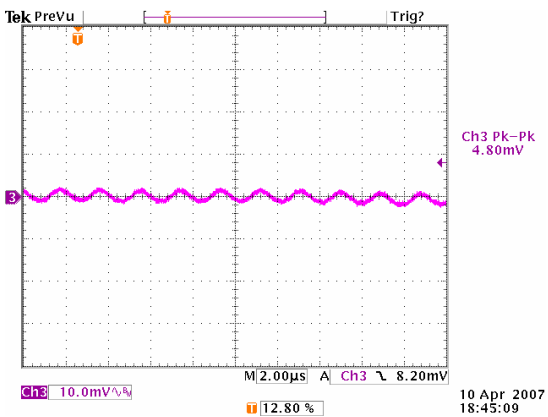

Figure 11: Output ripple & noise at 12Vin, 3.3V/40A out (10mv/div, 2uS/div)

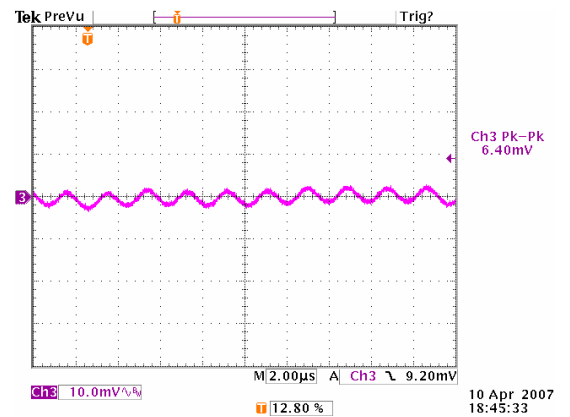

Figure 12: Output ripple & noise at 12Vin, 5.0V/40A out (10mv/div, 2uS/div)



ELECTRICAL CHARACTERISTICS CURVES (CONTINUED)

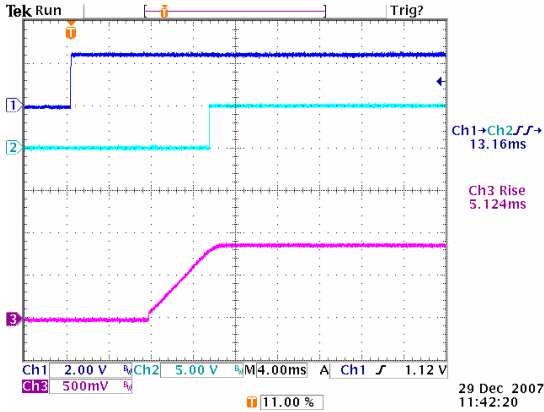

Figure 13: Turn on delay time at 12Vin, 0.9V/40A out (4mS/div)
Ch1: Enable, Ch2: PG, Ch3: Vo

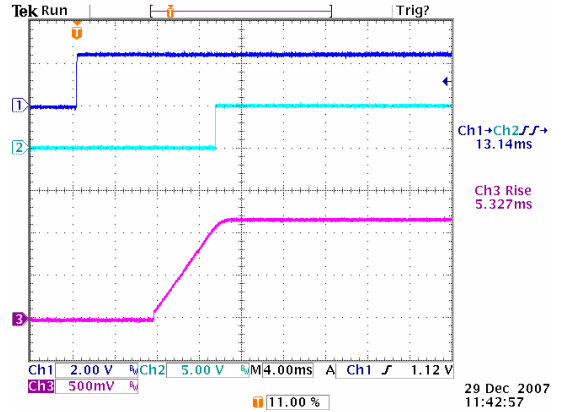

Figure 14: Turn on delay time at 12Vin, 1.2V/40A out (4mS/div)
Ch1: Enable, Ch2: PG, Ch3: Vo

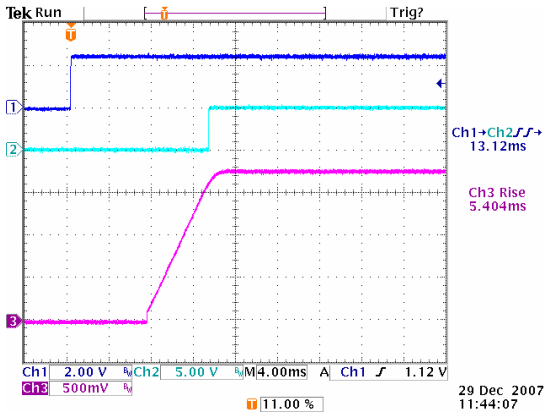

Figure 15: Turn on delay time at 12Vin, 1.8V/40A out (4mS/div)
Ch1: Enable, Ch2: PG, Ch3: Vo

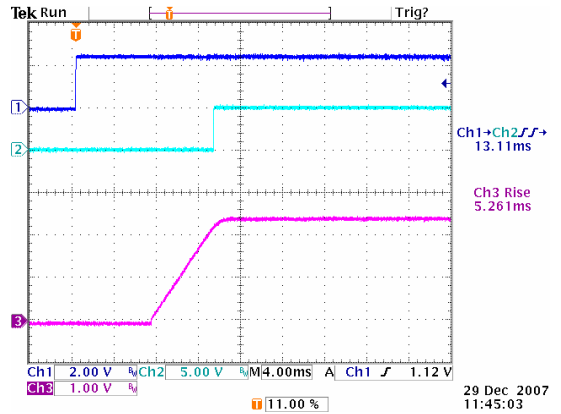

Figure 16: Turn on delay time at 12Vin, 2.5V/40A out (4mS/div)
Ch1: Enable, Ch2: PG, Ch3: Vo

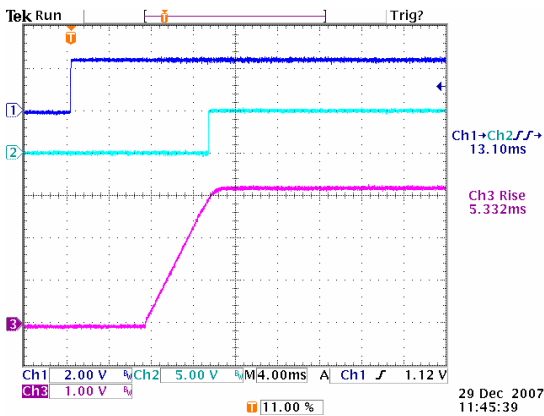

Figure 17: Turn on delay time at 12Vin, 3.3V/40A out (4mS/div)
Ch1: Enable, Ch2: PG, Ch3: Vo

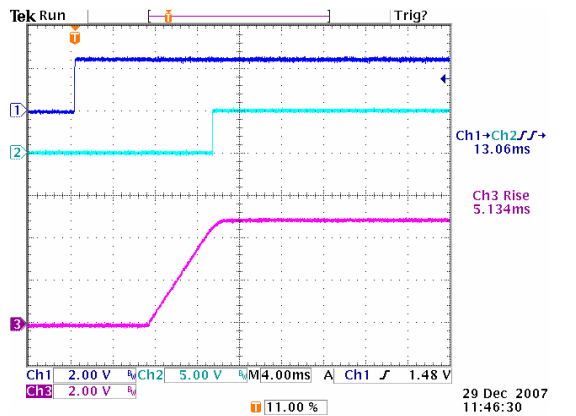

Figure 18: Turn on delay time at 12Vin, 5.0V/40A out (4mS/div)
Ch1: Enable, Ch2: PG, Ch3: Vo



ELECTRICAL CHARACTERISTICS CURVES (CONTINUED)

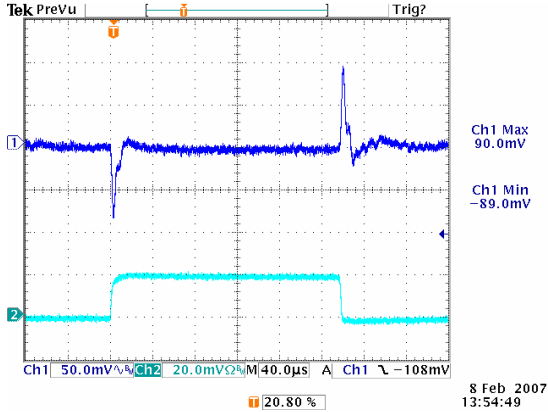

Figure 19: Transient Response at 12Vin, 0.9V/40A out (40uS/div)
Ch1: Vo, Ch2: Io, 10A/div

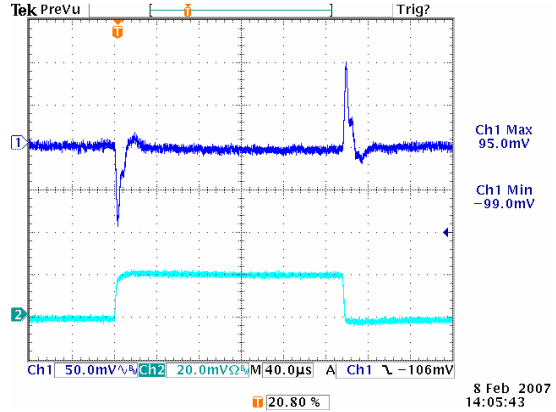

Figure 20: Transient Response at 12Vin, 1.2V/40A out (40uS/div)
Ch1: Vo, Ch2: Io, 10A/div

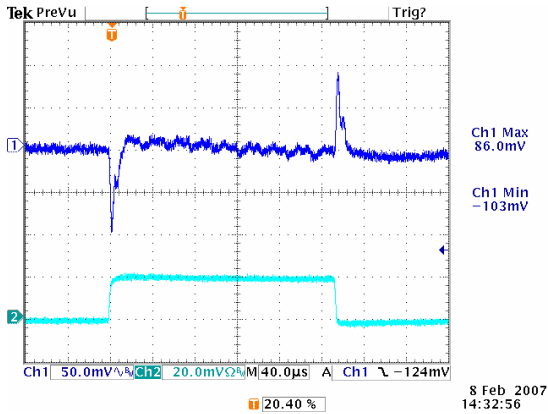

Figure 21: Transient Response at 12Vin, 1.8V/40A out (40uS/div)
Ch1: Vo, Ch2: Io, 10A/div

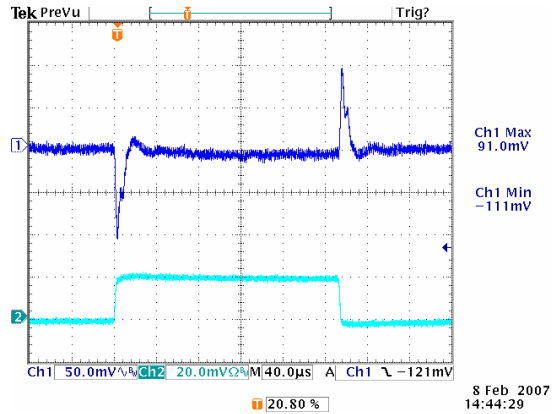

Figure 22: Transient Response at 12Vin, 2.5V/40A out (40uS/div)
Ch1: Vo, Ch2: Io, 10A/div

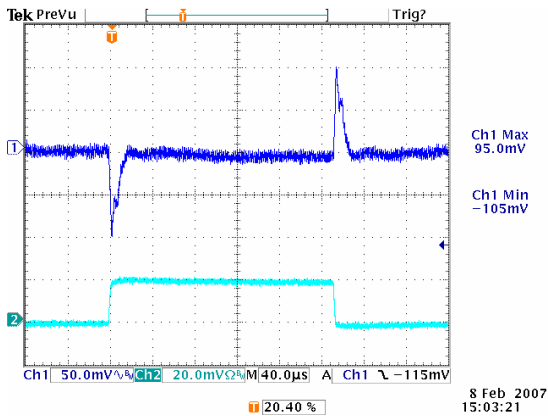

Figure 23: Transient Response at 12Vin, 3.3V/40A out (40uS/div)
Ch1: Vo, Ch2: Io, 10A/div

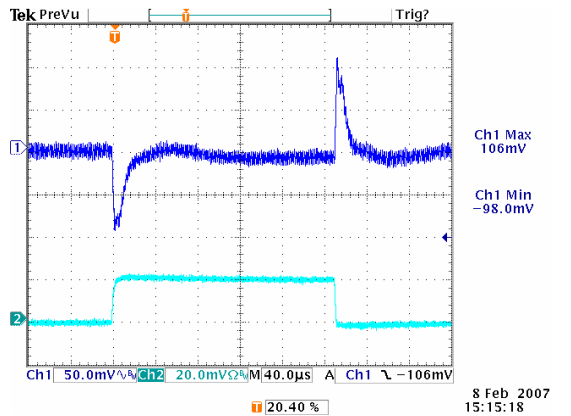

Figure 24: Transient Response at 12Vin, 5.0V/40A out (40uS/div)
Ch1: Vo, Ch2: Io, 10A/div



ELECTRICAL CHARACTERISTICS CURVES (CONTINUED)

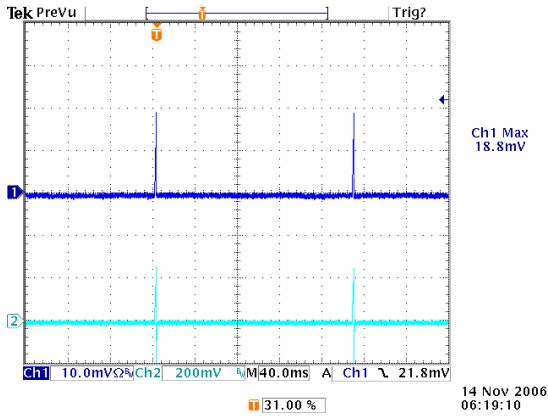

Figure 25: Short Circuit Protection at 12Vin, 0.9V out (40mS/div), Ch1: Vo, Ch2: Io, 50A/div

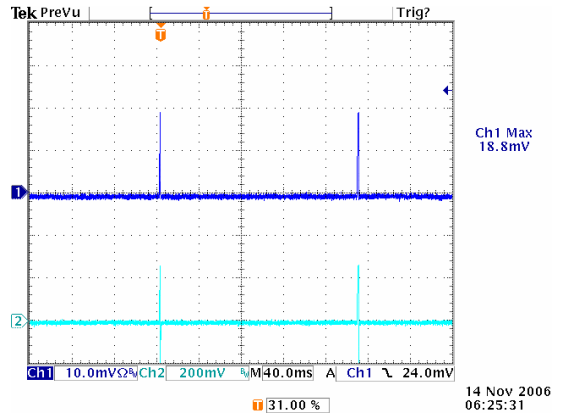

Figure 26: Short Circuit Protection at 12Vin, 1.2V out (40mS/div), Ch1: Vo, Ch2: Io, 50A/div

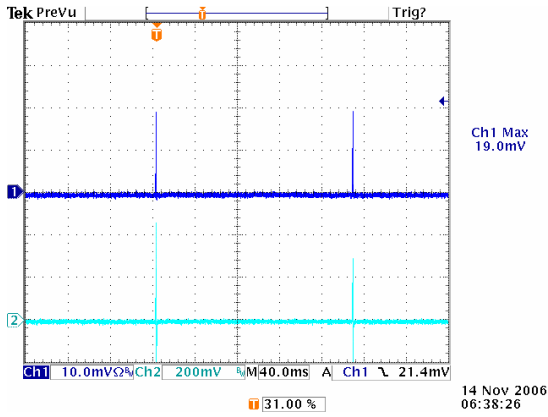

Figure 27: Short Circuit Protection at 12Vin, 1.8V out (40mS/div), Ch1: Vo, Ch2: Io, 50A/div

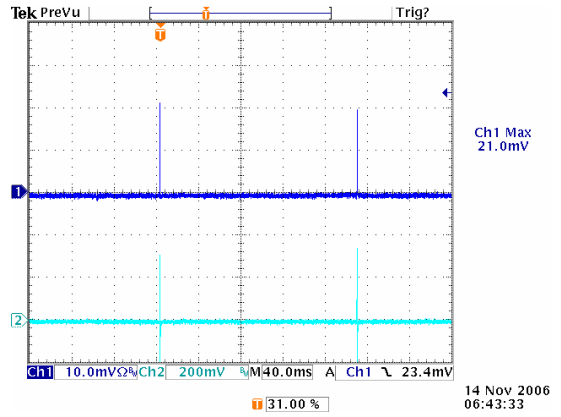

Figure 28: Short Circuit Protection at 12Vin, 2.5V out (40mS/div), Ch1: Vo, Ch2: Io, 50A/div

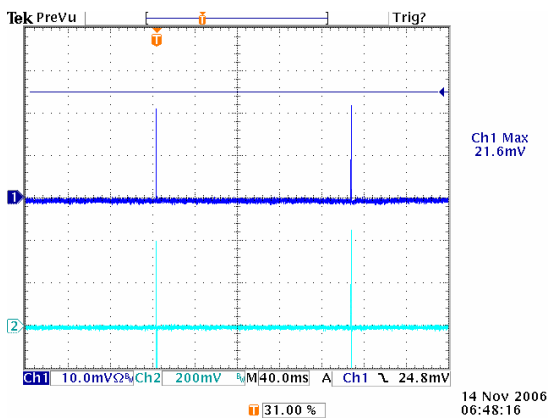

Figure 29: Short Circuit Protection at 12Vin, 3.3V out (40mS/div), Ch1: Vo, Ch2: Io, 50A/div

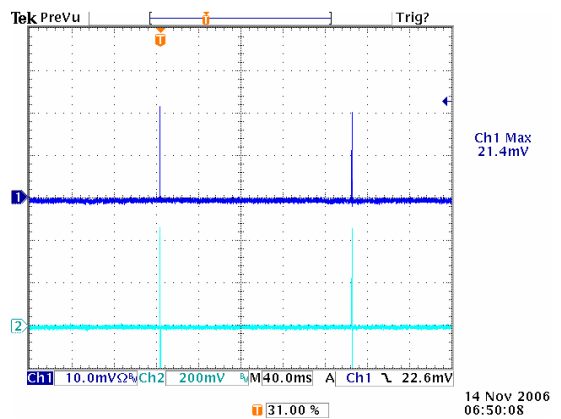

Figure 30: Short Circuit Protection at 12Vin, 5.0V out (40mS/div), Ch1: Vo, Ch2: Io, 50A/div

DESIGN CONSIDERATIONS

The D12F200 uses a two phase and voltage mode controlled buck topology. The output can be trimmed in the range of 0.6Vdc to 5.0Vdc by a resistor from Trim pin to Ground.

The converter can be turned ON/OFF by remote control. Positive on/off (ENABLE pin) logic implies that the converter DC output is enabled when the signal is driven high (greater than 1.2V) or floating and disabled when the signal is driven low (below 0.6V).

The converter provides an open collector Power Good signal. The power good signal is pulled low when output is not within $\pm 10\%$ of Vout or Enable is OFF.

For output voltages above 1.8V, please refer to Figure 31 below for minimum input voltage requirement for proper module operations.

The converter can protect itself by entering hiccup mode against over current and short circuit condition.

Safety Considerations

It is recommended that the user to provide a fuse in the input line for safety. The output voltage set-point and the output current in the application could define the amperage rating of the fuse.

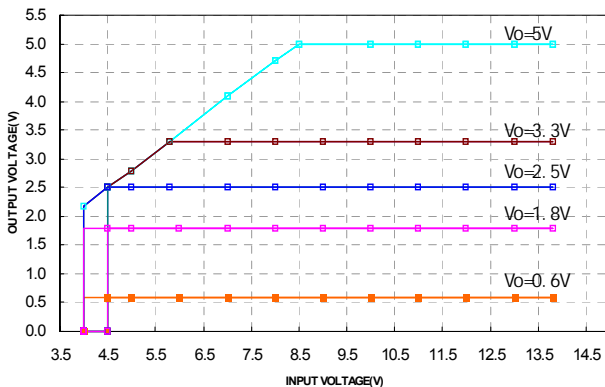

Figure 31: minimum input voltage required for output voltages above 1.8V

DS_D12F200_01212011

FEATURES DESCRIPTIONS

Enable (On/Off)

The ENABLE (on/off) input allows external circuitry to put the D12F200 converter into a low power dissipation (sleep) mode. Positive ENABLE is available as standard.

Positive ENABLE units of the D12F200 series are turned on if the ENABLE pin is high or floating. Pulling the pin low will turn off the unit. With the active high function, the output is guaranteed to turn on if the ENABLE pin is driven above 1.2V. The output will turn off if the ENABLE pin voltage is pulled below 0.6V.

Input Under-Voltage Lockout

The input under-voltage lockout prevents the converter from being damaged while operating when the input voltage is too low. The under-voltage lockout is adjustable by adding a resistor (Figure 32) between Enable pin and ground pin per the following equation:

$$R_{en}(K\Omega) = \frac{315}{14V_{en} + 3.8}$$

Default lockout range is between 4.3V and 4.0V.

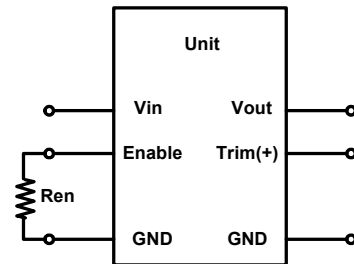
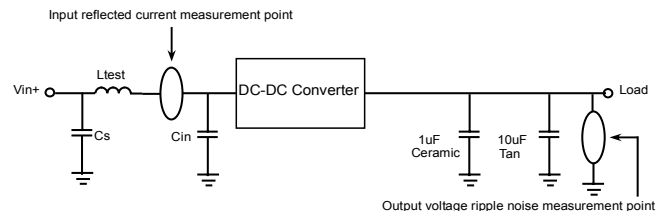

Figure 32: Enable input drive circuit example.

Reflected Ripple Current and Output Ripple and Noise Measurement

The measurement set-up outlined in Figure 33 has been used for both input reflected/ terminal ripple current and output voltage ripple and noise measurements on D12F200 converters.



Cs=330 μ F OS-con cap x1, Ltest=1 μ H, Cin=330 μ F OS-con cap x1

Figure 33: Input reflected ripple/ capacitor ripple current and output voltage ripple and noise measurement setup for D12F200

FEATURES DESCRIPTIONS (CON.)

Over-Current and Short-Circuit Protection

The D12F200 modules have non-latching over-current and short-circuit protection circuitry. When over current condition occurs, the module goes into the non-latching hiccup mode. When the over-current condition is removed, the module will resume normal operation.

An over current condition is detected by measuring the voltage drop across the inductor. The voltage drop across the inductor is also a function of the inductor's DCR.

Note that none of the module specifications are guaranteed when the unit is operated in an over-current condition.

Output Over Voltage Protection (OVP)

The converter will shut down when an output over voltage protection is detected. Once the OVP condition is detected, controller will stop all PWM outputs and turn on low-side MOSFET to prevent any damage to load.

Remote Sense

The D12F200 provide V_o remote sensing to achieve proper regulation at the load points and reduce effects of distribution losses on output line. In the event of an open remote sense line, the module shall maintain local sense regulation through an internal resistor. The module shall correct for a total of 0.5V of loss. The remote sense connects as shown in Figure 34.

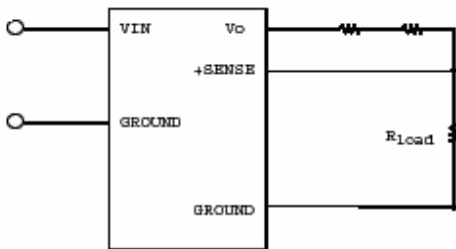

Figure 34: Circuit configuration for remote sense

Output Capacitance

There are internal output capacitors on the D12F200 modules. Hence, no external output capacitor is required for stable operation.

Output Voltage Programming

The output voltage of the D12F200 is trimmable by connecting an external resistor between the trim pin and output ground as shown Figure 35 and the typical trim resistor values are shown in Table 1.

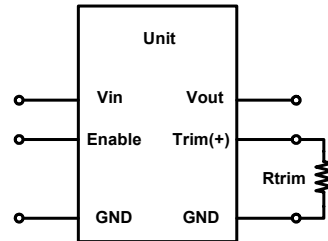

Figure 35: Trimming Output Voltage

The D12F200 module has a trim range of 0.6V to 5.0V. The trim resistor equation for the D12F200 is:

$$R_{trim}(\Omega) = \frac{1200}{V_{out} - 0.6}$$

V_{out} is the output voltage setpoint

R_{trim} is the resistance between Trim and Ground

R_{trim} values should not be less than 270 Ω

Output	$R_{trim} (\Omega)$
0.6V	open
+0.9 V	4K
+1.2V	2K
+1.5 V	1.33K
+1.8V	1K
+2.5 V	631.6
+3.3 V	444.4
+5.0V	272.7

Table 1: Typical trim resistor values

Power Good

The converter provides an open collector signal called Power Good. This output pin uses positive logic and is open collector. This power good output is able to sink 4mA and set high when the output is within $\pm 10\%$ of output set point. The power good signal is pulled low when output is not within $\pm 10\%$ of V_{out} or Enable is OFF.

Paralleling

D12F200 converters do not have built-in current sharing (paralleling) ability. Hence, paralleling of multiple D12F200 converters is not recommended.



THERMAL CONSIDERATION

Thermal management is an important part of the system design. To ensure proper, reliable operation, sufficient cooling of the power module is needed over the entire temperature range of the module. Convection cooling is usually the dominant mode of heat transfer.

Hence, the choice of equipment to characterize the thermal performance of the power module is a wind tunnel.

Thermal Testing Setup

Delta's DC/DC power modules are characterized in heated vertical wind tunnels that simulate the thermal environments encountered in most electronics equipment. This type of equipment commonly uses vertically mounted circuit cards in cabinet racks in which the power modules are mounted.

The following figure shows the wind tunnel characterization setup. The power module is mounted on a test PWB and is vertically positioned within the wind tunnel. The space between the neighboring PWB and the top of the power module is constantly kept at 6.35mm (0.25").

Thermal Derating

Heat can be removed by increasing airflow over the module. To enhance system reliability, the power module should always be operated below the maximum operating temperature. If the temperature exceeds the maximum module temperature, reliability of the unit may be affected.

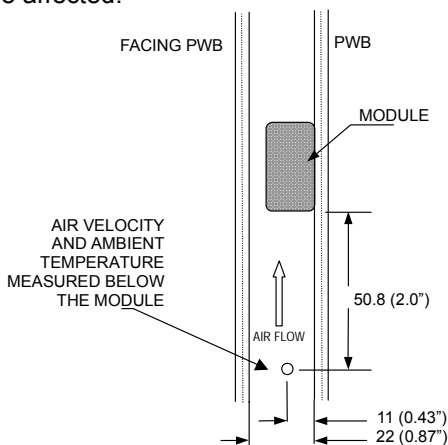

Note: Wind tunnel test setup figure dimensions are in millimeters and (Inches)

Figure 36: Wind tunnel test setup

DS_D12F200_01212011

THERMAL CURVES

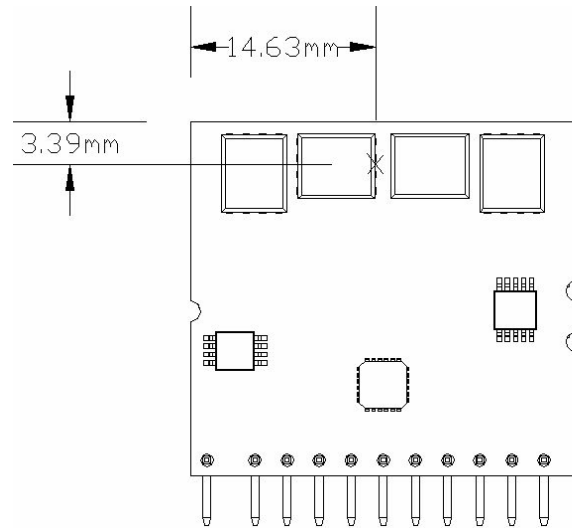

Figure 37: Temperature measurement location* The allowed maximum hot spot temperature is defined at 125

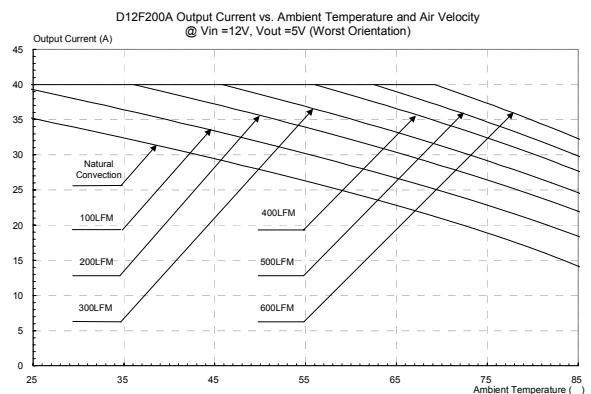

Figure 38: Output current vs. ambient temperature and air velocity @ Vin=12V, Vout=5.0V (Airflow from Pin1 to Pin11)

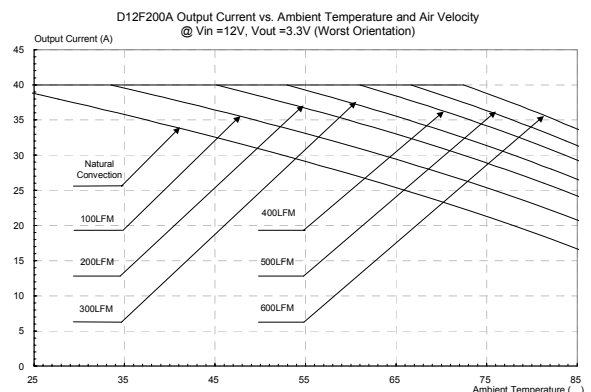

Figure 39: Output current vs. ambient temperature and air velocity @ Vin=12V, Vout=3.3V (Worst Orientation)

THERMAL CURVES

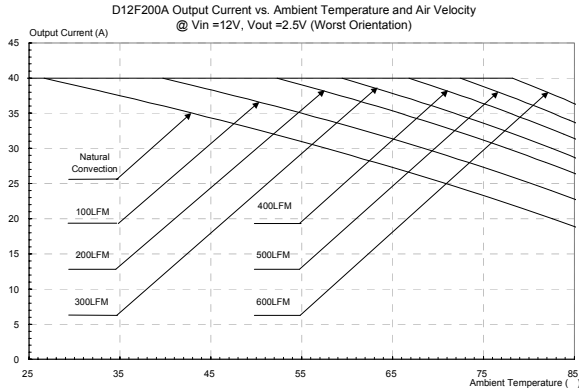

Figure 40: Output current vs. ambient temperature and air velocity @ Vin=5.0V, Vout=2.5V (Worst Orientation)

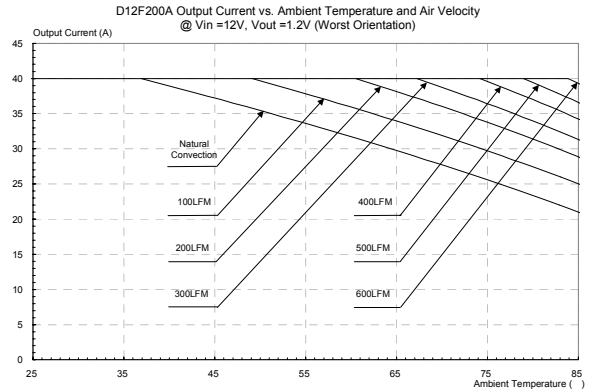

Figure 43: Output current vs. ambient temperature and air velocity @ Vin=12V, Vout=1.2V (Worst Orientation)

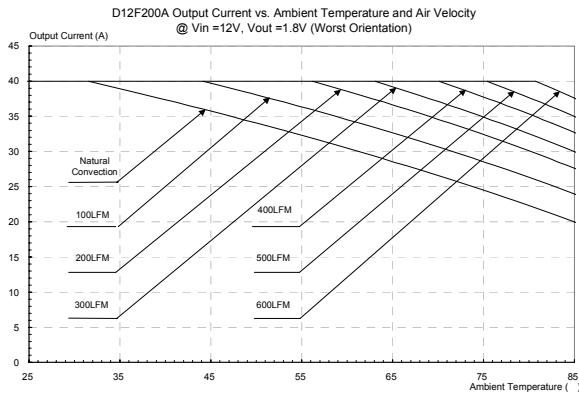

Figure 41: Output current vs. ambient temperature and air velocity @ Vin=12V, Vout=1.8V (Worst Orientation)

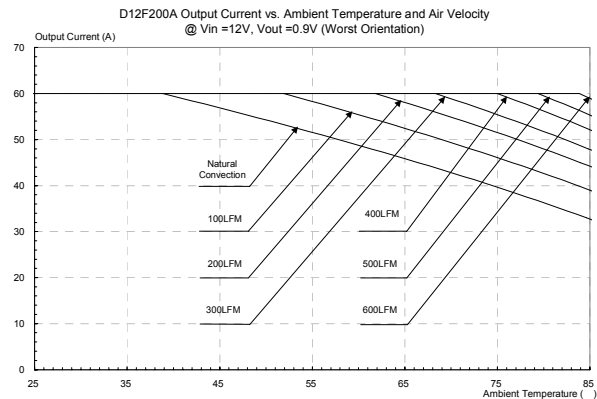

Figure 44: Output current vs. ambient temperature and air velocity @ Vin=12V, Vout=0.9V (Worst Orientation)

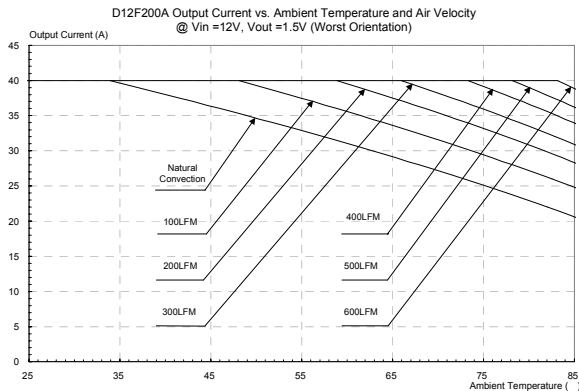
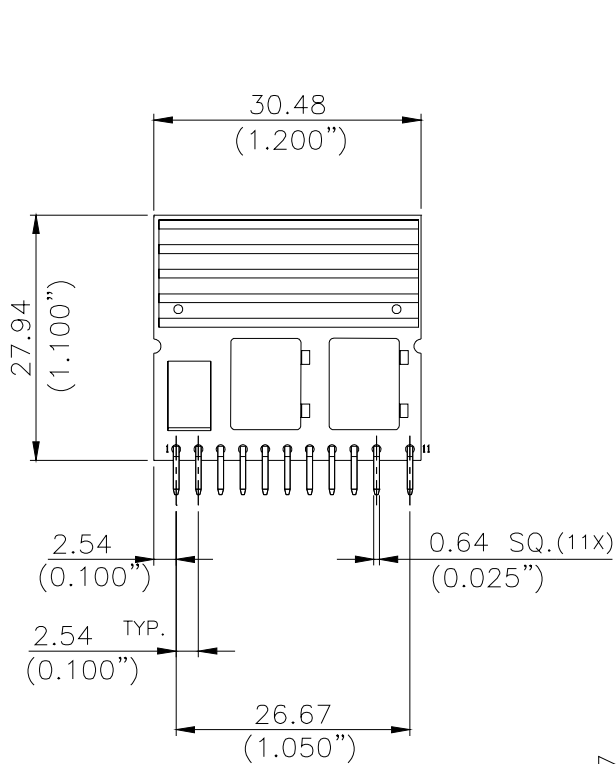

Figure 42: Output current vs. ambient temperature and air velocity @ Vin=5.0V, Vout=1.5V (Worst Orientation)



MECHANICAL DRAWING



PIN#	Function	PIN#	Function
1	Vout	7	GROUND
2	Vout	8	GROUND
3	Vout	9	+SENSE
4	TRIM	10	Vin
5	ENABLE	11	Vin
6	PG		

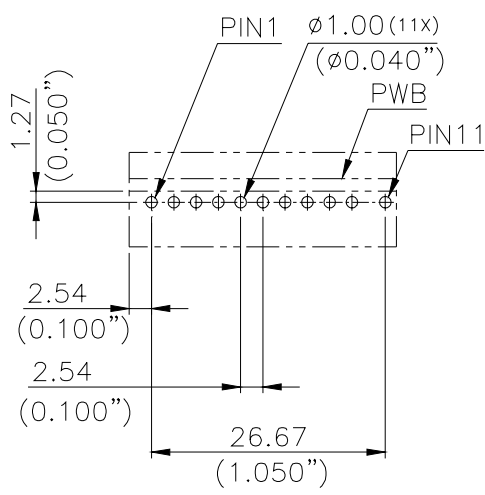
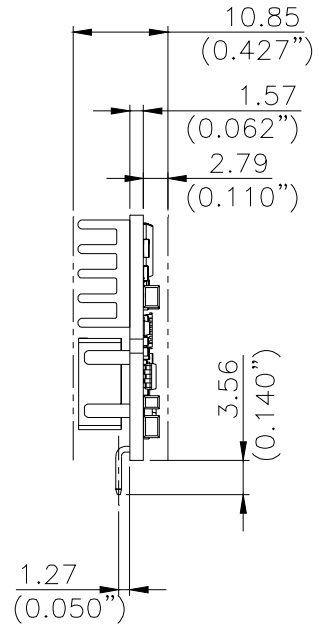

RECOMMENDED P.W.B LAYOUT

NOTES:

1. DIMENSIONS ARE IN MILLIMETERS AND (INCHES).
2. TOLERANCES: X.Xmm±0.5mm (X.XX in. ±0.02 in.)
X.XXmm±0.25mm (X.XXX in. ±0.010 in.)



PART NUMBERING SYSTEM

D	12	F	200	A
Type of Product	Input Voltage	Product Series	Output	Option Code
D - DC/DC modules	12 - 4.5 ~13.8V		200 - 200W/40A	A - standard

MODEL LIST

Model Name	Input Voltage	Output Voltage	Output Current	Lead Free	Efficiency, 12Vin
D12F200A	4.5V~ 13.8Vdc	0.6V ~ 5.0V	40A	RoHs 6	94% @ 5V/40A
D12F200B	4.5V~ 13.8Vdc	0.6V ~ 5.0V	40A	RoHs 5	94% @ 5V/40A

CONTACT: www.delta.com.tw/dcdc

USA:

Telephone:
 East Coast: (888) 335 8201
 West Coast: (888) 335 8208
 Fax: (978) 656 3964
 Email: DCDC@delta-corp.com

Europe:

Telephone: +41 31 998 53 11
 Fax: +41 31 998 53 53
 Email: DCDC@delta-es.tw

Asia & the rest of world:

Telephone: +886 3 4526107 ext. 6220~6224
 Fax: +886 3 4513485
 Email: DCDC@delta.com.tw

WARRANTY

Delta offers a two (2) year limited warranty. Complete warranty information is listed on our web site or is available upon request from Delta.

Information furnished by Delta is believed to be accurate and reliable. However, no responsibility is assumed by Delta for its use, nor for any infringements of patents or other rights of third parties, which may result from its use. No license is granted by implication or otherwise under any patent or patent rights of Delta. Delta reserves the right to revise these specifications at any time, without notice.

DS_D12F200_01212011