

MODEL SERIES D

Single In-Line Conformal Coated Diode Network

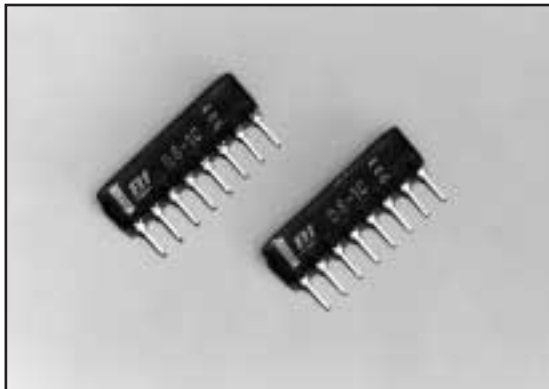

FEATURES

- 4 to 14 pins
- Multiple circuit configurations
- Space saving design

ELECTRICAL

| | |
|------------------------------------|---|
| Reverse Voltage, V_R | 80V |
| Reverse Current, I_R | 1.0 μ A ($V_R=70V$) |
| Forward Current, I_F | 100mA average 300mA Surge (1 μ s Max.) |
| Forward Voltage, V_F | 1.5V @ $I_F=100mA$ |
| Package Power, P_{PKG} | 200mW @ 25°C |
| Reverse Recovery Time, t_{rr} | 4ns ($V_R=6V$, $I_F=5mA$, $R_L=50\Omega$) |
| Capacitance, C | 5.5pF ($V_R=6V$, $f=1MHz$) |
| Junction Temperature, T_J , Max. | 125°C |
| Storage Temperature | -55°C to +125°C |

Specifications subject to change without notice.

OUTLINE DIMENSIONS (Inch/mm)

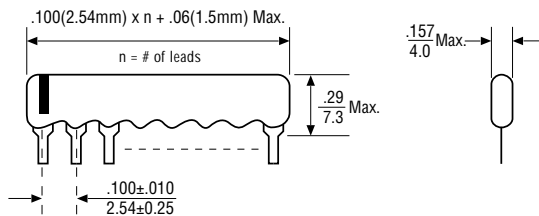

SCHEMATICS (COMMON CATHODE TYPE)

-1 Circuit

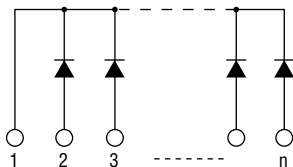

-2 Circuit

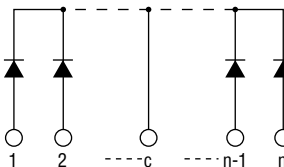

-3 Circuit

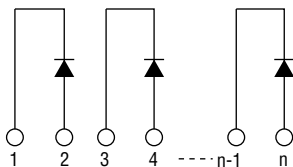

-5 Circuit

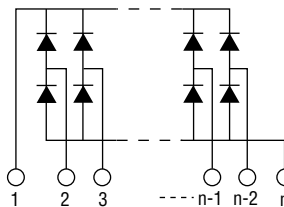

TYPICAL PART MARKING

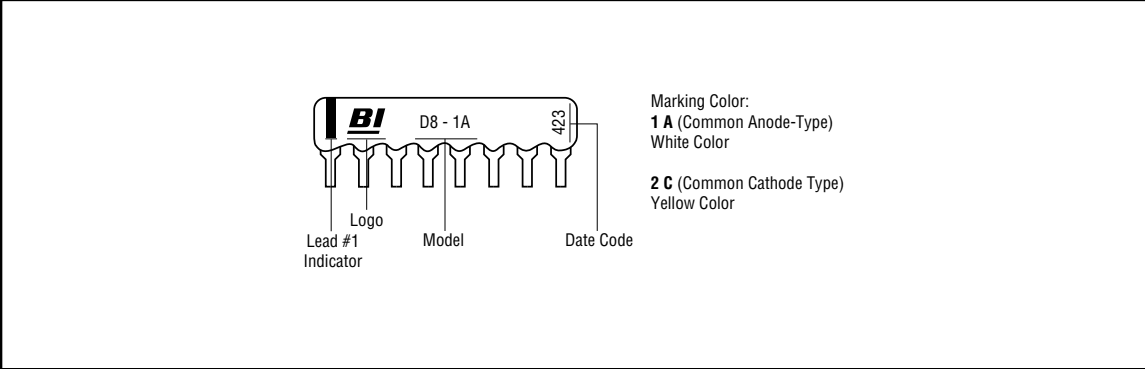

ORDERING INFORMATION

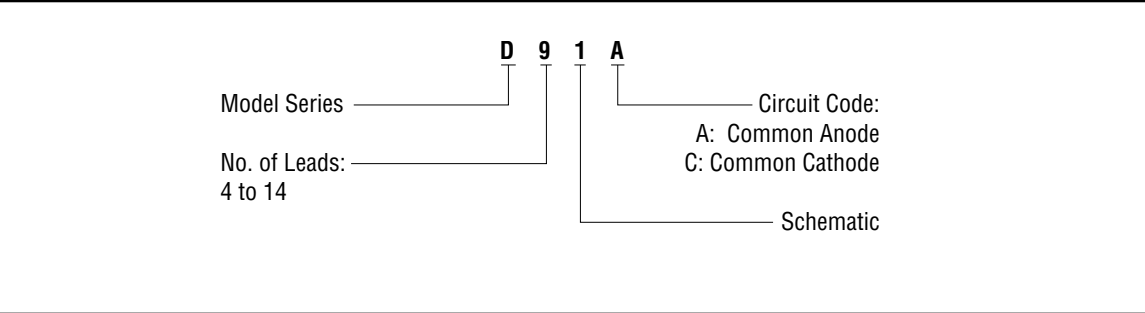

4