

2SB1123 / 2SD1623



High-Current Switching Applications

Applications

- Voltage regulators, relay drivers, lamp drivers, electrical equipment.

Features

- Adoption of FBET, MBIT processes.
- Low collector-to-emitter saturation voltage.
- Large current capacity and wide ASO.
- Fast switching speed.
- The ultraminiature package facilitates higher-density mounting, thus allows the applied hybrid IC's further miniaturization.

Specifications

() : 2SB1123

Absolute Maximum Ratings at Ta=25°C

Parameter	Symbol	Conditions	Ratings	Unit
Collector-to-Base Voltage	V _{CB0}		(-)60	V
Collector-to-Emitter Voltage	V _{CEO}		(-)50	V
Emitter-to-Base Voltage	V _{EBO}		(-)6	V
Collector Current	I _C		(-)2	A
Collector Current (Pulse)	I _{CP}		(-)4	A
Collector Dissipation	PC		0.5	W
		Mounted on a ceramic board (250mm ² X0.8mm)	1.3	W
Junction Temperature	T _J		150	°C
Storage Temperature	T _{stg}		-55 to +150	°C

Package Dimensions

unit : mm
2038A

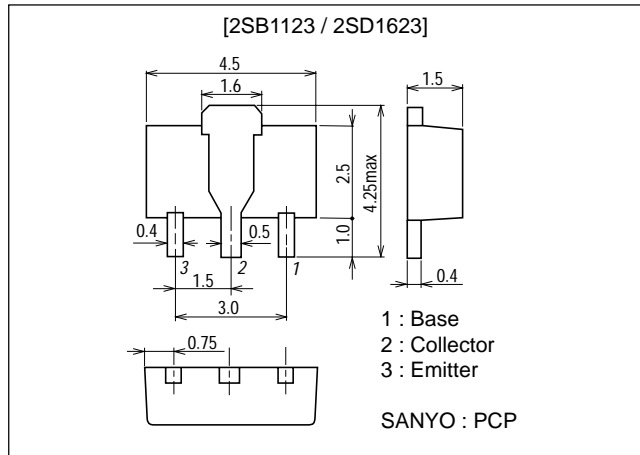

Electrical Characteristics at Ta=25°C

Parameter	Symbol	Conditions	Ratings			Unit
			min	typ	max	
Collector Cutoff Current	I _{CB0}	V _{CB} =(-)50V, I _E =0			(-)100	nA
Emitter Cutoff Current	I _{EBO}	V _{EB} =(-)4V, I _C =0			(-)100	nA
DC Current Gain	h _{FE} (1)	V _{CE} =(-)2V, I _C =(-)100mA	100*		560*	
	h _{FE} (2)	V _{CE} =(-)2V, I _C =(-)1.5A	40			

* : The 2SB1123 / 2SD1623 are classified by 100mA h_{FE} as follows :

Rank	R	S	T	U
h _{FE}	100 to 200	140 to 280	200 to 400	280 to 560

Marking 2SB1123 : BF
2SD1623 : DF

Continued on next page.

- Any and all SANYO products described or contained herein do not have specifications that can handle applications that require extremely high levels of reliability, such as life-support systems, aircraft's control systems, or other applications whose failure can be reasonably expected to result in serious physical and/or material damage. Consult with your SANYO representative nearest you before using any SANYO products described or contained herein in such applications.
- SANYO assumes no responsibility for equipment failures that result from using products at values that exceed, even momentarily, rated values (such as maximum ratings, operating condition ranges, or other parameters) listed in products specifications of any and all SANYO products described or contained herein.

2SB1123 / 2SD1623

Continued from preceding page.

Parameter	Symbol	Conditions	Ratings			Unit
			min	typ	max	
Gain-Bandwidth Product	f_T	$V_{CE}=(-)10V, I_C=(-)50mA$		150		MHz
Output Capacitance	C_{ob}	$V_{CB}=(-)10V, f=1MHz$		(22)12		pF
Collector-to-Emitter Saturation Voltage	$V_{CE(sat)}$	$I_C=(-)1A, I_B=(-)50mA$		(-0.3)0.15	(-0.7)0.4	V
Base-to-Emitter Saturation Voltage	$V_{BE(sat)}$	$I_C=(-)1A, I_B=(-)50mA$		(-)0.9	(-)1.2	V
Collector-to-Base Breakdown Voltage	$V_{(BR)CBO}$	$I_C=(-)10\mu A, I_E=0$	(-)60			V
Collector-to-Emitter Breakdown Voltage	$V_{(BR)CEO}$	$I_C=(-)1mA, R_{BE}=\infty$	(-)50			V
Emitter-to-Base Breakdown Voltage	$V_{(BR)EBO}$	$I_E=(-)10\mu A, I_C=0$	(-)6			V
Turn-ON Time	t_{on}	See specified Test Circuit.		(60)60		ns
Storage Time	t_{stg}	See specified Test Circuit.		(450)550		ns
Fall Time	t_f	See specified Test Circuit.		(30)30		ns

Switching Time Test Circuit

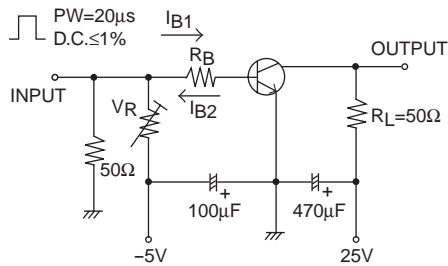

$10I_{B1} = -10I_{B2} = I_C = 500mA$
 (For PNP, the polarity is reversed)

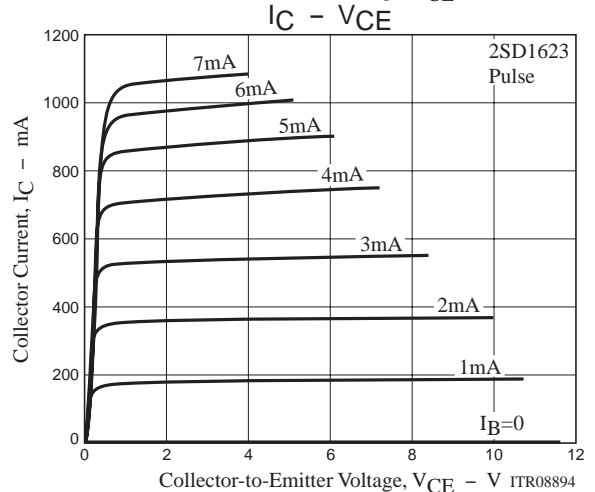
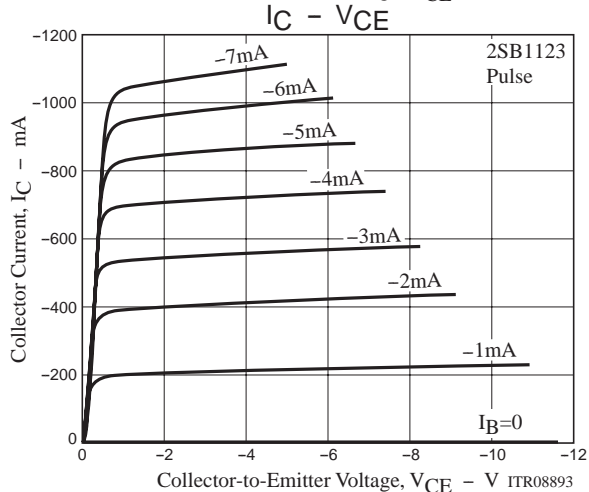
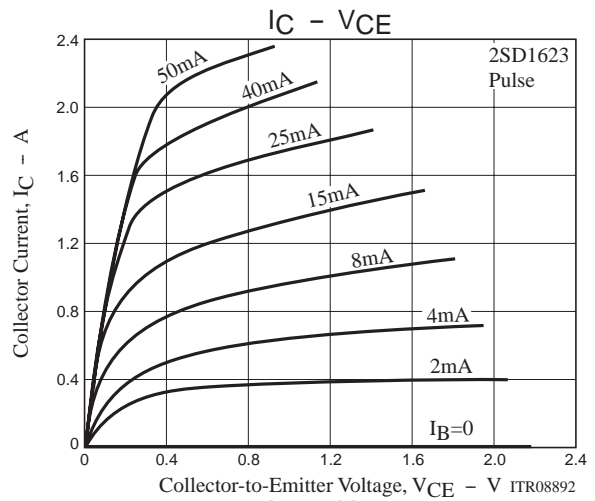
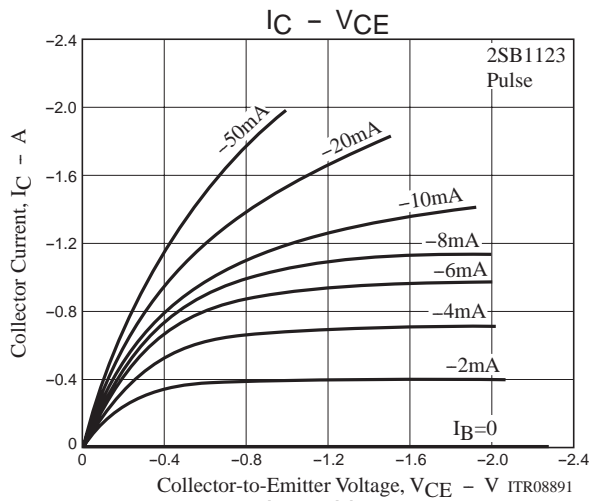

2SB1123 / 2SD1623

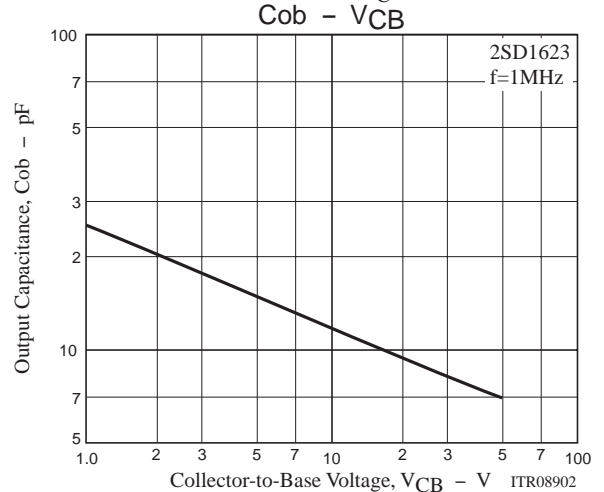
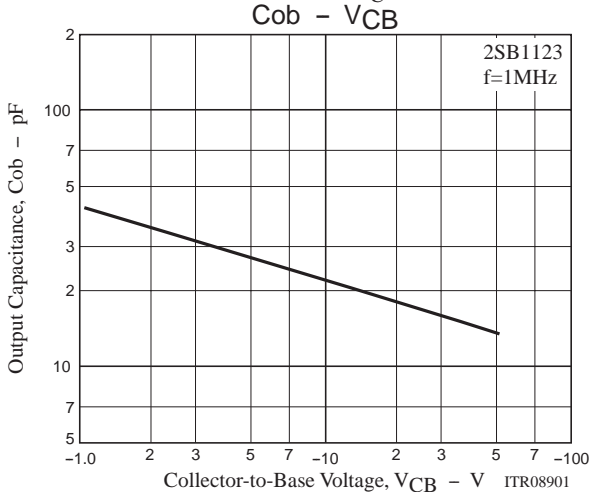
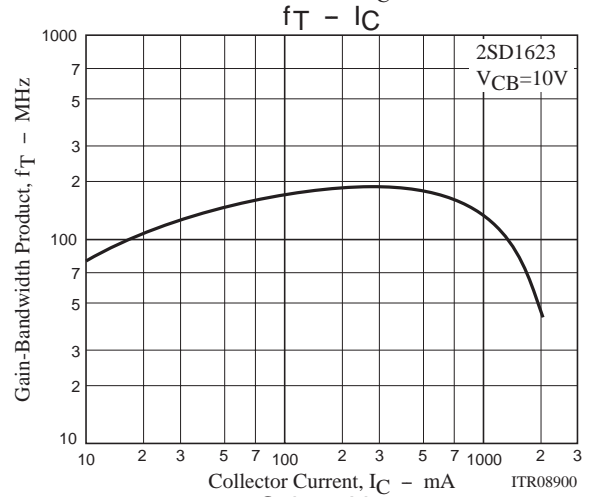
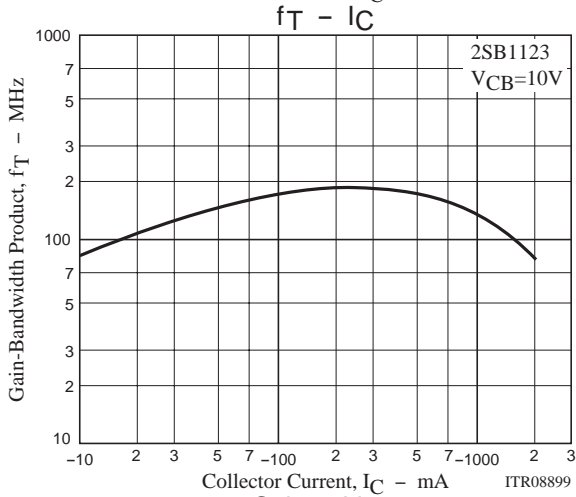
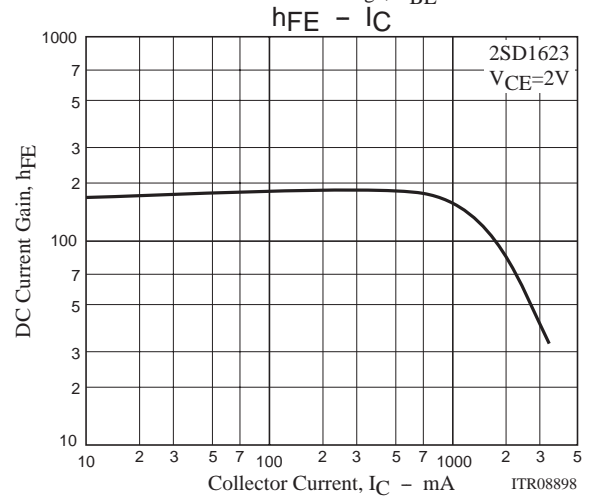
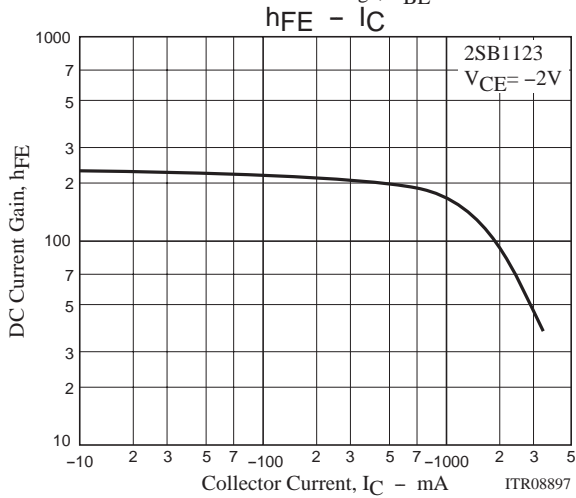
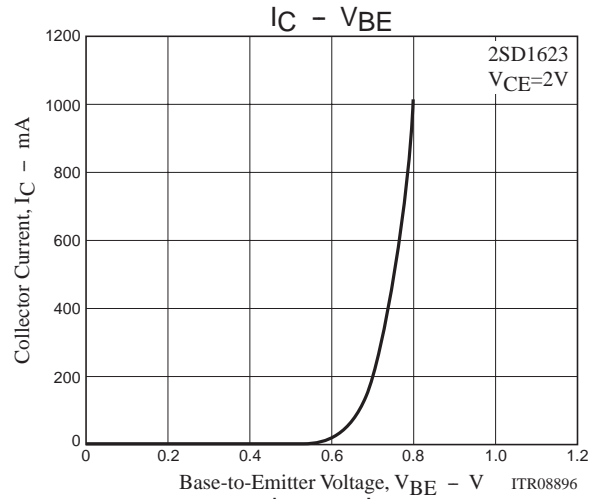
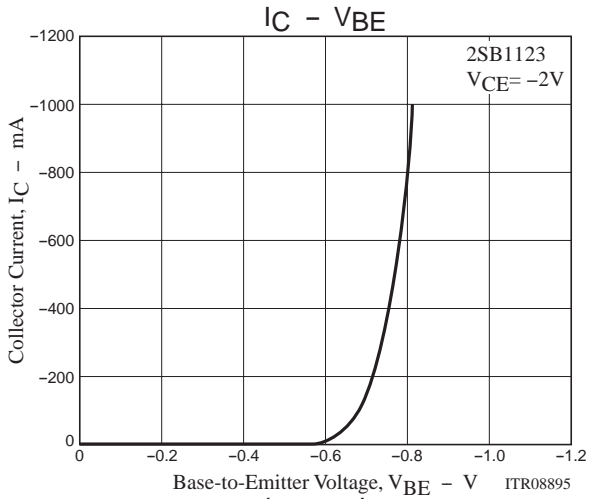

2SB1123 / 2SD1623

