

# SHINDENGEN

## Darlington Transistor

# 2SD1795

(TP10K40)

## 10A NPN

### OUTLINE DIMENSIONS

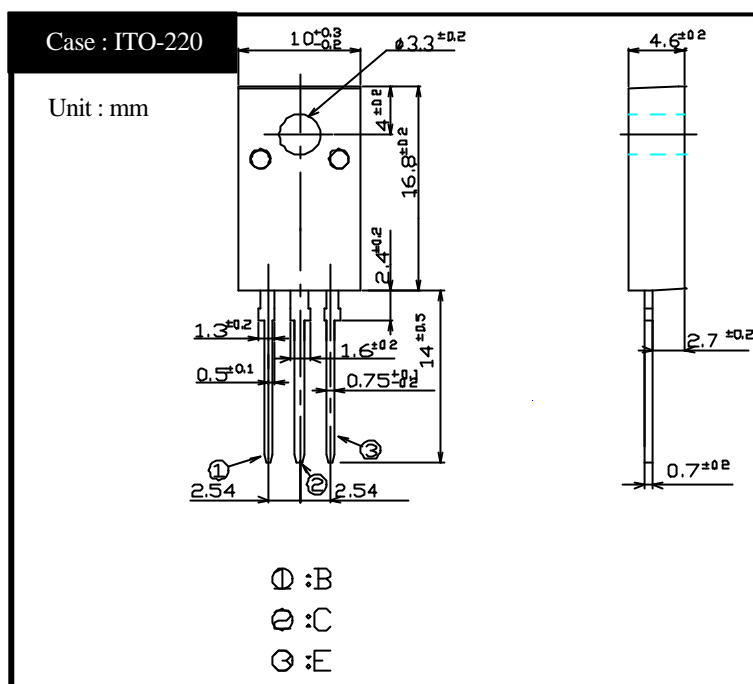

### RATINGS

#### Absolute Maximum Ratings

Item	Symbol	Conditions	Ratings	Unit
Storage Temperature	T <sub>stg</sub>		-55 ~ +150	
Junction Temperature	T <sub>j</sub>		+150	
Collector to Base Voltage	V <sub>CB0</sub>		500	V
Collector to Emitter Voltage	V <sub>CEO</sub>		400	V
Emitter to Base Voltage	V <sub>EBO</sub>		12	V
Collector Current DC	I <sub>C</sub>		10	A
Collector Current Peak	I <sub>CP</sub>		15	A
Base Current DC	I <sub>B</sub>		0.5	A
Base Current Peak	I <sub>BP</sub>		1.0	A
Total Transistor Dissipation	P <sub>T</sub>	T <sub>C</sub> = 25	50	W
Dielectric Strength	V <sub>dis</sub>	Terminals to case AC 1 minute	2	kV
Mounting Torque	TOR	(Recommended torque : 0.3N·m)	0.5	N·m

#### Electrical Characteristics (T<sub>C</sub>=25 )

Item	Symbol	Conditions	Ratings	Unit
Collector to Emitter Sustaining Voltage	V <sub>CEO</sub>	V <sub>CE</sub> (Clamp)	Min 400	V
Collector Cutoff Current	I <sub>CBO</sub>	V <sub>CB</sub> = 500V	Max 0.1	mA
	I <sub>CEO</sub>	V <sub>CE</sub> = 400V	Max 0.1	
Emitter Cutoff Current	I <sub>EBO</sub>	V <sub>EB</sub> = 12V	Max 100	mA
DC Current Gain	h <sub>FE</sub>	V <sub>CE</sub> = 2V, I <sub>C</sub> = 7A	Min 150	
Collector to Emitter Saturation Voltage	V <sub>CE(sat)</sub>	I <sub>C</sub> = 7A	Max 1.5	V
Base to Emitter Saturation Voltage	V <sub>BE(sat)</sub>	I <sub>B</sub> = 70mA	Max 2.0	V
Thermal Resistance	θ <sub>jc</sub>	Junction to case	Max 2.5	/W
Transition Frequency	f <sub>T</sub>	V <sub>CE</sub> = 10V, I <sub>C</sub> = 1A	TYP 10	MHz
Turn on Time	t <sub>on</sub>		Max 2	μs
Storage Time	t <sub>s</sub>	I <sub>C</sub> = 7A I <sub>B1</sub> = I <sub>B2</sub> = 70mA R <sub>L</sub> = 10	Max 15	
Fall Time	t <sub>f</sub>	V <sub>BB2</sub> = 4V	Max 15	

# 2SD1795

$h_{FE} - I_C$

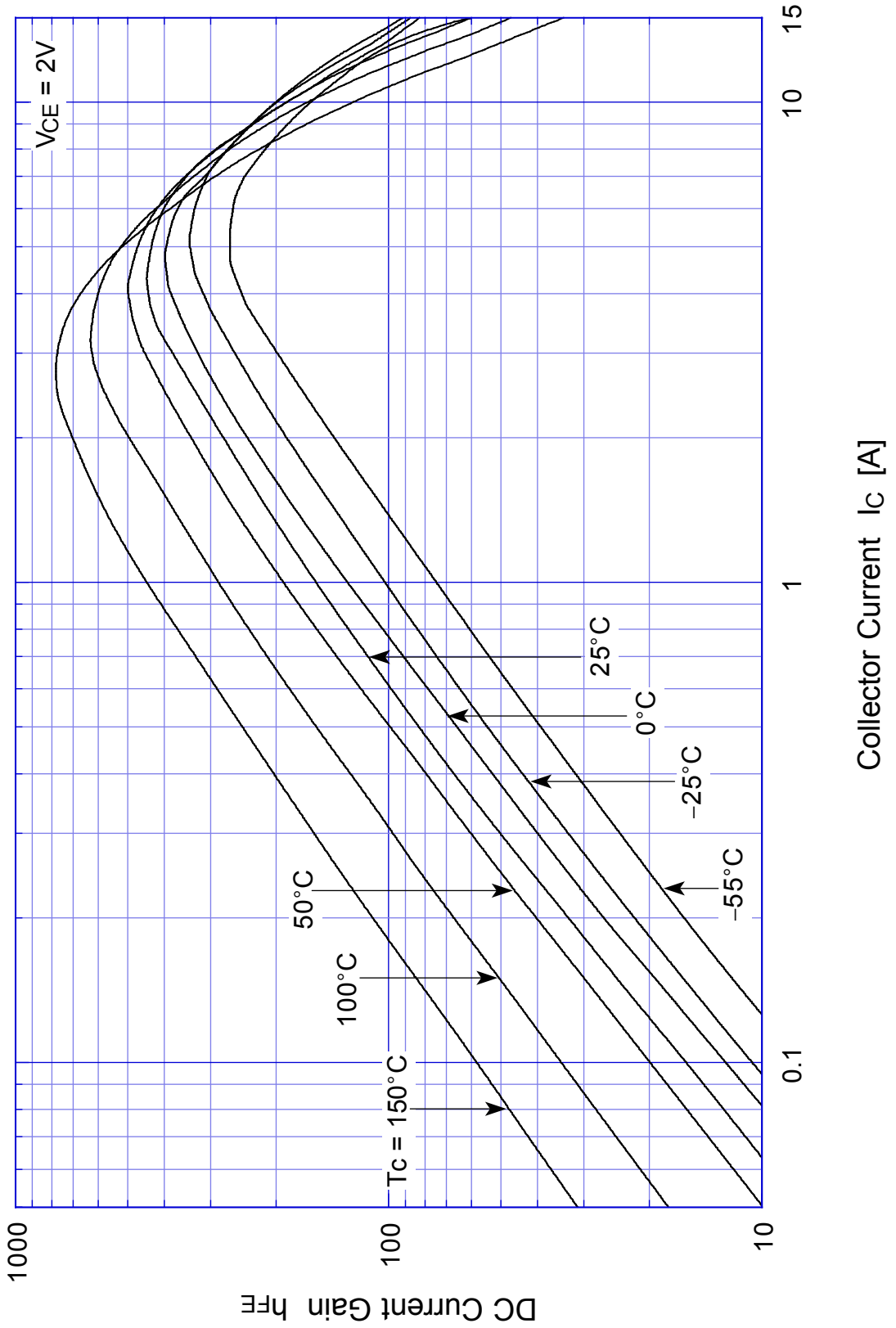

# 2SD1795 Saturation Voltage

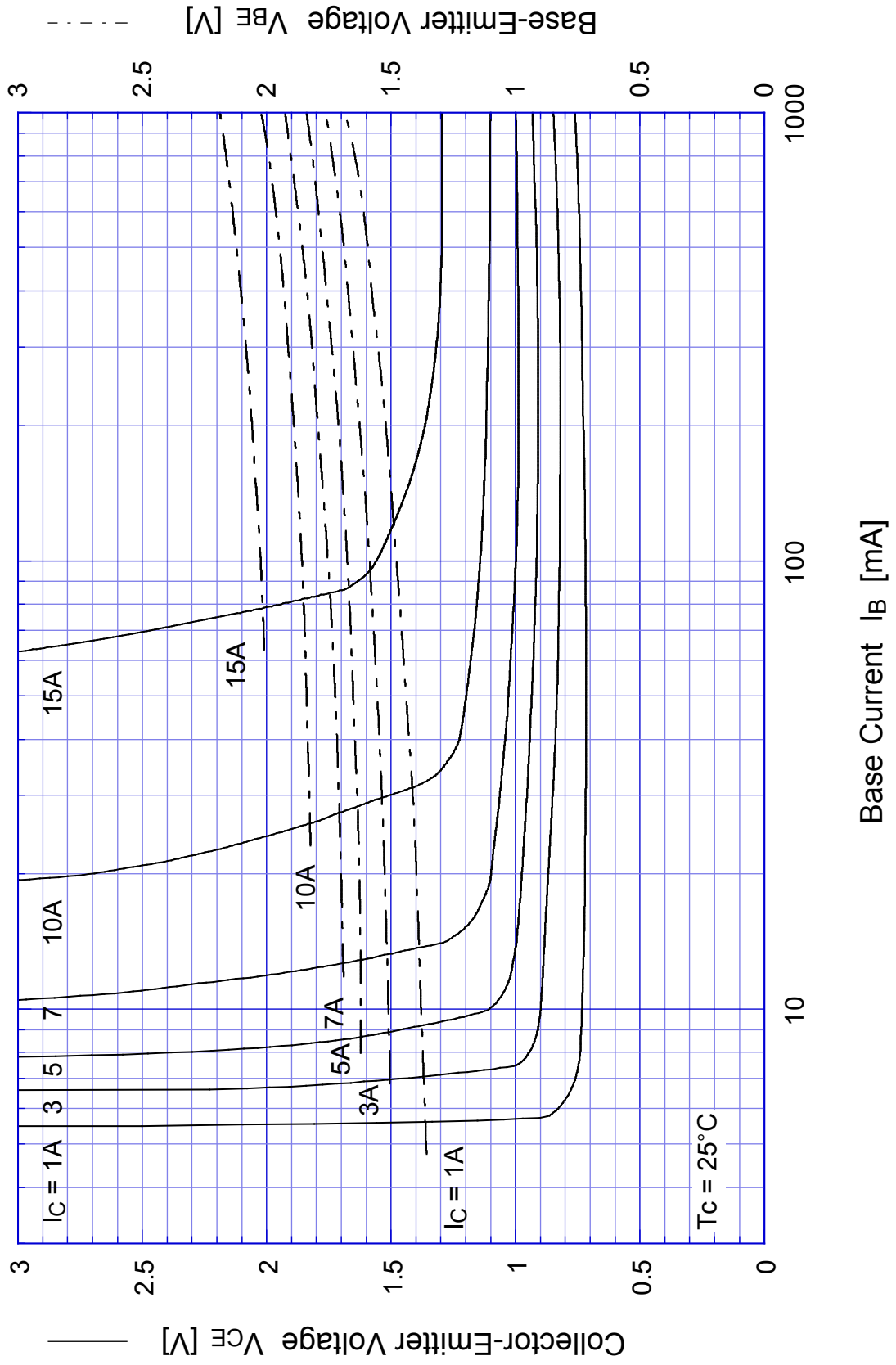

## 2SD1795 Switching Time - $I_C$

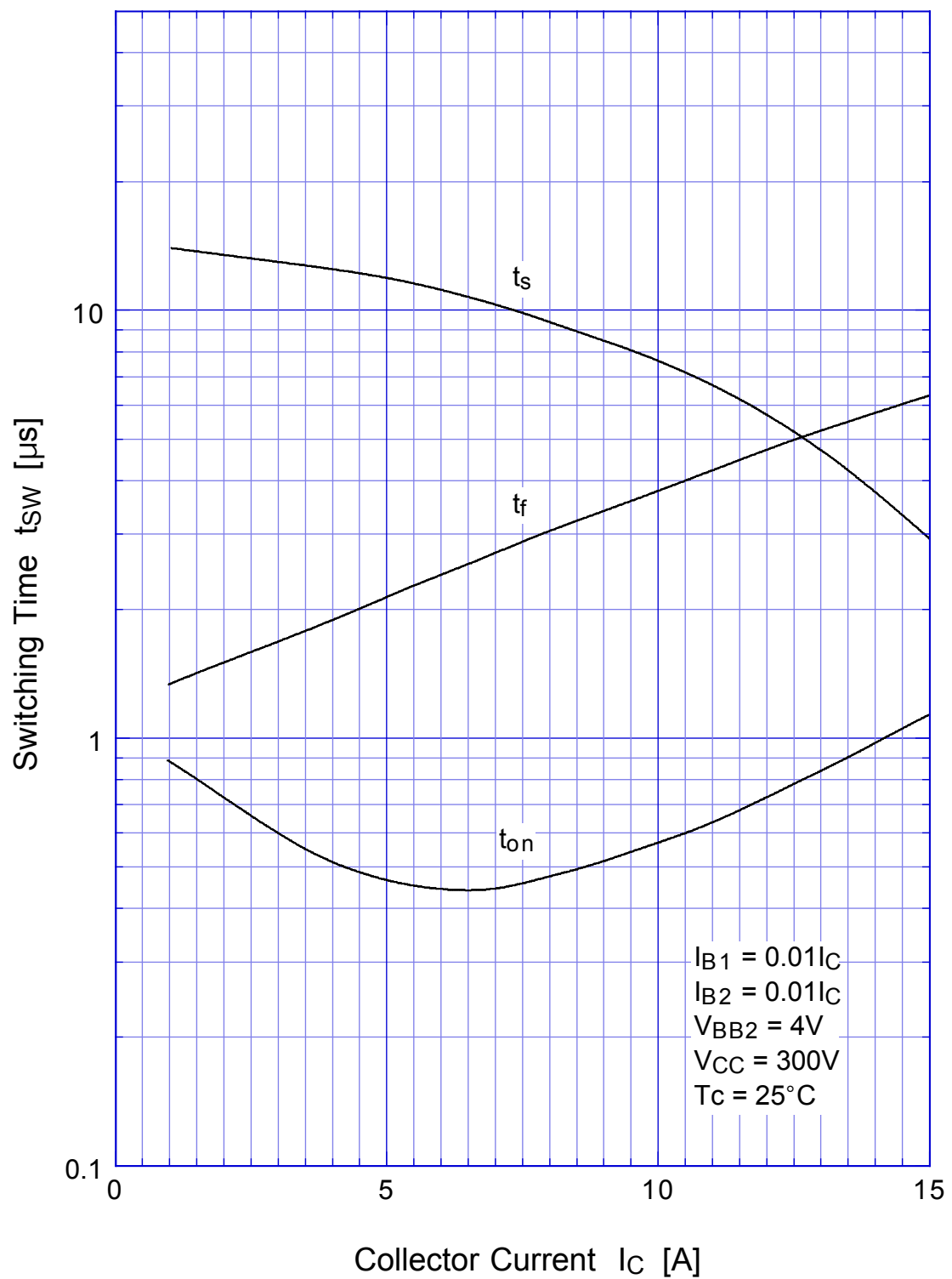

## 2SD1795 Switching Time - Tc

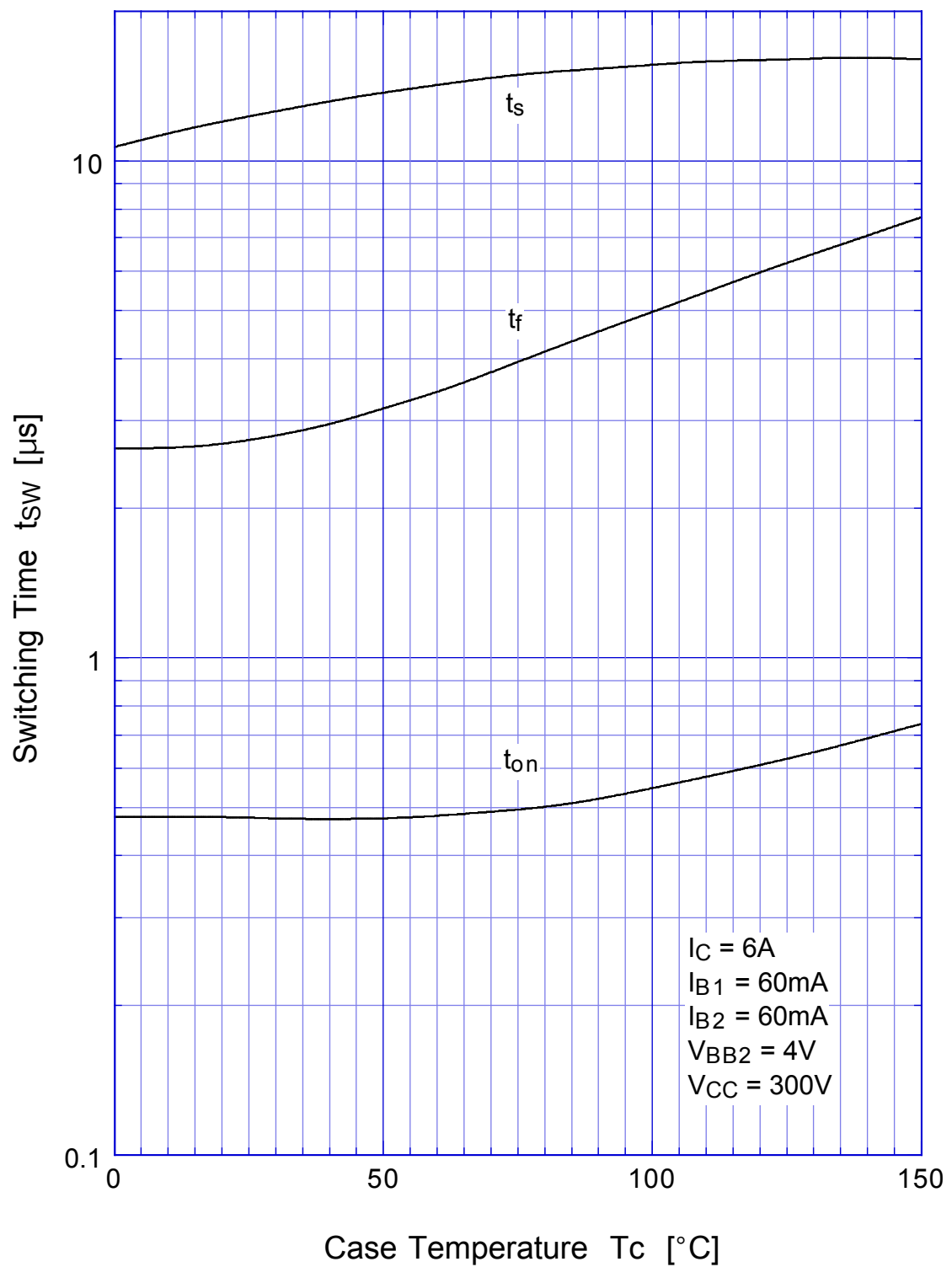

### 2SD1795 Transient Thermal Impedance

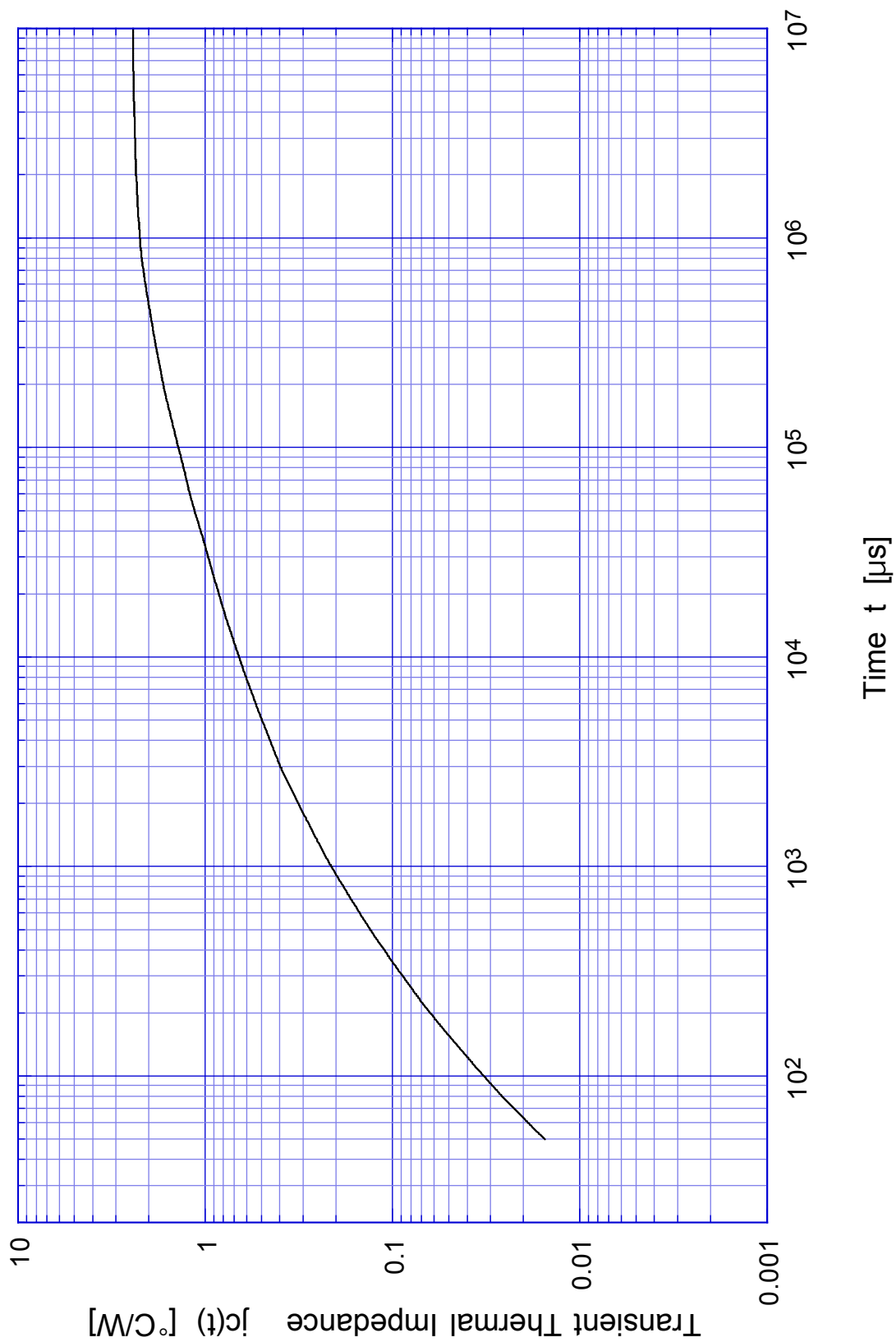

## 2SD1795 Forward Bias SOA

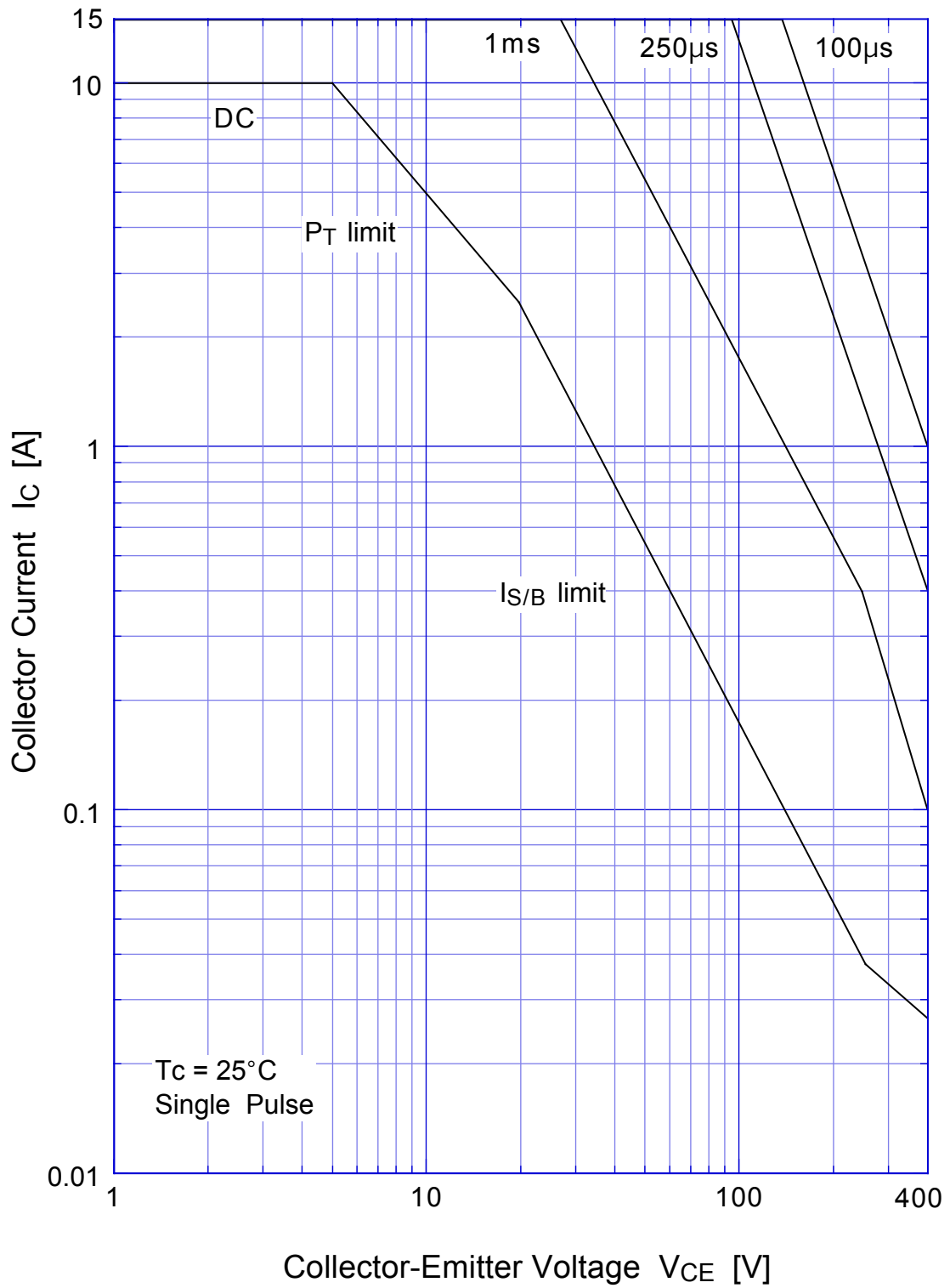

## 2SD1795 Collector Current Derating

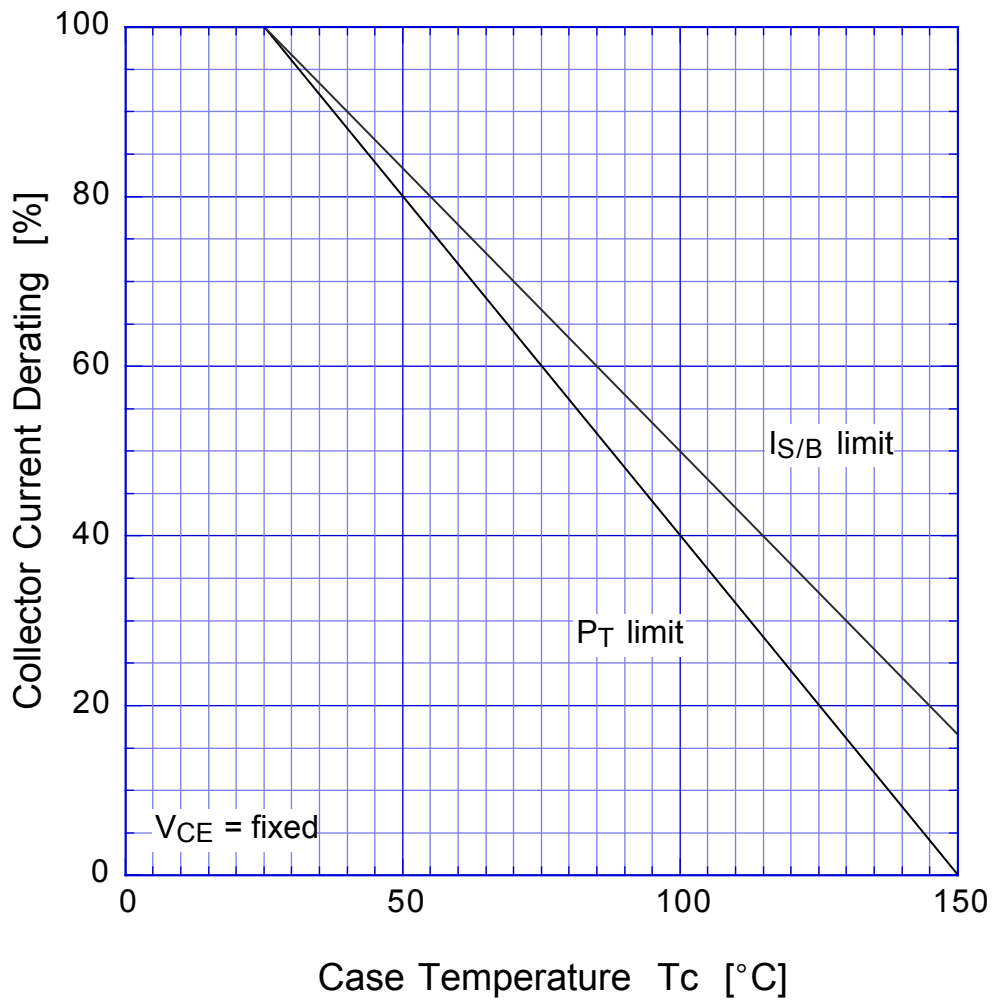



## 2SD1795 Reverse Bias SOA

