

# SHINDENGEN

## Darlington Transistor

**2SD2196**  
**(TP15L20)**

**15A NPN**

### OUTLINE DIMENSIONS

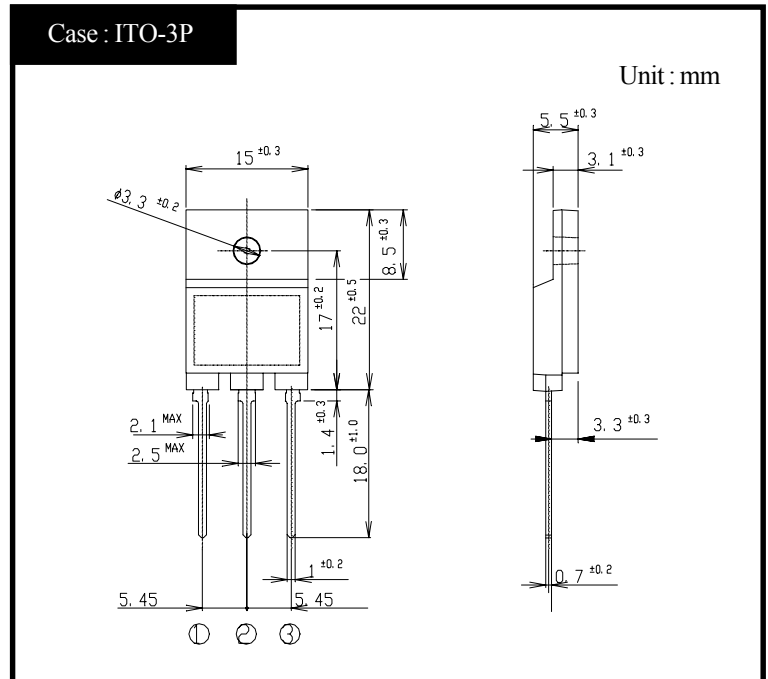

### RATINGS

#### ● Absolute Maximum Ratings

Item	Symbol	Conditions	Ratings	Unit
Storage Temperature	T <sub>stg</sub>		-55~+150	°C
Junction Temperature	T <sub>j</sub>		+150	°C
Collector to Base Voltage	V <sub>CB0</sub>		200	V
Collector to Emitter Voltage	V <sub>CEO</sub>		200	V
Emitter to Base Voltage	V <sub>EBO</sub>		7	V
Collector Current DC	I <sub>C</sub>		15	A
Collector Current Peak	I <sub>CP</sub>		22	A
Base Current DC	I <sub>B</sub>		1	A
Base Current Peak	I <sub>BP</sub>		2	A
Total Transistor Dissipation	P <sub>T</sub>	T <sub>c</sub> = 25°C	65	W
Dielectric Strength	V <sub>dis</sub>	Terminals to case AC 1 minute	2	kV
Mounting Torque	TOR	(Recommended torque : 0.5N·m)	0.8	N·m

#### ● Electrical Characteristics (T<sub>c</sub>=25°C)

Item	Symbol	Conditions	Ratings	Unit
Collector Cutoff Current	I <sub>CB0</sub>	V <sub>CB</sub> = 200V	Max 0.1	mA
	I <sub>CEO</sub>	V <sub>CE</sub> = 200V	Max 0.1	
Emitter Cutoff Current	I <sub>EBO</sub>	V <sub>EB</sub> = 7V	Max 5	mA
DC Current Gain	h <sub>FE</sub>	V <sub>CE</sub> = 3V, I <sub>C</sub> = 10A	Min 1,500	
			Max 30,000	
Collector to Emitter Saturation Voltage	V <sub>CE(sat)</sub>	I <sub>C</sub> = 10A	Max 1.5	V
Base to Emitter Saturation Voltage	V <sub>BE(sat)</sub>	I <sub>B</sub> = 30mA	Max 2.0	V
Thermal Resistance	θ <sub>jc</sub>	Junction to case	Max 1.92	°C/W
Transition Frequency	f <sub>T</sub>	V <sub>CE</sub> = 10V, I <sub>C</sub> = 1.5A	TYP 20	MHz
Turn on Time	ton		Max 2	μs
Storage Time	ts	I <sub>C</sub> = 10A I <sub>B1</sub> = I <sub>B2</sub> = 30mA R <sub>L</sub> = 3 Ω	Max 12	
Fall Time	tf	V <sub>BB2</sub> = 4V	Max 5	

# 2SD2196 $h_{FE} - I_c$

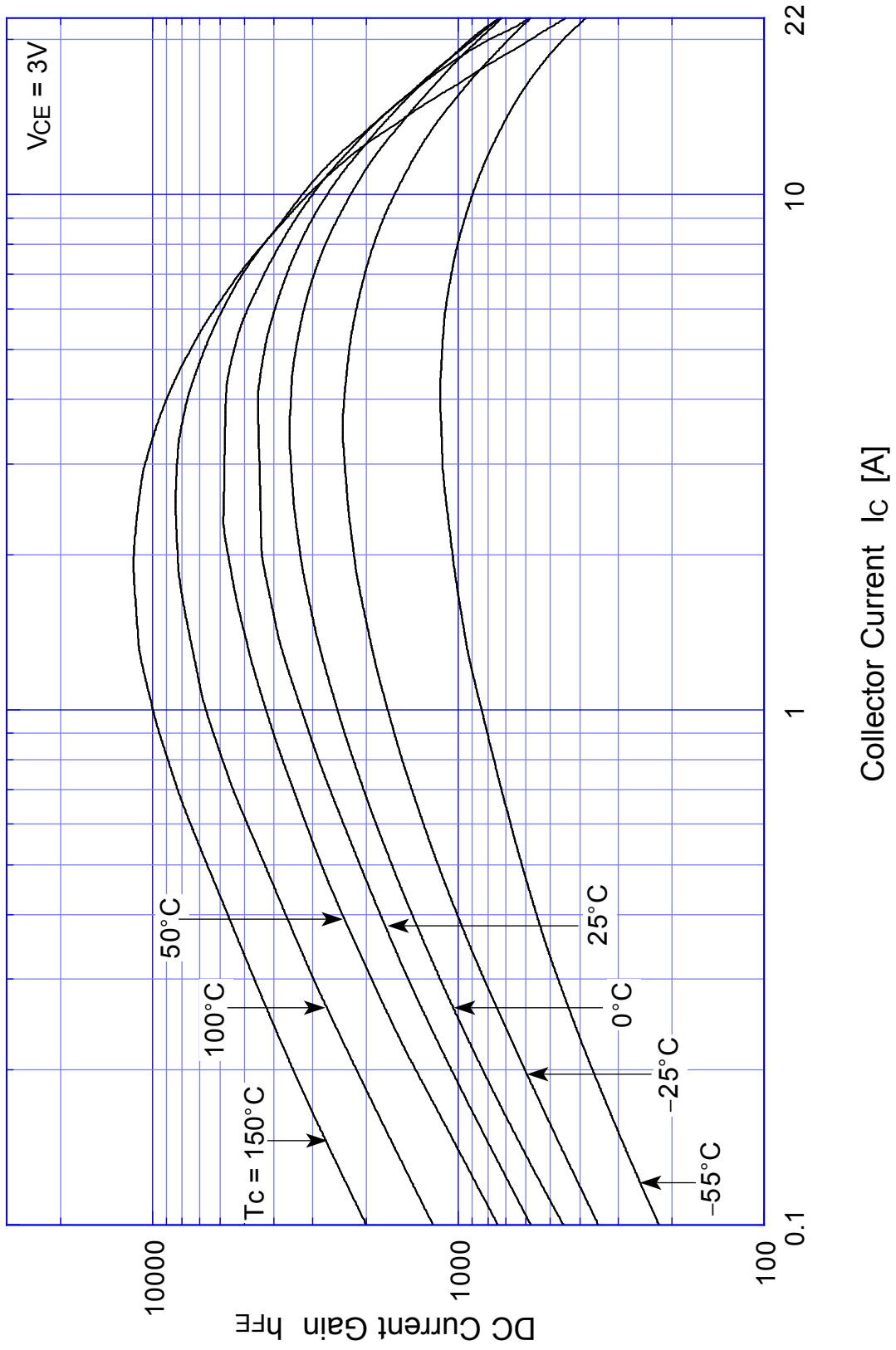

# 2SD2196 Saturation Voltage

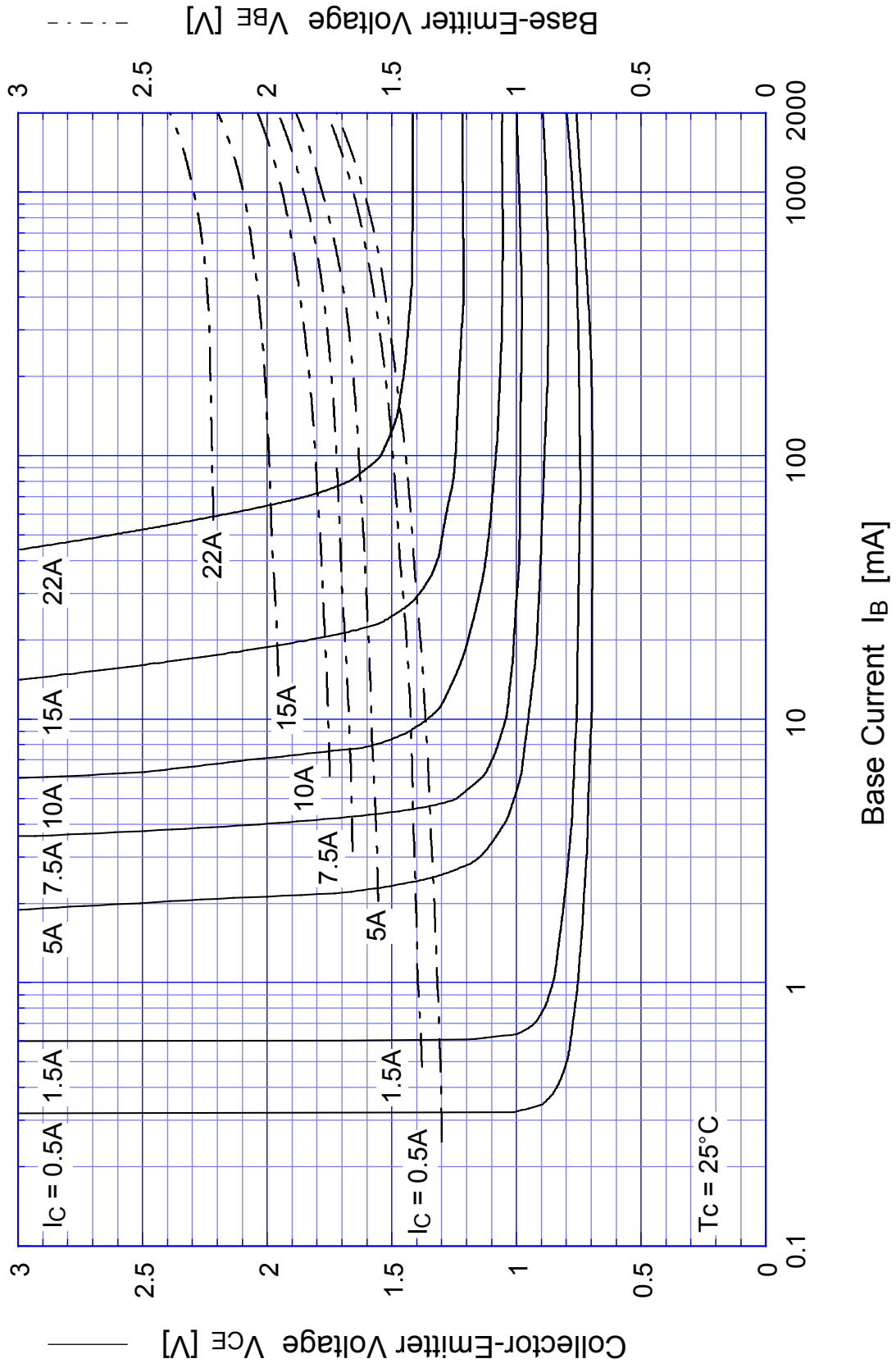

# 2SD2196

## Switching Time - $I_C$

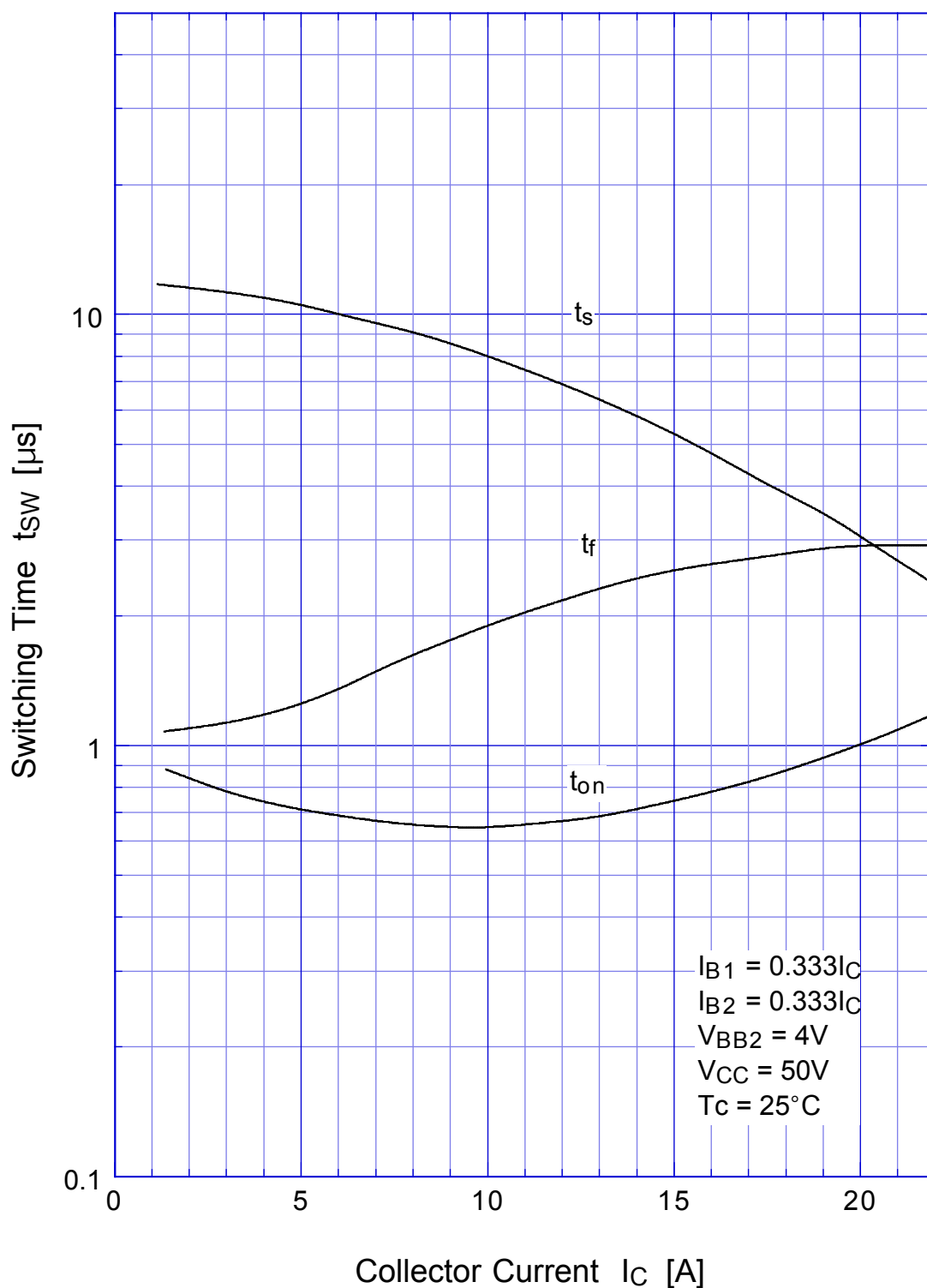

# 2SD2196

# Switching Time

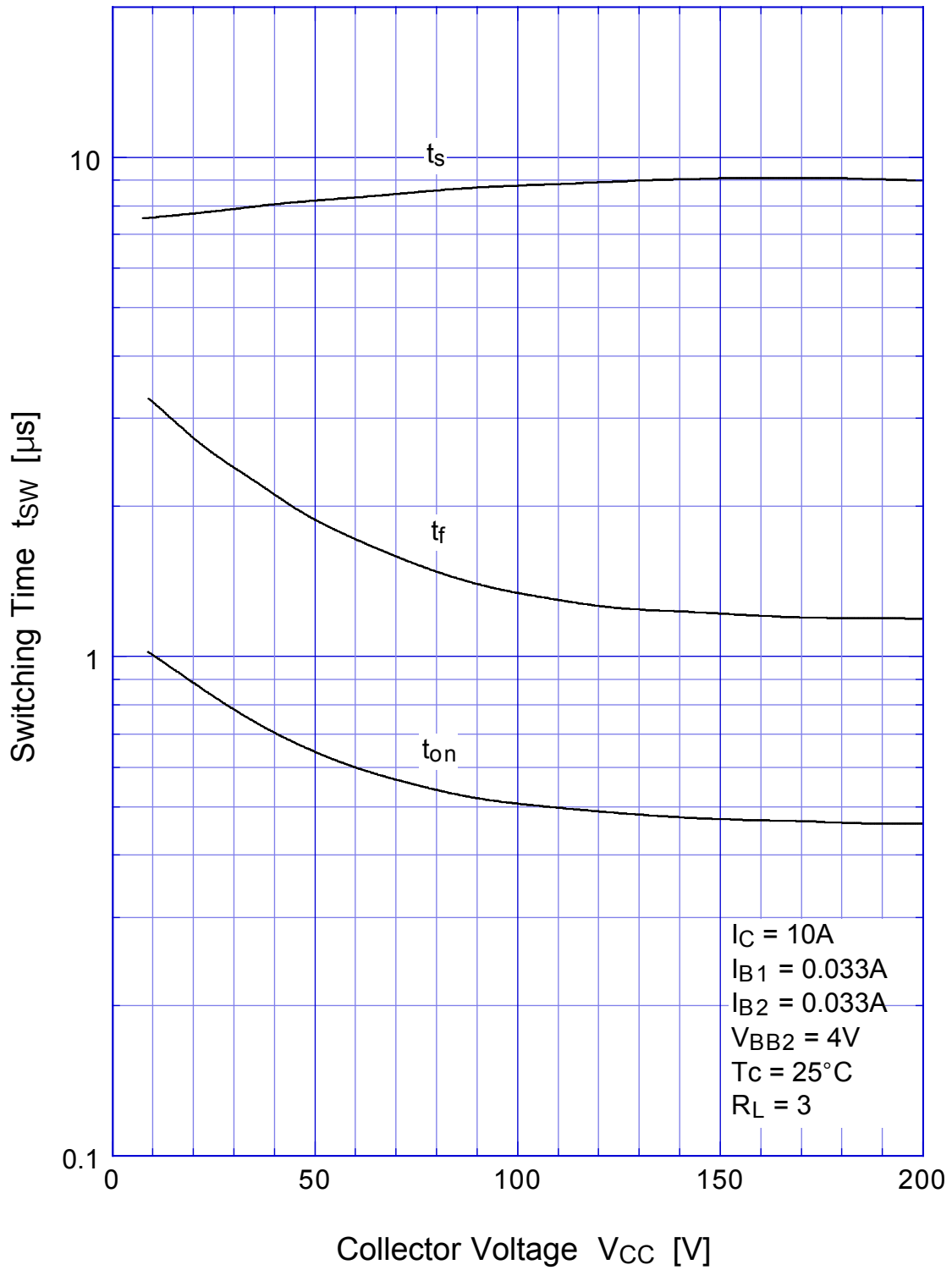

# 2SD2196

## Switching Time - Tc

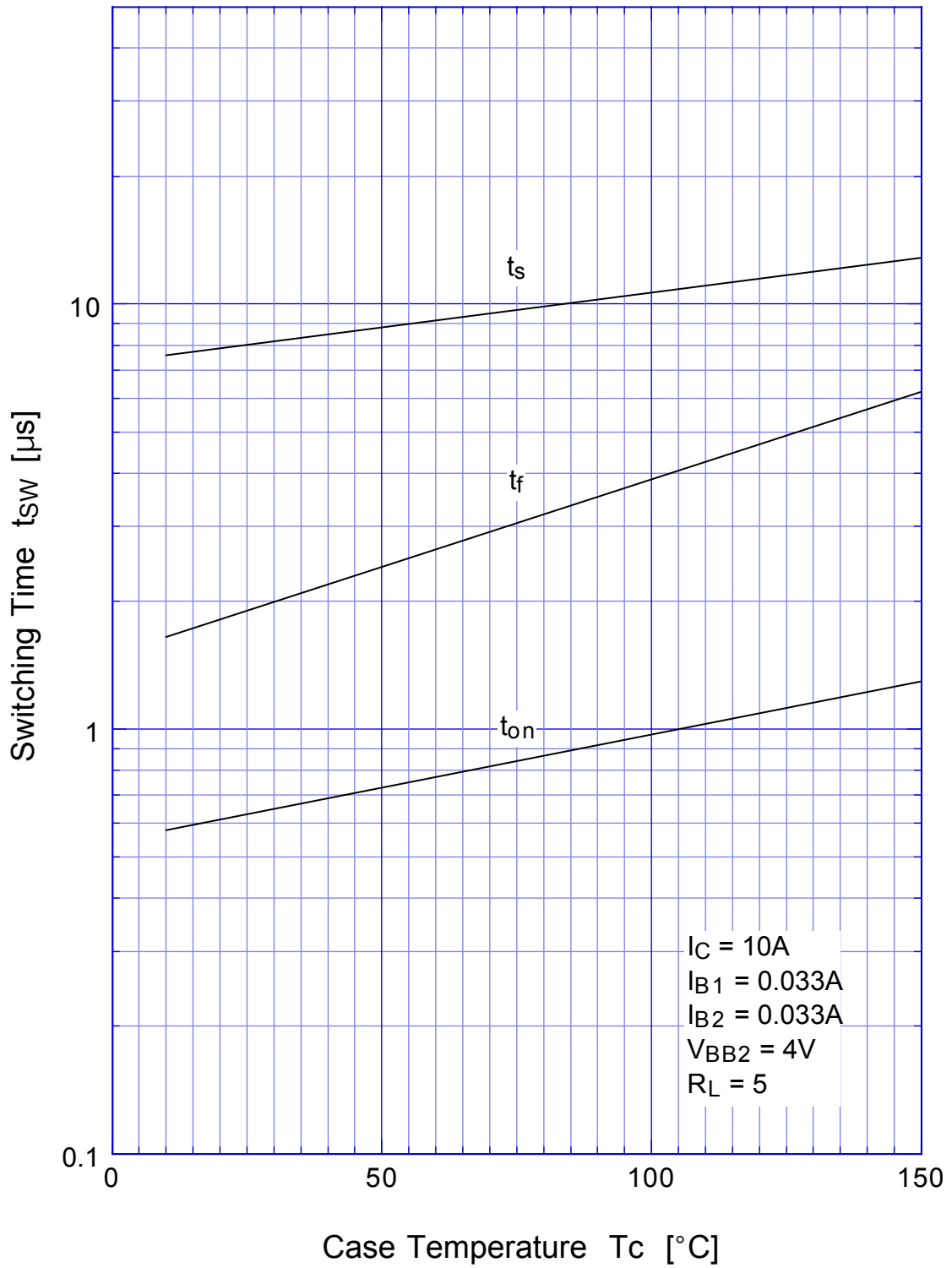

### 2SD2196 Transient Thermal Impedance

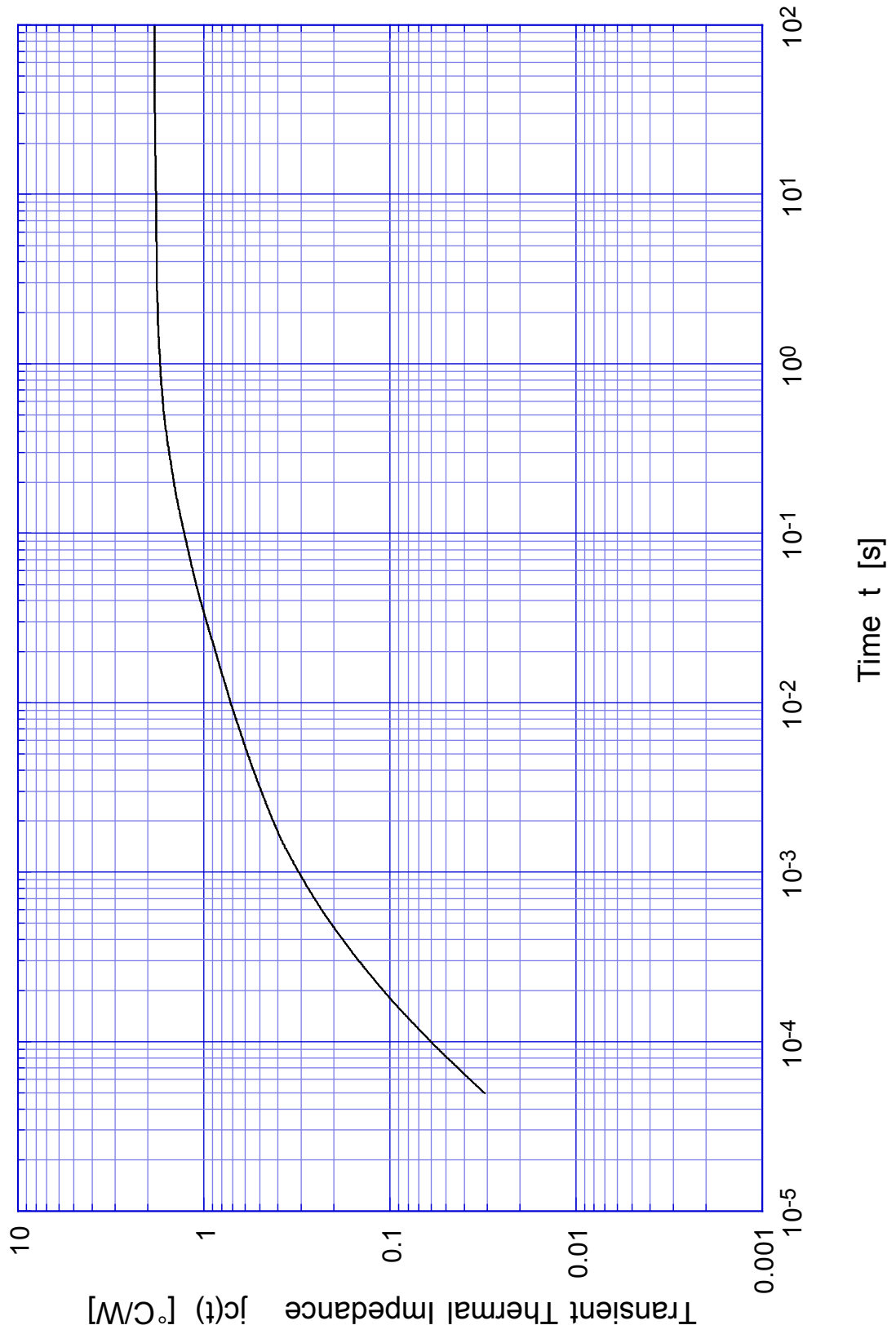

# 2SD2196

# Forward Bias SOA

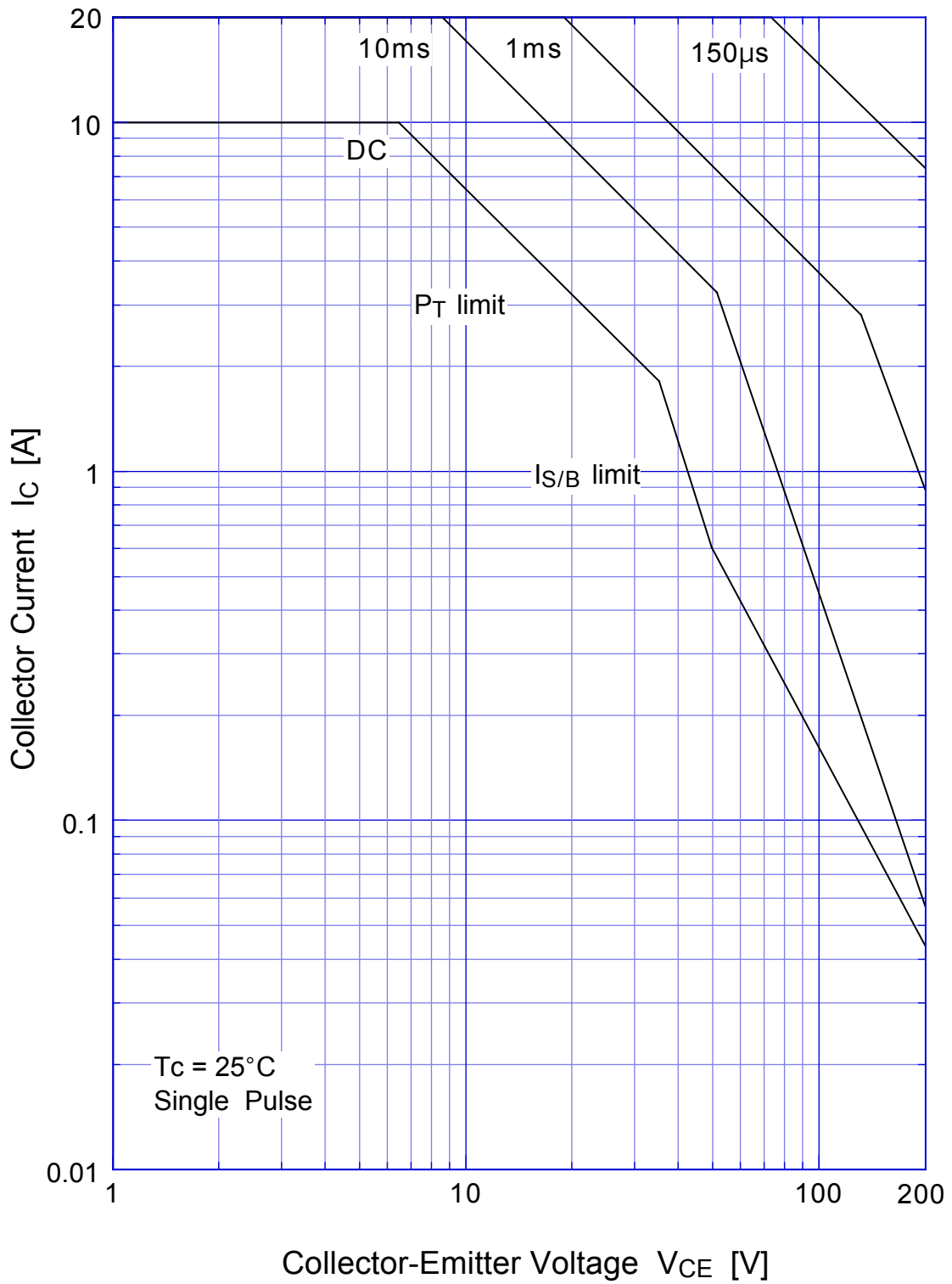



## 2SD2196 Collector Current Derating

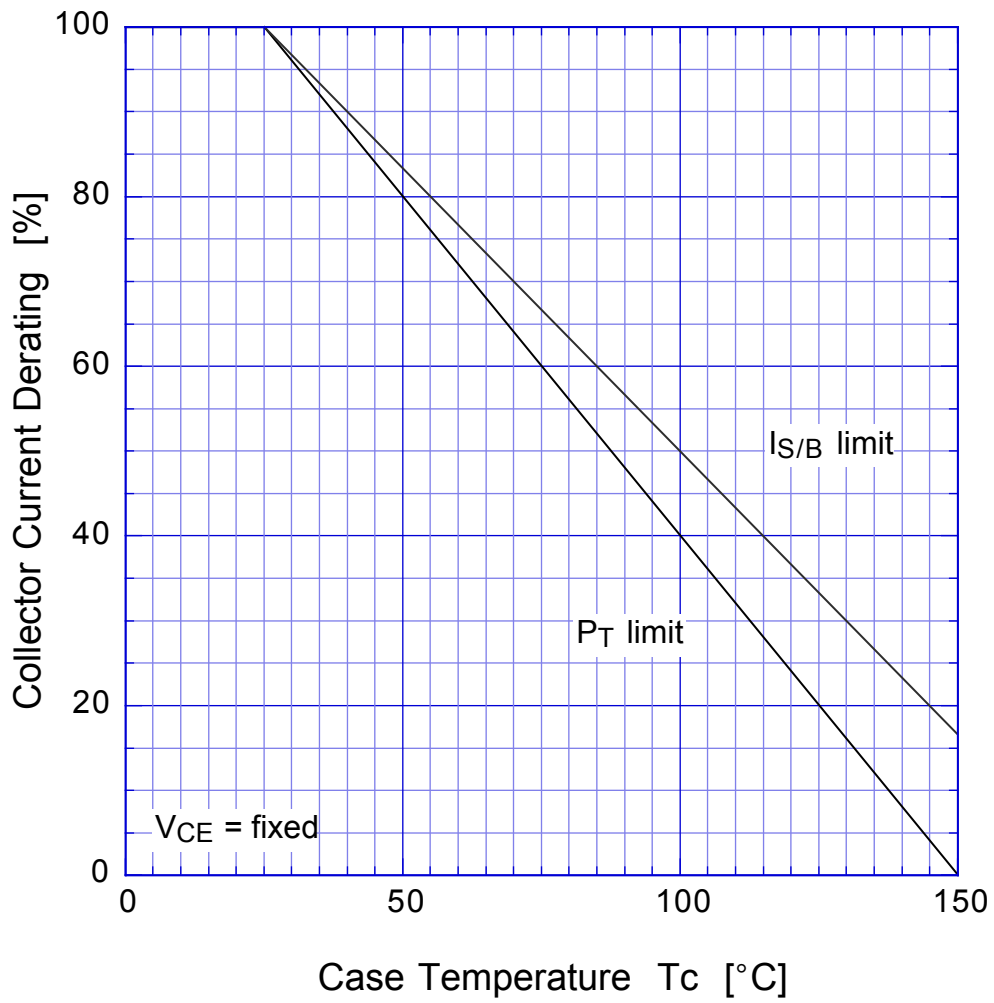

# 2SD2196

# Reverse Bias SOA

