



## Low Voltage Audio Power Amplifier D386

### DESCRIPTION

The D386 is a power amplifier designed for use in low voltage consumer applications. The gain is internally set to 20 to keep external part count low, but the addition of an external resistor and capacitor between pins 1 and 8 will increase the gain to any value from 20 to 200.

The inputs are ground referenced while the output automatically biases to one-half the supply voltage. The quiescent power drain is only 24 milliwatts when operating from a 6 volt supply, making the LM386 ideal for battery operation.

Outline Drawing

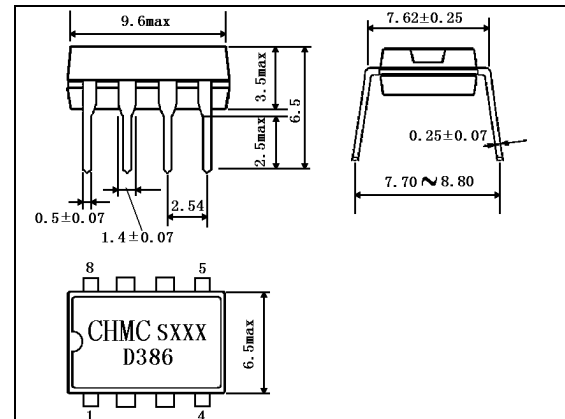

### FEATURE

DataSheet4U.com

DataSheet4U.com

- Battery operation
- Minimum external parts
- Wide supply voltage range: 4V–12V
- Low quiescent current drain: 4mA
- Voltage gains from 20 to 200
- Available in 8 pin DIP package

### APPLICATION

- AM-FM radio amplifiers
- Portable tape player amplifiers
- Intercoms
- TV sound systems
- Line drivers
- Ultrasonic drivers
- Small servo drivers
- Power converters

### PIN CONFIGURATION

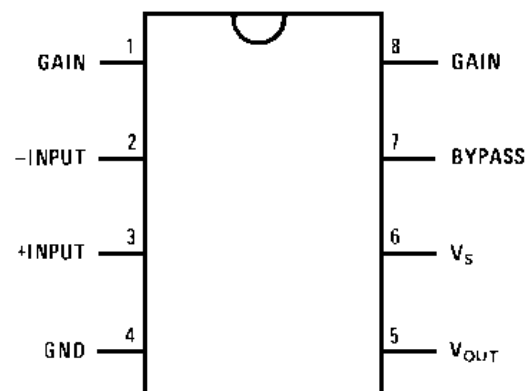

## EQUIVALENT SCHEMATIC AND CONNECTION DIAGRAMS

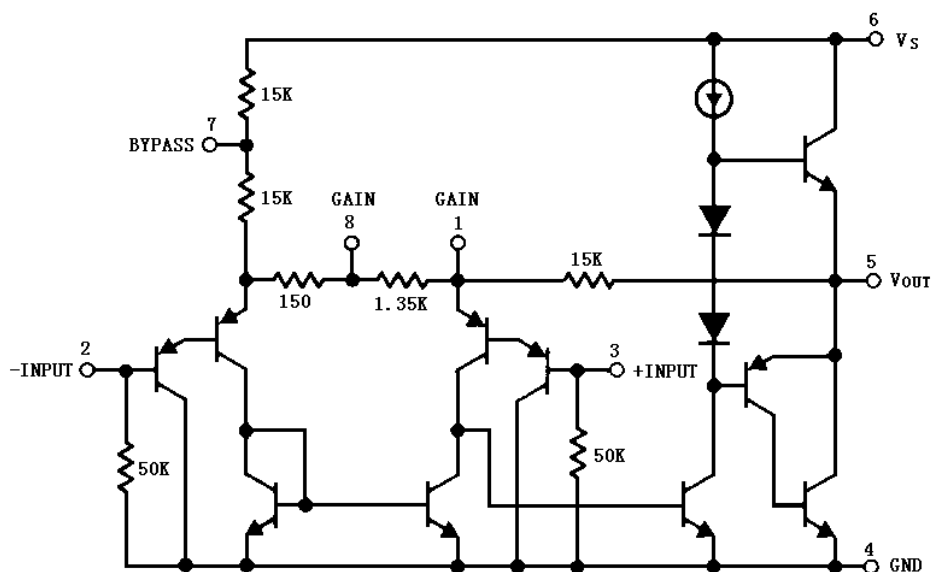

## ABSOLUTE MAXIMUM RATINGS (Ta=25°C)

Characteristic	Symbol	Value	Unit
Maximum Input Voltage	V <sub>IN</sub>	± 0.4	V
Supply Voltage	V <sub>CC</sub>	15	V
Maximum Power Dissipation	P <sub>D</sub>	660	mW
Soldering temperature(10 sec.)	T <sub>s</sub>	260	°C
Junction Temperature	T <sub>j</sub>	150	°C
Operating Temperature	T <sub>amb</sub>	-10~+70	°C
Storage Temperature	T <sub>stg</sub>	-40~125	°C

## ELECTRICAL CHARACTERISTICS

(Unless otherwise specified: V<sub>CC</sub>=6V, R<sub>L</sub>=8Ω, f=1kHz, T<sub>amb</sub>=25°C)

Characteristics	Test conditions	Symbol	Min	Typ	Max	Unit
Operating Supply Voltage		V <sub>CC</sub>			12	V
Quiescent Current	V <sub>CC</sub> =6V, V <sub>IN</sub> =0	I <sub>CC</sub>	-	4	8	mA
Output Power	V <sub>CC</sub> =6V, R <sub>L</sub> =8Ω, THD=10%	P <sub>o</sub>	250	325		mW
	V <sub>CC</sub> =9V, R <sub>L</sub> =8Ω, THD=10%		500	700		
Voltage Gain	V <sub>CC</sub> =6V, f=1kHz	A <sub>v</sub>	-	26	-	dB
	1脚、8脚间接 10μF 电容		-	46	-	
Bandwidth	V <sub>CC</sub> =6V, 脚 1、8 开路	BW	-	300	-	kHz
Total Harmonic Distortion	V <sub>CC</sub> =6V, R <sub>L</sub> =8Ω, P <sub>o</sub> =125mW, f=1kHz 脚 1、8 开路	THD	-	0.2	-	%
Power Supply Rejection Ratio	V <sub>CC</sub> =6V, f=1kHz, C <sub>BYPASS</sub> =10μF, 1、8脚开路、输出为参考	PSRR		50		dB
Input Resistance		R <sub>IN</sub>	-	50	-	k
Input Bias Current	V <sub>CC</sub> =6V, 2、3脚开路	I <sub>B</sub>	-	250	-	nA

**APPLICATION HINTS****GAIN CONTROL**

To make the D386 a more versatile amplifier, two pins (1 and 8) are provided for gain control. With pins 1 and 8 open the 1.35 kW resistor sets the gain at 20 (26 dB). If a capacitor is put from pin 1 to 8, bypassing the 1.35 kW resistor, the gain will go up to 200 (46 dB). If a resistor is placed in series with the capacitor, the gain can be set to any value from 20 to 200. Gain control can also be done by capacitively coupling a resistor (or FET) from pin 1 to ground.

Additional external components can be placed in parallel with the internal feedback resistors to tailor the gain and frequency response for individual applications. For example, we can compensate poor speaker bass response by frequency shaping the feedback path. This is done with a series RC from pin 1 to 5 (paralleling the internal 15 kW resistor). For 6 dB effective bass boost:  $R = 15 \text{ kW}$ , the lowest value for good stable operation is  $R = 10 \text{ kW}$  if pin 8 is open. If pins 1 and 8 are bypassed then  $R$  as low as 2 kW can be used. This restriction is because the amplifier is only compensated for closed-loop gains greater than 9.

**INPUT BIASING**

The schematic shows that both inputs are biased to ground with a 50 kW resistor. The base current of the input transistors is about 250 nA, so the inputs are at about 12.5 mV when left open. If the dc source resistance driving the D386 is higher than 250 kW it will contribute very little additional offset (about 2.5 mV at the input, 50 mV at the output). If the dc source resistance is less than 10 kW, then shorting the unused input to ground will keep the offset low (about 2.5 mV at the input, 50 mV at the output). For dc source resistances between these values we can eliminate excess offset by putting a resistor from the unused input to ground, equal in value to the dc source resistance. Of course all offset problems are eliminated if the input is capacitively coupled.

When using the D386 with higher gains (bypassing the 1.35 kW resistor between pins 1 and 8) it is necessary to bypass the unused input, preventing degradation of gain and possible instabilities. This is done with a 0.1  $\mu\text{F}$  capacitor or a short to ground depending on the dc source resistance on the driven input.

## APPLICATION CIRCUIT

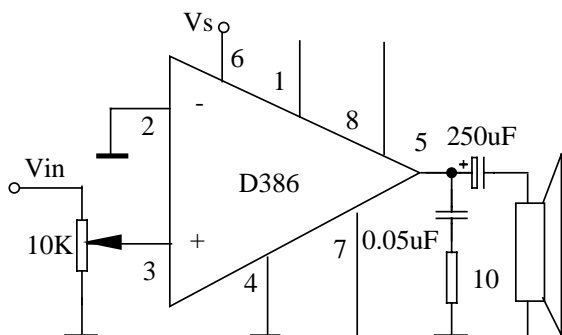

Fig1 Amplifier with Gain = 20  
(Minimum Parts)

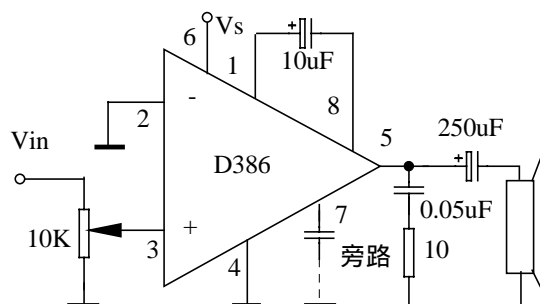

Fig2 Amplifier with Gain = 200

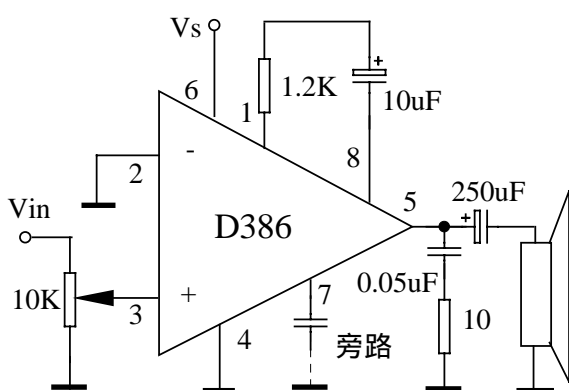

Fig3 Amplifier with Gain = 50

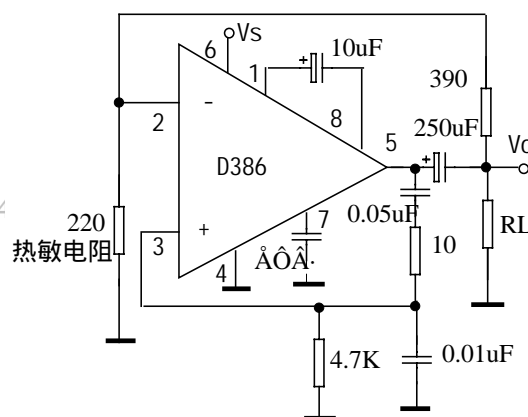

Fig4 Low Distortion Power  
Wienbridge Oscillator

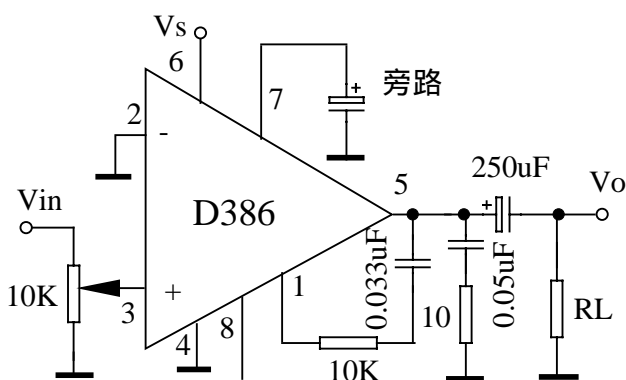

Fig5 Amplifier with Bass Boost

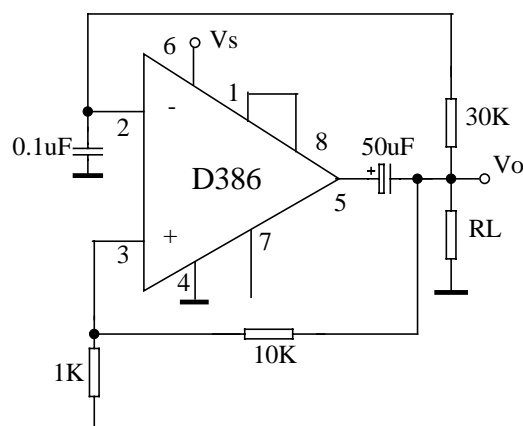

Fig6 Square Wave Oscillator

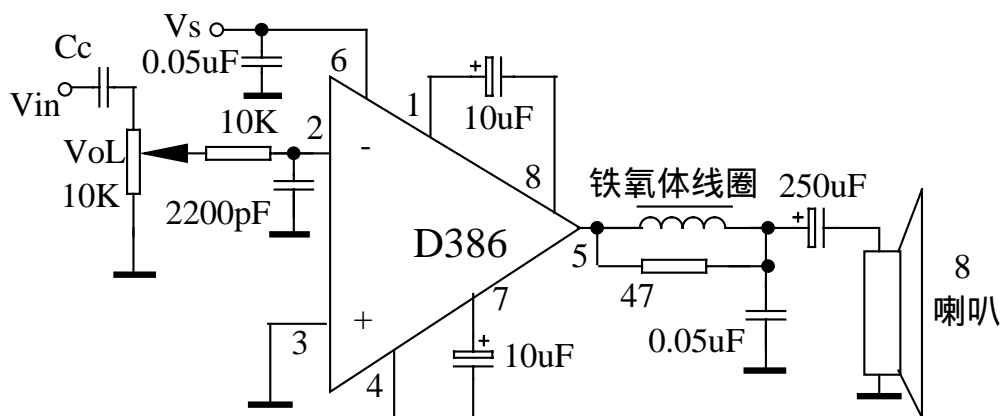
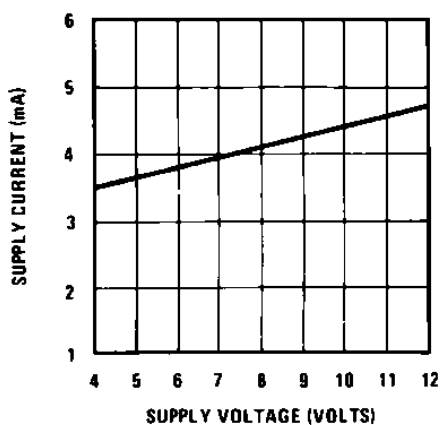

Fig7 AM Radio Power Amplifier

## TYPICAL PERFORMANCE CHARACTERISTICS

Quiescent Supply Current vs Supply Voltage



Power Supply Rejection Ratio (Referred to the Output) vs Frequency

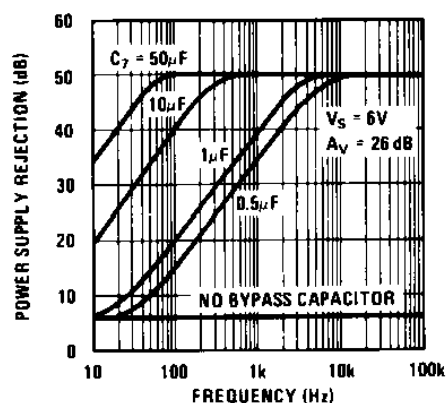

Peak-to-Peak Output Voltage Swing vs Supply Voltage

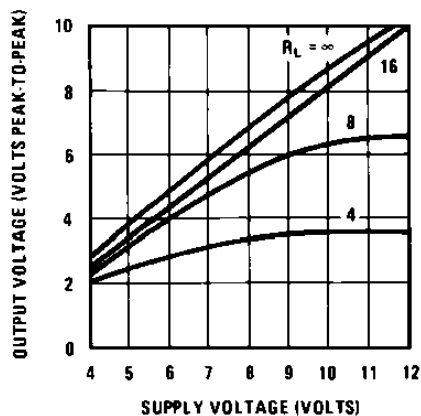

Voltage Gain vs Frequency

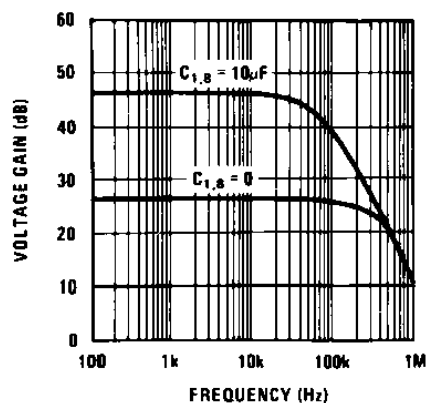

### Distortion vs Frequency

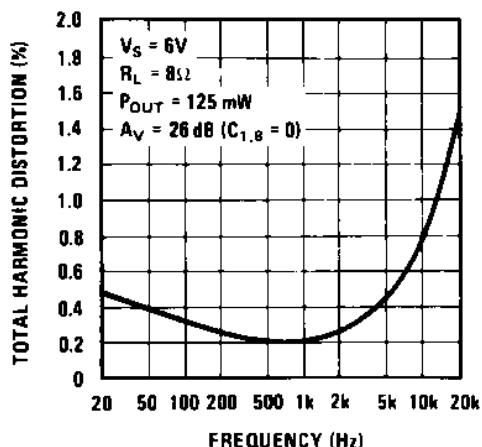

### Distortion vs Output Power

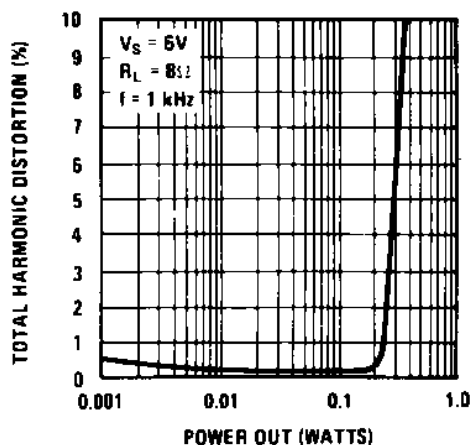

### Device Dissipation vs Output Power—4Ω Load

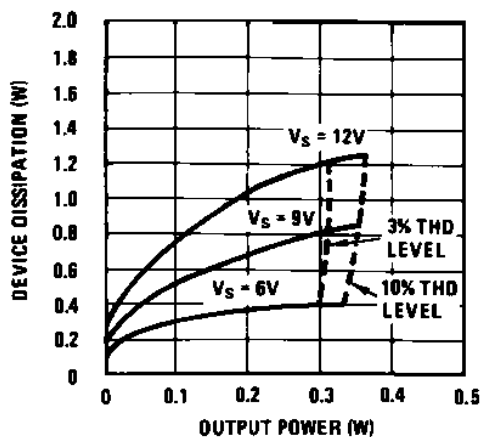

### Device Dissipation vs Output Power—8Ω Load

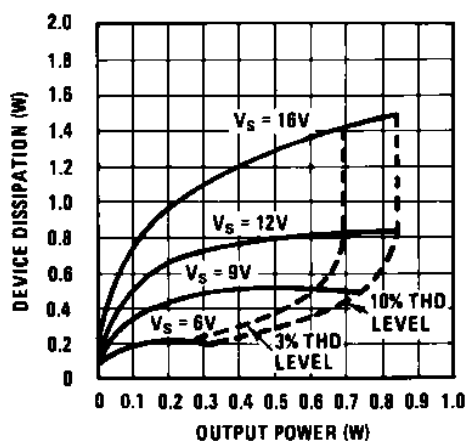

### Device Dissipation vs Output Power—16Ω Load

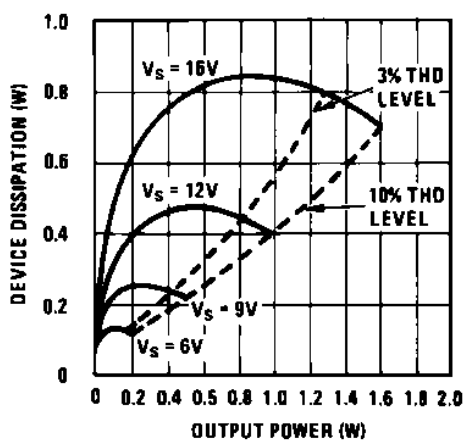

### Frequency Response with Bass Boost

