

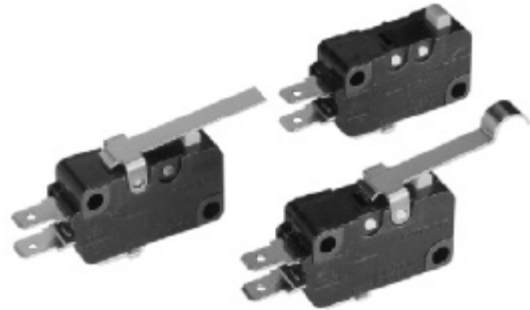







Reliable and Safe Snap Action Switch with External Lever

- Environment-friendly - free of beryllium copper
- Maximum operating temperature of 105°C
- Self-cleaning contacts
- Available in 6-A, 11-A or 16-A models
- Available with internally or externally fitted levers
- Two operate positions for external levers
- Conforms to EN61058-1









Ordering Information

■ 16 A (OF: 200 GF)

Item		Part number		
Actuator	Lever position	Contact form		
		SPDT	SPST-NC	SPST-NO
Pin plunger 	---	D3V-16G-1□5Δ	D3V-16G-2□5Δ	D3V-16G-3□5Δ
Short hinge lever 	Internal	D3V-16G1-1□5Δ	D3V-16G1-2□5Δ	D3V-16G1-3□5Δ
	External	D3V-16G1M-1□5Δ	D3V-16G1M-2□5Δ	D3V-16G1M-3□5Δ
Hinge lever 	Internal	D3V-16G2-1□5Δ	D3V-16G2-2□5Δ	D3V-16G2-3□5Δ
	External	D3V-16G2M-1□5Δ	D3V-16G2M-2□5Δ	D3V-16G2M-3□5Δ
Long hinge lever 	Internal	D3V-16G3-1□5Δ	D3V-16G3-2□5Δ	D3V-16G3-3□5Δ
	External	D3V-16G3M-1□5Δ	D3V-16G3M-2□5Δ	D3V-16G3M-3□5Δ
Simulated roller lever 	Internal	D3V-16G4-1□5Δ	D3V-16G4-2□5Δ	D3V-16G4-3□5Δ
	External	D3V-16G4M-1□5Δ	D3V-16G4M-2□5Δ	D3V-16G4M-3□5Δ
Short hinge roller lever 	Internal	D3V-16G5-1□5Δ	D3V-16G5-2□5Δ	D3V-16G5-3□5Δ
	External	D3V-16G5M-1□5Δ	D3V-16G5M-2□5Δ	D3V-16G5M-3□5Δ
Hinge roller lever 	Internal	D3V-16G6-1□5Δ	D3V-16G6-2□5Δ	D3V-16G6-3□5Δ
	External	D3V-16G6M-1□5Δ	D3V-16G6M-2□5Δ	D3V-16G6M-3□5Δ

■ 11 A (OF: 200 GF)

Item		Part number		
Actuator	Lever position	Contact form		
		SPDT	SPST-NC	SPST-NO
Pin plunger 	---	D3V-11G-1□5Δ	D3V-11G-2□5Δ	D3V-11G-3□5Δ
Short hinge lever 	Internal	D3V-11G1-1□5Δ	D3V-11G1-2□5Δ	D3V-11G1-3□5Δ
	External	D3V-11G1M-1□5Δ	D3V-11G1M-2□5Δ	D3V-11G1M-3□5Δ
Hinge lever 	Internal	D3V-11G2-1□5Δ	D3V-11G2-2□5Δ	D3V-11G2-3□5Δ
	External	D3V-11G2M-1j5Δ	D3V-11G2M-2□5Δ	D3V-11G2M-3□5Δ
Long hinge lever 	Internal	D3V-11G3-1□5Δ	D3V-11G3-2□5Δ	D3V-11G3-3□5Δ
	External	D3V-11G3M-1□5Δ	D3V-11G3M-2□5Δ	D3V-11G3M-3□5Δ
Simulated roller lever 	Internal	D3V-11G4-1□5Δ	D3V-11G4-2□5Δ	D3V-11G4-3□5Δ
	External	D3V-11G4M-1□5Δ	D3V-11G4M-2□5Δ	D3V-11G4M-3□5Δ
Short hinge roller lever 	Internal	D3V-11G5-1□5Δ	D3V-11G5-2□5Δ	D3V-11G5-3□5Δ
	External	D3V-11G5M-1□5Δ	D3V-11G5M-2□5Δ	D3V-11G5M-3□5Δ
Hinge roller lever 	Internal	D3V-11G6-1□5Δ	D3V-11G6-2□5Δ	D3V-11G6-3□5Δ
	External	D3V-11G6M-1□5Δ	D3V-11G6M-2□5Δ	D3V-11G6M-3□5Δ

Note: The □ in the model number is for the terminal code.

A: Solder/quick-connect terminals (#187)

C2: Quick-connect terminals (#187)







C: Quick-connect terminals (#250)

The Δ in the model number is for the mounting hole size.

None: 3.1 mm

K: 2.9 mm

■ 11 A (OF: 100 GF)

Item		Part number			
Actuator	Lever position	Contact form			
		SPDT	SPST-NC	SPST-NO	
Pin plunger 	---	D3V-11G-1□4Δ	D3V-11G-2□4Δ	D3V-11G-3□4Δ	
Short hinge lever 	Internal	D3V-11G1-1□4Δ	D3V-11G1-2□4Δ	D3V-11G1-3□4Δ	
	External	D3V-11G1M-1□4Δ	D3V-11G1M-2□4Δ	D3V-11G1M-3□4Δ	
Hinge lever 	Internal	D3V-11G2-1□4Δ	D3V-11G2-2□4Δ	D3V-11G2-3□4Δ	
	External	D3V-11G2M-1□4Δ	D3V-11G2M-2□4Δ	D3V-11G2M-3□4Δ	
Long hinge lever 	Internal	D3V-11G3-1□4Δ	D3V-11G3-2□4Δ	D3V-11G3-3□4Δ	
	External	D3V-11G3M-1□4Δ	D3V-11G3M-2□4Δ	D3V-11G3M-3□4Δ	
Simulated roller lever 	Internal	D3V-11G4-1□4Δ	D3V-11G4-2□4Δ	D3V-11G4-3□4Δ	
	External	D3V-11G4M-1□4Δ	D3V-11G4M-2□4Δ	D3V-11G4M-3□4Δ	
Short hinge roller lever 	Internal	D3V-11G5-1□4Δ	D3V-11G5-2□4Δ	D3V-11G5-3□4Δ	
	External	D3V-11G5M-1□4Δ	D3V-11G5M-2□4Δ	D3V-11G5M-3□4Δ	
Hinge roller lever 	Internal	D3V-11G6-1□4Δ	D3V-11G6-2□4Δ	D3V-11G6-3□4Δ	
	External	D3V-11G6M-1□4Δ	D3V-11G6M-2□4Δ	D3V-11G6M-3□4Δ	

Note: The □ in the model number is for the terminal code.

A: Solder/quick-connect terminals (#187)

C2: Quick-connect terminals (#187)







C: Quick-connect terminals (#250)

The Δ in the model number is for the mounting hole size.

None: 3.1 mm

K: 2.9 mm

■ 6 A (OF: 100 GF)

Item		Part number		
Actuator	Lever position	Contact form		
		SPDT	SPST-NC	SPST-NO
Pin plunger 	---	D3V-6G-1□4Δ	D3V-6G-2□4Δ	D3V-6G-3□4Δ
Short hinge lever 	Internal	D3V-6G1-1□4Δ	D3V-6G1-2□4Δ	D3V-6G1-3□4Δ
	External	D3V-6G1M-1□4Δ	D3V-6G1M-2□4Δ	D3V-6G1M-3□4Δ
Hinge lever 	Internal	D3V-6G2-1□4Δ	D3V-6G2-2□4Δ	D3V-6G2-3□4Δ
	External	D3V-6G2M-1□4Δ	D3V-6G2M-2□4Δ	D3V-6G2M-3□4Δ
Long hinge lever 	Internal	D3V-6G3-1□4Δ	D3V-6G3-2□4Δ	D3V-6G3-3□4Δ
	External	D3V-6G3M-1□4Δ	D3V-6G3M-2□4Δ	D3V-6G3M-3□4Δ
Simulated roller lever 	Internal	D3V-6G4-1□4Δ	D3V-6G4-2□4Δ	D3V-6G4-3□4Δ
	External	D3V-6G4M-1□4Δ	D3V-6G4M-2□4Δ	D3V-6G4M-3□4Δ
Short hinge roller lever 	Internal	D3V-6G5-1□4Δ	D3V-6G5-2□4Δ	D3V-6G5-3□4Δ
	External	D3V-6G5M-1□4Δ	D3V-6G5M-2□4Δ	D3V-6G5M-3□4Δ
Hinge roller lever 	Internal	D3V-6G6-1□4Δ	D3V-6G6-2□4Δ	D3V-6G6-3□4Δ
	External	D3V-6G6M-1□4Δ	D3V-6G6M-2□4Δ	D3V-6G6M-3□4Δ

Note: The □ in the model number is for the terminal code.

A: Solder/quick-connect terminals (#187)

C2: Quick-connect terminals (#187)

C: Quick-connect terminals (#250)

The Δ in the model number is for the mounting hole size.

None: 3.1 mm

K: 2.9 mm

Specifications

■ CHARACTERISTICS

Operating speed		0.1 mm to 1 m/s (at pin plunger models)
Operating frequency	Mechanical	600 operations/min
	Electrical	60 operations/min
Insulation resistance		100 M Ω min. (at 500 VDC)
Contact resistance		15 m Ω max. (initial value)
Dielectric strength		1,000 VAC, 50/60 Hz for 1 min between terminals of the same polarity
		2,000 VAC, 50/60 Hz for 1 min between current-carrying metal parts and ground, and between each terminal and non-current-carrying metal parts (See Note 1.)
Vibration resistance (See Note 2.)	Malfunction	10 to 55 Hz, 1.5-mm double amplitude
Shock resistance (see note 2)	Destruction	1,000 m/s ² approx. 100G max.
	Malfunction	300 m/s ² approx. 30G max.
Life expectancy (See Note 3.)	Mechanical	10,000,000 operations min.
	Electrical	D3V-16: 100,000 operations min. D3V-11: 200,000 operations min. D3V-6: 500,000 operations min.
Degree of protection		IP00
Degree of protection against electric shock		Class I
Proof tracking index (PTI)		250
Switch category		D (IEC335-1)
Ambient temperature	Operating	-25°C to 105°C (-13°F to 221°F) with no icing
Ambient humidity	Operating	85% max. for 5°C to 35°C (41°F to 95°F)
Weight		Approx. 6.2 g (pin plunger model)

- Note: 1. The dielectric strength values shown in the table are for models with a Separator.
 2. For the pin plunger models, the above values apply for use at both the free position and total travel position. For the lever models, they apply at the total travel position.
 3. For testing conditions, contact your OMRON sales representative.

■ OPERATING CHARACTERISTICS

Characteristics	Part number					
	D3V-16G-1□5Δ D3V-11G-1□5Δ	D3V-11G-1□4Δ D3V-6G-1□4Δ	D3V-16G1M-1□5Δ D3V-11G1M-1□5Δ	D3V-11G1M-1□4Δ D3V-6G1M-1□4Δ	D3V-16G2M-1□5Δ D3V-11G2M-1□5Δ	D3V-11G2M-1□4Δ D3V-6G2M-1□4Δ
OF max.	200 gf	100 gf	200 gf	100 gf	125 gf	60 gf
RF min.	50 gf	15 gf	50 gf	15 gf	14 gf	6 gf
PT max.	1.2 mm		1.6 mm		4.0 mm	
OT min.	1.0 mm		0.8 mm		1.6 mm	
MD max.	0.4 mm		0.6 mm		1.5 mm	
OP	14.7±0.4 mm		15.2±0.5 mm		15.2±1.2 mm	

Characteristics	Part number				
	D3V-16G3M-1□5Δ D3V-11G3M-1□5Δ	D3V-11G3M-1□4Δ D3V-6G3M-1□4Δ	D3V-16G4M-1□5Δ D3V-11G4M-1□5Δ	D3V-11G4M-1□4Δ D3V-6G4M-1□4Δ	D3V-16G5M-□5Δ D3V-11G5M-1□5Δ
OF max.	70 gf	35 gf	125 g	60 gf	240 gf
RF min.	6 gf	---	14 gf	6 gf	50 gf
PT max.	9.0 mm		4.0 mm		1.6 mm
OT min.	2.0 mm		1.6 mm		0.8 mm
MD max.	2.8 mm		1.5 mm		0.6 mm
OP	15.2 ^{+2.6} _{-3.2} mm		18.7±1.2 mm		20.7±0.6 mm

Characteristics	Part number		
	D3V-11G5M-1□4Δ D3V-6G5M-1□4Δ	D3V-16G6M-1□5Δ D3V-11G6M-1□5Δ	D3V-11G6M-1□4Δ D3V-6G6M-1□4Δ
OF max.	120 gf	125 gf	60 gf
RF min.	15 gf	14 gf	6 gf
PT max.	1.6 mm	4.0 mm	
OT min.	0.8 mm	1.6 mm	
MD max.	0.6 mm	1.5 mm	
OP	20.7±0.6 mm	20.7±1.2 mm	

■ RATINGS

Type	Rated voltage	Non-inductive load				Inductive load			
		Resistive load		Lamp load		Inductive load		Motor load	
		NC	NO	NC	NO	NC	NO	NC	NO
D3V-16G	250 VAC	16 A		2 A		10 A		3 A	
	8 VDC	16 A		4 A		10 A		6 A	
	30 VDC	10 A		4 A		10 A		4 A	
	125 VDC	0.6 A		0.1 A		0.6 A		0.1 A	
	250 VDC	0.3 A		0.05 A		0.3 A		0.05 A	
D3V-11G	250 VAC	11 A		1.5 A		6 A		2 A	
	8 VDC	11 A		3 A		6 A		3 A	
	30 VDC	6 A		3 A		6 A		3 A	
	125 VDC	0.6 A		0.1 A		0.6 A		0.1 A	
	250 VDC	0.3 A		0.05 A		0.3 A		0.05 A	
D3V-6G	250 VAC	6 A		3 A		4 A		---	
	8 VDC	6 A		3 A		4 A		---	
	30 VDC	6 A		3 A		4 A		---	
	125 VDC	0.4 A		0.1 A		0.4 A		---	
	250 VDC	0.3 A		0.05 A		0.2 A		---	

- Note: 1. Above current values are normal for models with a contact gap of 0.5mm and models with a contact gap of 1mm.
 2. Inductive load has a power factor of 0.4 min. (AC) and a time constant of 7 ms max. (DC).
 3. Lamp load has an inrush current of 10 times the steady-state current.
 4. Motor load has an inrush current of 6 times the steady-state current.
 5. The ratings values apply under the following test conditions:
 Ambient temperature: 20±2°C
 Ambient humidity: 65±5%
 Operating frequency: 60 operations/min

■ CONTACT FORM

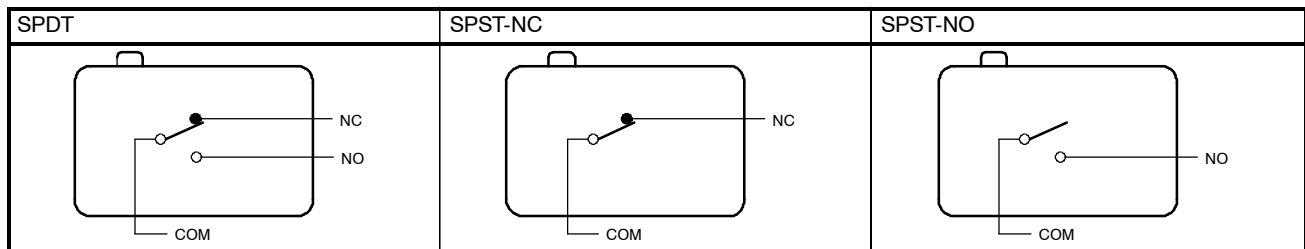

■ APPROVED STANDARDS

UL1054 (File No. E41515) CSA C22.2 No.55 (File No. LR21642)
 (Standard Ratings Only is listed.)

Rated voltage	D3V-16	D3V-16G	D3V-11	D3V-11G	D3V-6
125 VAC	16 A, 1/2 HP	16 A, 1/2 HP	11 A, 1/2 HP	11 A, 1/2 HP	6 A, 1/4 HP
250 VAC	16 A, 1/2 HP	16 A, 1/2 HP	11 A, 1/2 HP	11 A, 1/2 HP	6 A, 1/4 HP
125 VDC	0.6 A	0.1 A	0.6 A	0.1 A	---
250 VDC	0.3 A	---	0.3 A	---	---

■ EN 61058-1: 1992+A1: 1993 (LICENSE NO. 119151L)

Rated voltage	D3V-16	D3V-11	D3V-6
250 VAC	16 (3) A	11 (3) A	6 (2) A

Testing conditions: 50,000 operations, T105 (0°C to 105°C)

Dimensions

Unit: mm (inch)

■ TERMINALS

Terminal type	Solder/Quick-connect Terminal (#187) (A)	Quick-connect Terminal (#187) (C2)	Quick-connect Terminal (#250) (C)
COM	<p>t = 0.5 Three, solder/quick-connect terminals (#187)</p>	<p>t = 0.5 Three, quick-connect terminals (#187)</p>	<p>t = 0.8 Three, quick-connect terminals (#250)</p>
Terminal dimensions	<p>Note: Indicates the length to the center of the 1.6-dia. holes</p>	<p>1.6-dia. terminal hole</p>	<p>1.65-dia. terminal hole</p>

Note: The above is for the SPDT contact specifications. Two terminals will be available for SPST-NO or SPST-NC contact specifications. For terminal positions, refer to the above *Contact Form*.

■ DIMENSIONS AND OPERATING CHARACTERISTICS

- Unless otherwise specified, a tolerance of ±0.4 mm applies to all dimensions.
- The following illustrations and drawings are for quick-connect terminals (#250) (terminals C). D3V models incorporate terminals A and C2. These models are different from #250 models in terminal size only. Terminals A and C2 are omitted from the following drawings. Refer to *Terminals* (above).
- The following illustrations and drawings are for models with the hinge position set to external/further than plunger. Models with the hinge position set to internal position are not shown here. For details about the internal position models, contact your OMRON sales representative. Operating characteristics are the same for these two types of models.
- The □ in the model number is for the terminal code.
- The Δ in the model number is for the mounting hole size. The hole size in the following illustrations of models with a suffix “K” in the Δ is 2.9 mm.

■ PIN PLUNGER

- D3V-16G-1□5Δ
- D3V-11G-1□5Δ
- D3V-11G-1□4Δ
- D3V-6G-1□4Δ

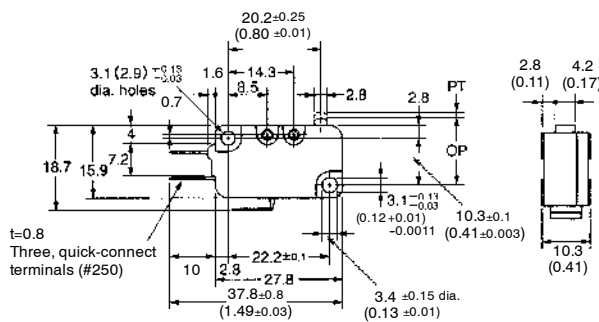
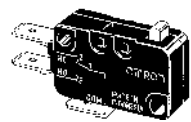

Unit: mm (inch)

■ SHORT HINGE LEVER

- D3V-16G1M-1□5△
- D3V-11G1M-1□5△
- D3V-11G1M-1□4△
- D3V-6G1M-1□4△

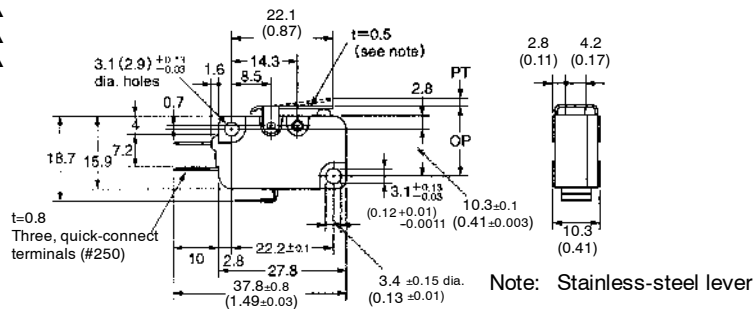

■ HINGE LEVER

- D3V-16G2M-1□5△
- D3V-11G2M-1□5△
- D3V-11G2M-1□4△
- D3V-6G2M-1□4△

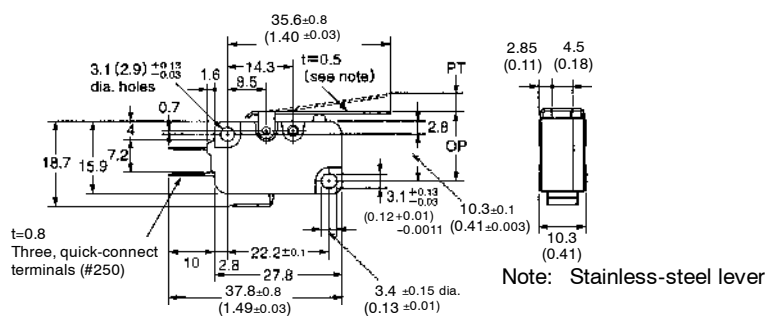
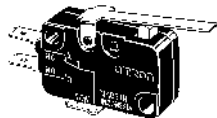

■ LONG HINGE LEVER

- D3V-16G3M-1□5△
- D3V-11G3M-1□5△
- D3V-11G3M-1□4△
- D3V-6G3M-1□4△

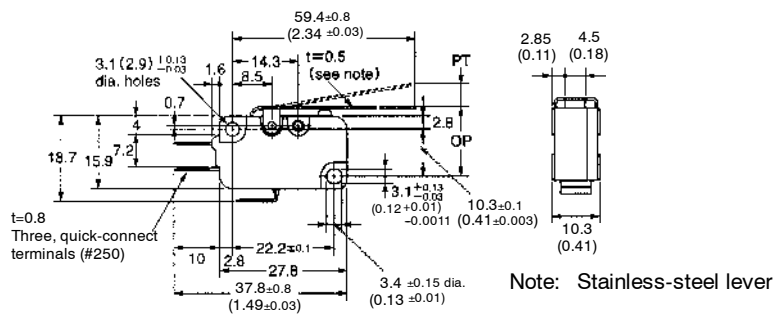
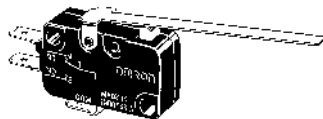

■ SIMULATED ROLLER LEVER

- D3V-16G4M-1□5△
- D3V-11G4M-1□5△
- D3V-11G4M-1□4△
- D3V-6G4M-1□4△

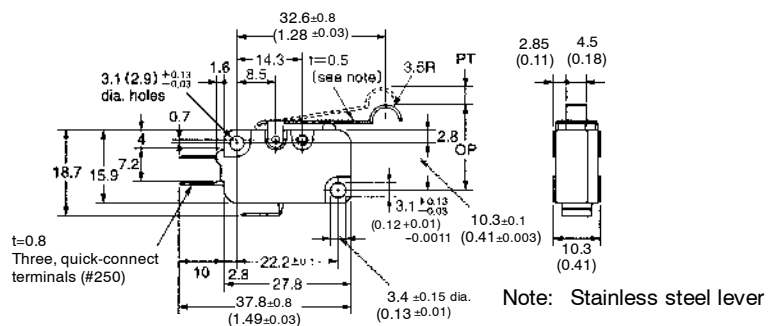
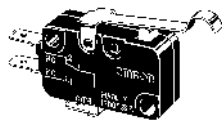

■ SHORT HINGE ROLLER LEVER

- D3V-16G5M-1 □5△
- D3V-11G5M-1 □5△
- D3V-11G5M-1 □4△
- D3V-6G5M-1 □4△

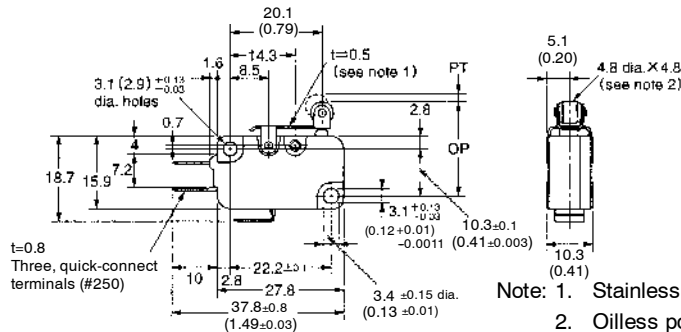
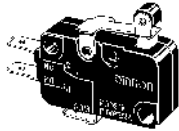

- Note: 1. Stainless-steel lever
2. Oilless polyacetal resin roller

www.DataSheet4U.com

■ HINGE ROLLER LEVER

- D3V-16G6M-1 □5△
- D3V-11G6M-1 □5△
- D3V-11G6M-1 □4△
- D3V-6G6M-1 □4△

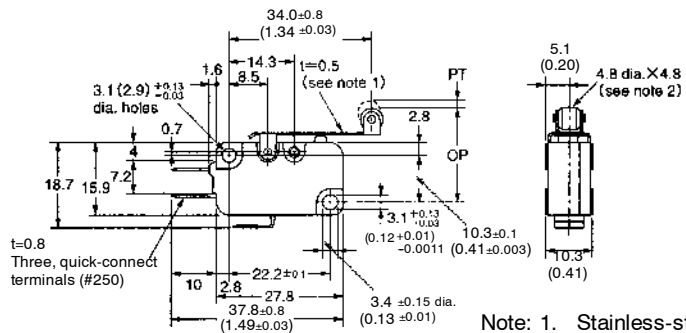
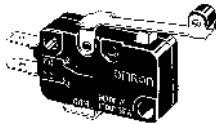

- Note: 1. Stainless-steel lever
2. Oilless polyacetal resin roller

Precautions

■ MOUNTING DIMENSIONS

Use two M3 mounting screws with an appropriate screwdriver to mount the switch. Tighten the screws to a torque of 0.39 to 0.59 N • m {4 to 6 kgf • cm}.

Mounting Holes

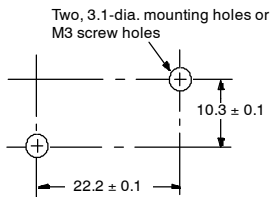

NOTE: DIMENSIONS SHOWN ARE IN MILLIMETERS. To convert millimeters to inches divide by 25.4.

OMRON[®]
OMRON ELECTRONICS LLC
One East Commerce Drive
Schaumburg, IL 60173
1-800-55-OMRON

OMRON ON-LINE
Global - <http://www.omron.com>
USA - <http://www.omron.com/oei>
Canada - <http://www.omron.com/oci>

OMRON CANADA, INC.
885 Milner Avenue
Scarborough, Ontario M1B 5V8
416-286-6465