

Bridge Rectifiers

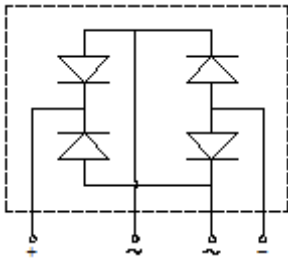
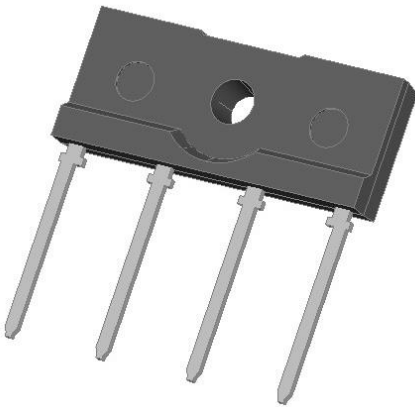

Features

- UL recognition, file #E230084
- Thin single in-line package
- High surge current capability
- Solder dip 275 °C max. 7 s, per JESD 22-B106

Typical Applications

General purpose use in AC/DC bridge full wave rectification for switching power supply, home appliances, office equipment, industrial automation applications.

Mechanical Data

- **Package:** JB
Molding compound meets UL 94 V-0 flammability rating, RoHS-compliant
- **Terminals:** Tin plated leads, solderable per J-STD-002 and JESD22-B102
- **Polarity:** As marked on body

■ Maximum Ratings (T_a=25°C Unless otherwise specified)

| PARAMETER | SYMBOL | UNIT | D4JB05 | D4JB10 | D4JB20 | D4JB40 | D4JB60 | D4JB80 | D4JB100 |
|--|--|------------------|-----------|--------|--------|--------|--------|--------|---------|
| Device marking code | | | D4JB05 | D4JB10 | D4JB20 | D4JB40 | D4JB60 | D4JB80 | D4JB100 |
| Repetitive Peak Reverse Voltage | VRRM | V | 50 | 100 | 200 | 400 | 600 | 800 | 1000 |
| Average Rectified Output Current @60Hz sine wave, R-load, | With heatsink T _c =100°C | I _O | A | 4.0 | | | | | |
| | Without heatsink T _a =25°C | | | 2.3 | | | | | |
| Surge(non-repetitive)forward current @60Hz half-sine wave, 1 cycle, T _j =25°C | IFSM | A | 135 | | | | | | |
| Current squared time @1ms≤t≤8.3ms T _j =25°C, rating of per diode | I ² t | A ² S | 76 | | | | | | |
| Storage Temperature | T _{stg} | °C | -55 ~+150 | | | | | | |
| Junction Temperature | T _j | °C | -55 ~+150 | | | | | | |
| Dielectric strength @ terminals to case, AC 1 minute | V _{dis} | KV | 2 | | | | | | |
| Mounting torque @recommend torque: 5kg · cm | Tor | kg · cm | 8 | | | | | | |

■ Electrical Characteristics (T_a=25°C Unless otherwise specified)

| PARAMETER | SYMBOL | UNIT | TEST CONDITIONS | D4JB05 | D4JB10 | D4JB20 | D4JB40 | D4JB60 | D4JB80 | D4JB100 |
|---|------------------|------|-----------------------------------|--------|--------|--------|--------|--------|--------|---------|
| Maximum instantaneous forward voltage drop per diode | V _F | V | I _{FM} =2.0A | 1.00 | | | | | | |
| Maximum DC reverse current at rated DC blocking voltage per diode | I _{RRM} | μA | V _{RM} =V _{RRM} | 5 | | | | | | |



D4JB05 THRU D4JB100

■ Thermal Characteristics (T_a=25°C Unless otherwise specified)

| PARAMETER | | SYMBOL | UNIT | D4JB05 | D4JB10 | D4JB20 | D4JB40 | D4JB60 | D4JB80 | D4JB100 |
|--------------------|--|-------------------|------|--------|--------|--------|--------|--------|--------|---------|
| Thermal Resistance | Between junction and ambient, Without heatsink | R _{θJ-A} | °C/W | 35.0 | | | | | | |
| | Between junction and case, With heatsink | R _{θJ-C} | | 5.8 | | | | | | |

■ Ordering Information (Example)

| PREFERRED P/N | PACKAGE CODE | UNIT WEIGHT(g) | MINIMUM PACKAGE(pcs) | INNER BOX QUANTITY(pcs) | OUTER CARTON QUANTITY(pcs) | DELIVERY MODE |
|----------------|--------------|-----------------|----------------------|-------------------------|----------------------------|---------------|
| D4JB05~D4JB100 | B1 | Approximate 2.4 | 20 | 1000 | 2000 | Tube |

■ Characteristics(Typical)

FIG1:I_o-T_c Curve

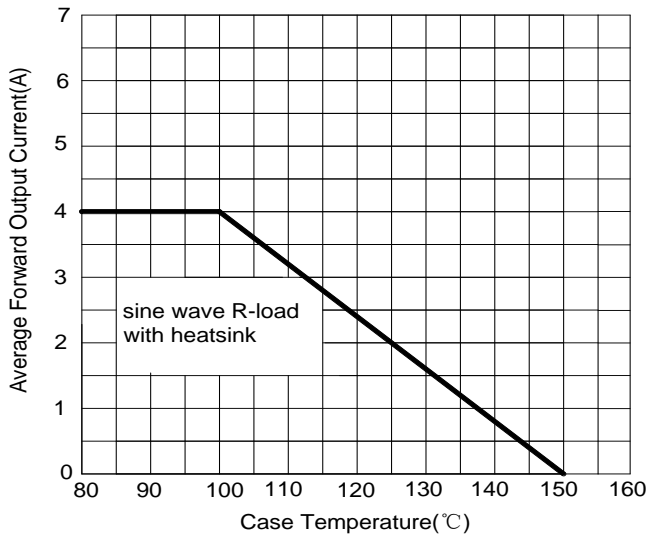

FIG2:Surge Forward Current Capability

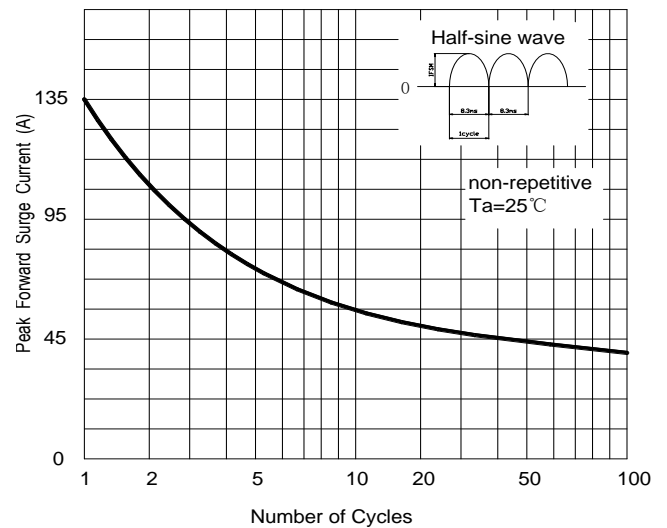

FIG3:Instantaneous Forward Voltage

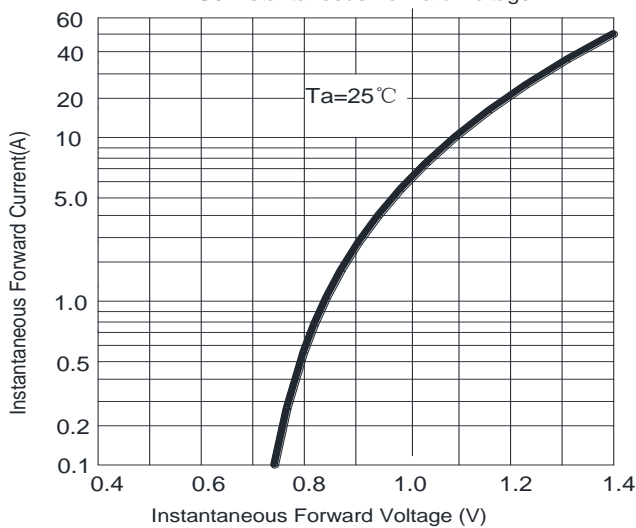
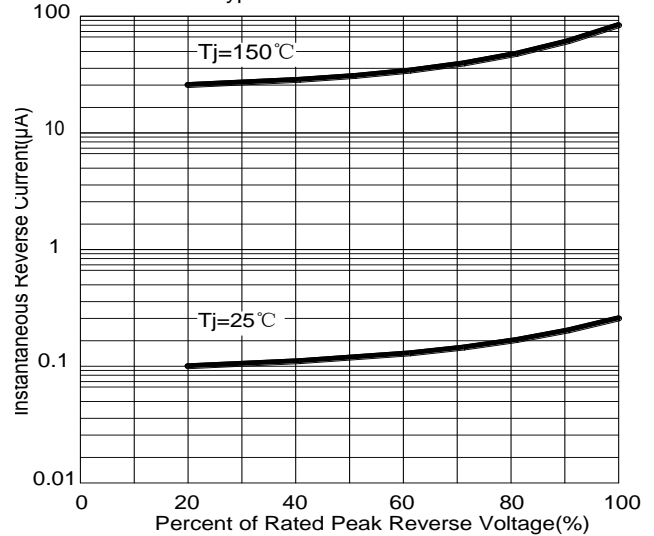

FIG4:Typical Reverse Characteristics





D4JB05 THRU D4JB100

■ Outline Dimensions

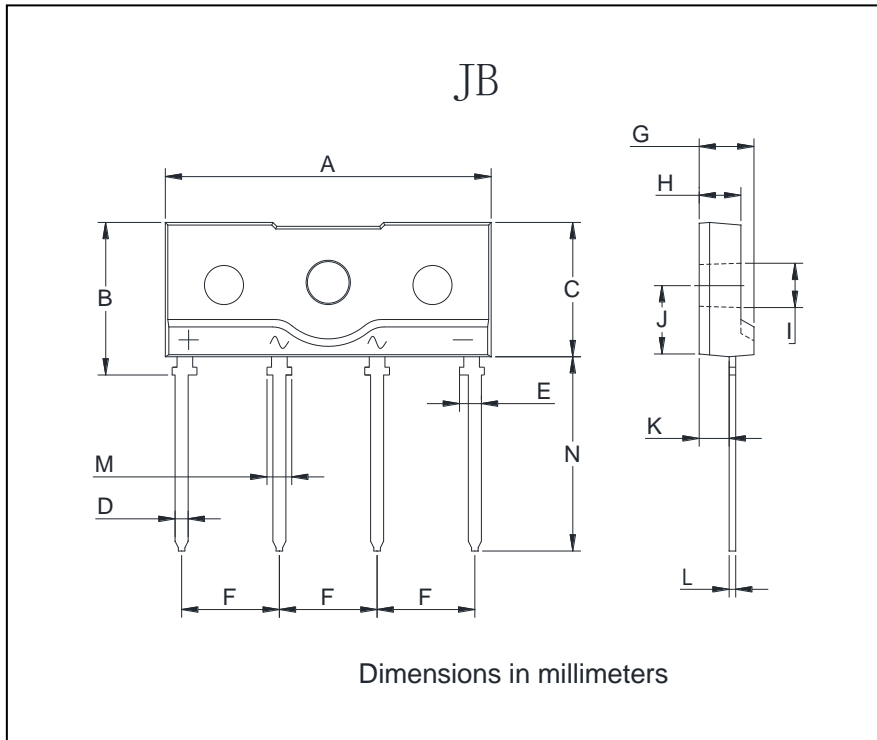

| JB | | |
|-----|-----------|------|
| Dim | Min | Max |
| A | 24.7 | 25.3 |
| B | 11.4 | 12.0 |
| C | 10.0 | 10.6 |
| D | 0.9 | 1.1 |
| E | 1.75(MAX) | |
| F | 7.3 | 7.7 |
| G | 3.9 | 4.5 |
| H | 2.9 | 3.9 |
| I | 3.1 | 3.4 |
| J | 5.4 | 6.0 |
| K | 2.0 | 2.6 |
| L | 0.4 | 0.6 |
| M | 2.1 | 2.3 |
| N | 14.6 | 15.2 |



Disclaimer

The information presented in this document is for reference only. Yangzhou Yangjie Electronic Technology Co., Ltd. reserves the right to make changes without notice for the specification of the products displayed herein to improve reliability, function or design or otherwise.

The product listed herein is designed to be used with ordinary electronic equipment or devices, and not designed to be used with equipment or devices which require high level of reliability and the malfunction of which would directly endanger human life (such as medical instruments, transportation equipment, aerospace machinery, nuclear-reactor controllers, fuel controllers and other safety devices), Yangjie or anyone on its behalf, assumes no responsibility or liability for any damages resulting from such improper use of sale.

This publication supersedes & replaces all information previously supplied. For additional information, please visit our website [http:// www.21yangjie.com](http://www.21yangjie.com) , or consult your nearest Yangjie's sales office for further assistance.