

Feature & Dimension

- . Plastic Package has Underwriters Laboratory Flammability Classification 94V-0
- . This series is UL listed under the Recognized Component index, file number E231047
- . Single-in-line package
- . High current capacity with small package
- . Superior thermal conductivity
- . High temperature soldering guaranteed:
260 /10 seconds
- . High I_{FSM}

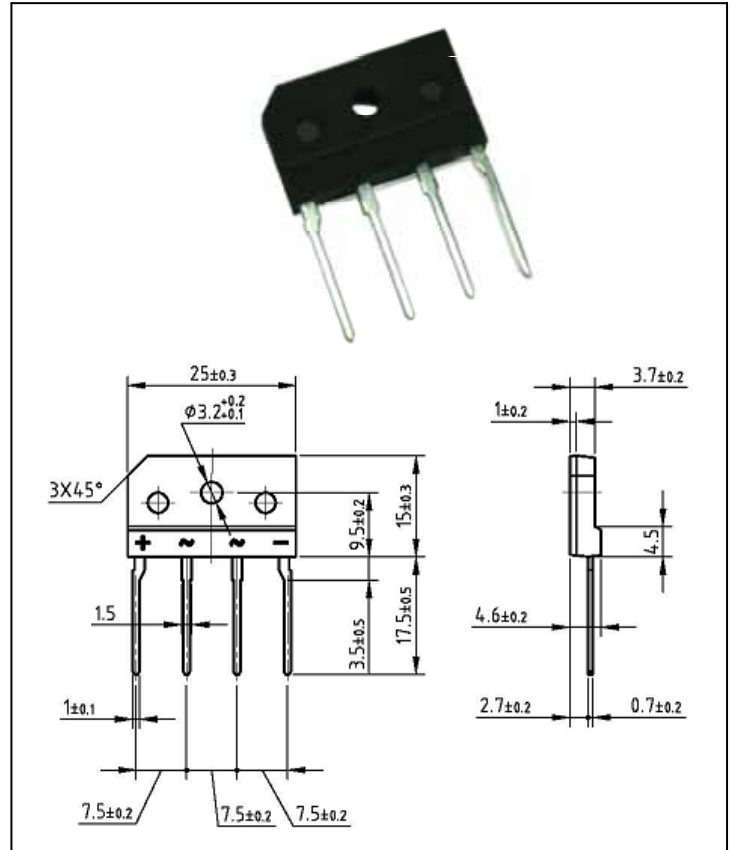

Product Characteristic

Parameter Symbol	Symbol	D4SB10	D4SB20	D4SB40	D4SB60	D4SB80	D4SB100	Unit
		RBV602S	RBV603S	RBV604S	RBV605S	RBV606S	RBV607S	
Maximum repetitive voltage	V_{RM}	100	200	400	600	800	1000	V
Maximum DC reverse current at rated DC blocking voltage	I_R	10						μA
$T_A=25$ $T_A=125$		500						
Average rectified forward current 60Hz Sine wave Resistance load	I_o	6 ⁽¹⁾						A
$T_C=100$ $T_A=25$		2.8 ⁽²⁾						
Peak forward surge current 10ms single half sine-wave superimposed on rated load	I_{FSM}	150						A
Dielectric strength terminals to case , AC 1 minute Current 1mA	V_{dia}	2.5						KV
Max instantaneous forward voltage at 3.0A	V_F	1.1						V
Operating junction temperature	T_J	150						
Maximum thermal resistance per leg on P.C.B. without heat-sink on Al plate heat-sink	$R_{\theta JA}$	22 ⁽²⁾						/W
	$R_{\theta JC}$	3.4 ⁽¹⁾						
Storage temperature	T_{stg}	-40~150						

- Notes :**
- (1) Unit case mounted on Al plate heat-sink
 - (2) Unites mounted on P.C.B. without heat-sink
 - (3) Recommended mounting position is to bolt down on heatsink with silicone thermal compound for maximum heat transfer with #6 screw {heat-sink size: 6.5*4.0*0.3cm}

Characteristic Curves

Fig. 1 Derating Curve

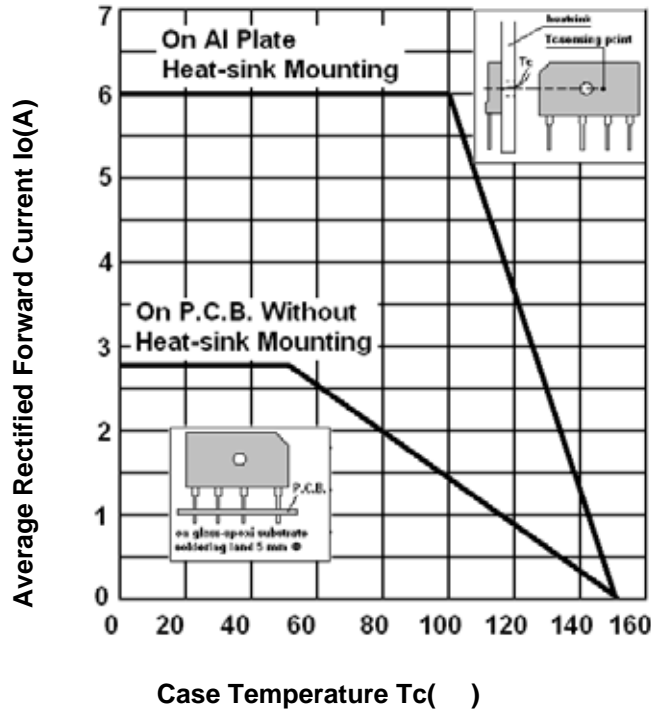

Fig.2 Typical Reverse Characteristics

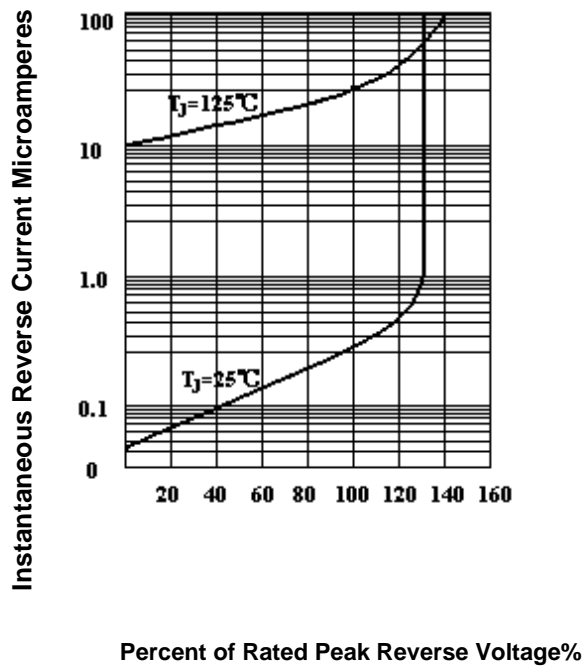

Fig.3 Peak Surge Forward capability

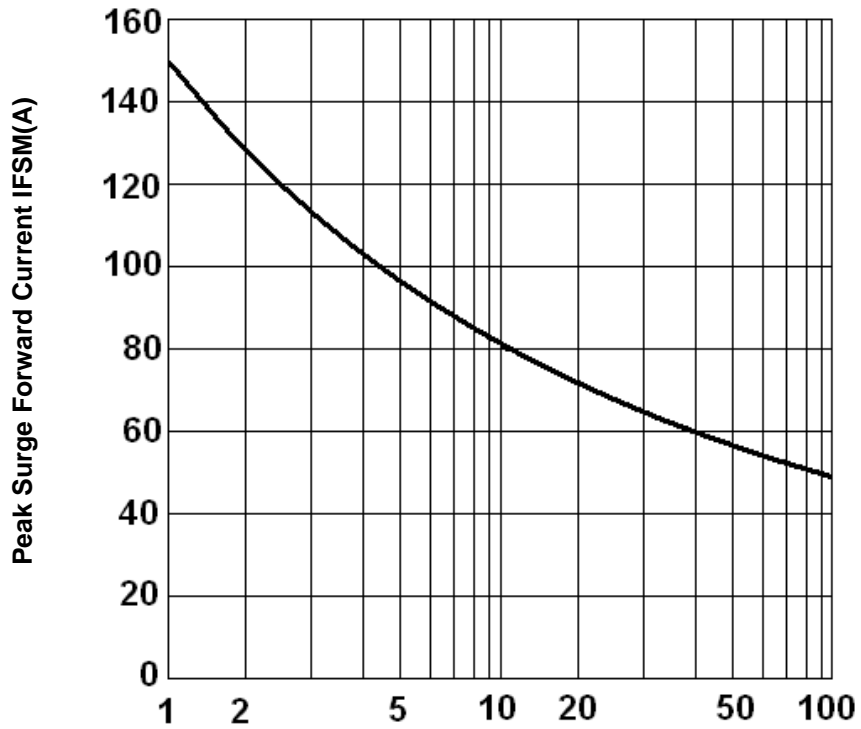
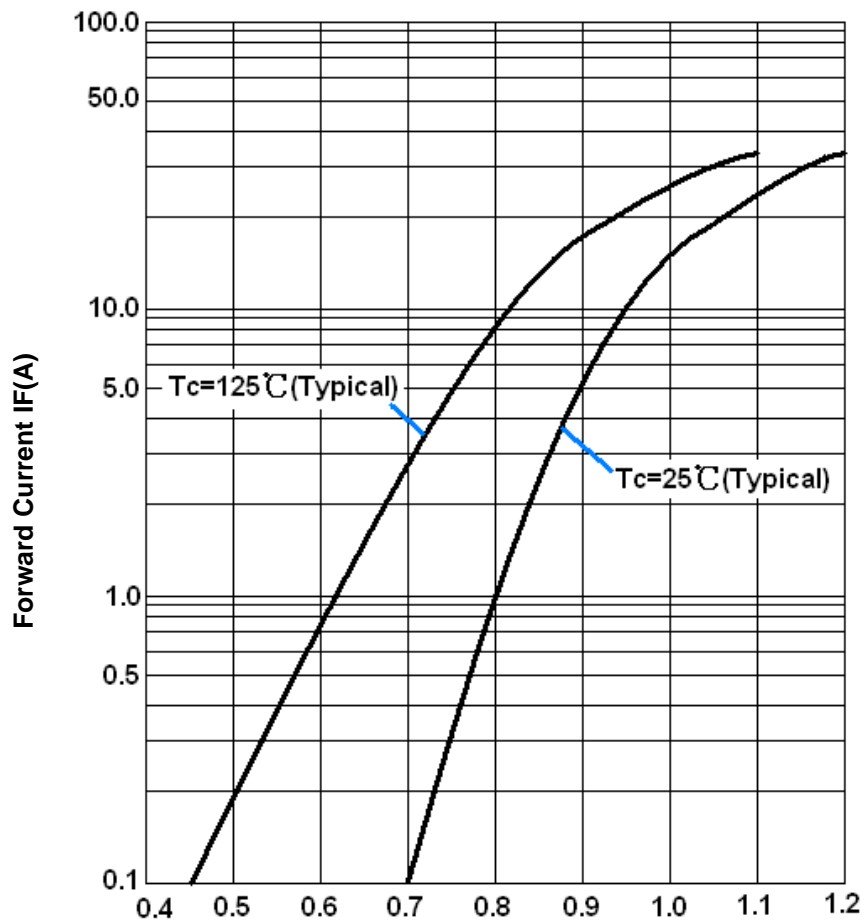
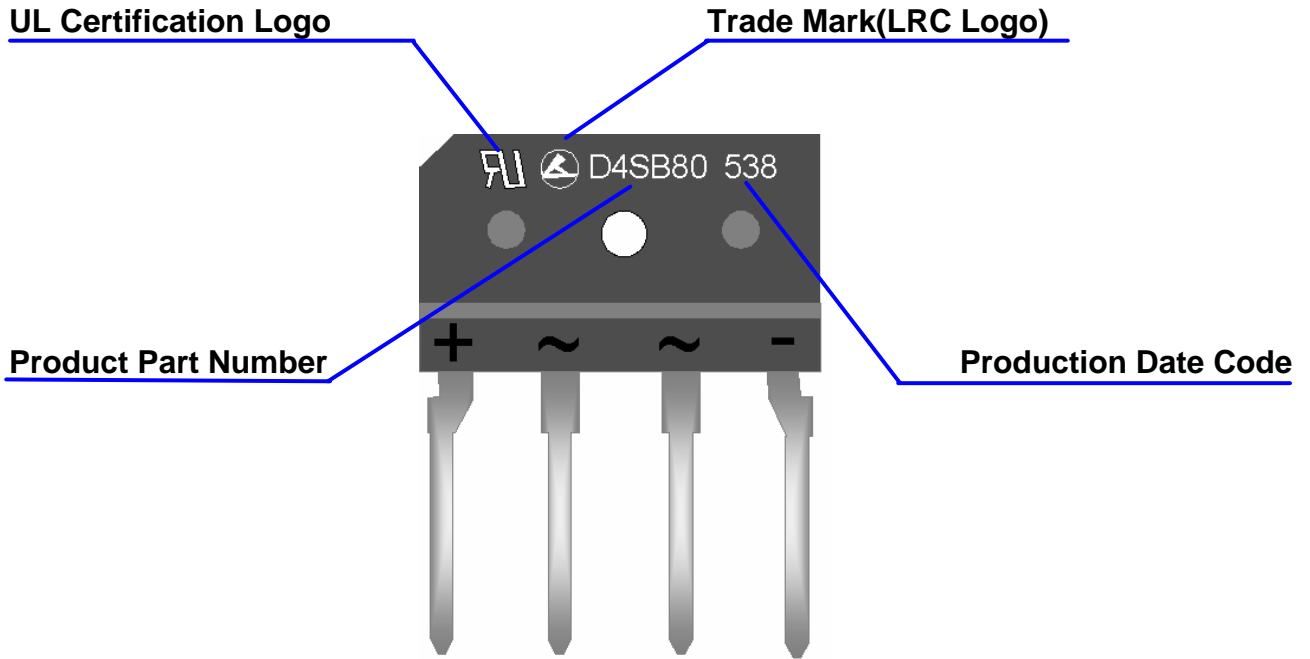

Fig.4 Forward Voltage



Marking Identification



Note: 1. *Production Date Code* contains 3 digits. For example "538", the first digit "5" stands for year 2005, and the other two digits "38" means week 38. So this product is made in the 38th week in 2005.

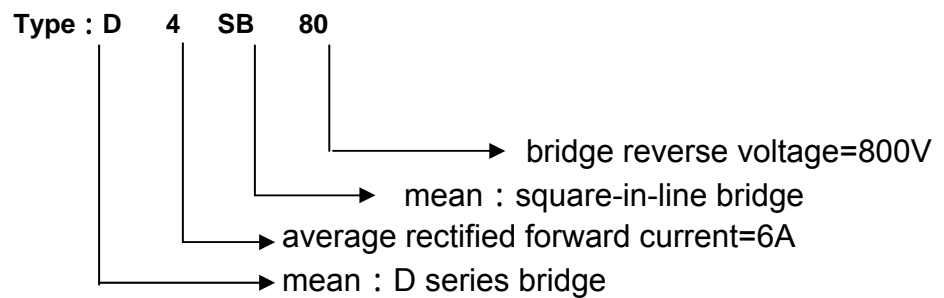

Packing

(Tube&Carton Package)

Packing Tube (normal length lead)

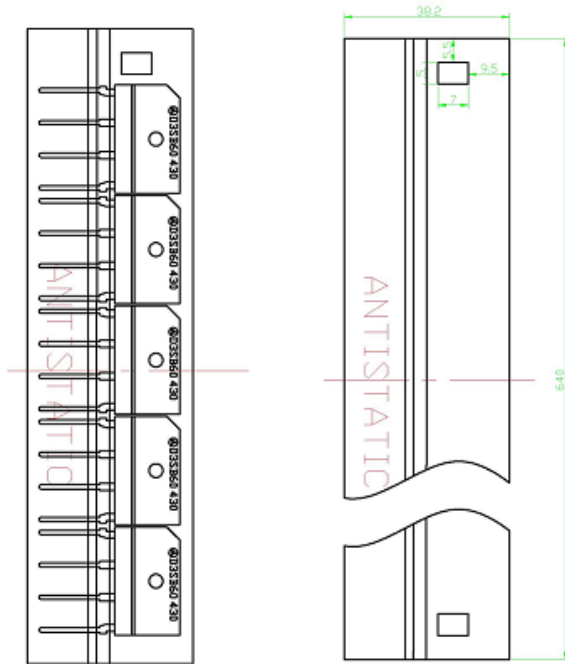

- 技术要求:
 1, 在管中部印字
 2, 字体颜色: 红色
 3, 印字尺寸: 25.5×3
 4, 管壁厚度: 0.6
 5, 未注圆角<0.5

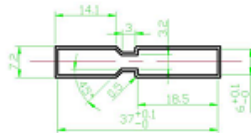

Technology Request :

- .Marking in Tube Centre
- .Marking Size:25.5*3mm
- .not label angle: < 0.5

- .Font Color:Red
- .Tube Thickness:0.6mm

- .Anti-static packing tube
- .25pcs per tube