

Optical System Achieves 1- μ m Operating Position Repeatability in this 4-way Switch

- A knife-edge mechanism in the optical system provides greater precision for a more stable output without faulty contact operation.
- Reduced size and weight (34 mm at operating section and 60 g total).
- Wear-resistant ceramic parts used in the measurement section.
- Two different output types available.



Ordering Information

■ List of Models

Output configuration	Contact form	Operation indicator	Cable length	Model
PNP open collector (+ common)	SPST-NC	ON when not operated	1 m	D5F-2B10
			3 m	D5F-2B30
NPN open collector (- common)	SPST-NO	ON when operated	1 m	D5F-3C10
			3 m	D5F-3C30

Specifications

■ Ratings

Power supply voltage	12/24 VDC \pm 10%, ripple (p-p): 10% max.
Output current	100 mA max.
Power consumption	30 mA max.
Leakage current	0.15 mA max.
Residual voltage	2 V max.

■ Characteristics

Degree of protection	IP67
Life expectancy (see note 2)	Mechanical: 5,000,000 operations min. Electrical: 5,000,000 operations min.
Operating speed	1 μ m/s to 50 cm/s
Max. operating frequency	60 operations/minute max.
Insulation resistance	100 M Ω min. (at 500 VDC) between each terminal and ground
Dielectric strength	1,100 VAC between each terminal and ground
Vibration resistance	Malfunction: 10 to 500 Hz, 1.3-mm double amplitude
Shock resistance	Malfunction: 300 m/s ² min.
Repeat accuracy	1 μ m max. (see note 3)
Ambient temperature (see note 4)	Operating: -10°C to 60°C (with no icing)
Ambient humidity	Operating: 30% to 95%
Weight	Switch body: approx. 50 g; Cord: 23 g/m

- Note:**
1. The above figures are initial values.
 2. Life expectancy values are calculated at an operating temperature of 5°C to 35°C, and an operating humidity of 40% to 70%. Contact your OMRON sales representative for more detailed information on other operating environments.
 3. Measurements were conducted repeatedly at the same point. The value is 1 μ m max. for 200 measurements. For other conditions in detail, contact your OMRON sales representative.
 4. The ambient operating temperature varies depending on the current. Refer to the following *Engineering Data*.

Deviation	10 μm max. after 1,000,000 operations
Temperature coefficient	$\pm 50 \times 10^{-6}/^{\circ}\text{C}$ max.

Note: :Operating position fluctuation rate for a change of 1°C in the ambient temperature.

■ Operating Characteristics

OF max.	2.45 N
RF min.	0.98 N
PT max.	0.5 mm
MD max.	20 μm
TT min.	2.2 mm

Engineering Data

The permissible operating temperature range varies with the current flow as follows:

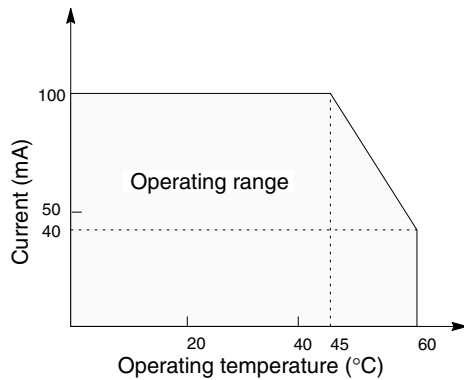

Repeat Accuracy (Reference Data)

D5F-2B10

No. 1 ON

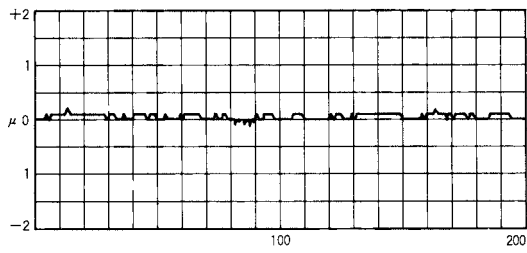

No. 2 ON

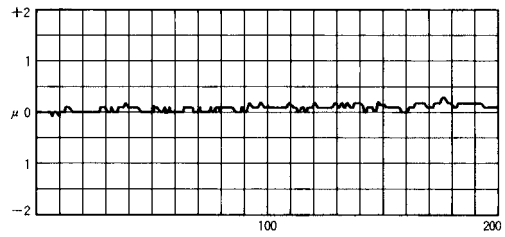

No. 1 OFF

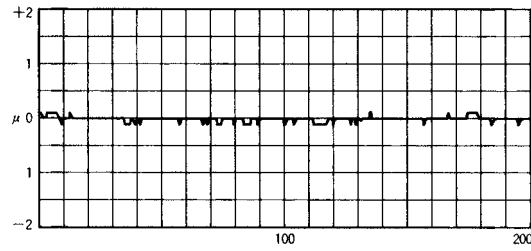

No. 2 OFF

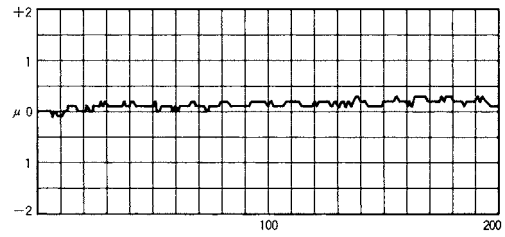

No. 3 ON

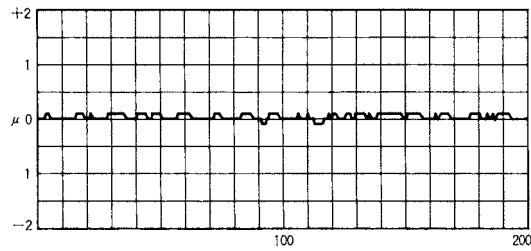

No. 4 ON

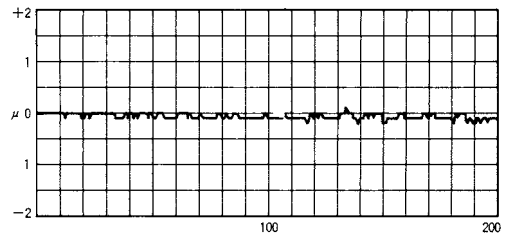

No. 3 OFF

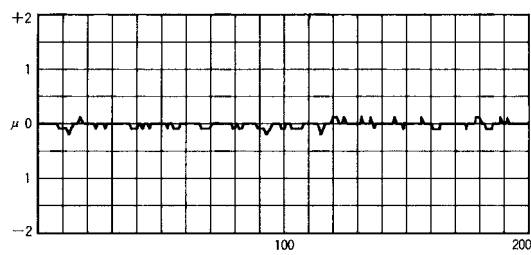

No. 4 OFF

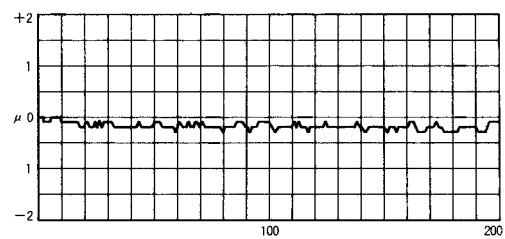

Nomenclature

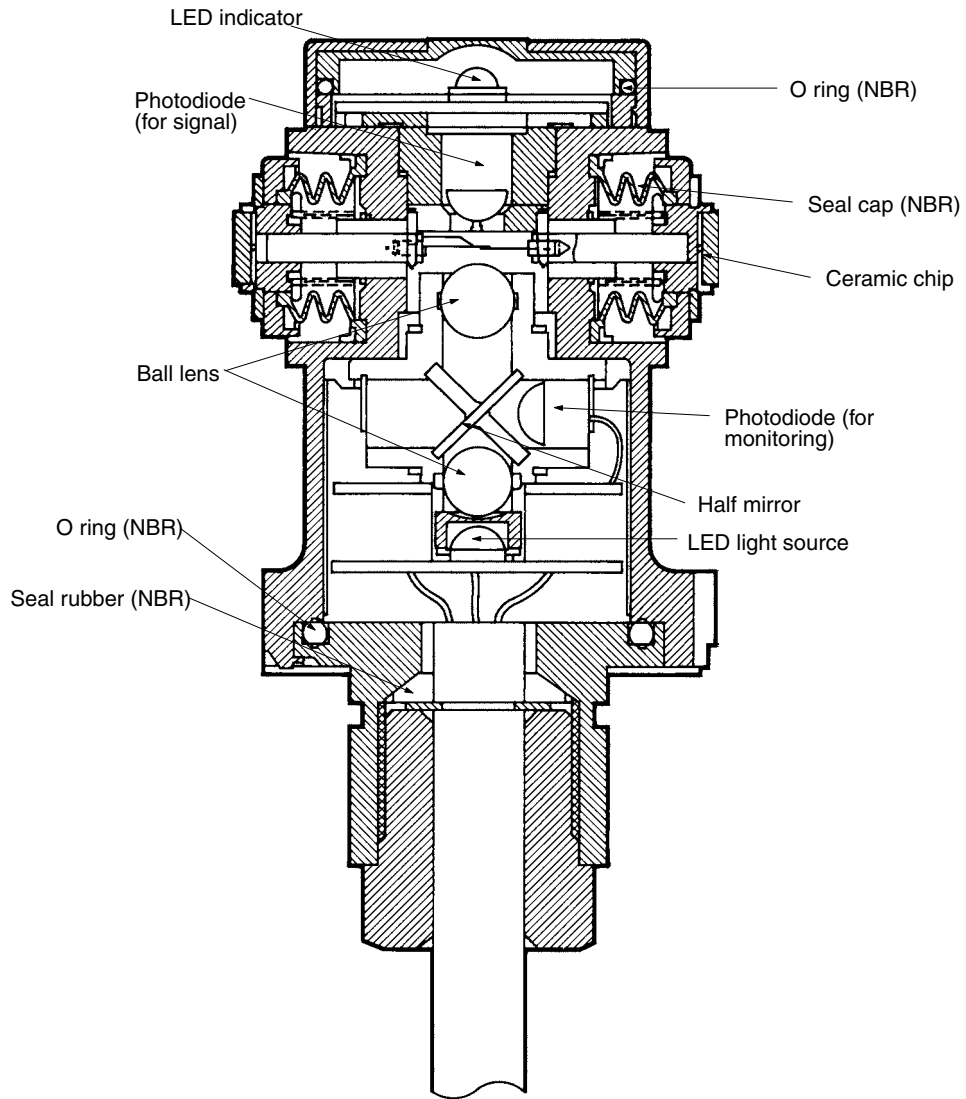

www.DataSheet4U.com

Dimensions

Note: All units are in millimeters unless otherwise indicated.

D5F-2B□0
D5F-3C□0

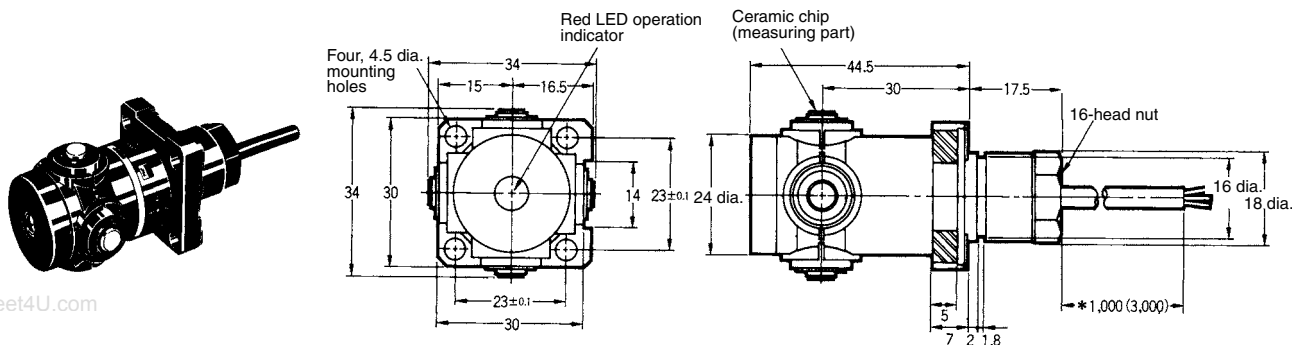

Replace □ in the model number with the code for the Switch you require (i.e. 1 for Switches with a 1,000-mm cable and 3 for Switches with a 3,000-mm cable).

Note: The degree of parallelism and squareness of the ceramic chip are $\pm 5 \mu\text{m}/5 \text{ mm}$ against the reference plane.

Installation

■ Output Circuit

D5F-2B□0

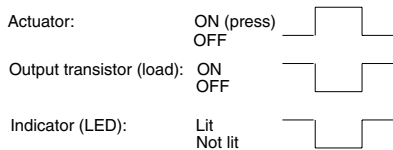
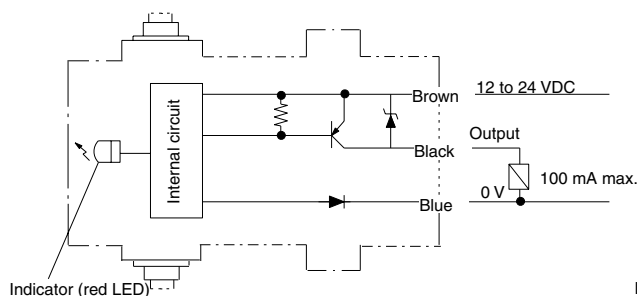

D5F-3C□0

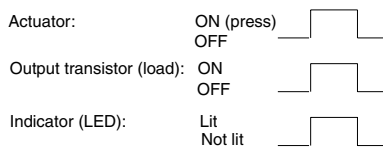
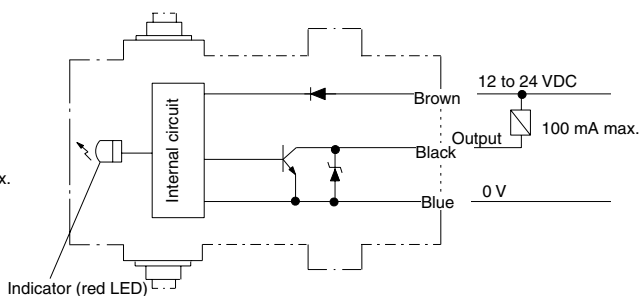

Precautions

■ Correct Use

Do not impose any force exceeding 29.42 N on the cord, otherwise the cord may break. Make sure that the bending radius of the cord is at least 20 mm.

Connections

Take the residual voltage (2 V max.) into consideration when connecting a load or power supply.

When the internal circuit of the D5F is open, there will be a leakage current of 0.15 mA maximum and a residual voltage on the load. Check the release voltage of the load before use.

Handling

Do not drop or impose external force, such as shock, on the D5F. Otherwise, the D5F may malfunction or lose its accuracy.

Operating Environment

The operating environment has a significant effect on the D5F. Consult your OMRON representative before using the D5F in environments with different cutting oil, solvent, or gas.

Noise

If the power supply line is affected by excessive noise, the D5F may lose its accuracy.

Refer to the following and if the noise level is excessively high, take a proper countermeasure, such as the use of a noise filter.

Level	Influence on accuracy
1 kV p-p	3 μ m max.
1.5 kV p-p	5 μ m max.

Make sure that the ripple rate of the power supply is 10% maximum.

Operation

Do not press two or more plungers at the simultaneously, otherwise the D5F may break.

Example: Two-directional Operation

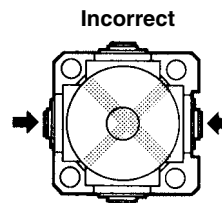

Precautions

Light Source Burnout

The D5F does not use any contacts. Therefore no contact failures will result. If the LED light source burns out due to noise or any other cause, the following will result.

D5F-2B□0: The output transistor is kept turned OFF.

D5F-3C□0: The output transistor is kept turned ON.

Take the above into consideration and install a stopper mechanism so that the machine will not be damaged or the Switch will not be pressed excessively if the output transistor does not operate properly.

Adhesive Agent

The ceramic chips are glued with epoxy resin that may deteriorate due to cutting oil or warm solvent. In the worst case, the chips may fall off. The chips can withstand certain cutting oils or acetone. Check the operating environment before using the D5F.

POHL-Electronic
 Neuendorf Straße 18b
 16761 Hennigsdorf
www.pohl-electronic.de

ALL DIMENSIONS SHOWN ARE IN MILLIMETERS.

To convert millimeters into inches, multiply by 0.03937. To convert grams into ounces, multiply by 0.03527.