

MOS INTEGRATED CIRCUIT

μ PD6144

CMOS LSI FOR 6 lines \times 16 columns CHARACTER DISPLAY ON SCREEN

The μ PD6144 CMOS LSI for on-screen character display allow the time of day, channel numbers, chapter numbers, etc. to be displayed on a television screen when used in combination with a microprocessor within a television set or video disk unit. In a video camera or a VTR (video tape recorder), this LSI allow the time of day, date, etc. to be recorded overlapping the video signals.

Characters are displayed in a 6-by-9 dot pattern with no space between characters. It is thus possible to display graphics or Japanese kanji characters by combining two or more characters. The μ PD6144C-001 and μ PD6144G-101 are identical in character format. They differ only in package type, the former being a 16-pin DIP (Dual In-line Package) and, the latter, a 16-pin SOP (Small Out-line Package).

FEATURES

- Number of characters displayed: 6 lines x 16 columns
- Number of character types: 64
- Character size: Any one of 2H, 4H, 6H and 8H per dot can be selected.
- Character color: Any one of 8 colors can be selected for each character.
- Background: No background, black fringe, square background, or solid background selectable for each image (for square background and solid background, any one of 8 colors is selectable)
- Dot matrix: 6-by-9 dot pattern with no space between characters
- Blink: Blink ratio is selectable at 1:1, 1:3, or 3:1.
- Mask pulse: (Code Option) Can be output in vertical direction for each line
- Double-speed scan TV mode adaptation: (Code Option) Switching of the vertical-scan lines counter adapts to a system in which one field contains 525 scan lines.
- Interface with microprocessor: 8-bit serial input format
- Power supply: +5 V single power supply
- Construction: Low-power-consumption CMOS

ORDERING INFORMATION

PART NUMBER	PACKAGE
μ PD6144C-001	16-pin plastic DIP (300 mil)
μ PD6144G-101	16-pin plastic SOP (375 mil)

BLOCK DIAGRAM

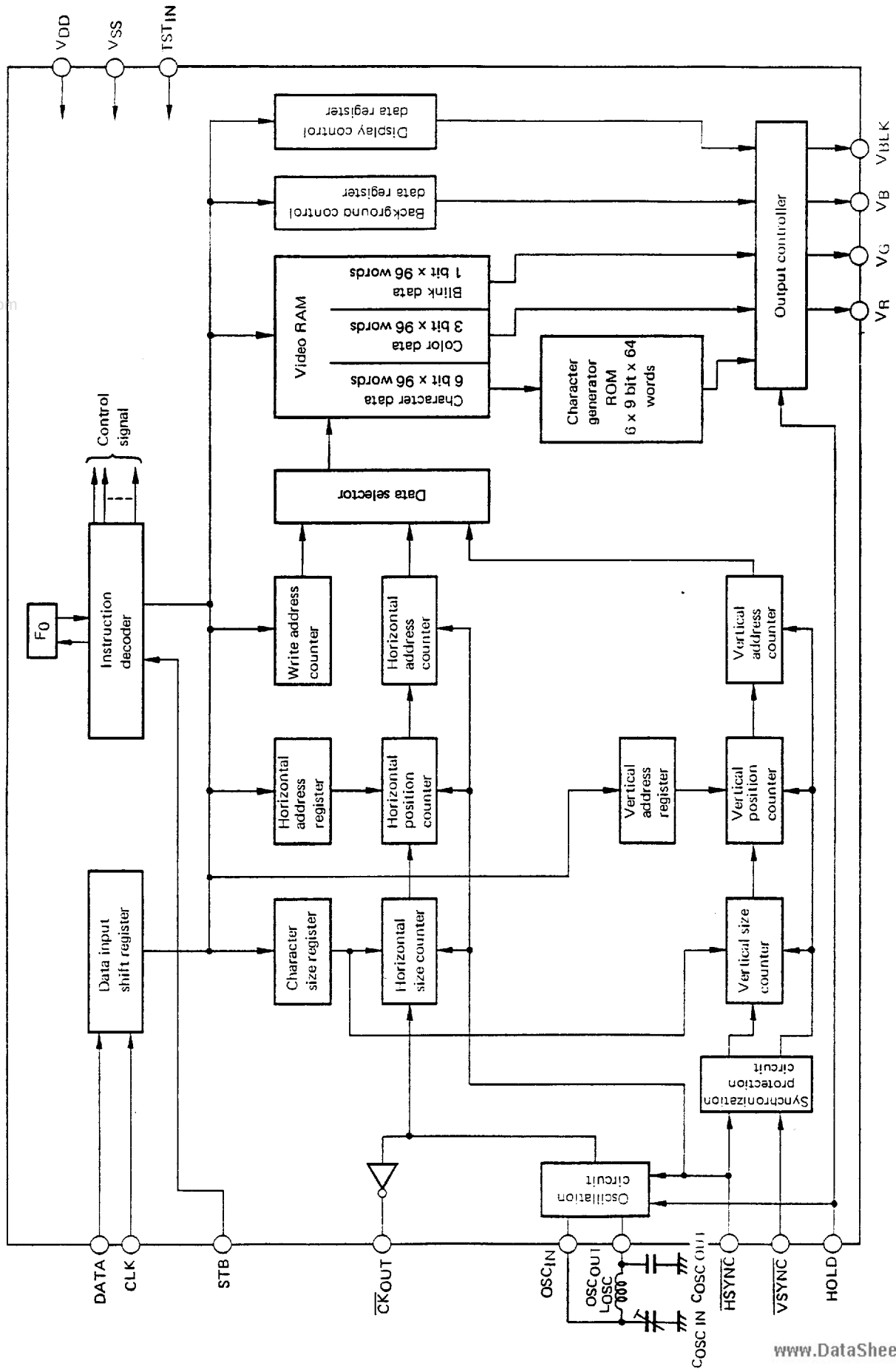

ABSOLUTE MAXIMUM RATINGS (T_a = 25 °C)

Supply Voltage	V _{DD} -V _{SS}	7	V
Input Voltage	V _{IN}	V _{DD} + 0.3 > V _{IN} > V _{SS} - 0.3	V
Output Voltage	V _{OUT}	V _{DD} + 0.3 > V _{OUT} > V _{SS} - 0.3	V
Operating Temperature	T _{opt}	-20 to +75	°C
Storage Temperature	T _{stg}	-40 to +125	°C
Output Current	I _O	±5	mA

RECOMMENDED OPERATING RANGE

CHARACTERISTIC	SYMBOL	MIN.	TYP.	MAX.	UNIT
Supply Voltage	V _{DD} -V _{SS}	4.5	5.0	5.5	V
Oscillation Frequency	f _{osc}	4.0		7.0	MHz
Operating Temperature	T _{opt}	-10	+25	+60	°C

ELECTRICAL CHARACTERISTICS

(T_a = 25 °C, V_{DD} = 5.0 V, V_{SS} = 0 V, L_{osc} = 39/56 μH, C_{osc} OUT = 30 pF, C_{osc} IN = 5 to 30 pF)

CHARACTERISTIC	SYMBOL	MIN.	TYP.	MAX.	UNIT	TEST CONDITION
Supply Voltage	V _{DD} -V _{SS}	4.5	5.0	5.5	V	f _{osc} = 7.0 MHz
Current Consumption	I _{DD}			10	mA	
Control Input H-level Voltage	V _{IH}	2.4			V	
Control Input L-level Voltage	V _{IL}			0.8	V	
Synchronization Signal Input H-level Voltage	V _{IH}	2.4			V	
Synchronization Signal Input L-level Voltage	V _{IL}			0.8	V	
Signal Output H-level Voltage	V _{OH}	4.5			V	I _{OH} = -1.0 mA
Signal Output L-level Voltage	V _{OL}			0.5	V	I _{OL} = 1.0 mA
Clock Output H-level Voltage	V _{OH}	4.5			V	I _{OH} = -0.5 mA
Clock Output L-level Voltage	V _{OL}			0.5	V	I _{OL} = 0.5 mA
Hold Signal Input H-level Voltage	V _{HHOLD}	4.5			V	
Hold Signal Input L-level Voltage	V _{LHOLD}			2.5	V	

Note: Control input DATA, CLK, STB
 Synchronization signal input HSYNC, VSYNC
 Signal output VR, VG, VB, VBLK
 Clock output CKOUT
 Hold signal input HOLD

CONNECTION DIAGRAM (Top View)

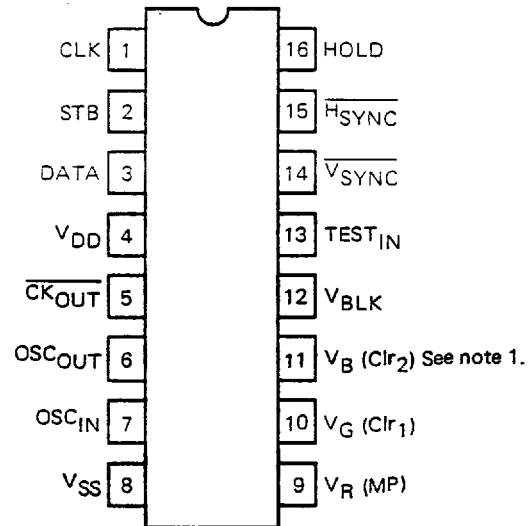

- Notes:**
1. Characters in parentheses indicate that the terminal is used with a mask-pulse code option: in that case, terminal No. 9 (V_R) is the mask-pulse input, and terminals Nos. 10 (V_G) and 11 (V_B) are character outputs. Terminal No. 9 is usually selected as the character output.
 2. CONNECTION DIAGRAM above applies to both the 16-pin DIP (μ PD6144C-xxx) and 16-pin mini-flat package (μ PD6144G-xxx).
 3. The μ PD6143C-xxx and μ PD6143G-xxx (2 lines x 16 characters on screen) are also identical in terminal layout.

PIN DESCRIPTION

Symbol	Terminal Name	Description
V _{DD}	Power supply terminal	For supply of +5 V power
V _{SS}	Ground terminal	Connects to system ground.
DATA	Serial data input terminal	Input terminal for control data. Data is read via this terminal in synchronization with the clock applied to the CLK terminal.
CLK	Clock input terminal	Input terminal for data reading clock. Data applied to the DATA terminal is read at each rising edge of the clock signal on this terminal.
STB	Strobe input terminal	Input terminal for the strobe signal generated after input of serial data. Eight data bits are read at each rising edge of the pulse applied to the STB terminal. If the eight bits are character data, the data address is incremented by one at the falling edge of each pulse.
OSC _{IN} OSC _{OUT}	Oscillation terminal	Terminal that connects to an oscillation capacitor and coil.
$\overline{\text{H}}\text{SYNC}$	Horizontal synchronization signal input terminal	Input terminal for horizontal synchronization signal. Oscillation occurs when $\overline{\text{H}}\text{SYNC}$ is high, being synchronized with the rising edge of $\overline{\text{H}}\text{SYNC}$. Input data when this signal is active low.
$\overline{\text{V}}\text{SYNC}$	Vertical synchronization signal input terminal	Input terminal for vertical synchronization signal. Input data when this signal is active low.
See Note. V _R V _G V _B	Character signal output terminals	Output terminals for character data that corresponds to R (red), G (green), and B (blue). These signals are active-high.
V _{BLK}	Blanking signal output terminal	Output terminal for the blanking signal used to cut the video signal. This signal is active-high.
$\overline{\text{C}}\text{KOUT}$	Clock output terminal	Inverted OSC OUT terminal. To connect another type of on-screen IC in parallel with the $\mu\text{PD6144C-001}$ or $\mu\text{PD6144G-101}$, connect this terminal to OSC _{IN} of the other IC.
HOLD	Hold terminal	Oscillation stops at low level. In addition, V _R , V _G , V _B , and V _{BLK} outputs all go low. (Usually leave these outputs high.)
TEST _{IN}	Test clock input terminal	Input terminal for test clock. (Usually connect this terminal to V _{SS} .)

Note: If terminal No. 9 (V_R) is used as the mask pulse output terminal (MP) for a mask code option, characters are output via terminals Nos. 10 (Clr₁) and 11 (Clr₂).
In all other cases, characters are output via terminal No. 9.

Command Format

All control commands available with the μ PD6144C-xxx or μ PD6144G-xxx are in eight-bit serial input format. A command is executed by input of a strobe pulse after eight-bit serial data has been input.

Before starting a program, transmit the format reset command by setting "FR = 1" with the format selection command to release the test mode.

μ PD6144C-xxx and μ PD6144G-xxx Commands

Description	F ₀	D ₇	D ₆	D ₅	D ₄	D ₃	D ₂	D ₁	D ₀
Display character data	0	0	0	C ₅	C ₄	C ₃	C ₂	C ₁	C ₀
Color blinking data for each character *	0	1	0	0	0	Blink	R	G	B
Character display line address	0	1	0	0	1	0	AR ₂	AR ₁	AR ₀
Character display column address	0	1	0	1	0	AC ₃	AC ₂	AC ₁	AC ₀
Background specification*	0	1	1	0	BS ₄	BS ₃	R _b	G _b	B _b
Write synchronization, smoothing on/off, and display on/off	0	1	1	1	0	0	D _{sync}	SM	DO
Blinking and oscillation control	0	1	1	1	1	0	BL ₂	BL ₁	OSC
Format selection	X	1	1	1	1	1	1	F ₀	FR
Display-position vertical address	1	0	1	1	V ₄	V ₃	V ₂	V ₁	V ₀
Display-position horizontal address	1	1	1	0	H ₄	H ₃	H ₂	H ₁	H ₀
Character size specification*	1	1	0	S ₅	S ₄	0	AR ₂	AR ₁	AR ₀
Test mode setting	1	1	1	1	0	T ₃	T ₂	T ₁	T ₀

Note: Change of commands due to use of a mask pulse (mask code option)

One character (color) output is invalid if a mask code option makes terminal No. 9 the mask pulse output terminal (MP).

This requires that three commands (color/blinking data for each character command, background specification command, and character size specification command) be changed as follows:

Description	F ₀	D ₇	D ₆	D ₅	D ₄	D ₃	D ₂	D ₁	D ₀
Color/blinking data for each character	0	1	0	0	0	Blink	0	Clr ₁	Clr ₀
Background specification	0	1	1	0	BS ₄	BS ₃	0	Clr ₁	Clr ₀
Character size and mask pulse specification	1	1	0	MP	S ₄	0	AR ₂	AR ₁	AR ₀

Note: No command changes are necessary, however, for the mask code option that allows adaptation to a double-speed scan TV mode.

Format Selection and Format Resetting (Test Mode Releasing)

The μ PD6144C-xxx or μ PD6144G-xxx commands contain nine bits, but the shift registers for serial interfacing with external units accept only eight bits. Instructions are therefore divided into two banks (banks 0 and 1). Bank selection is performed by one bit of the format selection command.

Commands belonging to bank 0 ($F_0 = 0$)

- Display character data
- Color/blinking data for each character
- Character display line address
- Character display column address
- **Background specification**
- Write synchronization, smoothing on/off, and display on/off
- **Blinking and oscillation control**

Commands belonging to bank 1 ($F_0 = 1$)

- **Display-position vertical address**
- **Display-position horizontal address**
- **Character size specification**

Format resetting (Test mode release)

Setting the F_R bit of the format selection command to 1 releases the test command mode and thus resets the command contents mentioned below. No command can be accepted while the test command mode remains set. Before the start of a program, therefore, reset the existing format to release the test command mode.

Command that is reset:

A command that properly sets the contents of all line-size registers (AR_0 to AR_5) for ($S_5, S_4 = 0, 0$).

[The minimum size is specified for all lines.]

In addition, if a mask code option makes terminal No. 9 the mask pulse output terminal, the contents of all line-size registers (AR_0 to AR_5) must be properly set to give ($S_4 = 0$), so that no mask pulses are output from any line ($MP = 0$).

If the above command is to remain set and only the test command mode is to be released, use the test command mode release instruction ($F_0, D_7, D_6, D_5, D_4, D_3, D_2, D_1, D_0$) = (1,1,1,1,0,0,0,0,0)

Format selection command

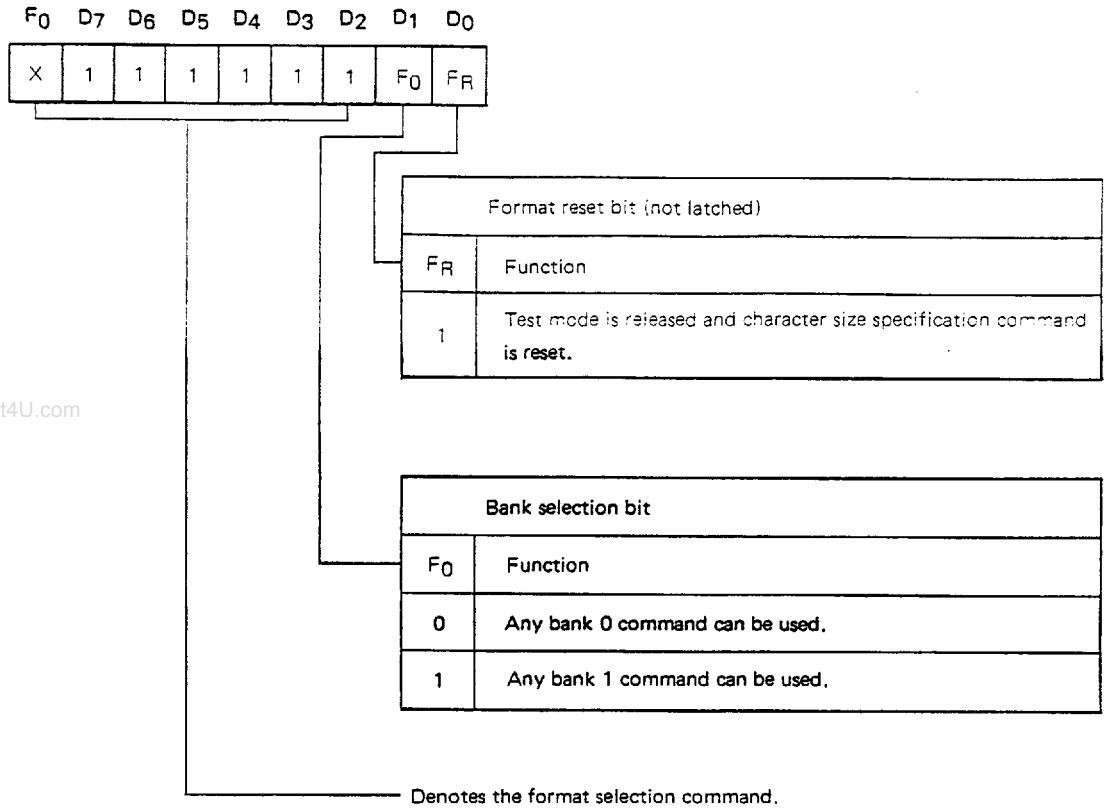

μPD6144C-001 and μPD6144G-101 Character Patterns

The μPD6144C-001 and μPD6144G-101 display 64 character patterns on a television screen. With a mask code option, it is also possible to change any character pattern. Code 3FH however, cannot be assigned to any character pattern, because this code remains fixed in a display OFF state at all times.

The μPD6144C-001 and μPD6144G-101 display exactly the same character patterns.

Character patterns available with μ PD6144C-001 and μ PD6144G-101

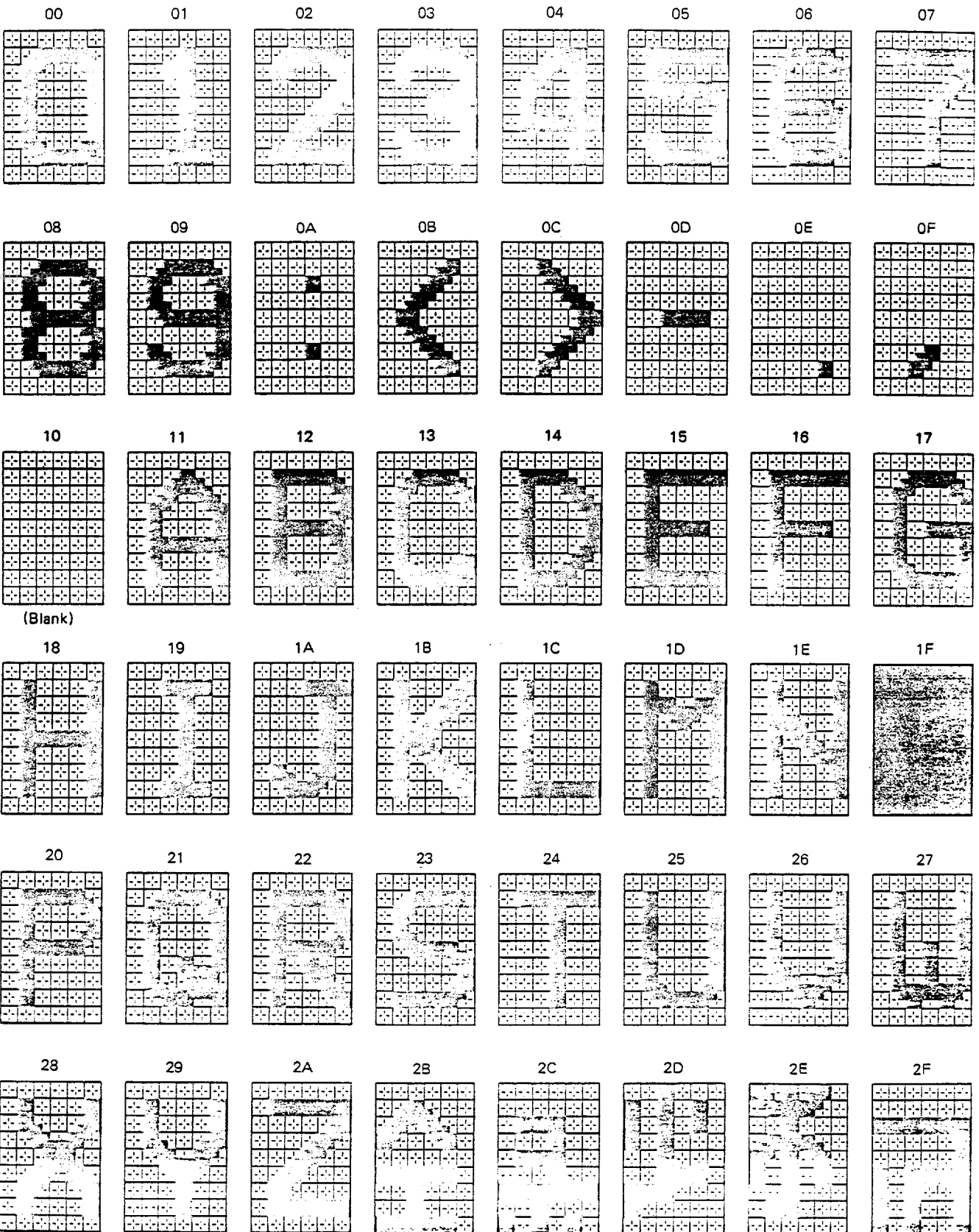

www.DataSheet4U.com

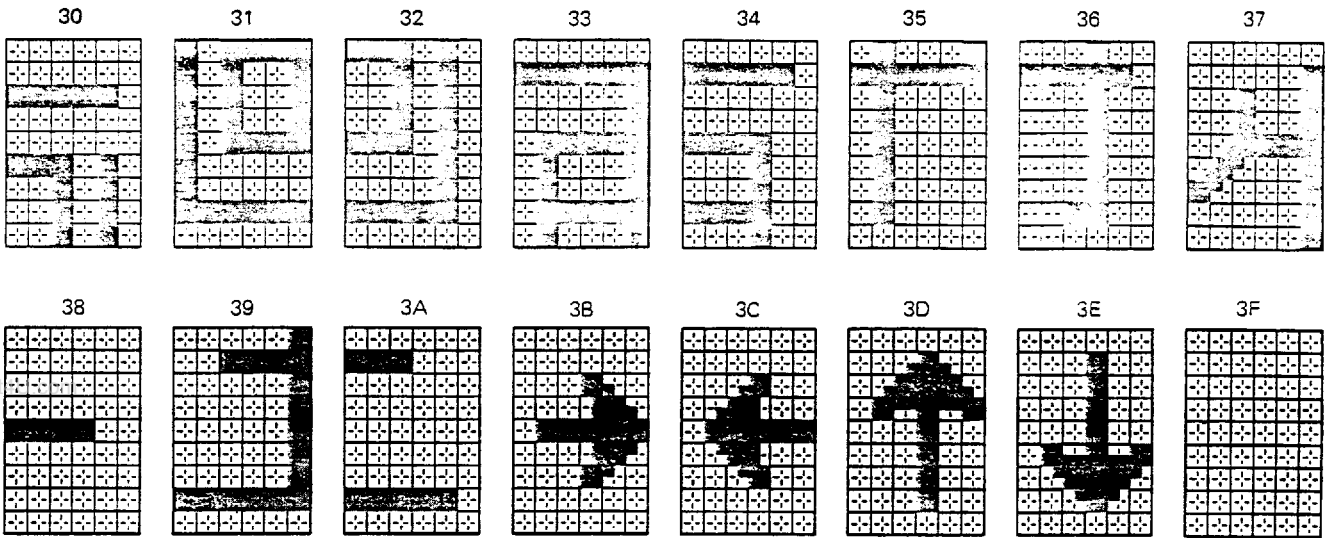

Display Off
Data
(No character pattern
can be entered.)

Character Display

A maximum of 96 characters per image can be displayed in a 6-line x 16-column format, as shown below.

AC3,AC2,AC1,AC0		0000	0001	0010	0011	0100	0101	0110	0111	1000	1001	1010	1011	1100	1101	1110	1111
AR2,AR1,AR0	000																
	001																
	010																
	011																
	100																
	101																

www.DataSheet4U.com

Display Character Data Writing and Color Blinking Data for Each Character Writing

Data write addresses can be set directly into the address counter using the character-display line address command and character-display column address command.

After setting write addresses, input color and blinking data for each character using the color blinking data for each character command. The data are then stored in an internal register.

Following the above data input operation, input display character data using the display character data command. The color and blinking data that has been stored in an internal register are then written to the video RAM, together with the input display character data, at the rising edge of the strobe pulse that is input at the end of the display character data command.

Write addresses are incremented, as shown below, at the falling edge of each strobe pulse generated when display character data is input.

To write character data in succession without changing the color or blinking data, input only the display character data command.

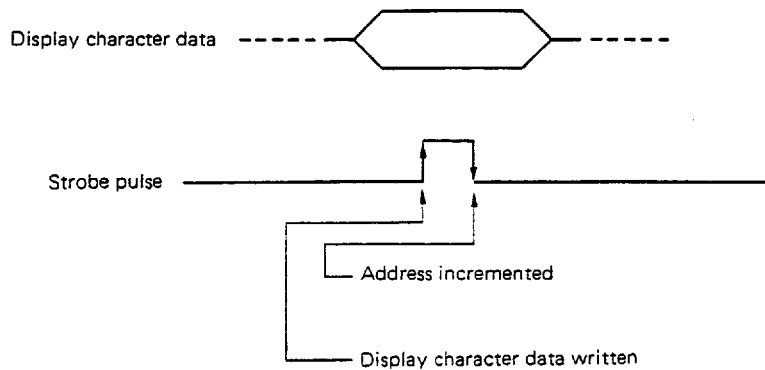

Column address counters AC₃, AC₂, AC₁, AC₀

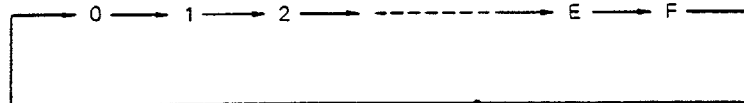

Line address counters AR₂, AR₁, AR₀

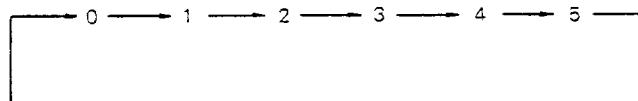

Example: Writes the following data in the area of line 0/column 0 to line 0/column F:

Character colors	B	B	B	B	B	R	R	R	R	R	R	G	G	G	G	G
	R: Red, G: Green, B: Blue															
Character blinking	OFF	OFF	OFF	ON	ON	ON	ON	ON	ON	ON	ON	OFF	OFF	OFF	OFF	OFF
Display characters	0	1	2	3	4	5	6	7	8	9	9	9	9	9	9	9

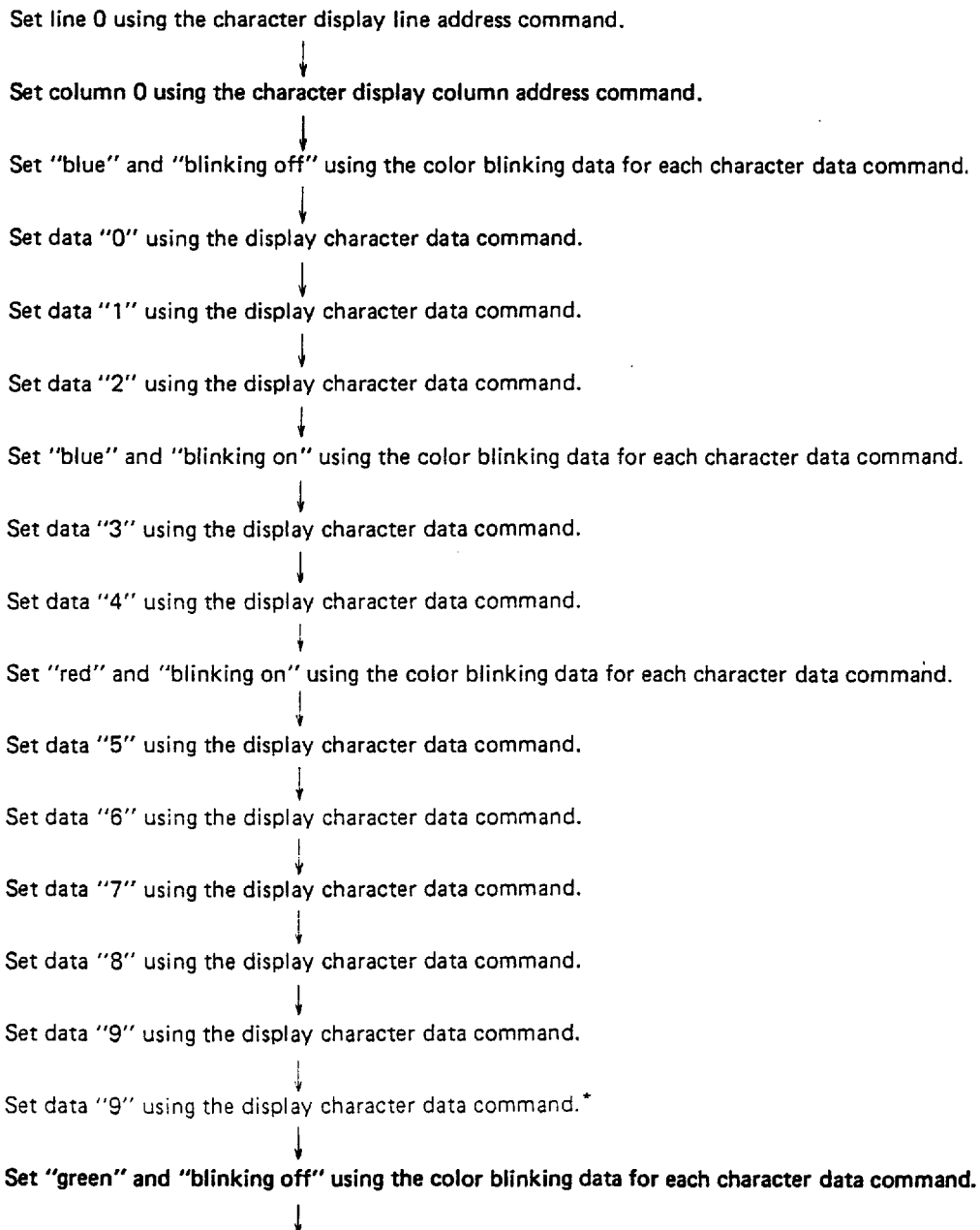

Set data "9" using the display character data command.



Set data "9" using the display character data command.*



Set data "9" using the display character data command.*



Set data "9" using the display character data command.*



Set data "9" using the display character data command.*

* Data is set simply by sending a strobe signal without eight-bit serial data.

Character display line address command

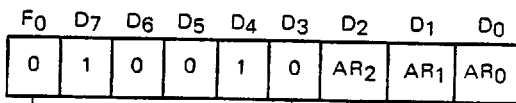

Line address bits			Function
AR ₂	AR ₁	AR ₀	
0	0	0	Sets the 1st line
0	0	1	Sets the 2nd line
?	?	?	?
1	0	1	Sets the 6th line

Do not set addresses other than 0 through 5.

Identifies the character display line address command.

Character display column address command

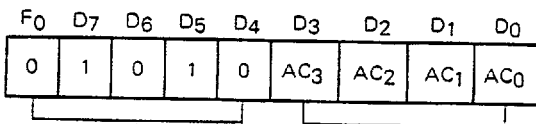

Column address bits				Function
AC ₃	AC ₂	AC ₁	AC ₀	
0	0	0	0	Sets the 1st column
0	0	0	1	Sets the 2nd column
?	?	?	?	?
1	1	1	1	Sets the 8th column

Identifies the character display column address command.

Color blink data for each character command

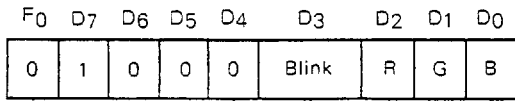

Character color specification bits			
R	G	B	Character color
0	0	0	Black
0	0	1	Blue
0	1	0	Green
0	1	1	Cyan
1	0	0	Red
1	0	1	Magenta
1	1	0	Yellow
1	1	1	White

Blinking on/off specification bits	
Blink	Function
0	Blinking off (Not blink)
1	Blinking on (blinks)

Identifies the color blink data for each character command.

Display character data command

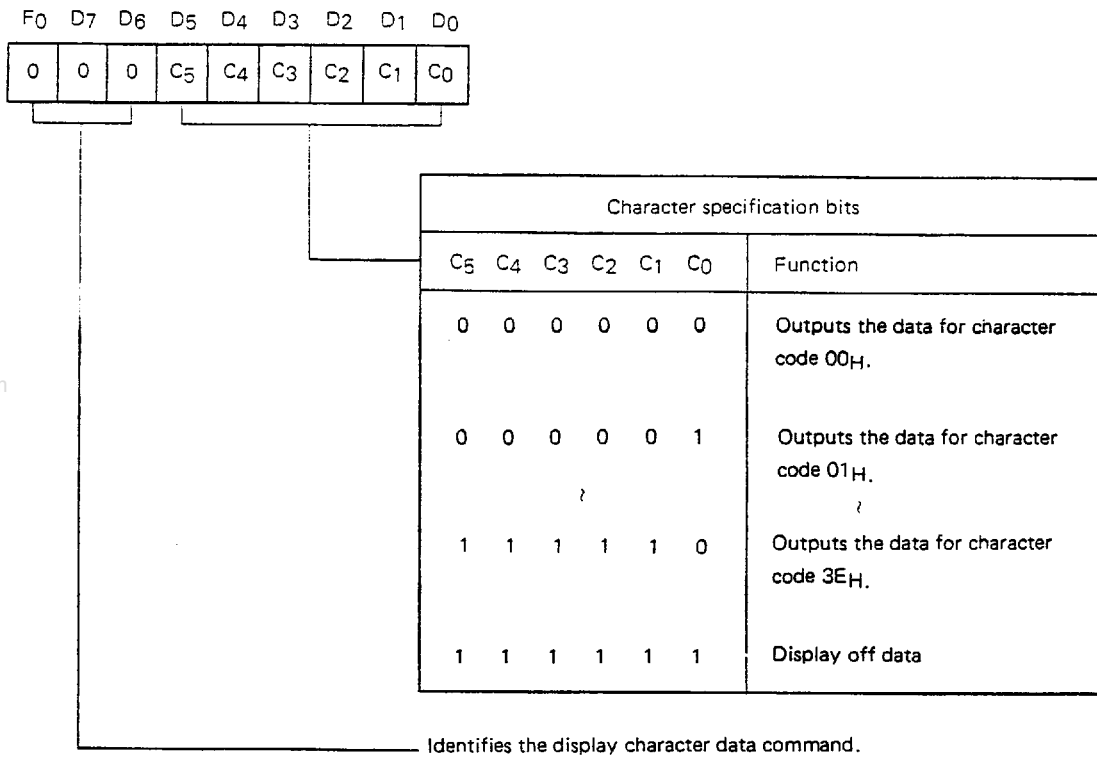

Oscillation Control

Because this IC allow oscillation to be turned on or off with the blinking/oscillation control command, power can be saved by stopping oscillation while no character display takes place. Character output remains executable even after oscillation has been stopped; to output characters in the oscillation off state, use the display control (display off) command in conjunction with the blinking/oscillation control command.

Character Blinking

This IC allow character-by-character blinking with the blinking/oscillation control command. Use the color blink ing data for each character command to specify the character(s) to be blinked. Select a blinking ratio of 1:1, 1:3, or 3:1. (A blinking cycle of approximately 1 second is equivalent to 64 times the vertical cycle.)

Blinking/oscillation control command

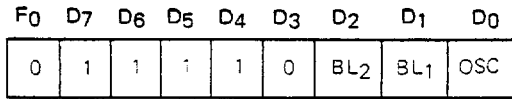

Oscillation control bits	
OSC	Function
0	Oscillation OFF
1	Oscillation ON

Blinking control bits		
BL ₂	BL ₁	Function
0	0	Blinking
0	1	ON 1 : OFF 3
1	0	ON 3 : OFF 1
1	1	ON 1 : OFF 1

Identifies the blinking/oscillation ON command.

Character display addresses

The start addresses for character display are determined, as shown below, according to the values specified by the display-position vertical address command

$$(F_0, D_7, D_6, D_5, D_4, D_3, D_2, D_1, D_0) = (1, 0, 1, 1, V_4, V_3, V_2, V_1, V_0)$$

and the display-position horizontal address command

$$(F_0, D_7, D_6, D_5, D_4, D_3, D_2, D_1, D_0) = (1, 1, 1, 0, H_4, H_3, H_2, H_1, H_0)$$

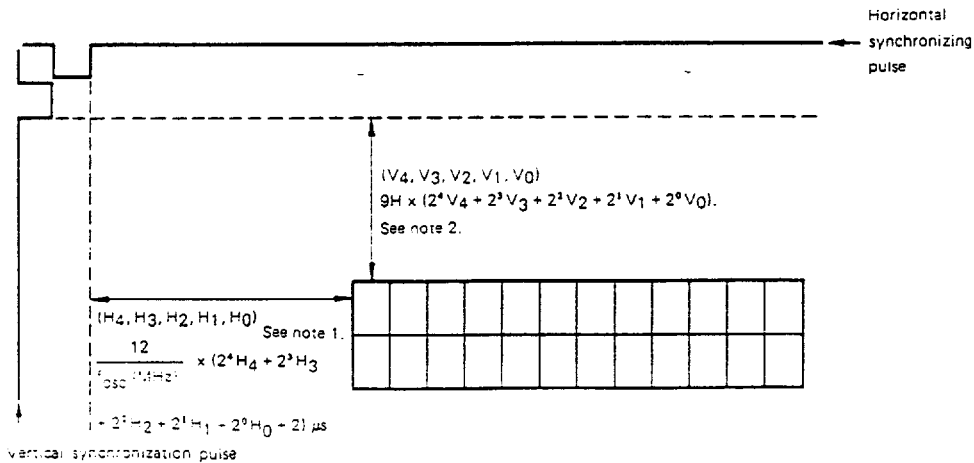

- Notes:**
1. Do not use $(H_4, H_3, H_2, H_1, H_0) = (0, 0, 0, 0, 0)$
 2. If a mask code option is used to adapt to a double-speed scanning system 9H should be read to mean 18H.

Display-position vertical address assignment command

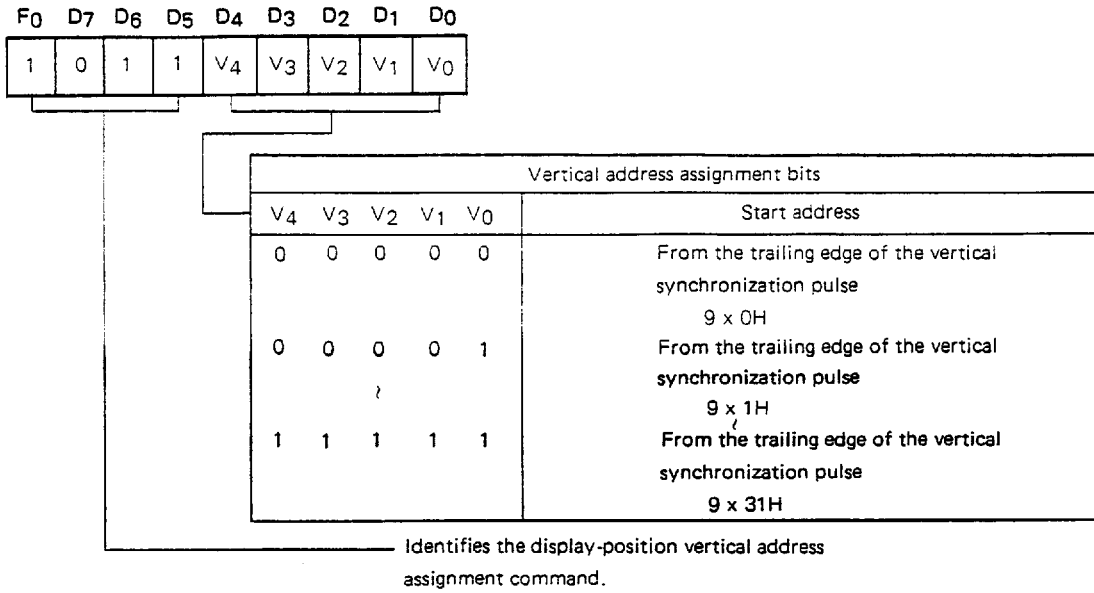

Display-position horizontal address assignment command

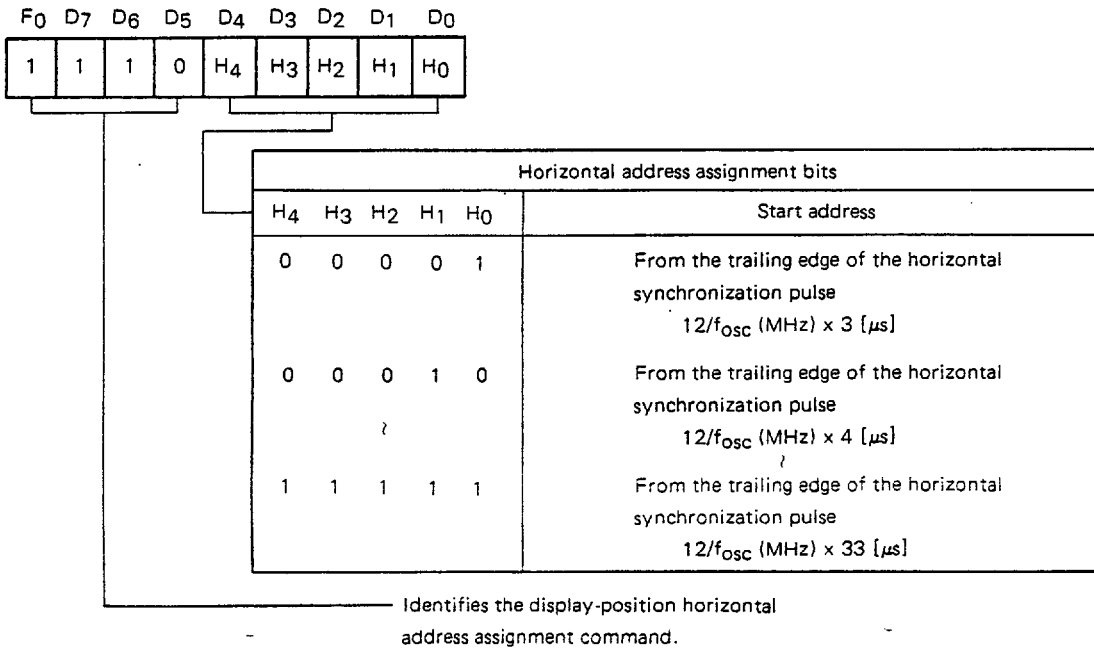

Note: Do not use (H₄, H₃, H₂, H₁, H₀) = (0, 0, 0, 0, 0)

Character Size Specification

One dot by 2H, 4H, 6H, or 8H vertical dots can be specified as the character size for each line. Use the character size specification command to specify lines and their character sizes. Note, however, that only two character sizes, i.e., one dot by 2H and 4H, are available if the mask pulse function has been selected via a mask code option. (See the description of the mask pulse.)

Character size specification command

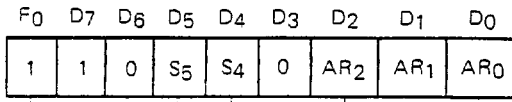

Line address selection bits			
AR2	AR1	AR0	Function
0	0	0	Selects the 1st line
0	0	1	Selects the 2nd line
1	0	1	Selects the 6th line

Do not set addresses other than 0 through 5.

Character size specification bits		
S5	S4	Dot size of character
0	0	Vertical 2H Horizontal t_{dot}
0	1	Vertical 4H Horizontal $2 \cdot t_{dot}$
1	0	Vertical 6H Horizontal $3 \cdot t_{dot}$
1	1	Vertical 8H Horizontal $4 \cdot t_{dot}$

$$t_{dot} = \frac{2}{f_{osc} \text{ (MHz)}} \mu s$$

Identifies the character size specification command.

Background Specification

The background type and color can be specified for each image using the background specification command. The background types available are: no background, black fringe, square background, and solid background. The colors available are: black, blue, green, cyan, red, magenta, yellow, and white.

Background specification command

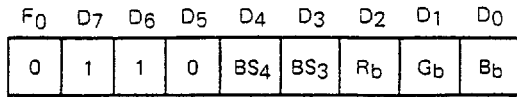

www.DataSheet4U.com

Background color specification bits			
R _b	G _b	B _b	Color of background
0	0	0	Black
0	0	1	Blue
0	1	0	Green
0	1	1	Cyan
1	0	0	Red
1	0	1	Magenta
1	1	0	Yellow
1	1	1	White

For no background or black border, set (R_b, G_b, B_b) = (0, 0, 0)

Background format specification bits		
BS ₄	BS ₃	Background format
0	0	No background
0	1	Black fringe
1	0	Square background
1	1	Solid background

Identifies the background specification command.

Display format in each background mode

Black fringe

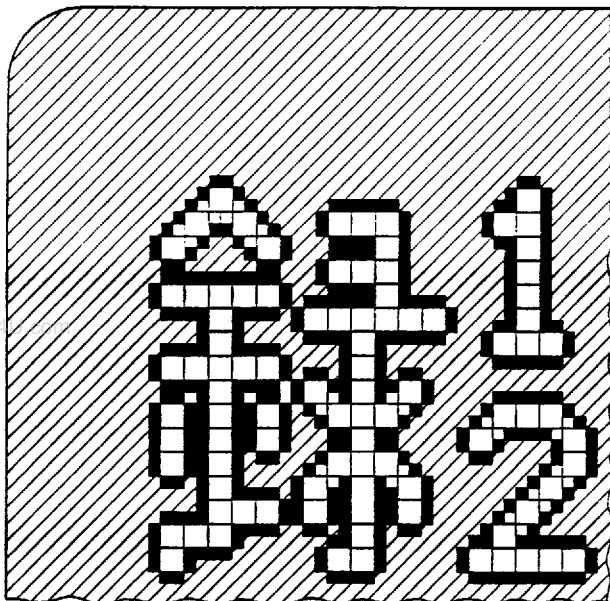

- Character color
- Background (black)
- Picture

Square background

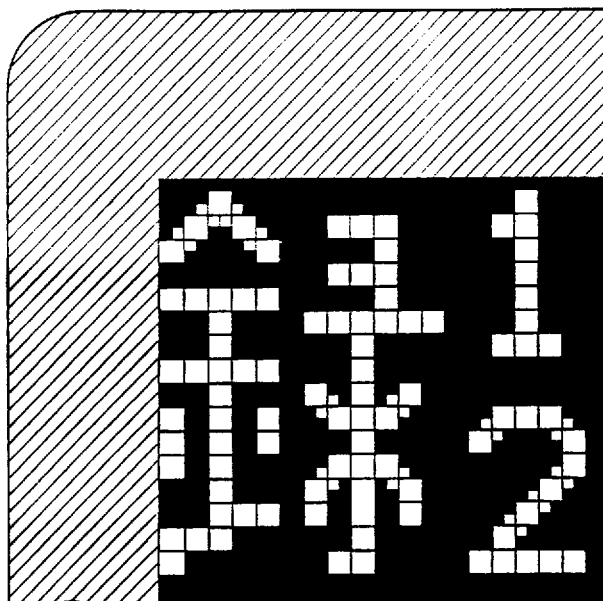

- Character color
- Background color
- Picture

Solid background

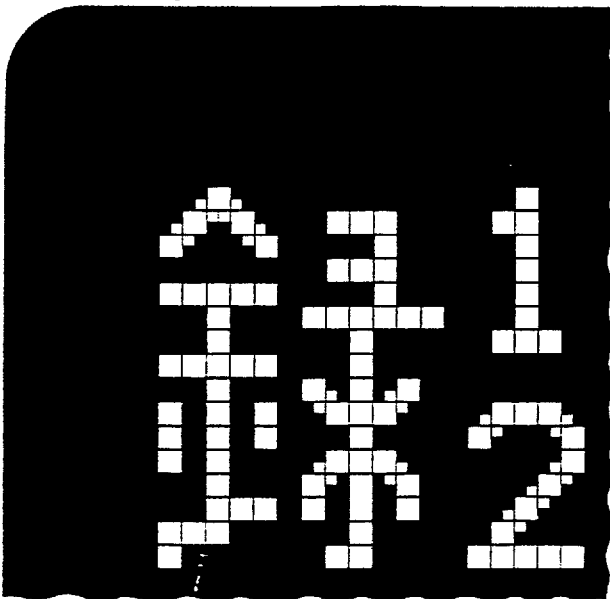

- Character color
- Background color

Entire Display On/Off

Part of the display can be turned off by setting blanking data or display off data. The entire display can be turned on or off with the display, smoothing, and/or write synchronous control commands. If display off is specified with the display on/off command, no characters or background are output.

Smoothing Function

In principle, this IC provide a display format of a 6-by-9 dot matrix. The SM bit of the display, smoothing, or write synchronous control command, however, activates the smoothing function. Where two dots meet only at the corners, as shown below, an extra dot is appended to give a resolution of 12 by 18 dots. The smoothing function is valid only for a specific character; it does not allow an extra dot to be appended between characters.

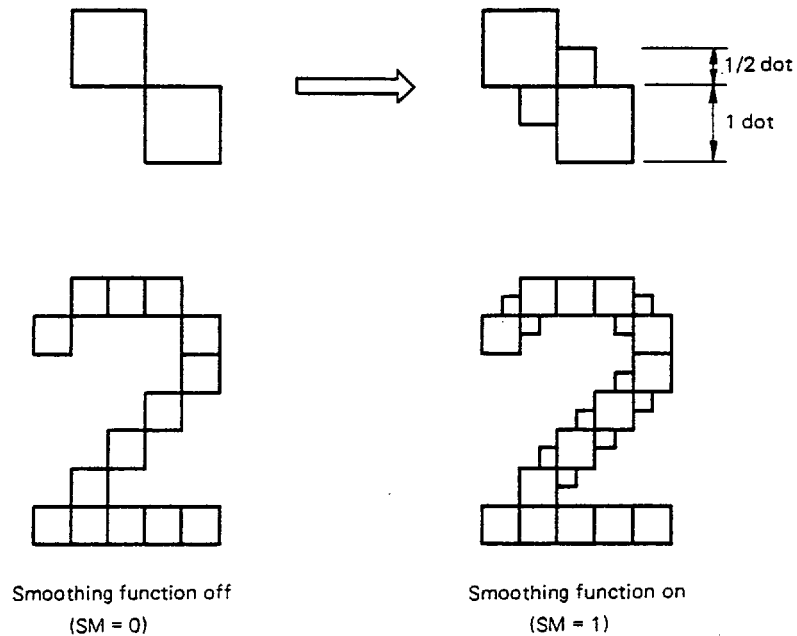

Write Synchronous Control

As described in the character display section, display character data can be written with just the display character data command after the initial write address has been set.

If characters are displayed on the screen via the display on/off control command bit, DO = 1, any write STB (strobe) signal subsequently input is implemented inside the IC in synchronization with $\overline{\text{HSYNC}}$, thus ensuring flickerless display even during data rewriting operations. Programming, therefore, should be carried out so that one or more $\overline{\text{HSYNC}}$ signals are generated between the rising edge of the STB signal for the preceding display data and the rising edge of the first clock of the next display data.

If no characters are displayed on the screen via the display on/off control command bit, DO = 0, or if display character data is written in asynchronously with $\overline{\text{HSYNC}}$ via the write synchronization/asynchronization select bit (DSYNC = 0), the display character data is written regardless of the $\overline{\text{HSYNC}}$ timing.

Display/smoothing/write synchronous control command

F0	D7	D6	D5	D4	D3	D2	D1	D0
0	1	1	1	0	0	D _{sync}	SM	DO

Display on/off control bits	
DO	Function
0	Display OFF
1	Display ON

Smoothing function control bits	
SM	Function
0	Smoothing function OFF
1	Smoothing function ON

Write synchronization/asynchronization select bits	
D _{sync}	Function
0	Writing of display character data asynchronously with $\overline{\text{HSYNC}}$
1	Writing of display character data in synchronization with $\overline{\text{HSYNC}}$

Identifies the display/smoothing/write synchronous control command

Mask Pulse Function (Mask Code Option)

When used in a VTR camera, the on-screen ICs provide two types of information: information to be recorded on VTR tape (such as date, time, picture titles, etc.), and information to be displayed only inside an electronic viewfinder (such as battery status, focus, sensitivity, and mode). To differentiate the two types of information, a mask option allows the V_R terminal (terminal No. 9) to be used as the character-by-character signal output terminal.

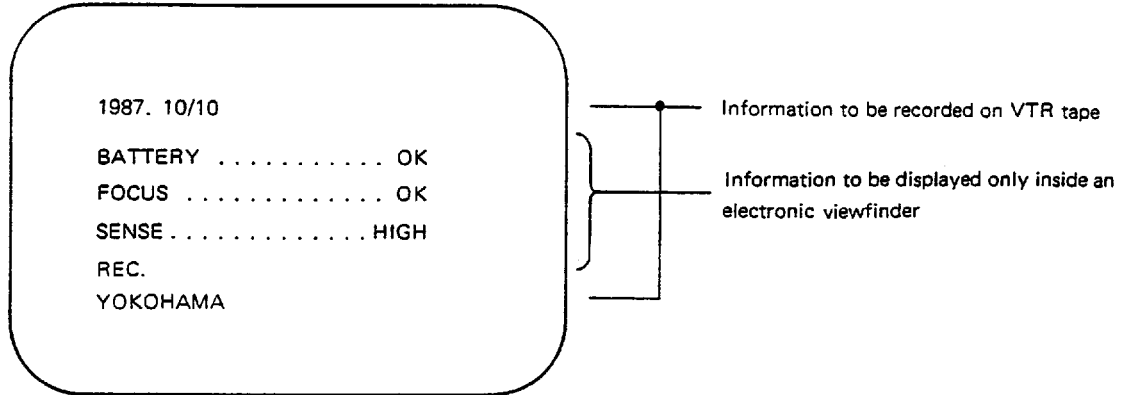

Example: The mask pulse is to be output to line addresses 1H, 3H, and 5H in a character size of 2H/dot

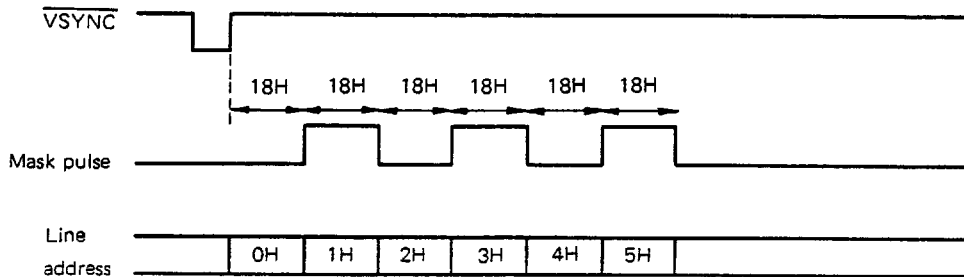

The leading and trailing edges of the mask pulse are synchronized with the trailing edge of \overline{HSYNC} .

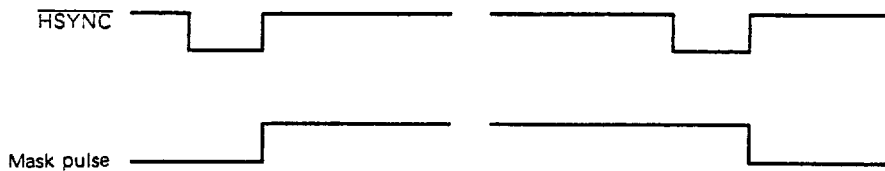

Mask pulse/character size specification command

(Available only when the mask pulse function is selected via a mask code option)

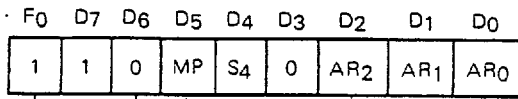

Line address selection bits			
AR2	AR1	AR0	Function
0	0	0	Selects the 1st line
0	0	1	Selects the 2nd line
1	0	1	Selects the 6th line

Do not set addresses other than 0 through 5.

Character size specification bits		
S4	Dot size of character	
0	Vertical 2H	Horizontal t_{dot}
1	Vertical 4H	Horizontal $2 \cdot t_{dot}$

$$t_{dot} = \frac{2}{f_{osc} \text{ (MHz)}} \mu\text{s}$$

Mask pulse specification bits	
MP	Function
0	Generates mask pulse
1	Does not generate mask pulse

Identifies the mask pulse/character size specification command

Adaptation to a Double-Speed Scan TV (via a Mask Code Option)

In general, if on-screen ICs are used in a television set with a double-speed scanning function, character output is doubled in width, halved in height, and halved in time lag (with respect to the vertical synchronization pulse) in comparison with conventional scanning in the NTSC and PAL systems. This is because the number of scan lines per field is twice, and the time required per horizontal scan is half, that of a conventional NTSC or PAL set. Although the character width can be adjusted according to the oscillation frequency (but the maximum permissible value of f_{osc} is 7.0 MHz), neither the character height nor the vertical position can be changed because they are automatically determined by the number of horizontal scan lines.

The μ PD6144 is therefore designed so that the character height and vertical position can be changed by inserting a single stage of 1/2-cycle dividers in the vertical address counter section using a mask code option. This, however, involves the following changes to the display-position vertical address assignment command and the character size specification command:

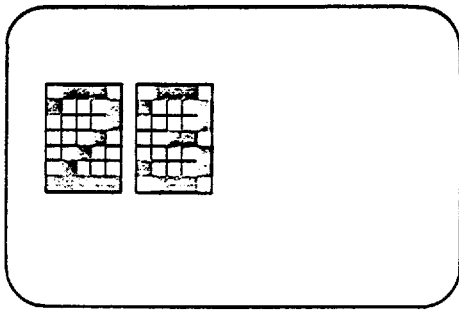

When an on-screen IC is used in a system with one field equivalent to 262.5 H (or 312.5 H)



www.DataSheet4U.com

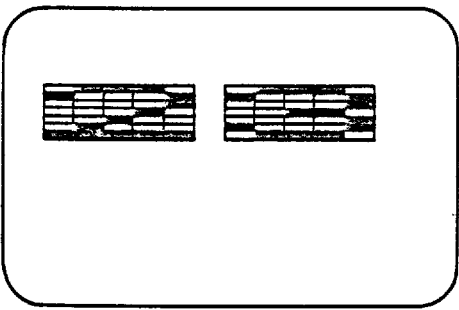

When an on-screen IC is used directly in a system with one field equivalent to 525 H (or 625 H)

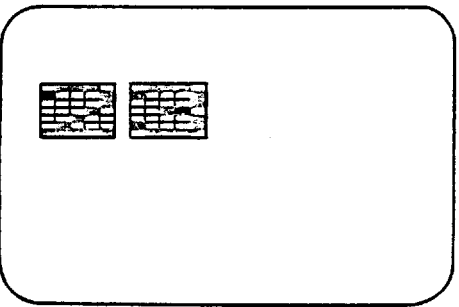

When an on-screen IC with its oscillation frequency doubled is used in a system with one field equivalent to 525 H (or 625 H)

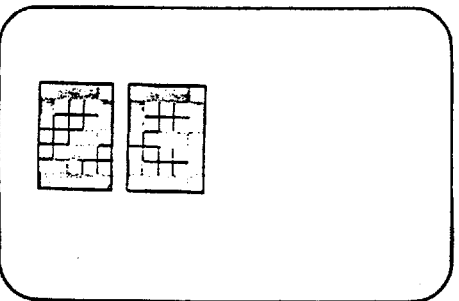
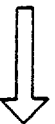

When a system with the μ PD6144C/G is assigned a double-speed scanning function by mounting a mask option

Display-position vertical address assignment command

(Available only when the system is assigned a double-speed scanning function by mounting of a mask code option)

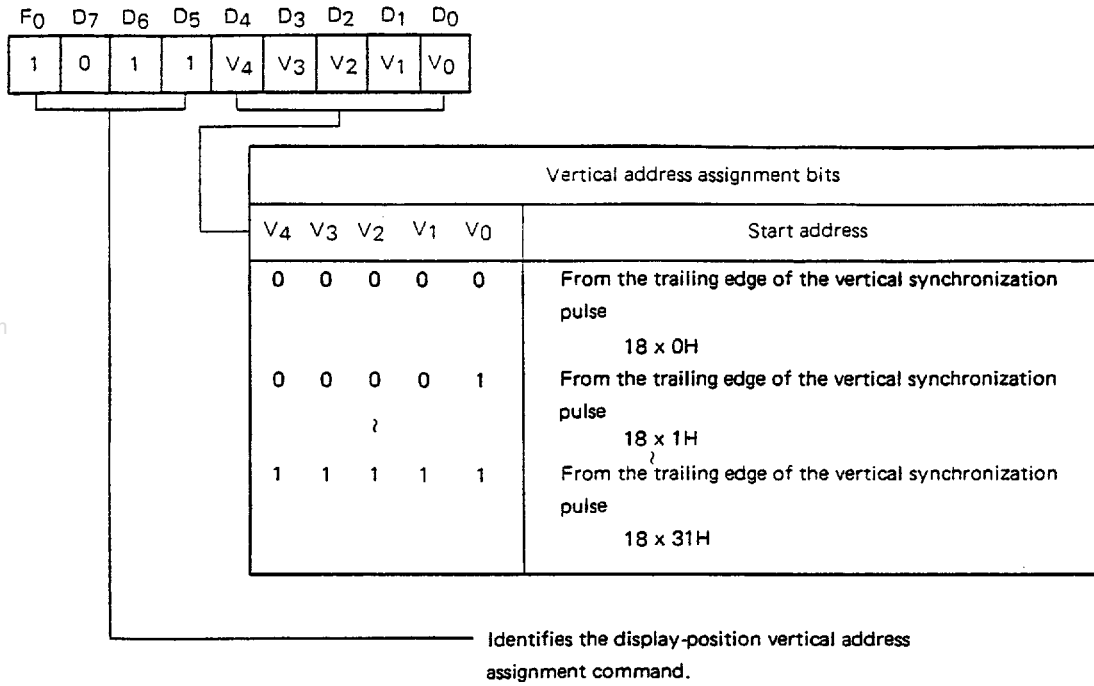

Note: The μ PD6144C-001 and μ PD6144G-101 ICs are not the products coded for the double-speed scanning function.

Character size specification command

(Available only when the system is assigned a double-speed scanning function by mounting of a mask code option)

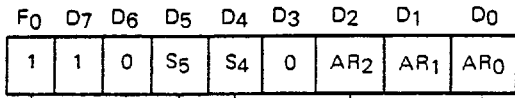

Line address selection bits			Function
AR ₂	AR ₁	AR ₀	
0	0	0	Selects the 1st line.
0	0	1	Selects the 2nd line.
1	0	1	Selects the 6th line.

Do not set addresses other than 0 through 5.

Character size specification bits		
S ₅	S ₄	Dot size of character
0	0	Vertical 4H Horizontal t_{dot}
0	1	Vertical 8H Horizontal $2 \cdot t_{dot}$
1	0	Vertical 12H Horizontal $3 \cdot t_{dot}$
1	1	Vertical 16H Horizontal $4 \cdot t_{dot}$

$$t_{dot} = \frac{2}{f_{osc} \text{ (MHz)}} \mu s$$

Identifies the character size specification command.

Conditions recommended for operation timing ($T_a = 25\text{ }^\circ\text{C}$, $V_{DD} - V_{SS} = 5.0\text{ V}$)

CHARACTERISTIC	SYMBOL	CONDITION	MIN.	TYPE	MAX.	UNIT
Minimum setup time	$t_{D\phi}$		200			ns
Minimum hold time	$t_{\phi D}$		200			ns
Minimum clock width at low level	$t_{\phi WL}$		700			ns
Minimum clock width at high level	$t_{\phi WH}$		700			ns
Minimum clock-to-strobe time	$t_{\phi S}$		400			ns
Minimum strobe width at high level	t_{SWH}		1			μs
Command execution delay time	t_{aCCS}		1			μs
Clock cycle	$t_{\phi CY}$		1.6			μs
Minimum strobe-to-clock time	$t_{S\phi}$	During display off	4			μs
Minimum $\overline{\text{VSYNC}}$ width at low level	t_{VWL}		4			μs
Minimum $\overline{\text{HSYNC}}$ width at low level	t_{HWL}		4			μs

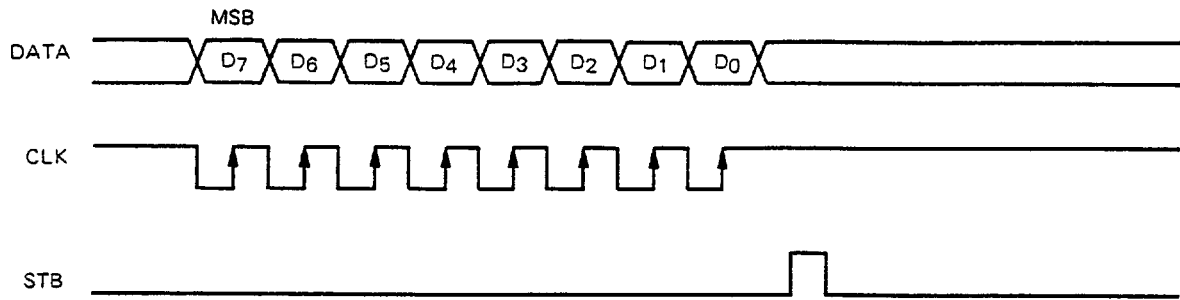

www.DataSheet4U.com

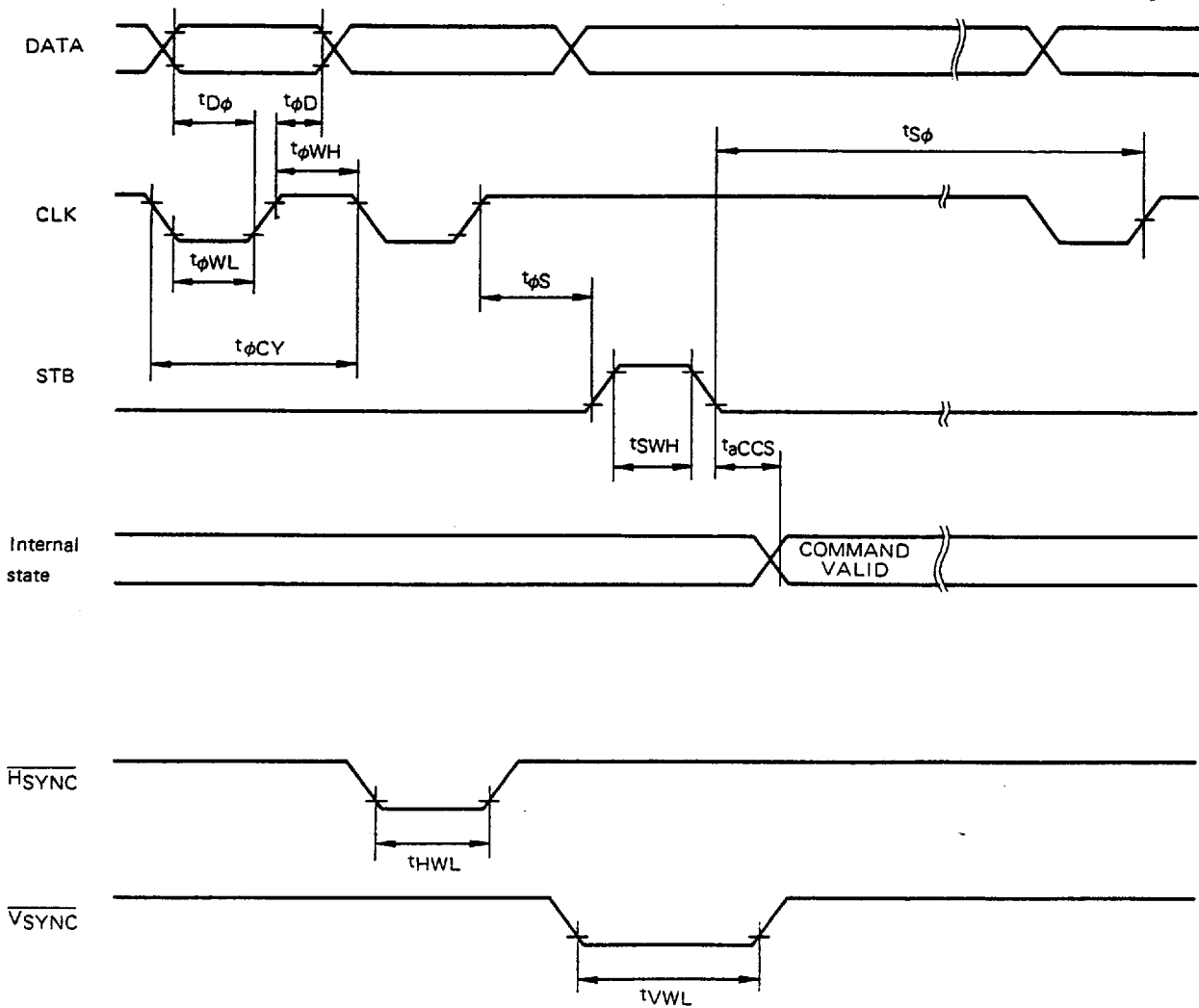

Note: When display character data is to be written in synchronization with $\overline{\text{HSYNC}}$ (i.e., when display on ($\text{DO} = 1$) is desired for $\text{D}_{\text{sync}} = 1$), carry out programming so that the following conditions are satisfied:

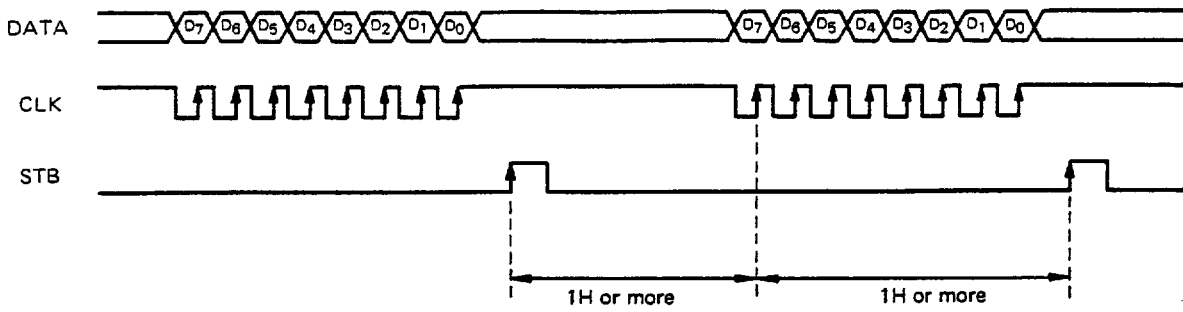

www.DataSheet4U.com

Application circuit configuration

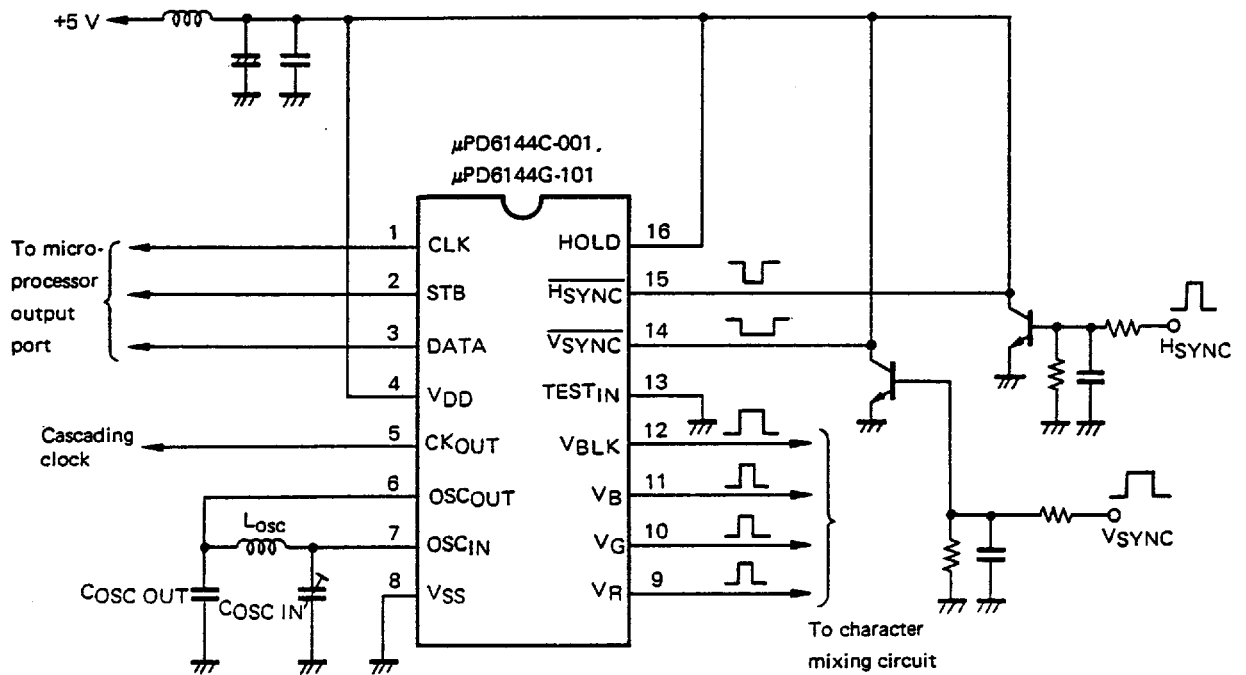

16-pin plastic DIP (300 mil)

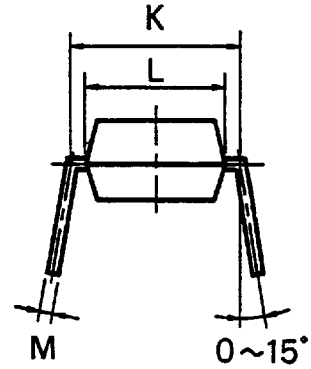
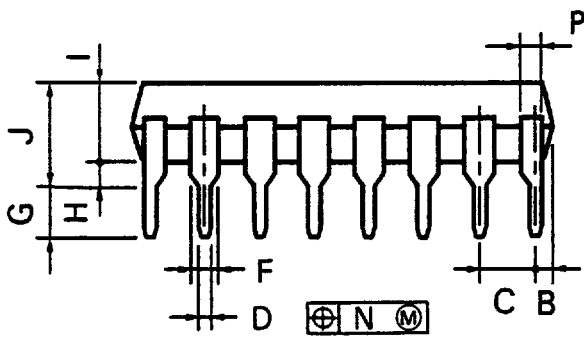
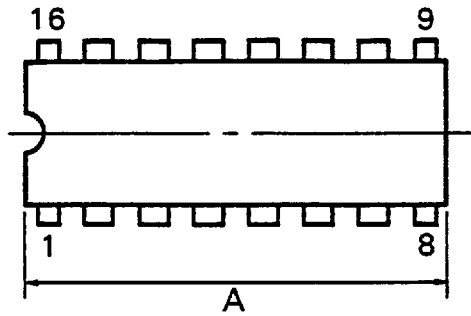

P16C-100-300B

NOTES

- 1) Each lead centerline is located within 0.25 mm (0.01 inch) of its true position (T.P.) at maximum material condition.
- 2) Item "K" to center of leads when formed parallel.

ITEM	MILLIMETERS	INCHES
A	20.32 MAX.	0.800 MAX.
B	1.27 MAX.	0.050 MAX.
C	2.54 (T.P.)	0.100 (T.P.)
D	0.50 ±0.10	0.020 ^{+0.004} / _{-0.003}
F	1.1 MIN.	0.043 MIN.
G	3.5 ±0.3	0.138 ±0.012
H	0.51 MIN.	0.020 MIN.
I	4.31 MAX.	0.170 MAX.
J	5.08 MAX.	0.200 MAX.
K	7.62 (T.P.)	0.300 (T.P.)
L	6.5	0.256
M	0.25 ^{+0.10} / _{-0.08}	0.010 ^{+0.004} / _{-0.003}
N	0.25	0.01
P	1.1 MIN.	0.043 MIN.

μPD6144G-101

16-pin plastic SOP (375 mil)

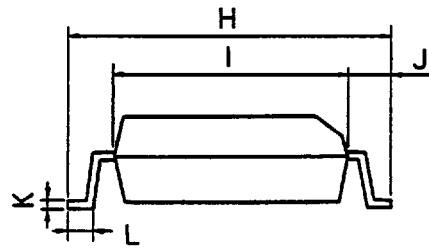
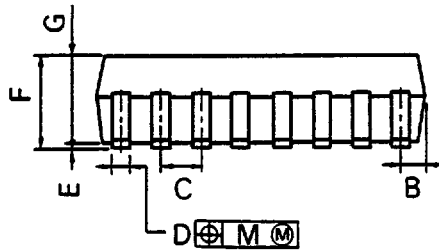
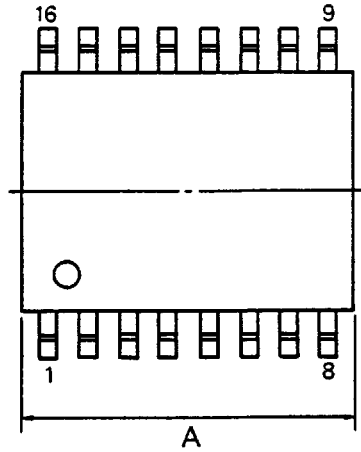

P16GM-50-375B

NOTE

Each lead centerline is located within 0.12 mm (0.005 inch) of its true position (T.P.) at maximum material condition.

ITEM	MILLIMETERS	INCHES
A	10.46 MAX.	0.412 MAX.
B	0.78 MAX.	0.031 MAX.
C	1.27 (T.P.)	0.050 (T.P.)
D	0.40 ^{+0.10} _{-0.05}	0.016 ^{+0.004} _{-0.003}
E	0.1 ^{+0.2} _{-0.1}	0.004 ^{+0.008} _{-0.004}
F	2.9 MAX.	0.115 MAX.
G	2.50	0.098
H	10.3 ^{+0.3}	0.406 ^{+0.012} _{-0.013}
I	7.2	0.283
J	1.6	0.063
K	0.15 ^{+0.10} _{-0.05}	0.006 ^{+0.004} _{-0.002}
L	0.8 ^{+0.2}	0.031 ^{+0.009} _{-0.008}
M	0.12	0.005