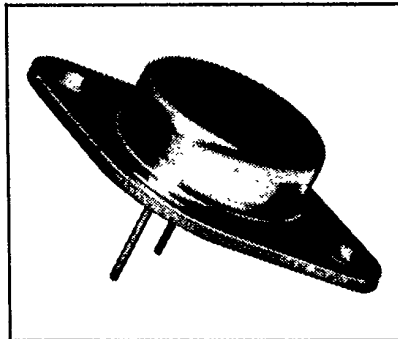
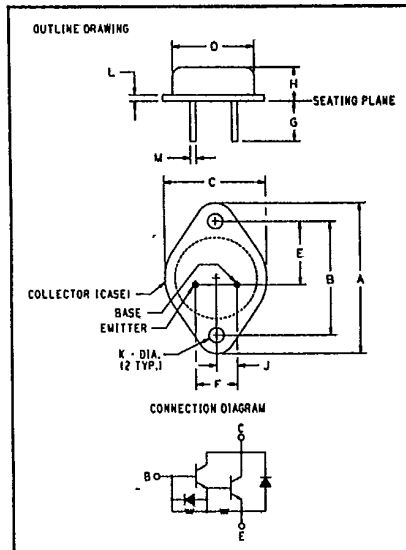

POWEREX**D64EV**

Powerex, Inc., Hillis Street, Youngwood, Pennsylvania 15697 (412) 925-7272

**Fast Switching
Single Darlington
Transistor Module****50 Amperes
500-600-700 Volts**

D64EV
**Fast Switching Single Darlington
Transistor Module**
50 Amperes/500-600-700 Volts

**500-600-700 Volts D64EV
Outline Drawing**

Dimension	Inches	Millimeters
A	1.573 Max.	39.96
B	1.187 ± .010	30 ± 0.15
C	1.050 Max.	26.68 Max.
D	.845 Dia.	21.47 Dia.
E	.662 ± .012	18.8 ± 0.3
F	.430 ± .005	11 ± 0.12
G	.426 Min.	10.82 Min.
H	.358 Max.	9.1 Max.
J	.215 ± .005	5.5 ± 0.12
K	.156 ± .006 Dia.	4 ± 0.15 Dia.
L	.065 Max.	1.65 Max.
M	.060 ± .003 Dia.	1.5 ± 0.08 Dia.

Description

Powerex Fast Switching Single Darlington Transistor Modules are designed for use in switching applications.

Features:

- High Speed
- High Gain (h_{FE})
- Base Emitter Speed-up Diode

Applications:

- UPS Inverters
- DC Motor Control
- Switching Power Supplies
- AC Motor Control
- HF Power Conversion

Ordering Information

Example: Select the complete six digit module part number for the rating you desire from the table - i.e. D64EV7 is a 700 Volt, 50 Ampere Fast Switching Single Darlington Module with speed-up diode.

Type	V _{CEV(SUS)} Volts (×100)	Current Rating Amperes (50)
D64EV	5	50
D64EV	6	50
D64EV	7	50



Powerex, Inc., Hillis Street, Youngwood, Pennsylvania 15697 (412) 925-7272

D64EV
Fast Switching Single Darlington Transistor Module
50 Amperes/500-800-700 Volts

Maximum Ratings $T_J = 25^\circ\text{C}$ unless otherwise specified

	Symbol	D64EV	Units
Junction Temperature	T_J	-65 to 150	$^\circ\text{C}$
Storage Temperature	T_{STG}	-65 to 150	$^\circ\text{C}$
Collector-Emitter Sustaining Voltage D64EV5	$V_{CE(SUS)}$	400	Volts
Collector-Base Voltage D64EV5	V_{CBO}	500	Volts
Collector-Emitter Sustaining Voltage D64EV6	$V_{CE(SUS)}$	450	Volts
Collector-Base Voltage D64EV6	V_{CBO}	600	Volts
Collector-Emitter Sustaining Voltage D64EV7	$V_{CE(SUS)}$	500	Volts
Collector-Base Voltage D64EV7	V_{CBO}	700	Volts
Emitter-Base Voltage	V_{EBO}	5	Volts
Continuous Collector Current	I_C	50	Amperes
Peak (Repetitive) Collector Current	I_{CM}	75	Amperes
Peak (Non-Repetitive) Collector Current	I_{CSM}	125	Amperes
Diode Forward Current	I_{FM}	50	Amperes
Continuous Base Current	I_B	10	Amperes
Peak (Non-Repetitive) Base Current	I_{BM}	20	Amperes
Power Dissipation	P_T	180	Watts

Electrical and Mechanical Characteristics $T_J = 25^\circ\text{C}$ unless otherwise specified

Characteristics	Symbol	Test Conditions	Min.	D64EV Typ.	Max.	Units
Collector Cutoff Current	I_{CEV}	$V_{CE} = V_{CE}(\text{rated}), V_{BE} = -1.5\text{V}$	—	—	1	mA
Collector Cutoff Current	I_{CEV}	$V_{CE} = V_{CE}(\text{rated}), V_{BE} = -1.5\text{V}$ $T_C = 150^\circ\text{C}$	—	—	2.5	mA
Emitter Cutoff Current	I_{EBO}	$V_{EB} = 1.5\text{V}$	—	—	350	mA
DC Current Gain	h_{FE}	$I_C = 75\text{A}, V_{CE} = 5.0\text{V}$ $I_C = 50\text{A}, V_{CE} = 5.0\text{V}$ $I_C = 20\text{A}, V_{CE} = 5.0\text{V}$	25 50 100	60 135 250	— — —	— — —
Collector-Emitter Saturation Voltage	$V_{CE(SAT)}$	$I_C = 75\text{A}, I_B = 5.0\text{A}$ $I_C = 50\text{A}, I_B = 4.0\text{A}$ $I_C = 20\text{A}, I_B = 2.0\text{A}$	— — —	2.2 1.7 1.15	3.0 2.0 1.5	V V V
Base-Emitter Saturation Voltage	$V_{BE(SAT)}$	$I_C = 75\text{A}, I_B = 5.0\text{A}$ $I_C = 50\text{A}, I_B = 4.0\text{A}$ $I_C = 20\text{A}, I_B = 2.0\text{A}$	— — —	2.8 2.45 1.95	3.5 3.0 2.5	V V V
Delay Time*	t_d	—	—	0.09	0.5	μs
Rise Time*	t_r	$V_{CC} = 250\text{V}, I_C = 50\text{A}$	—	0.5	1.0	μs
Storage Time*	t_s	$I_{B1} = 2.5\text{A}, -I_{B2} = 5\text{A}$	—	2.0	3.0	μs
Fall Time*	t_f	$t_p = 50 \mu\text{sec}$	—	.64	1.0	μs
Diode Power Dissipation	P_D	$I_{B1} = 0$	—	—	125	W
Diode Forward Voltage	V_{FM}	$I_{FM} = 25\text{A}$ $I_{FM} = 50\text{A}$ $I_{FM} = 50\text{A}, T_J = 150^\circ\text{C}$	— — —	1.95 2.6 2.3	3.20 3.80 3.50	V V V
Reverse Recovery Time	t_{rr}	$I_{FM} = 50\text{A}, di/dt = 25\text{A}/\mu\text{sec}$ $R_{B1E} = .25\Omega$	—	3.85	10.0	μs
Forward Turn-On Time	t_{ON}	$I_{FM} = 100\text{A}, di/dt = 100\text{A}/\mu\text{sec}$	—	0.75	1.5	μs
Thermal Resistance, Junction to Case	$R_{\theta JC}$	Transistor Part	—	—	.7	$^\circ\text{C}/\text{W}$
Thermal Resistance, Junction to Case	$R_{\theta JC}$	Diode Part	—	—	1.0	$^\circ\text{C}/\text{W}$
Max Lead Temp for Soldering	T_L	1/8" From case for 5 sec.	—	—	300	$^\circ\text{C}$

*Resistive Load.



Powerex, Inc., Hillis Street, Youngwood, Pennsylvania 15697 (412) 925-7272

D64EV
Fast Switching Single Darlington Transistor Module
 50 Amperes/500-600-700 Volts

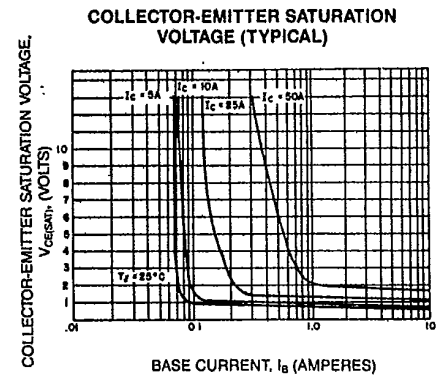
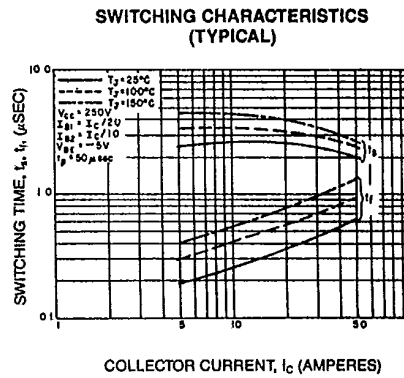
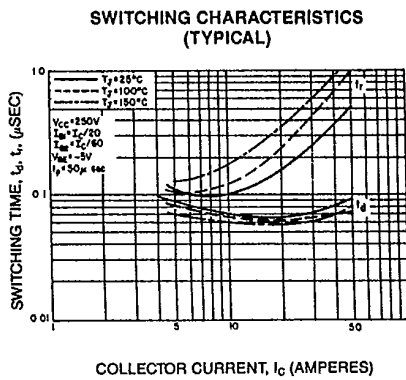
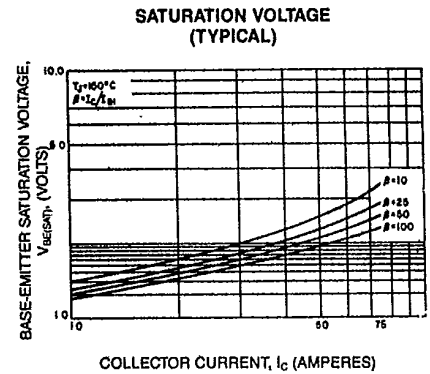
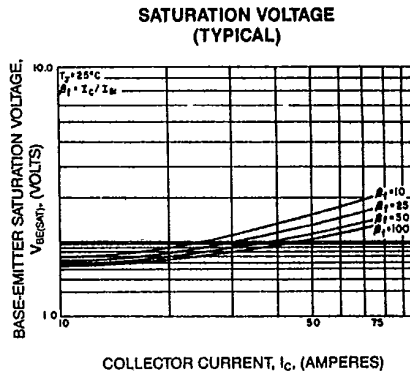
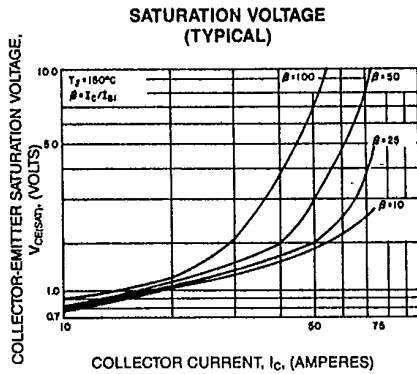
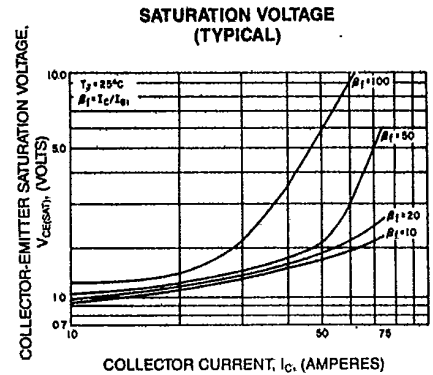
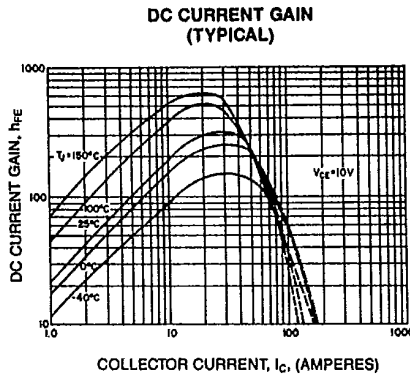
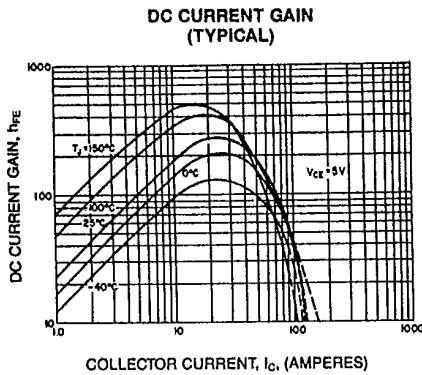



Powerex, Inc., Hillis Street, Youngwood, Pennsylvania 15697 (412) 925-7272

D64EV
Fast Switching Single Darlington Transistor Module
50 Amperes/500-600-700 Volts

SWITCHING TIME VS. BASE CURRENT (TYPICAL)

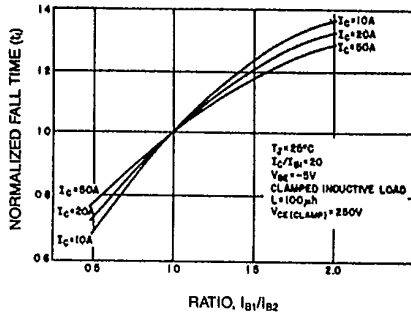

SWITCHING TIME VS. BASE CURRENT (TYPICAL)

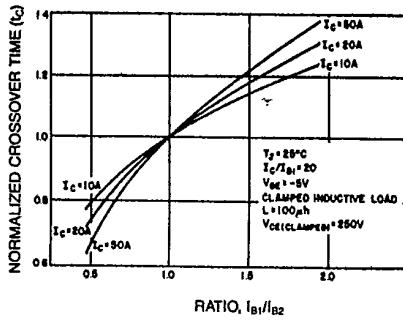

DIODE CHARACTERISTICS (TYPICAL)

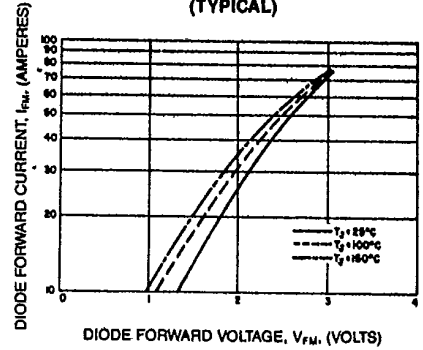

REVERSE BIAS SAFE OPERATING AREA (R.B.S.O.A.)

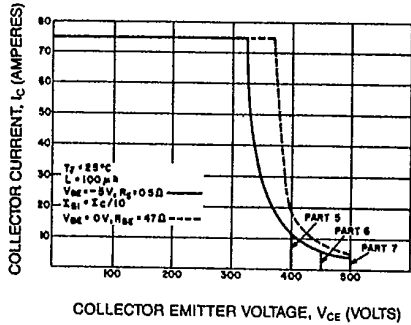

FORWARD BIAS SAFE OPERATING AREA (S.O.A.)

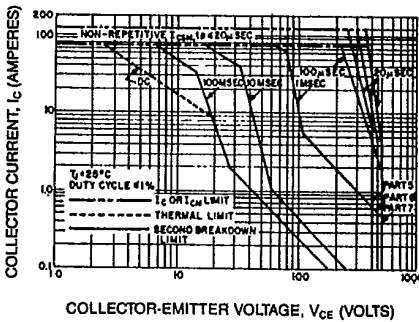

DERATING FACTOR OF SAFE OPERATING AREA (S.O.A.)

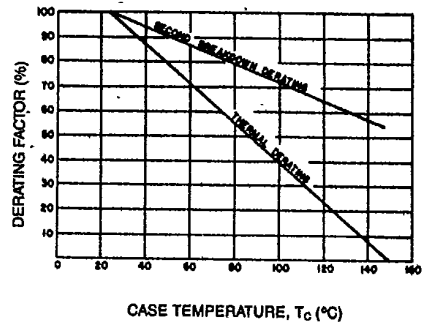

TRANSIENT THERMAL IMPEDANCE CHARACTERISTICS (TRANSISTOR)

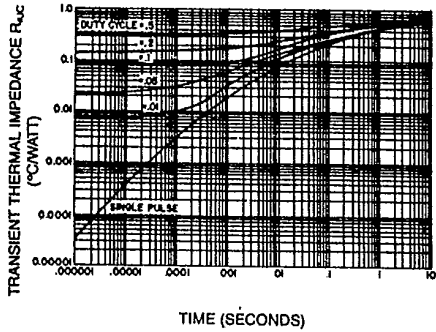

Switching Time Test Circuit

