



# D6571E

---

**EASYTAD<sup>®</sup> Chip for an All-Digital  
Telephone Answering Machine  
with Flash Memory Interface**

**TABLE OF CONTENTS:**

**GENERAL DESCRIPTION.....5**

    FEATURES ..... 5

    CHIP CONFIGURATION..... 6

    ADDITIONAL SYSTEM COMPONENTS (supplied by the customer according to DSP Group' s specifications)..... 6

    PIN DESCRIPTIONS..... 7

**FUNCTIONAL DESCRIPTION.....9**

    HOST Interface..... 9

    Voice Message Recording Incoming and Outgoing Messages ..... 9

    Digital Voice-Activated Recording (VOX)..... 9

    Automatic Gain Control..... 9

    Message Playback..... 9

    Offset and FLEXISPEECH™ ..... 9

    Message Deletion..... 10

    Message Time Stamp ..... 10

    Volume Control..... 10

    Tone Generation..... 10

    DTMF Detection..... 10

    Call Progress Tone (CPT) Detection..... 10

    Caller Identification (CID and CWCID) ..... 10

    Caller Alert Signal (CAS) Detection ..... 10

    Sensitivity Control..... 10

    Speed Dial Telephone Number Storage..... 10

    Non-Erasable Storage..... 10

    General Purpose Storage..... 10

    Self Test and Initialization ..... 11

    Reports ..... 11

    Voice Prompt Generation..... 11

    Near End Echo Cancellation..... 11

    Full Duplex Digital SpeakerPhone ..... 11

    Power Down Mode ..... 11

**OPERATIONAL DESCRIPTION .....12**

    INITIAL PROCEDURE..... 12

    MODES OF OPERATION ..... 12

    DESCRIPTION OF MODES OF OPERATION..... 13

        Idle..... 13

        Record ..... 13

        Playback..... 14

        Read Memory Status ..... 15

        Telephone Number Storage..... 16

        Non-Erasable Storage..... 16

        General Purpose Storage (GPS)..... 16

        Tone Generation Mode ..... 16

        New Tone Definition..... 17

        FSK Modem..... 17

        Line Monitoring Mode ..... 17

        CID Submode..... 18

        Delete Message ..... 18

        Set/Modify Time Stamp ..... 19

        Get Time Stamp ..... 19

        Get Available Record Time ..... 19

## D6571E Data Sheet

Self Test and Initialization.....	19
Voice Prompt Generation.....	22
Program Voice Prompt .....	23
Full Duplex SpeakerPhone Operation.....	24
Re-Compression Mode.....	27
<b>HOST INTERFACE PERFORMANCE.....</b>	<b>28</b>
<b>Power Down Operation.....</b>	<b>30</b>
<b>COMMAND SET .....</b>	<b>29</b>
0. IDLE .....	29
1. RECORD.....	29
2. PLAYBACK.....	33
3. READ MEMORY STATUS.....	35
4. WRITE TELEPHONE NUMBER.....	37
5. READ TELEPHONE NUMBER.....	40
6. TONE GENERATION.....	42
NEW TONE INITIALIZATION.....	44
FSK Modem.....	45
7. LINE MONITOR.....	51
8. DELETE MESSAGE.....	52
9. SET/MODIFY TIME STAMP .....	53
10. GET TIME STAMP.....	53
11. GET AVAILABLE RECORD TIME .....	55
12. SELF TEST AND INITIALIZATION.....	55
13. VOICE PROMPT PLAYBACK.....	71
PROGRAM VOICE PROMPT.....	72
14. SPEAKER PHONE.....	74
16. Re-Compress Message .....	82
<b>FUNCTIONAL BLOCKS.....</b>	<b>84</b>
DSP CORE.....	84
ADDRESS MUX.....	84
FLASHMEMORY INTERFACE.....	84
CLOCK GENERATOR.....	84
$\mu$ -law/A-law ENCODER.....	84
CODEC INTERFACE.....	84
I/O ADDRESS DECODER.....	84
HOST D6571E COMMUNICATION INTERFACE .....	83
<b>DATA TRANSFER MODES .....</b>	<b>86</b>
FUNCTIONAL DESCRIPTION.....	86
OPERATIONAL DESCRIPTION .....	86
<b>COMMAND SET FOR DATA TRANSFER MODES .....</b>	<b>92</b>
1. DATA PUMP FROM CODEC TO HOST (Record from Codec to Host).....	92
2. DATA PUMP FROM HOST TO CODEC (Playback from Host to Codec).....	95
3. DATA STORAGE (From Host to Flash).....	98
4. DATA RETRIEVAL (From Flash to Host).....	100
5. DATA COMPRESSION (From Host to Host).....	102
6. DATA DECOMPRESSION (From Host to Host).....	104
<b>APPLICATION HINTS .....</b>	<b>106</b>
<b>ELECTRICAL CHARACTERISTICS.....</b>	<b>106</b>

## D6571E Data Sheet

5 V OPERATION.....	106
3.3 V OPERATION.....	107
<b>DETECTORS CHARACTERISTICS .....</b>	<b>109</b>
DTMF & VOX CHARACTERISTICS.....	109
Call Progress Tone Detector Performance.....	109
Caller ID FSK Demodulator Performance .....	109
Caller Alert Signal / Idle State Tone Alert Signal.....	110



# D6571E

## EASYTAD<sup>®</sup> Chip for an All-Digital Telephone Answering Machine with Flash Memory Interface

### GENERAL DESCRIPTION

The D6571E chip is a digital speech/signal processing subsystem that implements all functions of TRUESPEECH<sup>®</sup> speech compression and voice prompts, telephone line signal processing, flash memory management and True FULL Duplex SpeakerPhone<sup>™</sup> for an all digital answering machine. The D6571E is fully controlled by the system HOST through a simple interface protocol. The HOST processor provides activation and control of all system functions such as speech recording and playback, DTMF and call progress tone detection, DTMF and tone generation, and voice prompting.

The fully digital solution has no moving parts, yielding high reliability. The chip's programmability enables a full range of answering, recording and playback features for the end user. The D6571E is a single-chip, digital signal processor that includes all of the necessary circuitry to interface with an external HOST, flash memory, and codec.

### FEATURES

- Superior quality TRUESPEECH<sup>®</sup> Triple Rate Coder<sup>™</sup> allowing selectable 11, 15 or 25 minutes of recording time per each 4 Mbit Flash Memory
- PCM Recording
- Flexible storage of incoming messages (ICM), outgoing messages (OGM). Supports multiple OGMs and multiple mailboxes.
- TRUESPEECH<sup>®</sup>, natural-sound voice prompting, for Day/Time stamp and voice instructions
- FLEXISPEECH<sup>™</sup> variable speed, natural sound playback (50% - 200%)
- DTMF generation and detection with near-end echo cancellation for superior performance
- Extended DTMF detection (A, B, C, D)
- Automatic Gain Control
- True FULL Duplex SpeakerPhone<sup>™</sup> with both acoustical and near-end echo cancellation
- Caller ID and Call Waiting CID demodulation (both Bell 202 and V.23)
- FSK modem for CID and  $\alpha$ -5 support
- Supports 4 Mb or 16 Mb Flash Memory Devices
- Supports Time Stamp (message tag) modification
- Programmable DTMF, CPT, VOX, CAS, and FSK Detectors Sensitivity
- Digital Volume Control
- $\mu$ -law and A-law codec support, selectable Master and Slave mode, selectable sampling rate.
- General Purpose (CID) and Non-Erasable Storages

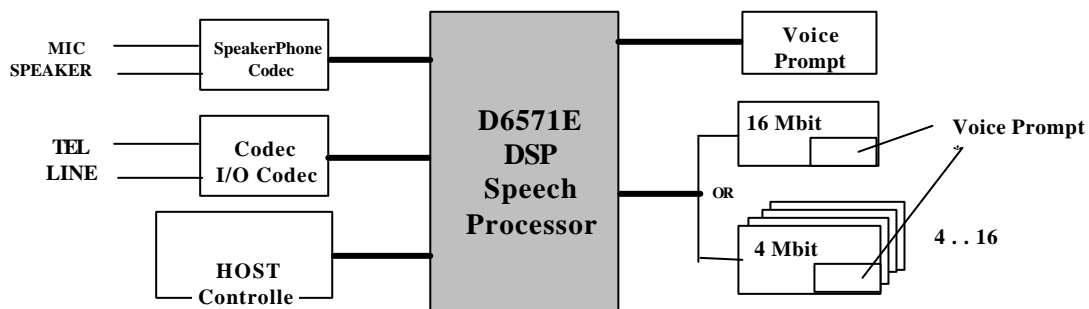

**Figure 1. D6571E Block Diagram**

\* Dashed lines indicate optional implementation  
 \*\* Only supported with single 4Mbit Flash or no

*All specifications are subject to change without prior notice*

# D6571E Data Sheet

## CHIP CONFIGURATION

- D6571E-11 Digital Telephone Answering Device (TAD) processor (80-pin PQFP) - 1 each

## ADDITIONAL SYSTEM COMPONENTS (supplied by the customer according to DSP Group's specifications)

- D0000-29 -  $\mu$ -law or A-law 8 bit serial codec - 1, 2 - for SpeakerPhone

### One of the following:

- Samsung KM29N040 (44-pin TSOP II) - 4 Mb, up to two devices per system (may have up to 3 bad blocks)
- Samsung KM29N1600 (44-pin TSOP II) - 16 Mb, single device (may have up to 10 bad blocks)
- Toshiba TC58A040F - 4 Mb, up to two devices per system (may have up to 10 bad blocks)

\* Optionally, the system will support up to 64K EPROM/ROM (access time 300 ms or less) for Voice Prompt storage. This option is only available in systems with a single 4Mbit flash memory device or no flash in the system.

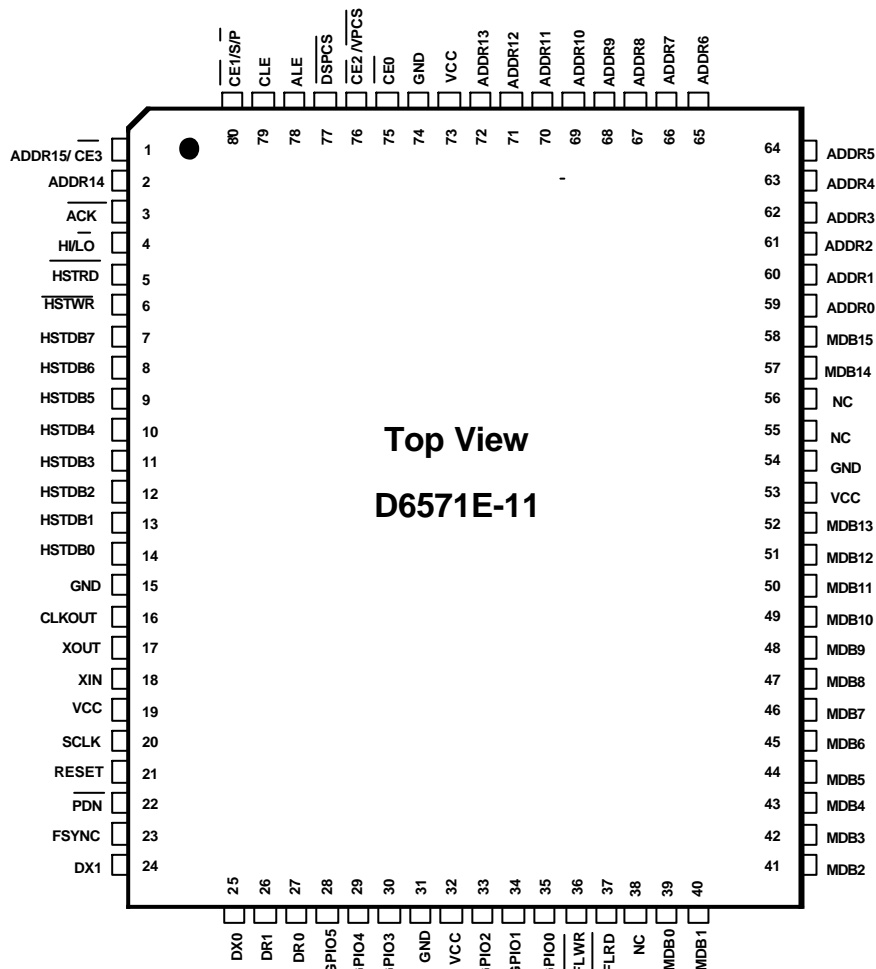

Figure 2. D6571E-11 Pin Diagram

## D6571E Data Sheet

### PIN DESCRIPTIONS

D6571E-11 (DSP)			
PIN			
Name	No.	I/O/Z	Description
HSTDB0 (LSB)	14	I/O/Z	HOST DATA BUS. The HOST writes commands and reads status to/from the D6571E via this bus. The HI/ $\overline{LO}$ pin selects between the low byte and the high byte of the command/status. This bus is used for input when $\overline{HSTWR}$ is low, and for output when $\overline{HSTRD}$ is low. It has high impedance when $\overline{HSTWR}$ and $\overline{HSTRD}$ are high or RESET is high.
HSTDB1	13	I/O/Z	
HSTDB2	12	I/O/Z	
HSTDB3	11	I/O/Z	
HSTDB4	10	I/O/Z	
HSTDB5	9	I/O/Z	
HSTDB6	8	I/O/Z	
HSTDB7 (MSB)	7	I/O/Z	Active only during Host Read.
HI/ $\overline{LO}$	4	I	HIGH/LOW BYTE SELECT. When this signal is low, the HOST can read/write the low byte of the status/command. When high, the high byte is selected.
$\overline{HSTRD}$	5	I	HOST READ. When low, the HOST reads the low/high byte of the status word.
$\overline{HSTWR}$	6	I	HOST WRITE. When low the HOST writes commands to the D6571E via HSTDB 0-7.
ACK	3	O	HOST ACKNOWLEDGE. This pin goes low when the D6571E send a status word to the HOST. It goes high when the HOST reads the high byte of the status word.
$\overline{DSPCS}$	77	I	DSP Chip Select (Optional connection to ground recommended, if not used.)
ADDRO (LSB)	59	O	EXTERNAL MEMORY ADDRESS BUS
ADDR1	60	O	
ADDR2	61	O	
ADDR3	62	O	
ADDR4	63	O	
ADDR5	64	O	
ADDR6	65	O	
ADDR7	66	O	
ADDR8	67	O	
ADDR9	68	O	
ADDR10	69	O	
ADDR11	70	O	
ADDR12	71	O	
ADDR13	72	O	
ADDR14	2	O	
ADDR15 / $\overline{CE3}$	1	O	Chip Enable 3 for flash device or Address 15 for external 64K/ EPROM
$\overline{CE1}$	80	I/O	Chip Enable 1 for flash device
$\overline{CE0}$	75	O	Chip Enable 0 for flash device
CE2/VPCS	76	O	Chip Enable 2 for flash device or Voice Prompt ROM/EPROM Chip Enable
ALE/DI	78	O	Address Latch Enable for Samsung flash devices; Data Input for Toshiba device
CLE/DO	79	O	Command Latch Enable for Samsung flash devices; Data Output for Toshiba device
MDB0 (LSB)	39	I/O/Z	EXTERNAL MEMORY DATA BUS.
MDB1	40	I/O/Z	
MDB2	41	I/O/Z	
MDB3	42	I/O/Z	
MDB4	43	I/O/Z	
MDB5	44	I/O/Z	
MDB6	45	I/O/Z	
MDB7	46	I/O/Z	
MDB8	47	I/O/Z	
MDB9	48	I/O/Z	
MDB10	49	I/O/Z	
MDB11	50	I/O/Z	
MDB12	51	I/O/Z	

## D6571E Data Sheet

<b>D6571E-11 (DSP)</b>			
MDB13	52	I/O/Z	
MDB14	57	I/O/Z	
MDB15 (MSB)	58	I/O/Z	
$\overline{\text{FLRD}}$	37	O	Flash Read Enable
$\overline{\text{FLWR}}$	36	O	Flash Write Enable; Shift Clock for Toshiba flash
DR0	27	I	Serial input for CODEC0 PCM data
DX0	25	O	Serial output for CODEC0 PCM data
DR1	26	I	Serial input for CODEC1 PCM data
DX1	24	O	Serial output for CODEC1 PCM data
FSYNC	23	I/O	Frame synchronization signal for CODECs (input in slave mode)
SCLK	20	I/O	Shift Clock for CODECs (input in slave mode)
XIN	18	I	Crystal input pin for internal oscillator.
XOUT	17	O	Crystal output pin for internal oscillator.
GND	15	PWR	GROUND PIN
GND	31	PWR	GROUND PIN
GND	54	PWR	GROUND PIN
GND	74	PWR	GROUND PIN
V <sub>CC</sub>	19	PWR	
V <sub>CC</sub>	32	PWR	
V <sub>CC</sub>	73	PWR	
V <sub>CC</sub>	53	PWR	
$\overline{\text{PDN}}$	22	I	Power fail sensor input. When a low level is detected on this pin, the D6571E enters power-down mode.
RESET	21	I	Reset input
EGPIO5	28	I/O	General Purpose I/Os
EGPIO4	29	I/O	
EGPIO3	30	I/O	
EGPIO2	33	I/O	
EGPIO1	34	I/O	
EGPIO0	35	I/O	
CLKOUT	16	O	These pins should be left unconnected
NC	38	I	Optional, connection to ground recommended
NC	55	I	
NC	56	I	



## D6571E Data Sheet

### **FUNCTIONAL DESCRIPTION**

#### **HOST Interface**

The HOST interface is an 8-bit parallel data port, used for control and status information transfer. The HOST controls the operation of the D6571E using a simple command protocol. D6571E status information is updated after each command.

The command and status protocol enables the HOST to have full control over the functions of the D6571E. This protocol is described in details in the following sections.

#### **Voice Message Recording Incoming and Outgoing Messages**

The D6571E message storage utilizes a proprietary, high quality speech compression algorithm to reduce the data rate of the speech signal. The compression algorithm is programmable and can support different bit rates: high, middle, and low bit rate. Each of the rates can be activated with “gap coding.” When activated with no “gap coding” the D6571E provides 9.6, 7.2, and 4.4 Kbps respectively at 8 KHz sampling rate. At 7.2 KHz sampling rate bit rate will be 10% lower. When the compression algorithm utilizes both low bit rate and “gap coding”, the D6571E achieves a recording time of 22-25 minutes in a 4 Mbit device using a 8000 Hz sampling rate. At 7200 Hz sampling rate the D6571E provides 24 - 27 min of recording time. The chip can support up to four 4 Mbit devices or one 16 Mbit device.

The chipset supports up to 128 variable length incoming and outgoing messages. Multiple outgoing messages and multiple mailboxes for incoming messages are supported.

During recording, the D6571E performs telephone line signal monitoring. The HOST can stop recording and delete unwanted information (silence or telephone signaling) by performing a “Tail Cut”. The Host can delete the last n\*TCF seconds from the memory using a Record command with a Tail Cut Factor (TCF). Tail Cut Factor is 0.160 seconds for 8 KHz sampling rate and 0.176 seconds for 7.2 KHz. For PCM messages Tail Cut increment is 240 ms or 266 ms respectively.

A message with less than 1 second duration won't be stored in the message directory.

During record mode the HOST can instruct the D6571E to generate an audible tone to the telephone line. The recorded audio signal that is digitized through the CODEC input is transmitted back through the CODEC output for call screening and other features. This Loop-Back function can be disabled by the HOST in the Record command.

#### **Digital Voice-Activated Recording (VOX)**

Digital voice activity detection is implemented in the D6571E and can be activated only in Record mode. According to the HOST command recording of the speech signal may either start upon a positive result of voice activity detection or immediately after issuing a Record command.

The voice activity detector output is reported to the HOST via a status bit every frame when in Record mode. The HOST reads this information and decides when to stop recording of the message.

#### **Automatic Gain Control**

The D6571E supports AGC in Record mode. AGC can be enabled/disabled by the Host. Parameters of the AGC are Host programmable.

#### **Message Playback**

The D6571E supports random access for playback of any recorded message. During playback, the D6571E monitors the telephone line.

#### **Offset and FLEXISPEECH<sup>®</sup>**

Each message can be played from the beginning of the message or from any given offset point along the message (in 0.64 second increments). The HOST can also read during playback, the current offset position in order to implement jumps within the message. For PCM messages offset increment is 0.93 sec for 8 KHz sampling rate (1.03 sec for 7.2 KHz sampling rate). The D6571E also supports FLEXISPEECH<sup>™</sup>, variable speed playback, with a range of 0.5 to 2.0 relative to the original speed. The FLEXISPEECH<sup>™</sup> feature allows listening to messages at different speeds without changing the voice characteristics and without degradation of the voice quality.

Message playback can be stopped by using the Pause command, which is initiated by the HOST. After Pause,

## D6571E Data Sheet

playback may be resumed from the same point. Normally, during playback, the status word will contain information about the line signals and the playback status and will notify the HOST when the end of message is reached.

### Message Deletion

The D6571E allows selective deletion of any prerecorded message from memory. After each deletion the message directory is updated accordingly. Message deletion does not free the memory space. Memory is freed by using the "Garbage Collection" command.

### Message Time Stamp

The HOST may attach two 16-bit data words to each of the 128 messages of the D6571E. This data can be used for time/date stamping the recorded message and any other information defined by the Host. Time Stamp can be modified after message has been recorded.

### Volume Control

The D6571E allows control of the signal that is playing to the CODEC. This function affects the level of the played back signal in the Message Playback and Voice Prompt modes, as well as the level of the looped back signal in the Record and Line Monitor modes.

### Tone Generation

Single and double tone signals can be generated by D6571E. There are 32 locations provided in the tone table. No Tone and 12 standard DTMF tones are predefined and other telephony tones may be added to the table one time. The HOST can program tones into any of the 19 remaining entries in this table. The levels and frequencies are programmable and controlled by HOST. During tone generation the D6571E monitors the line.

In case of "cold start" the D6571E can generate No Tone and 16 preprogrammed standard DTMF tones. See mode description for details.

### DTMF Detection

DTMF detection is implemented by the D6571E in software. This function may be used for remote operation of the answering device. The identification

code of detected DTMF signals is transmitted to the HOST for further processing. Host selects whether the D6571E reports detection of the 12 DTMF tones or 16 DTMF tones.

### Call Progress Tone (CPT) Detection

The D6571E monitors the line for incoming telephone line signals and detects the presence of call progress tones in a predefined frequency region. The D6571E supports call progress tone detection by utilizing a filter/detector with a bandwidth of 300-640 Hz. Indication of the presence of call progress tones is transferred to the HOST, and may be used for terminating recording.

### Caller Identification (CID and CWCID)

The D6571E can monitor and demodulate the FSK signals that provide CID information from the Central Office (CO). Both Bell 202 and V.23 demodulation is supported and the D6571E will automatically adapt to the FSK modulation provided from the CO.

### Caller Alert Signal (CAS) Detection

The D6571E supports detection of the Caller Alert Signal (CAS) in all functional modes for Call Waiting CID support. The same signal known as Idle State Tone Alert Signal is a part of the V.23 protocol.

### Sensitivity Control

The D6571E allows independent control of the sensitivity of the VOX, DTMF, and Call Progress Tone (CPT), and CAS detectors.

### Speed Dial Telephone Number Storage

The D6571E may store up to 128 telephone numbers, each with up to 16 digits for dialing. The 1024 bytes of memory can also be used for any other purpose by the HOST.

### Non-Erasable Storage

The D6571E supports 1600 bytes of a non-erasable storage.

### General Purpose Storage

The D6571E supports up to 16 sectors of a General Purpose Storage. Each sector allows 3200 bytes of storage.

## D6571E Data Sheet

### Self Test and Initialization

The D6571E supports various functions responsible for testing and initialization of the Flash memory, codec interfaces, detectors, and other system configurations.

### Reports

The D6571E is capable of reporting to the HOST the status of the currently available Flash memory storage space, as well as the overall status of the Flash memory and the number of recorded messages.

### Voice Prompt Generation

The D6571E implements high-quality Voice Prompt playback, utilizing the built-in speech decoder. Some portion of the Flash memory or an external ROM can store the vocabulary. The D6571E supports up to four 64K byte sectors of voice prompts in flash memory or one 64K byte external ROM or EPROM. Each 64K voice prompt sector supports up to 128 phrases or utterances. The D6571E receives the voice prompt sector number (if more than one is used) and the phrase number from the HOST, as part of the Voice Prompt command, and outputs the appropriate speech segment via the CODEC interface. The gap between two consecutive phrases is controlled by the HOST and can be as low as 0. During playback of the Voice Prompts, the D6571E monitors the telephone line.

The configuration with external Voice Prompt ROM is available if only one 4M flash or no flash is installed.

The Voice Prompts for the Flash memory may be built with a Voice Prompt Workstation, which is available through the DSP Group, Inc.

### Near End Echo Cancellation

A near-end echo canceller is activated during Playback, Tone Generation, and Voice Prompt Generation modes. This echo canceller enhances the performance of the DTMF and Call Progress Tone detectors in the presence of near end echo from the hybrid.

### Full Duplex Digital SpeakerPhone

The D6571E implements a True Full Duplex Digital SpeakerPhone mode. In this mode the D6571E provides adaptive acoustical echo cancellation between the speaker and microphone connection as well as adaptive

near-end echo cancellation to the telephone line connection. While in SpeakerPhone mode, the D6571E can generate tones from the tone table and monitor line for presence of DTMF, CPT, and CAS signals.

Unlike most SpeakerPhone implementations, the D6571E implements a **Full Duplex SpeakerPhone**. In most speakerphones, only one party can speak at the same time, the other party is always muted, sometimes by as much as 50 dB. This is Half Duplex SpeakerPhone operation.

The D6571E allows true **Full Duplex SpeakerPhone** operation. This implementation allows both parties to speak at once and be heard by the party at the opposite end of the call. The D6571E allows Full Duplex SpeakerPhone operation due to the highly efficient adaptive echo cancellation on both the acoustical and electrical sides.

The D6571E supports DTMF, CAS, and CPT detection during SpeakerPhone mode thus enabling such functions as CID on Call Waiting, auto redial, and less cost routing.

### Power Down Mode

The D6571E will go into stop mode during power failure. No battery backup is required to retain data in the case of power failure.

## D6571E Data Sheet

### OPERATIONAL DESCRIPTION

#### INITIAL PROCEDURE

**No operation should be performed with the new flash before it is initialized once. Any flash access before initialization may destroy information about bad blocks and make flash unusable.**

After power up, the  $\overline{\text{PDN}}$  signal (pin 22) should be set high followed by the RESET pulse (Refer to Figure 4 for the timing). Upon detecting falling edge of the RESET pulse, the D6571E checks some predefined locations in the Flash Memory to determine if Flash was initialized and responds to one of the following situations:

1. Flash memory was previously initialized - "warm start". The D6571E restores the previous conditions and system parameters. The message directory and all messages remain saved. The D6571E returns garbage collection status with the "cold start" bit reset (0).
2. Flash memory was not previously initialized - "cold start". The D6571E returns garbage collection status with the "cold start" bit set (1).

**After sending Garbage Collection status the D6571E will enter Idle mode. After sending RESET the Host should wait for ACK pin to become low and then read status. No command should be sent to the D6571E until host reads the Garbage Collection Status.**

If this is a "cold start" only commands that do not require flash access are available: Idle, Line Monitor, Read Memory Status, SpeakerPhone, Tone Generation (16 standard DTMF tones only), Data Pump, and Self Test and Initialization. If any other command is issued, the D6571E will stay in Idle mode and return Idle status.

The D6571E behaves in the same manner if the flash is not initialized ("cold start" condition) or there is no flash in the system ("no flash" condition).

To initialize flash memory Flash Hardware Selection (Test Mode = 0101) be issued first because no other Self Test and Initialization command will be accepted until this command is issued! After Flash Hardware Selection only Test Mode = 0011 (Fast Self Test) and Test Mode = 0001 (Flash Initialization) are available.

The Flash Hardware Selection and the Fast Self Test command can be issued to confirm the configuration of the flash if necessary. Fast Test will destroy the

contents of the memory except for the voice prompt sectors, tone table, and bad block table.

Normally the Flash Hardware Selection and then the Flash Initialization command may be sent to perform the Initialization. All memory will be initialized except for the voice prompt sectors and bad block table.

#### MODES OF OPERATION

The D6571E is normally in Idle mode. Each time a command other than Idle is issued, the system will enter the new mode. From some of the modes, the system will automatically return to Idle mode after completion of the operation. Other modes (Record, Playback, Tone Generation, Line Monitoring, Voice Prompt Generation and SpeakerPhone) require an Idle command to return to Idle mode.

There are 16 modes of operation. Each of these modes is entered from the monitor program through Idle mode. The 16 modes are as follows:

0. **Idle** - The D6571E performs command polling. It checks the command register in the HOST-D6571E interface and transfers to the requested operating mode.
1. **Record** - The D6571E performs speech compression and records a message into the Flash memory.\*
2. **Playback** - The D6571E performs message playback using compressed speech data stored in the Flash memory.\*
3. **Read Memory Status** - The D6571E returns information on the Memory status to the HOST, e.g., the number of messages stored in the Flash memory, memory full condition, program ROM checksum status, voice prompt checksum status and if Garbage collection is recommended.
4. **Write Data to Storage** - In this mode the D6571E receives data from the HOST and stores it either in the Telephone Number Storage, or Non-Erasable Storage, or General Purpose Storage in the flash under index number given by the HOST.
5. **Read Data from Storage** - The D6571E returns to the HOST data stored in Telephone Number Storage, or Non-Erasable Storage, or General Purpose Storage under the index number given by the HOST.
6. **Tone Generation** - The D6571E generates a single or double tone with programmable parameters. \*

## D6571E Data Sheet

FSK modem is supported as a submode of the Tone Generation mode

7. **Line Monitoring** - The D6571E monitors the telephone line for the presence of DTMF signals, Call Progress Tones, CAS, and CID signals.\*
8. **Delete Message** - The D6571E can erase any selected Flash memory message entry whose number is specified by the HOST from the message directory. The D6571E is able to perform Garbage Collection to free memory space by erasing sectors.
9. **Set Current Time** - The HOST sends the D6571E the current time & date stamp and/or status information to be attached to the next recorded message.
10. **Get Time Stamp** - The D6571E returns to the HOST the time & date stamp and/or any other information associated with a specific Flash memory message.
11. **Get Available Record Time** - The D6571E reports the currently available Flash memory record time.
12. **Self Test & Initialize Memory** - The D6571E performs Flash memory testing and mapping as well as other initialization functions.
13. **Voice Prompt Generation** - The D6571E implements a TRUESPEECH™ Voice Prompt playback from Flash memory or the external ROM/EPROM. The D6571E implements voice prompt programming into Flash memory. \*
14. **SpeakerPhone** - The D6571E implements a True Full-Duplex SpeakerPhone algorithm. \*
15. **Re-Compression** -- re-compresses recorded messages to another compression rate.
16. **Data Transfer Modes** - The D6571E implements various modes, which involve transmit/receive voice data via HOST Data bus. These modes are described in separate section "Data Transfer Modes".

\*These modes require an Idle command to return to Idle mode.

### DESCRIPTION OF MODES OF OPERATION

#### Idle

This is polling mode in which the D6571E monitors the D6571E-HOST interface for HOST commands. Transition to any other mode must always be done through the Idle mode.

#### Record

When the HOST sends a Record command, the D6571E performs speech compression and stores the message in the Flash memory. If bit 6 (VOX) in the first Record command is "0", the D6571E starts recording immediately after receiving the Record command. If VOX bit is set to "1", the D6571E starts recording after detecting voice activity.

The TRUESPEECH compression algorithm, implemented in the D6571E is HOST programmable and is able to utilize three compression rates as well as "gap coding". Record mode (bits 7-9 of the first Record command) are defined as follows:

- 000 - low bit rate
- 001 - middle bit rate
- 010 - high bit rate
- 011 - reserved
- 100 - PCM ( $\mu$ -law or A-law)

When bit GAP (bit 4) is set to "1" gap coding will be activated with any of the compression rate (gap coding is not available in case of PCM recording).

The compression algorithm is defined by the first Record command. It can be changed while in Record mode.

While in this mode, the D6571E monitors the communication port every frame for HOST commands. If no new command is detected, the D6571E continues recording. While in Record Mode, the D6571E monitors the line. If an additional Record command is detected, the D6571E returns the status word with VOX status (bit 6), memory status (bit 7), index of the DTMF and CAS signal detected (bits 03, 5), and Call Progress Tone presence (bit 4) to the HOST. See Line Monitor mode for the respective indexes for DTMF tones. While in Record mode, the Host may issue a Command to change independently the DTMF, VOX, CPT, and CAS Sensitivity or the Volume of the looped back signal without interrupting this mode. The status word will reflect the status for the Record mode. Therefore, line monitoring will not be affected.

If an Idle command is detected, the D6571E stops recording, updates the message directory, and returns to Idle mode. The D6571E reports to the HOST by

## D6571E Data Sheet

sending the Idle mode status word. The D6571E assigns the next available message number to a newly recorded message. The first message will be assigned the number "0", the second message will be assigned the number "1", and so on, up to "127".

Record mode can be terminated by sending a Record command with non-zero "Tail Cut" factor (TCF). The D6571E stops recording and automatically deletes the last n\*TCF seconds from memory. The value of the TCF is 0.160 seconds for 8000 Hz sampling rate and 0.178 seconds for 7200 Hz sampling rate. The D6571E then returns to Idle mode. For PCM recording the value of the TCF is 0.240 seconds and 0.266 seconds for 8 KHz and 7.2 KHz sampling rate respectively.

Host can pause recording by sending Record command with REC MODE = 10. The D6571E will stay in Record mode, monitor line but won't store data into flash. The Host can send Record command with REC MODE = 00 to continue recording or terminate recording by Idle or Tail Cut command.

Host can suspend recording (Record command with REC MODE = 01). The D6571E will terminate recording and go to Idle mode. The Host can instruct the D6571E to perform another operation (other than Record), for example, CID, Tone Generation, etc. Note that message playback, voice prompt playback, and new message recording is not available during record suspend.

Then Host may instruct the D6571E to resume recording of the message that has been suspended. Alternatively the Host can close the suspended message and then start new message recording.

The Host may instruct the D6571E to change compression rate, enable/disable Gap Coding and Loopback (REC MODE = 11 and TONE GEN = 1). New mode will be set in the bits NEW BIT RATE (bits 8 - 6), LB DIS (bit 5), and GAP (bit 4).

Host can also instruct the D6571E to report current offset in the message being recorded (REC MODE = 11 and TON GEN = 0).

A message will not be stored in the Flash memory if the actual message length is less than 1 second. After performing the tail cut function, or if the message length is less than 1 second, the Garbage Collection Recommended bit will be set (1) in the status of the Read Memory Status command.

If the Flash memory has become full, the Memory Full bit (bit 7) in the status word is set. The D6571E stops recording, remains in Record mode, and continues to perform line monitoring.

During Record mode, the HOST can instruct the D6571E to generate a tone from the predefined tone table. The HOST should issue a Record command with the "T" bit (bit 9) set to "1", Tone Gain (bits 8-5) and "Tone Index" (bits 4-0). Tone generation will end if "Tone Index" is "00000" along with the "T" bit set to "1". For more details about tone generation, see Tone Generation command.

In Record mode, the input signal is "Looped Back" and transmitted through the output of the CODEC. This can be used for call screening or other purposes. If the "Loop Back" is not necessary, the HOST can disable this function by setting the "LB DIS" bit (bit 5) in the first record command to "1". The "LB DIS" bit should usually be set to "1" if the tone generation function during Record is used.

In case of "cold start" the Record will not be activated, the D6571E remains in Idle mode and returns Idle status.

### Playback

In playback mode, the D6571E performs message playback and line monitoring. In the first playback command, the HOST instructs the D6571E which message to play, and at what FLEXISPEECH speed. The message number is defined in bits 0-6 and can be from 0 to 127. The FLEXISPEECH speed is defined in bits 7-9. To play a message at normal speed, the FLEXI speed should be "000". Other playback speeds, from 0.5 to 2.0 (50% - 200%) of the normal speed can be selected according to the following table:

FLEXI SPEED			SPEED OF PLAYBACK
Bit 9	Bit 8	Bit 7	
0	0	0	1.0
0	0	1	0.5
0	1	0	0.7
0	1	1	1.0
1	0	0	1.3
1	0	1	1.5
1	1	0	1.75
1	1	1	2.0

The second playback command instructs the D6571E to play back the message from the predefined offset location. This offset information is defined in units of

## D6571E Data Sheet

about 0.64 seconds (0.93 seconds for PCM messages) for 8 KHz sampling rate. For 7.2 KHz sampling rate the unit is 0.704 seconds (1.03 seconds for PCM recording). If the offset is "0", the message will be played from the beginning. Message playback starts immediately after receiving the second playback command.

After starting playback, the D6571E monitors communication port for a HOST command every frame. The HOST issues additional playback commands during playback in order to perform line monitoring, change the speed of the playback, and/or pause playback. Usually, the HOST will issue an additional playback command and get back the line status every frame. Playback speed can be changed at any time while in playback mode by changing the FLEXI speed in any of the playback commands. If the PAUSE bit (bit 11) is set to "1", playback will stop. The playback will resume from the same point if the HOST issues the command with "0" in PAUSE bit. Line monitoring will continue during pause. If the READ OFFSET bit (bit 10) is high, the D6571E will return the current offset, i.e., the time elapsed from the beginning of the message, instead of the line status.

The line status word contains information about the tones detected from the line and End of Play flag (bit 7), which indicates whether the end of the current message has been reached. When this bit is low, the message is still being played; when it is high, the end of the message has been reached. The D6571E will continue to stay in playback mode and monitor the line. If the requested message number does not exist, the D6571E will return a status word with the End of Play "1" in response to the third playback command. If the D6571E detects a DTMF or CAS tone, the index of this tone will be reported (bits 03, 5) of the status word. See Line Monitor mode for respective indexes for DTMF tones. The presence of a Call Progress Tone will be contained in bit 4. The HOST will monitor these tones every frame and will act accordingly. Playback will be terminated by the Idle command and the D6571E will return to Idle mode. While in Playback mode, the Host may issue Commands to change independently the DTMF, VOX, CPT Sensitivity or the Volume Control without interrupting this mode. The status word will reflect the status for the Playback mode. Therefore, line monitoring will not be interrupted.

If the Host sends the command to play binary file, the D6571E will play silence and return status S3 with BIN bit and END of Play bit set to "1." See Data Storage mode in the Data Transfer Modes section for binary file storage information.

In case of "cold start" the Playback mode will not be activated, the D6571E will remain in Idle mode, and return Idle status.

### Read Memory Status

There are two submodes:

#### 1) Get memory status (*mode = 00*)

In this submode the D6571E returns to the HOST a status word containing the following information:

- Number of recorded messages
- Memory full indication
- Garbage Collection Recommended
- Program ROM status
- Voice Prompt status

When 128 messages have been recorded or when there is no available memory space for recording further messages, the Memory Full Flag (bit 7) is set. Up to 127 messages are reported in the 7 LSBs of the status word. When 128 messages are recorded, the Memory Full Flag is set and the number of messages is "0".

Note that the message directory may also become full if a large number of messages are deleted or not saved without running Garbage Collection.

The Garbage Collection Recommended bit is set to "1" when the telephone number table has been reprogrammed, when message(s) have been deleted, the tail cut function has been performed, or when messages are too short to be saved. This bit will be reset after garbage collection is performed.

In order to reduce response time of this command the calculation of the Voice Prompt checksum can be disabled if bit VP CHK DIS (bit 7) of the command is set.

After sending the memory status, the D6571E returns automatically to Idle mode.

In case of "cold start" the D6571E will return the status with the most significant nibble equal 0. This will be an indication of the "cold start". Voice Prompt status and Program ROM status bits have the same meaning as for "warm start". Number of messages, Memory Full, and Garbage Collection bits are expected to be 0.

#### 2) Get Product Number (*mode = 01*)

In this submode, the D6571E returns four digits of product number, i.e., 6571 (0110 0101 0111 0001). The

## D6571E Data Sheet

status is the same in “cold” and in “warm start” condition.

### Telephone Number Storage

In this mode the D6571E receives a word of data from the HOST and writes it into the telephone directory under the entry number specified by HOST in a previous command. This stored information can be actually used as telephone number storage or for any other purpose. The D6571E automatically returns to the Idle mode after this command. After a certain number of programming cycles, without Garbage Collection, the Telephone Number directory will become full. Up to 1024 bytes can be stored in the Telephone Number directory (128 telephone numbers, 16 digits each).

This mode is not available in case of “cold start.” Idle status will be returned.

### Non-Erasable Storage

In this mode the D6571E receives a word of data from the HOST and writes it into the Non-Erasable Storage under the entry number specified by HOST in a previous command. The D6571E can store up to 800 words (1600 bytes) of data. **This data can be programmed only once and can not be erased or modified.**

This storage is not available in case of “cold start.”

### General Purpose Storage (GPS)

The D6571E supports up to 16 sectors of the General Purpose Storage. Each sector has a capacity of 3200 bytes. The number of sectors has to be defined by Host (Storage Configuration command of the SelfTest and Initialization mode).

After a certain number of programming cycles, without Garbage Collection, the sector of the GPS will become full. After Garbage Collection the sector will become available for further programming. The D6571E allows erasing a sector by one command (GPS command with ERASE bit set).

**Note: Garbage Collection must be executed each time before and after writing data into GPS. Read Memory Status command should be sent and Garbage Collection should be executed if recommended.**

This storage is not available in case of “cold start.”

### Tone Generation Mode

In case of “warm start” the D6571E can generate tones from the following tone table:

TONE INDEX	DTMF CODE	FREQ. 0	FREQ. 1
0	No Tone		
1	1	697	1209
2	2	697	1336
3	3	697	1477
4	4	770	1209
5	5	770	1336
6	6	770	1477
7	7	852	1209
8	8	852	1336
9	9	852	1477
A	*	941	1209
B	0	941	1336
C	#	941	1477
D - 1F	User Defined Tones		

13 entries (0 - C) are preprogrammed and parameters of these entries can not be changed. The default gain for each tone in the table is 6 dB (code 0000) for Frequency 1 and 4 dB (code 0001) for Frequency 0.

The HOST can program 19 “user defined tones” one time. Any desired single or double tone within the telephony frequency bandwidth may be programmed as described in the section “New Tone Definition”. The HOST can instruct the D6571E to generate any of the 31 tones from the tone table.

To generate a tone, the HOST will send a Tone Generation command with bit 11 = “0”, bits 04 will indicate the TONE INDEX in the tone table and bits 5-8 will indicate the tone output gain. The D6571E will start to generate the tone through the CODEC output and monitor the line from the CODEC input. The D6571E will return a status word containing information on DTMF, CAS, and/or Call Progress Tones detected from the line. See Line Monitor mode for a descriptions of the call progress and DTMF tones detected. The HOST can issue an additional, same Tone Generation command to monitor the line, and will get a status word every frame. The HOST can change the tone and/or the tone gain level, on the fly, without leaving the Tone Generation mode. In addition the Host may issue a Sensitivity Control command to change sensitivity of any of the detectors without interrupting the Tone Generation mode. The status word will reflect the status of the Tone Generation mode. Therefore line monitoring will not be interrupted. The Tone Generation mode will end with the IDLE command.



## D6571E Data Sheet

In case of “cold start” the D6571E can generate silence and 16 standard DTMF tones from the table below.

TONE INDEX	DTMF CODE	FREQ. 0	FREQ. 1
0	No Tone		
1	1	697	1209
2	2	697	1336
3	3	697	1477
4	4	770	1209
5	5	770	1336
6	6	770	1477
7	7	852	1209
8	8	852	1336
9	9	852	1477
A	*	941	1209
B	0	941	1336
C	#	941	1477
D	A	697	1633
E	B	770	1633
F	C	852	1633
10	D	941	1633

Note that tones A, B, C, D (entries D - 10) are available in “cold start” but are not available by default in case of “warm start.” Entries D - 10 should be programmed by the user (User Defined tones) in case of “warm start.”

No User Defined Tones is available in case of “cold start.”

### New Tone Definition

The HOST can add tones to the table by sending the first Tone Generation command with bit 11 = “1” and the TONE INDEX in bits 4-0. The next three commands will define the new tone (single or dual). The second command defines “Tone 0” output gain in bits 0-3 and “Tone 1” output gain in bits 4-7. Each tone can be programmed from -24 dB (gain code 1111) to 6 dB (gain code 0000) with resolution of 2 dB. **The user defined tones may be programmed once only. Those tones can be programmed in case of “warm start” only.**

The third and fourth commands define the Tone 0 frequency and Tone 1 frequency respectively by the following expression:

$$32767 * \cos(2 * \pi * f_m / f_s)$$

where:  $f_m$  is the desired frequency and  $f_s$  is the sampling frequency (8000 Hz)

To define a single tone, either the third or fourth command has to be 7FFFH. The HOST will define new

tones from the Idle mode and the D6571E will return to Idle mode after the four commands/status sequence. The HOST can use the newly defined tone from the tone table immediately after the definition.

### FSK Modem

FSK modem is implemented as a submode of the Tone Generation mode. This mode allows to transmit and receive FSK data with 1200 baud rate. This mode is compatible with the CID receiver as well as with  $\alpha$ -5 function.

In this mode the D6571E receives byte stream from Host, converts it to FSK bit stream, and generates it in frames. The number of byte in the frame is specified by Host. The D6571E generates “leading mark bits” prior to the FSK frame. The D6571E generates start and stop bits for each byte of data (RS-232 protocol). The number of start and stop bits can be programmed by Host. After the frame has been transmitted the D6571E generates “trailing mark bits.” The number of “leading” and “trailing” mark bits is host programmable.

After completion of frame generation the D6571E can go to the FSK Receive mode without delay. In the FSK Receive mode the D6571E can report to Host the number of detected Channel Seizure bits and the number of detected Mark bits. Sensitivity (rejection threshold) of the FSK detector is host programmable (SelfTest and Initialization command, Test mode = 0111, submode = 100).

### Line Monitoring Mode

In this mode the D6571E monitors the telephone line for the detection of a DTMF signal, CAS signal, and/or existence of Call Progress Tones.

Caller Alert Signal (CAS) is a part of the Call Waiting CID protocol. The same signal with the name Idle State Tone Alert Signal is part of the V.23 protocol.

While in this mode, the D6571E is monitoring the communication port every frame for a HOST command. If no new command is detected, the D6571E continues monitoring the line.

If an additional Line Monitoring command is detected, the D6571E returns a status word to the HOST containing the Call Progress Tone flag (bit 4), and the index of the DTMF or CAS signal detected. The index is defined as follows:

## D6571E Data Sheet

EXT TONE	INDEX	DTMF CODE
0	0	No Tone
0	1	1
0	2	2
0	3	3
0	4	4
0	5	5
0	6	6
0	7	7
0	8	8
0	9	9
0	A	*
0	B	0
0	C	#
0	D	A
0	E	B
0	F	C
1	0	D
1	1-E	Reserved
1	F	CAS

In Line Monitoring mode, the input signal is “Looped Back” and transmitted through the output of the CODEC. This can be used for call screening or other purposes. If the “Loop Back” is not necessary, the HOST can disable this function by setting the “LB DIS” bit (bit 5) in the first Line Monitor command to “1”.

While in Line Monitoring mode the D6571E allows control of the Volume level of the looped backed signal without interrupting the Line Monitor Mode. The volume can be controlled in 2 dB steps from +16 dB down to -42 dB and also includes Mute. While in the Line Monitoring mode the Host may change independently the DTMF, VOX, CPT, and CAS Sensitivity without interrupting the Line Monitoring mode. The status returned for the Volume control or Sensitivity control command will be the status of the Line Monitoring mode. Therefore, the line monitoring function will not be interrupted. The D6571E will stop monitoring the line and return to Idle mode when an Idle command is sent.

The Detector Configuration command (submode of the Initialization mode) defines if the D6571E will report detection of the A, B, C, D digits. By default the D6571E reports 12 digits only (indexes 1 - C).

The Line Monitor mode has the same performance in case of “cold” and “warm start.”

### CID Submode

To monitor for CID information, Line Monitor command should be sent with CID bit (bit 10) set. The D6571E will return an ASCII code of the detected character in the low byte of the status word. MS bit of the ASCII byte will be sent in bit 7 of the status word. LS bit of the ASCII byte will be sent in the bit 0 of the status word.

If no Seizure Signal is expected to be detected (off-hook detection) the NS bit (bit 8) should be set in the CID command.

CID command should be sent repeatedly until the entire CID message is received. In average 3 command/status will be transmitted per frame.

If no character is detected the D6571E will return status with bit ND (bit 8) set and zero in low byte. In case of no detection the status will be returned once each frame.

CID mode performance is the same in case of “cold” and “warm start.”

### Delete Message

In this mode the D6571E performs one of the following functions:

1. If the Garbage Collection bit (bit 11) is 0, the D6571E removes the message entry specified in bits 06 from the message directory, shifts all higher message entries one place down in the directory and decreases the total number of messages by one. Deletion of a message will not free up memory space until a Garbage Collection command is performed. The Garbage Collection Recommended bit, in the status word of the READ MEMORY STATUS command, will be set after message deletion.
2. If the Garbage Collection bit is 1, the D6571E performs Garbage Collection to free memory space by erasing sectors. The Garbage Collection erases one sector per command. After erasing the last sector, the D6571E returns the status 8880H. The Garbage Collection Recommended bit, in the status word of the READ MEMORY STATUS command, will be reset after erasing the last sector.

### Note:

- 1) The D6571E returns Garbage Collection status automatically after each release of RESET signal from the chip. In the case of “cold start”, bit 0 will be set (1). In the case of “warm start”, bit 0 will be reset (0).

## D6571E Data Sheet

2) In case of “cold start” neither Delete nor Garbage Collection command is being performed. Both commands return Idle status.

### **Erase Flash**

The D6571E allows to erase the entire flash (with the exception of the bad block table). To perform erase operation the ERASE commands should be sent twice. After sending the second command the contents of the flash including Voice Prompt will be erased. This command can be used on the development stage to clean used flash. This command is not recommended to be used in actual applications.

**The ERASE command must not be used with the flash that has not been initialized yet.**

The Erase command performs in the same way in case of “cold” and “warm start.”

### **Set/Modify Time Stamp**

In this mode, the Host sends the D6571E the data that will be attached to the next recorded message. Up to 2 words (4 bytes) may be attached to each message. Usually the Host sends the D6571E the current time and date mark that will be used for time and date stamping of the messages. Time stamp or any other data stored in these two words can be retrieved by Get Time Stamp command. The D6571E automatically returns to the Idle mode after this command.

Any bit of the Time Stamp can be modified from “1” to “0” by the Modify Time Stamp command after message has been recorded. No modification from “0” to “1” is available. Therefore it is recommended that all non used bits will be set to “1” by Set Time Stamp command.

This command is not available in case of “cold start”. The D6571E will return Idle status.

### **Get Time Stamp**

In this mode the D6571E sends the Host the data that was attached to the recorded message. Usually this will be the current time and date. The D6571E automatically returns to the Idle mode after the Set Current Time command.

This command is not available in case of “cold start”. The D6571E will return Idle status.

### **Get Available Record Time**

In this mode, the D6571E sends the HOST the minimum available Flash memory record time in units of memory. Time representation of the units depends on the compression rate to be used.

The D6571E automatically returns to the Idle mode after this command. The D6571E will return Idle status in case of “cold start.”

### **Self Test and Initialization**

In this mode the D6571E performs memory configuration, mapping, and testing, initialization of the system parameters as well as various selections related to the CODEC interfaces, data storages, signal detectors, etc. This mode allows also Volume Control and Sensitivity Control of DTMF, VOX, CAS, and CPT detectors.

#### *1) Flash Initialization (Test Mode = 0001)*

This command initializes the flash memory. **This command may be used immediately after the Flash Hardware Selection command.**

Flash memory can not be addressed in functional modes before it is initialized. This command destroys the contents of the memory except the Voice Prompt blocks and bad block table.

Initialization is necessary to activate external VP ROM even if no flash is installed in the system.

#### *2) Flash Fast Test (Test Mode = 0011)*

This command is not needed for normal operation. It can be used to confirm the flash configuration. It gives a fast indication that the memory devices are installed and functional. This command can only be used after a Flash Hardware Selection command. It destroys the contents of the memory except the Voice Prompt blocks and bad block table.

**Flash must be initialized after using Flash Fast Test command**

#### *3) Flash Hardware Selection (Test Mode = 0101)*

The Host must send this command to the D6571E in order to initialize and map the system memory. This command be issued first, because Flash Fast Test and Flash Initialization command should follow Flash Hardware Selection command. Neither Flash Fast Test

## D6571E Data Sheet

(Test Mode = 0011) nor Initialization (Test Mode = 0001) are available if they don't follow Flash Hardware Selection command.

### 4) Codec Hardware Selection (Test Mode = 0100)

This command configures the system for the various codec interface operating modes available.

M/S - Configures the D6571E to operate in either Master or Slave mode of the Codec Interface.

LAW - Configures the D6571E to operate with either an  $\mu$ -law Codec (default) or an A-law Codec.

CODEC Type Selection - allows selection of short (default) or long frame sync for the CODEC interface.

When two CODECs are connected to the D6571E, the HOST can select the input or the output CODEC for each function. If CODEC0 is connected to the telephone line and CODEC1 is connected to the microphone and speaker, the HOST can select to record or play through each one of the CODECs. CODEC Selection enables the following options with a 2-CODEC configuration.

INPUT CODEC - allows selecting the input data streams from CODEC0 and CODEC1.

CODEC INPUT	
Bit 2	
0	Input through CODEC0 (default)
1	Input through CODEC1

OUTPUT CODEC - allows selecting the CODEC output between CODEC0 or CODEC1 (or both).

CODEC OUTPUT		
Bit 4	Bit 3	CODEC
0	0	(Default mode.) Output data stream in the Record, Playback, Tone Generation, Line Monitor, Voice Prompt modes is directed to CODEC0 (via pin TX0). In the SpeakerPhone mode signal to the telephone line is directed to CODEC0, signal to the speaker to CODEC1 (via pin TX1). This mode should be used for SpeakerPhone operation.
0	1	Output data is directed in all modes only to CODEC1 (via pin TX1).
1	0	Output data is directed in all modes only to CODEC0 (via pin TX0).

1	1	Data is directed in all modes to both CODECs.
---	---	-----------------------------------------------

A RESET signal will set all codec configurations to the default values.

Codec Selection command has the same performance in case of "cold" and "warm" start.

### 5) Codec Loopback (Test Mode = 0110)

Activates Codec loopback. This mode is available in case of "cold start."

### 6) Algorithm Configuration (Test Mode = 0111)

#### Submode 000 = DTMF Configuration

This command configures DTMF detector (sub mode 0) to report detection of 12 digits (0-9, \*, #) or 16 digits (0-9, \*, #, A, B, C, D). By default the D6571E is in 12 digit mode.

#### Submode 001 = CAS Configuration

Allows to change threshold levels of the CAS detector

#### Submode 010 = AGC Configuration

This command activates AGC. AGC, when activated, is functional in the Record mode. Main parameters of the AGC are programmable and can be defined by the AGC Configuration command. By default AGC is disabled.

#### Programmable AGC Parameters

The following Parameters can be programmed by Host using AGC Configuration command.

**Optimum Level Eopt** - desired output level after AGC operation. For input signals of Eopt level the AGC will set gain = 1. Input signals greater than Eopt will be attenuated. Input signals smaller than Eopt will be amplified.

## D6571E Data Sheet

**Minimum Level Emin** - minimum input signal energy level that is amplified to optimum value Eopt. For signals greater than Emin the AGC gain is calculated as

$$G = E_{opt}/E_{input}$$

Maximum gain  $G_{max} = E_{opt}/E_{min}$

**Gain Threshold Level Eatt** - signals smaller than Emin and larger than Eatt are amplified by maximum gain Gmax

**Silence Threshold Level Esil** - signals lower than Esil are considered silence. The gain for such signals = 1. Signals greater than Esil but smaller than Eatt will be amplified by the gain linearly growing from 1 to Gmax.

**Hold Time Thold** - this parameter the hold time of the AGC gain during the pause in the speech. The intent of the decay time is to “bridge” the gaps between syllables and words resulting in stable gain.

**Decay Time Tdec** - this parameter defines the rate by which the gain increases after hold time elapsed.

Default values of the parameters are presented in the following table.

Parameter	Default Value (decimal)	Default Value (hex)	Default Value (Physical meaning)
Eopt	4 dB	0004	- 1 dBm*
Emin	22 dB	0016	- 19 dBm*
Eatt	36 dB	0024	- 33 dBm*
Esil	46 dB	002E	- 43 dBm*
Thold	100	0064	2.0 sec
Tdecay	10	000A	1.0 sec

\* - Calculated as (3 - Value) dBm

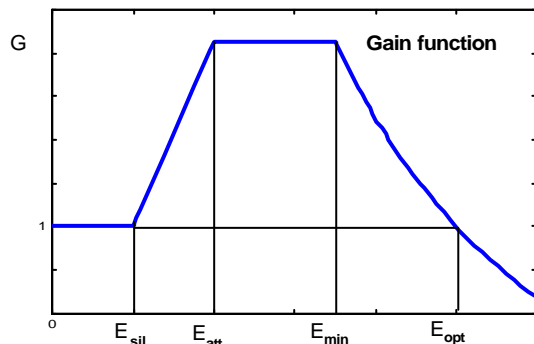

**Submode 011** = HPF configuration

Submode 3 enables low pass filter (enabled by default).

The performance of this mode is the same in case of “cold” and “warm start.”

**Submode 100** = FSK configuration

This submode allows to control sensitivity of the FSK detector.

7) *Volume Control (Test Mode = 1000)*

This mode allows setting of the signal level playing to the Codec. The default value is 0 dB and the volume may be set in 2 dB steps from -42 to +16 dB or may be muted.

This command allows the HOST to read the current volume setting without changing it (bit 7 = 0), or set new volume (bit 7 = 1) specified in bits 0 through 4. The status will reflect the current volume setting.

The Volume Control command can be issued in Record, Playback, Voice Prompt and Line Monitor Mode without interrupting these modes. When issued in one of these modes, the status will be the status of the current operating mode. Therefore, current volume setting can not be read during operating modes.

The performance of this mode is the same in case of “cold” and “warm start.”

8) *Storage Configuration (Test Mode = 1001)*

This mode allows to define necessary space of the General Purpose Storage. GPS can occupy up to 16 sectors 3200 bytes each sector. By default GPS is not available (0 sectors).

9) *Program DTMF, VOX, CPT, CAS Sensitivity (Test Mode = 1010)*

The mode allows independent setting of the sensitivity of the DTMF detection, CAS detection, VOX detection, and Call Progress Tone detection. The default sensitivity level is 0 dB and each sub-system may be adjusted in 2 dB steps from -16 dB (most sensitive) to +42 dB (least sensitive) or can be disabled.

This command also allows the HOST to read the current sensitivity setting of the selected signaling subsystem (specified in bits 6 - 7) without changing this setting (bit 5 = 0). When bit 5 = 1, the command sets the new

## D6571E Data Sheet

sensitivity value specified in bits 0 through 4. The Status will reflect the sensitivity settings.

The Sensitivity Control command can be issued in Record, Playback, Voice Prompt, Line Monitor, and Tone Generation Mode without interrupting these modes. When issued in one of these modes, the status will be the status of the current operating mode. The current sensitivity setting can not be read during operating modes.

The performance of this mode is the same in case of “cold” and “warm start.”

### 10). Test Mode = 1011 (GPIO access).

In this mode the D6571E allows Host access to GPIOs. Host can write and read data to/from GPIOs using this command.

### 11). Test Mode = 1101 (IOM-2 compatible codec interface configuration)

In this mode the D6571E sets configuration of the GCI/IDL compatible codec interface. By issuing this command Host activates GCI/IDL compatible codec interface. By sending Codec Hardware Selection command (Test Mode = 0100) host disables GCI/IDL interface and activates “old” codec interface. By default “old” codec interface is active. See command set for details.

## Voice Prompt Generation

In this mode the D6571E plays back a speech segment using the speech decompression algorithm. Speech should be previously stored in Flash memory or external ROM. The D6571E will support up to four 64K byte sectors. Each sector will store up to 128 prompts. The default sector is sector 0. If the Host is playing from sector 0 only, no Set Sector command is required. If however, the Host selects sector 1 this continues to be in effect until the Host changes it again. In addition, the Host may change the sector while in Idle mode without leaving Idle mode and this change will remain in effect until another command is issued to change the voice prompt sector. As a general procedure, the Host first sets the sector by setting bit 10 and including the sector number in bits 2-0. Next, the Host loads the new phrase by setting bit 11 and including the phrase number to play (0-127) in bits 06 in the command word. The D6571E will start playing the phrase and send the status word to the HOST containing line status and playback status. The line status will contain information about

DTMF, CAS, and CPT in the same manner as the Line Monitor command. The status word also contains two flags: END OF PLAY and READY. The HOST can continuously monitor the status by issuing a Voice Prompt command with both bit 10 and 11 equal 0 and act according to the returned flags.

READY - this bit (bit 10) is set to “1” by the D6571E two frames before the end of the phrase playback. It indicates that the D6571E is ready to load a new phrase. If the Host is playing from the same sector, no additional set sector command is required.

**The Host may send a change sector command, if required, during the playback from the previous sector without interrupting the playback. The next phrase will be loaded from the new sector.** Sending a Load command while the READY bit is “0” will not load the new phrase. If the HOST sends Load command immediately after status with READY bit high, there will be no silence gap between the two phrases. The HOST can delay the Load command for a few frames and create a gap between two phrases. In that case, the D6571E will transmit silence to the CODEC but will stay in Voice Prompt mode. The Voice Prompt mode supports FlexiSpeech in a manner similar to Playback mode.

ENDOFPLAY - this bit (bit 7) is set one frame after the Ready bit and indicates that the D6571E is playing the last frame of the phrase.

While in Voice Prompt Generation mode, the HOST may issue a command to change the DTMF, CAS, VOX, and CPT Sensitivity or the Volume without interrupting this mode. The status word will reflect the status for Voice Prompt mode. Therefore, line monitoring will not be interrupted. The Voice Prompt mode is terminated by sending an Idle command.

The external ROM can be used as the Voice Prompt storage if only one 4M flash is activated in the system or no flash is installed.

Notes:

1) If the phrase number is higher than the last phrase recorded in the memory, the status word will return END OF PLAY with READY bits high and no playback will be performed.

2) If the D6571E does not find the Voice Prompt area it will return Idle status.

## **D6571E Data Sheet**

3) The external Voice Prompt should be initialized using Flash Hardware Selection and Flash Initialization command. The external Voice Prompt should be initialized even in case of “cold start”.

4) The amount of recording time for voice prompts depends on the number of sectors allotted in the Flash memory and it is 71 seconds for each 32 Kbytes of memory space.

### **Program Voice Prompt**

In this mode the D6571E allows programming of the Voice Prompt file into flash memory using the data pump technique. See Voice Prompt command set for details.

## D6571E Data Sheet

### Full Duplex SpeakerPhone Operation

In this mode the D6571E implements a HOST controlled Digital SpeakerPhone algorithm. When activated, this algorithm enables enhanced SpeakerPhone operation with both Acoustical and Electrical Echo Cancellation and programmable parameters. CODEC0 is used for the telephone line input and output. CODEC1 is used for the microphone input and the speaker output. (This is the default setting of the Codec).

The SpeakerPhone command is comprised of two commands. The first command defines the “static” parameters, which usually are optimized to the specific hardware setup (microphone and speaker locations, amplifier gains, etc.). This command can be issued once only while in SpeakerPhone mode. The second command will define the “soft” parameters that can be changed by the HOST during SpeakerPhone operation (loop attenuation, speaker volume, etc.). The second command can also define echo cancellation and loop adjustment modes as well as instruct the D6571E to generate a tone from the predefined table.

**SpeakerPhone function has the same performance in case of “cold” and “warm” start.**

### Explanation of the SpeakerPhone Parameters

#### Static Parameters (First Command)

*R/T ratio (bits 11-10) and T/R ratio (bits 9-8)*

This is ratio of transmit and receive signals. This ratio is used to determine which side is speaking. If the T/R ratio is greater than the set level, this is an indication that the microphone side is speaking. Conversely, if the R/T ratio is greater than the set level, this is an indication that the line side is speaking.

*Priority (bit 1)*

The system has two ways of behaving when neither side is speaking. If this parameter is set to “0” - (no Priority), the attenuation will be equally split between two sides. If, for example, the total loop attenuation is 16 dB, when one side is active, the other side is attenuated by 16 dB. If no one is speaking, both sides will be attenuated by 8 dB. If the parameter is “1” - (Near Side Priority), the telephone line side will be attenuated (by 16 dB) and the microphone side will be open (0 dB) when neither side is speaking.

*VOX Sensitivity*

The line and microphone sensitivity determine the Signal-to-Noise (SNR) ratio at which the voice detectors for the transmit and receive directions will be activated. The voice detectors are used to determine which direction is talking.

*Line VOX Sensitivity (bits 7-5)*

This parameter will control the sensitivity of the VOX from the line side.

*Mic VOX Sensitivity (bits 4-2)*

Same as above for the microphone input.

### “Soft” Parameters (Second Command and On)

#### Mode = 0000 (SpeakerPhone Status)

In this mode, the D6571E reports to the HOST the current SpeakerPhone status.

*Loop Attenuation (bits 2-0)*

This indicates the actual amount of loop attenuation currently in use. See the Command Set description for possible values of this parameter.

*Direction (bits 7-4)*

This indicates which direction (microphone/speaker) is considered active by the D6571E SpeakerPhone control logic. This is a 4-bit field used to represent the number range from +7 to -8. The most positive values indicate that the signal coming from the microphone is dominant (microphone is speaking). The most negative values (2's complement) indicate that the signal coming from the line side is dominant (telephone line is speaking). Values in the center range can either indicate a transition from one side to the other, or if the value stays at approximately the zero position, that neither side is talking. See the Command Set description for possible values of this parameter.

#### Mode = 0001 (Line Status)

The D6571E monitors in this mode the telephone line and reports the result of the CAS detection. The status is updated by the D6571E every 16.5 msec. The D6571E allows to send any other SpeakerPhone command and receive status accordingly without interrupting CAS detection (other SpeakerPhone commands have much shorter response time). When set NEW STATUS bit



## D6571E Data Sheet

(bit 7) indicates that information in the Line Status has not been read by Host yet. This bit will be set by the D6571E each time when the status is updated by the D6571E. The bit will be reset to 0 each time when the status is read by the Host

### *DTMF, Tone, Ext. Tone (bits 0-5)*

See SpeakerPhone command description and Line Monitor mode description for the bit assignment.

### *New Status (bit # 7)*

When set indicates that the status has been updated by the D6571E and has not been read yet by the Host. Will be set to 1 by the D6571E each time when the D6571E updates the status. Will be reset to 0 after Host reads the status.

### **Mode = 001 (SpeakerPhone Parameters)**

In this mode, the D6571E sets the “soft” SpeakerPhone parameters.

### *Speaker Volume (bits 6-3)*

This parameter will control the Speaker output signal level. See the Command Set description for possible values of this parameter.

### *Line Volume (bits 8-7)*

This parameter will control the volume transmitted to the telephone line. See the Command Set description for possible values of this parameter.

### *Loop Attenuation (Bits 2-0)*

This parameter defines the target loop attenuation in the system. See the Command Set description for possible values of this parameter. Also see the description at the end of this section for a description of the Loop Adjustment mode.

### **Mode = 010 (SpeakerPhone Configuration)**

In this mode, the D6571E sets the echo cancellation and loop adjustment modes.

### *Automatic Loop Adjustment (Bits 1-0)*

This parameter controls the loop attenuation allowing for automatic control or a specific setting for abnormal

conditions. See the Command Set description for possible values of this parameter. Also see the description at the end of this section for a description of how the SpeakerPhone is controlled in the various modes available.

### *Line Training (Bits 3-2)*

This parameter sets the type of training of the EEC. The default and recommended mode is Voice Adaptation mode. Alternatively white noise can be injected to the telephone line. Then the D6571E will automatically returns back to the voice adaptation mode. See the Command Set description for possible values of this parameter. Also see the description at the end of this section for a description of how the SpeakerPhone is controlled in the various modes available.

### *Twist (bit 6-7)*

Defines the twist of the DTMF tone generated in the SpeakerPhone mode. Twist defines the attenuation of the lower frequency of the dual frequency signal.

### *DT (bits 5-4)*

Defines the threshold for the Dial Tone detector. Level below the threshold is considered noise and would not be detected.

### **Mode = 011 (SpeakerPhone Configuration 2)**

Defines additional options for the SpeakerPhone.

### *Speaker Noise (bit 7)*

When the Speaker Noise bit is set, a white noise pulse of duration 250 msec is injected into the speaker. After the pulse the DSP automatically returns to the adaptation mode of the AEC.

### *Line Noise (bit 6)*

When the Line Noise bit is set, a white noise pulse of duration 250 msec is injected into the line. (This is equivalent to Line Training Type 1 in the SpeakerPhone Configuration Command). After the pulse the DSP automatically returns to the adaptation mode of the LEC.

### *Line Processing (bit 5)*

This option allows additional linear processing to reduce the far end residual echo by 6 dB.

## D6571E Data Sheet

### Mic VOX Position (bit 4)

Defines position of the Mic VOX detector before the volume compensater (default) or after the volume compensater.

### Line VOX Response (bits 1-0), Mic VOX Response (bits 3-2)

Defines frequency response of the Line and Mic VOX detectors (flat or high pass filter).

### Mode = 100 (Tone Generation)

In this mode, the D6571E will generate tones.

### Tone Index (bits 4-0) and Tone Gain (bits 8-5)

Allows to generate 16 DTMF tones from the redefined tone table. No user defined tones are available in the SpeakerPhone mode. Even in case of “warm start” DTMF will be generated according to the “cold start” protocol in this mode. See the Tone Generation command for usage and definitions.

To start generation the Host should send Tone Generation command (Mode = 100). To stop generation and return to SpeakerPhone, the HOST should send a Second SpeakerPhone Command other than Tone Generation (for example, Get Speaker Phone Status).

### Mode = 101 (SpeakerPhone Parameters 2)

The Set SpeakerPhone Parameters 2 Command (Mode 101) allows additional control over the range for the Loop Attenuation, Speaker Volume, Line Volume, and T/R and R/T ratios. If extended range is not a requirement, the Set SpeakerPhone Parameters Command (Mode 001) can be used rather than this command. This command also introduces the Acoustical Decoupling and Electrical Decoupling parameters.

*Parameter (bits 8-6):* Defines the parameter to be set.

- = 000: Loop Attenuation
- = 001: Speaker Volume
- = 010: Acoustic Decoupling
- = 011: Line Volume
- = 100: Electrical Decoupling
- = 101: T/R and R/T ratios
- = 110: Reserved

= 111: Reserved

*Value (bits 5-0)*

Defines the value of the parameter to be set. **Speaker Volume** and **Line Volume** is equivalent to the parameters defined by Set SpeakerPhone Parameters command with the exception that this command extends the range of these parameters from - 20 dB to + 20 dB. **The Loop Attenuation** is the same as in the Set SpeakerPhone Parameters command. **R/T and T/R ratios** are the same as for the First SpeakerPhone command with the exception that the range of control is extended to 4.

**Acoustical and Electrical Decoupling** should be set by Host according to the actual hardware design Those parameters define the actual volume compensation that will set by the D6571E.

If the Speaker Volume is more than 0 dB the D6571E will activate Speaker Volume Compensation. This compensation will be active until AEC will be trained. Then it will be deactivated. The amount of compensation introduced by the D6571E is:

Speaker Volume Compensation = Speaker Volume - Acoustical Decoupling.

The default value of the Acoustical Decoupling is 0 dB. If this parameter is not set by Host the Speaker Volume compensation = Speaker Volume.

Similarly if the Line Volume is more than 0 dB the D6571E will activate Line Volume Compensation. This compensation will be active until EEC will be trained. Then it will be deactivated. The amount of compensation introduced by the D6571E is:

Line Volume Compensation = Line Volume - Electrical Decoupling.

The default value of the Acoustical Decoupling is 0 dB. If this parameter is not set by Host the Speaker Volume compensation = Speaker Volume.

Use of this parameters allows to reduce Volume Compensation in the D6571E SpeakerPhone. Please, note that Volume Compensation is valid only at the beginning of the conversation when the echo cancellers are not trained.

### Control of Available Modes

The D6571E SpeakerPhone system actually contains two digital echo cancellers: an adaptive acoustical canceller (AEC) which cancels the acoustical echo

## D6571E Data Sheet

between microphone and speaker, and an adaptive electrical echo canceller (EEC) which cancels the echo caused by the 4-to-2 wire telephone line connection.

### Automatic Loop Adjustment Mode

When starting the SpeakerPhone mode, both of the echo cancellers are at their initial point. They are not trained and provide no cancellation. By default the D6571E starts the SpeakerPhone with increased level in order to guarantee that the system will be stable. When the echo cancellers have converged, the additional loop attenuation is removed.

The D6571E starts operation with the “target” Loop Attenuation + 12 dB. This attenuation will be reduced to “target” value once echo cancellers get trained. The default setting of the D6571E is: target Loop Attenuation 8 dB, starting point is 20 dB, which will be reduced to 8 dB. The Host can set any desired “target” value of the Loop Attenuation.

If the D6571E is unable to provide efficient echo cancellation it will (temporarily) introduce an additional attenuation in order to prevent howling or feedback. This happens if the D6571E determines that it is unable to cancel either acoustical echo or electrical echo by adjusting the echo canceller coefficients. Additional Loop attenuation will be introduced if the Speaker Volume or Line Volume is increased or if the target Loop Attenuation is decreased by Host to ensure the smooth transaction. The D6571E will restore the target loop attenuation selected by Host by reducing the additional attenuation in steps of 4 dB once efficient cancellation is achieved.

The Automatic Loop Adjustment mode is the default mode. It can be also selected by the SpeakerPhone configuration command (Mode = 10, Loop Adjustment = 10).

If the actual Loop Attenuation is more than 0 dB the SpeakerPhone operates by dynamically distributing the loop attenuation selected between the receive and transmit attenuators providing natural non-interrupted conversation even with the loop attenuation higher than 0 dB. The D6571E makes a decision as to which direction is talking and then rapidly shifts the attenuation to the opposite direction.

### Voice Adaptation of the Echo Cancellers

The D6571E has two echo adaptive cancellers. Both of them are adapting to speech. When microphone side is speaking the EEC updates its coefficients. The AEC

updates its coefficients when telephone line side is speaking,

The Voice Adaptation mode is default mode of the D6571E. Alternatively the D6571E can send the noise pulse to train echo cancellers. After sending training pulse the D6571E would return to the Voice Adaptation mode. The Voice Adaptation mode without any training pulse is the recommended one.

Also if the user desires to change the volume of the speaker, this should be done via the D6571E and not by changing the external speaker amp lification.

### Re-Compression Mode

This mode allows to change compression rate of the recorded message. First command C1 specifies message to be re-compressed. Second command C2 specifies new compression rate. Re-compression starts after C2 command. Host can send C3 command continuously to monitor progress of the re-compression operation.

READY bit will be set when re-compression is complete. ERROR bit will be set if message to be recompressed does not exist, or if this a PCM or binary message.

If memory full is reached the D6571E will set bit MEM FULL and terminate re-compression. Old message will be saved (before recompression), re-compressed message will be deleted.

**Note: Garbage Collection must be executed before re-compression and after each re-compression.**

## D6571E Data Sheet

### HOST INTERFACE PERFORMANCE

The D6571E maximum response times to HOST commands (for Samsung flash) are as follows:

COMMAND	MAX STATUS RESPONSE TIME*
Idle	1 ms
Idle after functional modes	11- 12 ms
Record	1 frame
Tail Cut	50 ms
First Playback	2 ms
Second Playback (offset)	1 sec
Next Playback (Continue)	1 frame
Line Monitor	1 frame
Delete Message	5 ms
Garbage Collection	5.1 sec
Set Current Time	2 ms
Get Time Stamp	4 ms
Get Available Record Time	1 0 ms
Read Memory Status (VP chksum disabled)	30 ms
Read Memory Status	30 ms + 1.95 sec for each VP sector
Write Telephone Number	2 ms
Read Telephone Number	1 ms
Tone Generation (three program commands)	2 ms
Tone Generation ( Continue)	1 frame
Voice Prompt Generation	1 frame
SpeakerPhone	2 ms
Initialization	2.2 sec
GC status after RESET ("Cold Start")	3 sec
GC status after RESET ("Warm Start")	40 ms

\* with 4M Samsung Flash

1 frame is 30 ms for 8 KHz and 33 ms for 7.2 KHz sampling rate

The D6571E maximum response times to HOST commands (for Toshiba flash) are as follows:

COMMAND	MAX STATUS RESPONSE TIME*
Idle	1 ms
Idle after functional modes	11- 12 ms
Record	1 frame
Tail Cut	850 ms
First Playback	2 ms
Second Playback (offset)	1 sec
Next Playback (Continue)	1 frame
Line Monitor	1 frame
Delete Message	10 ms
Garbage Collection	5.1 sec
Set Current Time	2 ms
Get Time Stamp	4 ms
Get Available Record Time	60 ms
Read Memory Status (VP chksum disabled)	60 ms
Read Memory Status	60 ms + 4.5 sec for each VP sector
Write Telephone Number	40 ms
Read Telephone Number	5 ms
Tone Generation (three program commands)	6 ms
Tone Generation ( Continue)	1 frame
Voice Prompt Generation	1 frame
SpeakerPhone	2 ms
Initialization	2.2 sec
GC status after RESET ("Cold Start")	3 sec
GC status after RESET ("Warm Start")	250 ms

\* with 4M Toshiba Flash

1 frame is 30 ms for 8 KHz and 33 ms for 7.2 KHz sampling rate

## SPEAKERPHONE

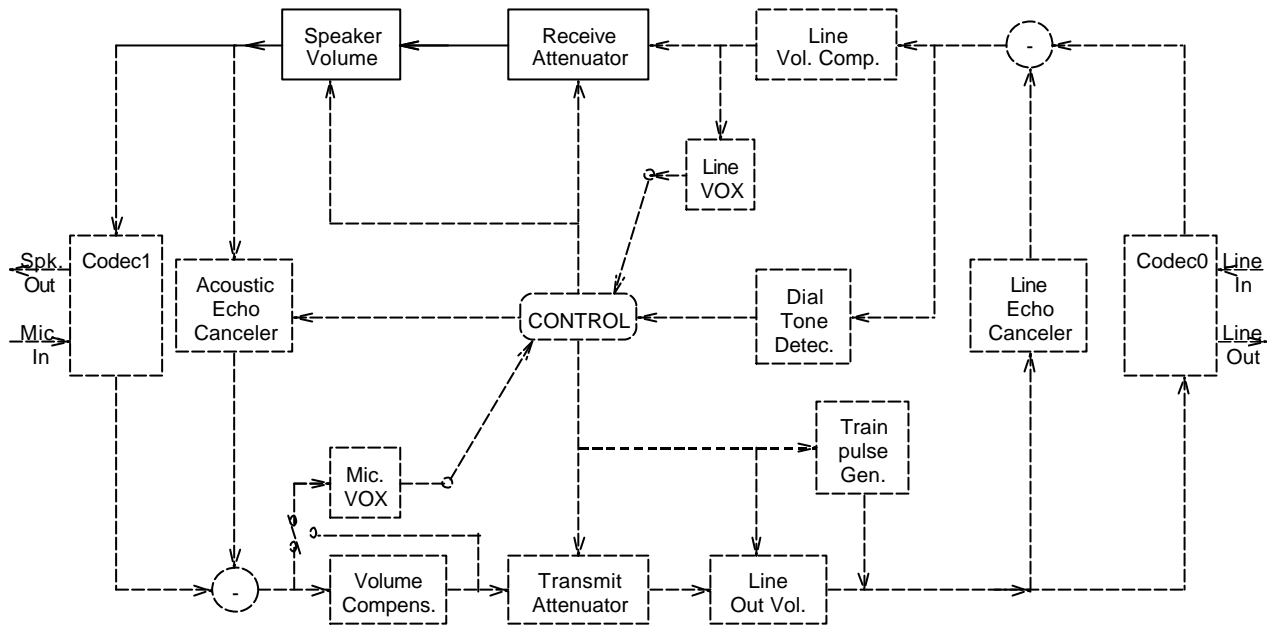

*Figure 3a. Digital Part*

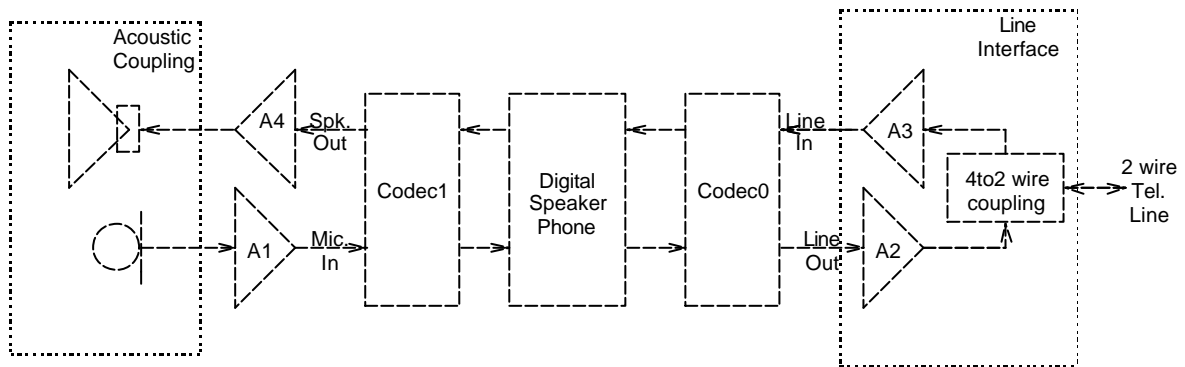

*Figure 3.b - Acoustic and analog parts*

**Figure 3. Speakerphone Block Diagram**

## D6571E Data Sheet

### Power Down Operation

The D6571E needs only one source of power:

- VCC - 5VDC that supplies power only during power on, connected to the CODEC, Memory and other components.

Power fail indication signal is supplied to the D6571E through the PDN pin (pin 22). A RESET input signal is also connected to the D6571E (pin 21).

During the power on sequence, the PDN\ signal of the D6571E and the WP\ signal of Flash should go high after Vcc and crystal oscillation have become stable (usually 20-50 msec after Vcc is high). The RESET

signal may go high together with Vcc or with delay. Please, note that the D6571E will be in an undefined state before high level of the RESET signal is applied. The RESET signal should go low after Vcc and crystal oscillation have become stable and with minimum delay of 1 msec after WP\ is high. RESET pulse should be at least 10  $\mu$ sec long.

When power is being disconnected, the PDN signal should go low and the D6571E will enter power down mode. Then WP\ pin of the Flash should go low with minimum delay of 2 msec after PDN\ is low. The WP\ should go low before the Vcc drops below 4.5V. Please, note that the WP\ pin of the Flash IC should be low when Vcc is below 4.5V.

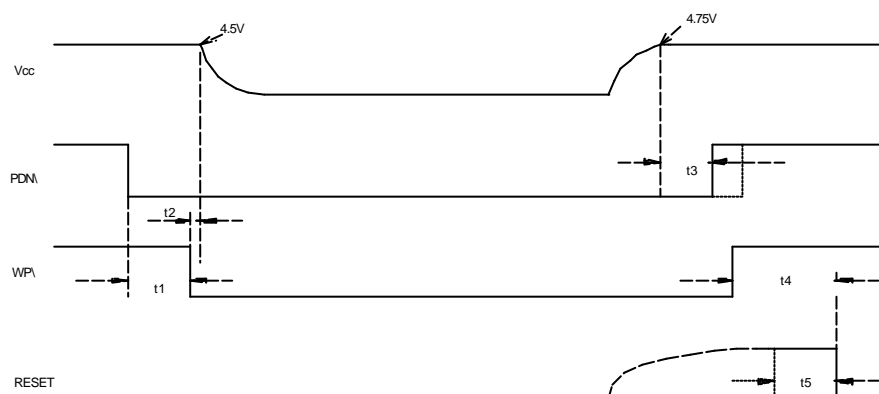

**Figure 4. Power Up and Power Down Timing Diagram**

t1	> 3 msec
t2	> 0
t3	20-50 msec
t4	> 1 msec
t5	> 10 $\mu$ sec



## D6571E Data Sheet

### Command (C2):

0001	REC MODE	TONE GEN	COMMAND BITS
(15-12)	(11-10)	(9)	(8 - 0)

REC MODE	TONE GEN	
0 0	0	Continue recording or stop record with Tail Cut
0 0	1	Continue recording or stop record with Tail Cut and generate new tone
0 1	0	Suspend Recording - the D6571E terminates recording (message recording can be resumed later or message can be closed, see RESUME and CLOSE bits of the C1 command);
1 0	0	Pause Recording (the D6571E stays in Record mode and monitors line but doesn't store data into the flash memory), the D6571E will continue recording after receiving Record command with Rec Mode = 00
1 0	1	Same as above plus new tone will be generated
1 1	0	Read Offset, the D6571E will report current offset within the message
1 1	1	Change compression rate (allows switching between different compression rates as well as enable and disable gap coding and codec loopback). Switching from/to uncompressed recording is not allowed.

### When REC MODE = 00 or 10 (Continue Recording or Pause)

#### Command (C2):

0001	REC MODE	TONE GEN	TAIL CUT FACTOR(if TONE = 0) or TONE INDEX + GAIN (if TONE = 1)
(15-12)	(11-10)	(9)	(8 - 0)

When TONE GEN = 0:

(C2):

0	0 0	TAIL CUT FACTOR
(9)	(8 - 7)	(6 - 0)

TAIL CUT FACTOR = 0:

Continue record and monitor status

TAIL CUT FACTOR = non zero:

End record and cut message tail in memory by TAIL CUT FACTOR \* TCF

For 8 KHz sampling rate TCF = 160 ms for TrueSpeech compression and 240 ms for PCM recording

For 7.2 KHz sampling rate TCF = 178 ms for TrueSpeech compression and 266 ms for PCM recording

When TONE GEN = 1:

(C2):

1	TONE GAIN	TONE INDEX
(9)	(8 - 5)	(4 - 0)



## D6571E Data Sheet

### When REC MODE = 11 and TONE GEN = 1 (Change Compression Rate)

#### Command (C2):

0001	1 1	1	NEW BIT RATE	LB DIS	GAP	0 0 0 0
(15-12)	(11-10)	(9)	(8 - 6)	(5)	(4)	(3-0)

NEW BIT RATE = 000: Low bit rate  
 = 001: Middle bit rate  
 = 010: High bit rate

LB DIS = 1: Disable loopback of input samples  
 = 0: Enable loopback of input samples

GAP = 0: Gap Coding is disabled  
 = 1: Activate Gap Coding

Change compression rate command allows switching between different compression rates. It allows also to enable/disable gap coding codec loopback. This command does not support switching from/to uncompressed speech recording.

#### Status (S2):

0001	REC MODE	TONE GEN	0	STATUS or TAIL CUT FACTOR
(15-12)	(11-10)	(9)	(8)	(7 - 0)

When TONE GEN = 0 and TAIL CUT FACTOR = non zero:

(S2)

MEM FULL	TAIL CUT FACTOR
(7)	(6-0)

In all other cases:

(S2):

MEM FULL	VOX	EXT TONE	TONE	DTMF
(7)	(6)	(5)	(4)	(3-0)

MEM FULL = 1: Memory full condition has been reached.

VOX = 1: Speech frame was detected.

TONE = 1: Call Progress Tone was detected.

DTMF } : Code for Valid DTMF signal detected.

EXT TONE }

## D6571E Data Sheet

### When REC MODE = 01 (Suspend Recording)

**Command (C2):**

0001	01	0	00	0000000
(15-12)	(11-10)	(9)	(8 - 7)	(6 - 0)

**Status (C2):**

0001	01	0	00	0000000
(15-12)	(11-10)	(9)	(8 - 7)	(6 - 0)

### When REC MODE = 11 and TONE GEN = 0 (Read Offset)

**Command (C2):**

0001	11	0	00	0000000
(15-12)	(11-10)	(9)	(8 - 7)	(6 - 0)

**Status (C2):**

0001	11	OFFSET		
(15-12)	(11 - 10)	(9 - 0)		

**Notes:**

The record procedure starts with command C1 and returned status S1. Then Host continuously sends C2 commands. Each command is responded with an S2 status, which includes status information in the STATUS BYTE field. When in Pause the D6571E stays in the Record mode and continues line monitoring, however data is not being stored into the flash memory. Sending C2 command with REC MODE bits 00 (Continue Recording) restores recording process.

Recording mode can be suspended by C2 command with REC MODE = 01. The D6571E terminates recording and goes to Idle mode. After performing another operations (other than recording) recording of the same message can be resumed by sending C1 command with RESUME bit set to "1." Suspended message can be closed by C1 command with CLOSE bit set.

The Record mode continues and monitoring is performed even when memory is full. The Record mode can be terminated with an IDLE command (for 0 tail cut) or with C2 command with a non zero value of the TAIL CUT FACTOR. Status is given once every frame, after receiving the command. When a TAIL CUT command is received, the status is given after the message tail is cut.

# D6571E Data Sheet

## 2. PLAYBACK

### Command (C1):

0010	00	FLEXI SPEED	MESSAGE NUMBER
(15 - 12)	(11-10)	(9 - 7)	(6 - 0)

FLEXI SPEED:	= 000	1.0
	= 001	0.5
	= 010	0.7
	= 011	1.0
	= 100	1.3
	= 101	1.5
	= 110	1.75
	= 111	2.0

### Status (S1):

0010	00	FLEXI SPEED	MESSAGE NUMBER
(15 - 12)	(11 - 10)	(9-7)	(6 - 0)

### Command (C2):

0010	00	OFFSET
(15 - 12)	(11 - 10)	(9 - 0)

OFFSET is defined in units.

For 8 KHz sampling frequency unit is 0.64 sec for TrueSpeech messages and 0.93 sec for PCM messages.

For 7.2 KHz sampling frequency unit is 0.704 sec for TrueSpeech messages and 1.03 sec for PCM messages.

### Status (S2):

0010	00	OFFSET
(15 - 12)	(11 - 10)	(9 - 0)

### Command (C3):

0010	PAUSE	READ OFFSET	FLEXI SPEED	00000
(15 - 12)	(11)	(10)	(9 - 7)	(6 - 0)

PAUSE	= 0:	Continue Playback
	= 1:	Pause.

READ OFFSET = 1: Read current OFFSET from the beginning of the message

## D6571E Data Sheet

**Status (S3): (READ OFFSET = 1)**

0010	PAUSE	1	OFFSET						
(15 - 12)	(11)	(10)	(9 - 0)						

**Status (S3): (READ OFFSET = 0)**

0010	PAUSE	0	BIN	0	END OF PLAY	0	EXT TONE	TONE	DTMF
(15 - 12)	(11)	(10)	(9)	(8)	(7)	(6)	(5)	(4)	(3 - 0)

BIN = 0: Voice Message  
 = 1: Binary Message

END OF PLAY = 1: End of message reached.

TONE = 1: Call Progress Tone detected.

DTMF: } : Code of valid DTMF signal detected.  
 EXT TONE }

### Notes:

Play mode starts with C1 and the returned status S1. The second command, C2, sets OFFSET from the beginning of the message. Actual playback starts after returning the S2 status. From then on, continuous monitoring may be done, using command C3. Status is returned each frame, after the command is recognized. Setting PAUSE to '1' stops the playback. Playback is resumed when PAUSE is reset to '0'. Play mode is continued, and status is reported even when the system is in PAUSE, or when end of message has been reached (END OF PLAY = 1). Play mode is terminated with an IDLE command.

If the host sends the command to playback binary message, the D6571E will play silence and return BIN bit and END of PLAY bit set to "1."

## D6571E Data Sheet

### 3. READ MEMORY STATUS

**Command:**

0011	MODE	0000000000
(15 - 12)	(11-10)	(9 - 0)

MODE = 00: Get memory status  
 = 01: Get product number  
 = 10: Reserved  
 = 11: Reserved

#### MODE 00

**Command:**

0011	0000	VP CHK DIS	0000000
(15 - 12)	(11-8)	(7)	(6 - 0)

VP CHK DIS = 0: Checksum of the Voice Prompt is calculated  
 = 1: Voice Prompt checksum calculation is disabled

**“Warm start”:**

**Status:**

0011	VOICE PROMPT STATUS	0	PROGRAM ROM STATUS	GARBAGE COLLECTION RECOMMENDED	MEMORY FULL	# OF MESSAGES
(15-12)	(11)	(10)	(9)	(8)	(7)	(6 - 0)

VOICE PROMPT STATUS = 0: All activated Voice Prompts are OK or Voice Prompt checksum calculation is disabled.  
 = 1: At least one of the activated Voice Prompt ROMs is not good or not installed or no Voice Prompt ROM is activated in the system

PROGRAM ROM STATUS = 0: ROM Test OK.  
 = 1: ROM Test failed.

GARBAGE COLLECTION = 1: When tel. number directory was reprogrammed, message(s) RECOMMENDED were deleted or not saved, or when Tail Cut was performed. Will be reset after Garbage Collection.

MEMORY FULL = 1: Flash memory is full, or message directory is full

**“Cold start”:**

**Status:**

0000	VOICE PROMPT STATUS	0	PROGRAM ROM STATUS	0	0	0000000
(15-12)	(11)	(10)	(9)	(8)	(7)	(6 - 0)

## D6571E Data Sheet

PROGRAM ROM STATUS = 0: ROM Test OK.  
= 1: ROM Test failed

VOICE PROMPT STATUS = 0: External Voice Prompt is OK or Voice Prompt checksum calculation is disabled.  
= 1: External Voice Prompt ROMs is not good or not installed or no Voice Prompt ROM is activated in the system

### MODE 01:

*Status:*

DIGIT 1	DIGIT 2	DIGIT 3	DIGIT 4
(15 - 12)	(11 - 8)	(7 - 4)	(3 - 0)

DIGIT 1..4 in MODE 01: 4 digit Product No = 6571 (0110 0101 0111 0001)

# D6571E Data Sheet

## 4. WRITE TELEPHONE NUMBER

*Command (C1):*

0100	STORAGE TYPE	ADDRESS
(15 - 12)	(11 - 10)	(9 - 0)

STORAGE TYPE	Mode
00	Telephone Number Storage
01	Non-Erasable Storage
10	Host Configurable General Purpose Storage
11	Reserved

**If STORAGE TYPE = 00 (Telephone Number Storage)**

*Command (C1):*

0100	000	DIRECTORY INDEX	WORD INDEX
(15 - 12)	(11 - 9)	(8 - 2)	(1 - 0)

DIRECTORY INDEX: Telephone number index (0-127)

WORD INDEX: 4 digit group index (0-3)

*Status (S1):*

0100	DIRECTORY FULL	00	DIRECTORY INDEX	WORD INDEX
(15 - 12)	(11)	(10 - 9)	(8 - 2)	(1 - 0)

**DIRECTORY IS FULL:** If this bit is set to 1, the D6571E will go to Idle mode after sending this status, without waiting for the next programming command (C2). This bit will be set when words have been programmed too many times without applying Garbage Collection. This bit should be cleared after running Garbage Collection.

*Command (C2):*

DIGIT 1	DIGIT 2	DIGIT 3	DIGIT 4
(15 - 12)	(11 - 8)	(7 - 4)	(3 - 0)

*Status (S2):*

DIGIT 1	DIGIT 2	DIGIT 3	DIGIT 4
(15 - 12)	(11 - 8)	(7 - 4)	(3 - 0)

## D6571E Data Sheet

### If STORAGE TYPE = 01 (Non-Erasable Storage)

#### Command (C1):

0100	0	1	DIRECTORY INDEX	WORD INDEX
(15 - 12)	(11)	(10)	(9 - 2)	(1 - 0)

DIRECTORY INDEX: Directory index (0-200)

WORD INDEX: Word index (0-3)

**Data can be written to this storage once only and can not be erased or modified.**

#### Status (S1):

0100	DIRECTORY FULL	1	DIRECTORY INDEX	WORD INDEX
(15 - 12)	(11)	(10)	(9 - 2)	(1 - 0)

DIRECTORY FULL = 1: Specified word has been programmed already. The D6571E will go to Idle mode without waiting for C2 command.

#### Command (C2):

DATA				
(15 - 0)				

#### Status (S2):

ECHO of DATA				
(15 - 0)				

### If STORAGE TYPE = 10 (General Purpose Storage)

#### Command (C1):

0100	1	0	ERASE SECTOR	0000	SECTOR NUMBER
(15 - 12)	(11)	(10)	(9)	(8 - 5)	(4 - 0)

ERASE SECTOR = 1: The whole sector will be erased. The D6571E will go to Idle mode after executing this command.

= 0: Command defines the sector number that will be accessed by further commands

SECTOR NUMBER = from 0 to 16. Defines the sector number to be erased or to be accessed by further commands

#### IF ERASE SECTOR = 1

#### Status (S1):

0100	1	0	1	0	BAD SECTOR	000	SECTOR NUMBER
------	---	---	---	---	------------	-----	---------------



## D6571E Data Sheet

(15 - 12)            (11)            (10)            (9)            (8)            (7)            (6 - 5)            (4 - 0)

BAD SECTOR = 0:        Sector OK  
                  = 1:        Sector doesn't exist

### IF ERASE SECTOR = 0

#### Status (S1):

0100	1	0	0	0	BAD SECTOR	00	SECTOR NUMBER
(15 - 12)	(11)	(10)	(9)	(8)	(7)	(6 - 5)	(4 - 0)

BAD SECTOR = 0:        Sector OK  
                  = 1:        Sector doesn't exist/not initialized. The D6571E will go to Idle if sector does not exist.  
                                  See Self-Test & Initialization command for details of General Purpose Storage Initialization.

#### Command (C2):

0100	1	DIRECTORY INDEX				WORD INDEX
(15 - 12)	(11)	(10 - 2)				(1 - 0)

DIRECTORY INDEX: Directory index (0-400)  
 WORD INDEX:        Word index (0-3)

#### Status (S2):

0100	DIR FULL	DIRECTORY INDEX				WORD INDEX
(15 - 12)	(11)	(10 - 2)				(1 - 0)

DIRECTORY FULL = 1:        This bit will be set if words in the Sector has been reprogrammed too many times without applying GC or if Directory Index is greater than 400.

#### Command (C3):

DATA						
(15 - 0)						

#### Status (S3):

ECHO of DATA						
(15 - 0)						

Note: **Garbage Collection must be run prior and after executing Write to GPS.** Read Memory Status command should be sent by Host. Then Garbage Collection should be performed if recommended. The same should be done after writing data to General Purpose Storage.

# D6571E Data Sheet

## 5. READ TELEPHONE NUMBER

0101	STORAGE TYPE	ADDRESS
(15 - 12)	(11 - 10)	(9 - 0)

STORAGE TYPE	Mode
00	Telephone Number Storage
01	Unerasable Storage
10	Host Configurable General Purpose Storage
11	Reserved

### If STORAGE TYPE = 00 (Telephone Number Storage)

*Command (C1):*

0101	000	DIRECTORY INDEX	WORD INDEX
(15 - 12)	(11 - 9)	(8 - 2)	(1 - 0)

DIRECTORY INDEX: Telephone number index (0-127)

WORD INDEX: 4 digit group index (0-3)

*Status (S1):*

DIGIT 1	DIGIT 2	DIGIT 3	DIGIT 4
(15 - 12)	(11 - 8)	(7 - 4)	(3 - 0)

### If STORAGE TYPE = 01 (Non-Erasable Storage)

*Command (C1):*

0101	0	1	DIRECTORY INDEX	WORD INDEX
(15 - 12)	(11)	(10)	(9 - 2)	(1 - 0)

DIRECTORY INDEX: Directory index (0-200)

WORD INDEX: Word index (0-3)

*Status (S1):*

ECHO of DATA
(15 - 0)

## D6571E Data Sheet

### If STORAGE TYPE = 10 (General Purpose Storage)

#### Command (C1):

0101	1	0	0	0000	SECTOR NUMBER
(15 - 12)	(11)	(10)	(9)	(8 - 5)	(4 - 0)

SECTOR NUMBER = from 0 to 16. Defines the sector number to be erased or to be accessed by further commands

#### Status (S1):

0101	1	0	0	0	BAD SECTOR	00	SECTOR NUMBER
(15 - 12)	(11)	(10)	(9)	(8)	(7)	(6 - 5)	(4 - 0)

BAD SECTOR = 0: Sector OK  
 = 1: Sector doesn't exist/not initialized. The D6571E will go to Idle if sector does not exist.  
 See Self-Test & Initialization command for details of General Purpose Storage Initialization.

#### Command (C2):

0101	1	DIRECTORY INDEX	WORD INDEX
(15 - 12)	(11)	(10 - 2)	(1 - 0)

DIRECTORY INDEX: Directory index (0-400)  
 WORD INDEX: Word index (0-3)

#### Status (S2):

DATA
(15 - 0)

## D6571E Data Sheet

### 6. TONE GENERATION

**Command:**

0110	00	0	MASTER GAIN	TONE INDEX
(15-12)	(11 - 10)	(9)	(8-5)	(4-0)

TONE INDEX - defines the Tone Index to be generated according to the table mentioned above.

MASTER GAIN - defines the master gain of this tone. The actual gain will be from -24 dB (gain code 1111) to +6 dB (gain code 0000). The gain code equals:  $0 \leq (\text{GainX} + \text{MASTER GAIN}) \leq 15$

Where GainX (X=0,1) has either the default value (for indexes 0 to C) or a value defined by a New Tone Definition command (indexes from D to 1F). The default value of Gain0 is 1 and the default value of Gain1 is 0.

To continue to generate the same tone and monitor the line, the same command should be issued every frame. To change either tone or gain on the fly, a new TONE INDEX or a MASTER GAIN should be sent in the command. An IDLE command terminates Tone Generation mode.

**Status:**

0110	0000000	EXT TONE	TONE	DTMF
(15-12)	(11-6)	(5)	(4)	(3-0)

TONE = 1: Call Progress Tone detected.

DTMF } : Code of Valid DTMF signal detected.  
EXT TONE }

In case of “warm start” 13 pre-defined tones (including 12 DTMF tones) can be generated from the table provided in the D6571E. The remaining 19 entries are user defined and may be programmed one time. See “New Tone Initialization” below.

“Warm Start” table

Tone Index	DTMF code	Freq 0	Freq 1
0	No Tone		
1	1	697	1209
2	2	697	1336
3	3	697	1477
4	4	770	1209
5	5	770	1336
6	6	770	1477
7	7	852	1209
8	8	852	1336
9	9	852	1477
A	*	941	1209
B	0	941	1336
C	#	941	1477
D - 1F	User Defined Tones		

## D6571E Data Sheet

In case of “cold start” the D6571E allows generation of the following 16 DTMF tones. No user defined tones is available in case of “cold start.”

“Cold Start” table

<b>Tone Index</b>	<b>DTMF code</b>	<b>Freq 0</b>	<b>Freq 1</b>
0	No Tone		
1	1	697	1209
2	2	697	1336
3	3	697	1477
4	4	770	1209
5	5	770	1336
6	6	770	1477
7	7	852	1209
8	8	852	1336
9	9	852	1477
A	*	941	1209
B	0	941	1336
C	#	941	1477
D	A	697	1633
E	B	770	1633
F	C	852	1633
10	D	941	1633

## D6571E Data Sheet

### NEW TONE INITIALIZATION

The D6571E allows definition of tones 13-31 in the table. Tones can be programmed one time from the IDLE mode. The Host can do this by using a sequence of four Tone Initialization commands. These commands can define gain and/or frequency for positions 13 - 31 in the tone generation table (Indexes D - 1F). This command is available in case of “warm start” only.

**Command (C1):**

0110	10	00000	TONE INDEX
(15-12)	(11-10)	(9-5)	(4-0)

TONE INDEX - defines the table entry that will be redefined.

**Status (S1):**

0110	10	00	ENTRY NOT FREE	00	TONE INDEX
(15-12)	(11-10)	(9-8)	(7)	(6-5)	(4-0)

ENTRY NOT FREE - Will be set to “1” if the actual entry was previously programmed. If this is the case, the D6571E will return to IDLE mode after sending this status without waiting for the next programming command (C2).

**Command (C2):**

0110	00	00	GAIN 1	GAIN 0
(15-12)	(11-10)	(9-8)	(7-4)	(3-0)

GAIN - defines gain of the tone.

**Status (S2):**

0110	00	00	GAIN 1	GAIN 0
(15-12)	(11-10)	(9-8)	(7-4)	(3-0)

**Command (C3):**

FREQUENCY FACTOR FOR TONE #0
( 15 - 0 )

**Status (S3):**

FREQUENCY FACTOR FOR TONE #0
( 15 - 0 )

## D6571E Data Sheet

### Command (C4):

FREQUENCY FACTOR FOR TONE #1
------------------------------

( 15 - 0 )

### Status (S4):

FREQUENCY FACTOR FOR TONE #1
------------------------------

( 15 - 0 )

After new tone definition has been made in the table, any of the new defined tones can be generated in the usual way.

## FSK Modem

This mode allows support of the CID function, a-5, as well as general purpose FSK receive and transmit mode with optional HDLC framing and optional RS-232 encapsulation.

### Command (C1):

0110	00	1	NO CS	Master Gain	FSK Configuration
(15 - 12)	(11 - 10)	(9)	(8)	(7 - 4)	(3 - 0)

FSK Config = 0000: FSK Transmit first, FSK Receive second  
 = 0001: FSK Transmit only  
 = 0010: FSK Receive only  
 = 0011: FSK Receive first, FSK Transmit second

Master Gain - Defines the master gain of Transmission. The actual gain will be from -24 dB (gain code 1111) to +6 dB (gain code 0000). The gain code equals:  $0 \leq (\text{GainX} + \text{MASTER GAIN}) \leq 15$

NO CS = 1: FSK (CID) detector does not expect Channel Seizure signal  
 = 0: FSK (CID) detector expects Channel Seizure signal prior message

#### Notes:

- Command C2 - C5 are setup commands. For Receive Only mode value of the C2 - C5 commands are not important. Host can send, for example, Idle commands.
- The order of Receive Command (C7) and Transmit Command (C6) depends on the FSK Configuration. For "Transmit before Receive" mode C7 command will precede C6.

### Status (S1):

0110	0	HDLC	1	NO CS	0000	FSK Configuration
(15 - 12)	(11)	(10)	(9)	(8 - 4)	(3 - 0)	

## D6571E Data Sheet

### Set Number of Leading Mark Bits

#### Command (C2):

Number of Leading Mark Bits
-----------------------------

(15 – 0)

#### Status (S2):

Echo: Number of Leading Mark Bits
-----------------------------------

(15 – 0)

### Set Number of Trailing Mark Bits

#### Command (C3):

Number of Trailing Mark Bits
------------------------------

(15 – 0)

#### Status (S3):

Echo: Number of Trailing Mark Bits
------------------------------------

(15 – 0)

### RS232 and HDLC Configuration

#### Command (C4):

Number of Stop bits	Number of Start bits	0 0 0 0 0 0 0	CRC Swap	CRC Order	CRC Invert	CRC Dir	CRC Init Value
(15 – 14)	(13 - 12)	(11 - 5)	(4)	(3)	(2)	(1)	(0)

CRC Init Value = 0: 0000  
(Initial value of the CRC Register) = 1: FFFF

CRC Dir = 0: LSB first  
(Feeding order of input bytes to CRC) = 1: MSB first

CRC Invert = 0: not inverted  
(Invert CRC checksum before Tx) = 1: inverted

CRC Order = 0: LSBit first  
(CRC Tx bit order) = 1: MSBit first

CRC Swap = 0: Not swapped  
(Swap CRC bytes order) = 1: Swapped

For CID detection the default values: Number of Stop bits = 1



## D6571E Data Sheet

Number of Start bits = 1

### Status (S4):

Number of Stop bits	Number of Start bits	0000000	CRC Swap	CRC Order	CRC Invert	CRC Dir	CRC Init Value
(15 - 14)	(13 - 12)	(11 - 5)	(4)	(3)	(2)	(1)	(0)

### Number of bytes in Frame

#### Command (C5):

0110	Number of Bytes in Frame
(15 - 12)	(11 - 0)

#### Status (S5):

0110	Number of Bytes in Frame
(15 - 12)	(11 - 0)

At this point Transmit or Receive command should be sent to start actual data receive/transmit

### Transmit Command

#### Command (C6):

0110	0	CODE	BYTE (for Load Byte Command) or 00000000 for other modes
(15 - 12)	(11)	(10 - 8)	(7 - 0)

- CODE = 000: Monitoring Command  
 = 001: Load Byte to FIFO  
 = 010: Reset FIFO (Clean Tx FIFO)  
 = 011: Start Generation (start leading mark bits generation)  
 = 100: Stop Generation (stop data generation, start mark bit generation and Receiving data)

Note: C6 command can be sent during data stream or mark bit generation without interrupting the mode. If an Idle command received instead C6 command the FSK mode will terminated.

Upon receiving Stop Generation command the DSP should stop generating data from the FIFO (upon completion of the current byte) and start mark bits generation.

#### Status (S6):

0110	RECEIVE	READY	Number of bytes in the FIFO
(15 - 12)	(11)	(10)	(9 - 0)

- READY = 1: Frame generation is complete. The D6571E started generating trailing "mark" bits.  
 RECEIVE = 1: Trailing "mark" bits generation is complete. The D6571E is in Receive mode.

## D6571E Data Sheet

If transmit FIFO is empty, mark bits will be generated. During mark bits generation the host may send load data command or monitoring command. Idle command will terminate mode.

### **Transmit**

Upon getting Start Generation command the DSP will start generating Mark bits according to the value set by the Set Number of Leading bits command above. Some default value should be set (for example, 300 as required for CID). During mark bits generation the host may send load data command or monitoring command. Idle command will terminate mode. Data to Tx FIFO can be loaded before Start Generation command is received or after Start Generation command. If Tx FIFO is empty “mark” bits will be generated.

After generating “Number of Bytes in Frame” bytes the DSP will start generating trailing mark bits sequence. At this moment the DSP will set bit READT to “1.” The number of trailing mark bits is defined by the Set Number of Trailing bits command. At the same time the DSP goes to receive mode and prepares input buffers for data reception.

After mark bits generation is complete, the DSP sets RECEIVE bit in the status word to ‘ 1.’

### **Receive after Transmit**

The DSP will start accumulating input data immediately after it completes mark bits generation (data accumulated in the input buffers during mark bits generation will not be processed). The DSP will stay in the FSK Receive mode at least until next host command is received.

Normally the Host can not send Idle command during trailing mark bits generation because Idle command will terminate mode immediately. Idle command can be sent only after RECEIVE bit is high .

This means that transition from FSK Transmit to FSK Receive mode will be performed without going via Idle mode.

### **Receive Command**

#### **Command (C7):**

0110	1	CODE	00000000
(15 – 12)	(11)	(10 – 8)	(7 – 0)

CODE = 000: Monitoring Command  
 = 001: Move Received Byte to Host  
 = 010: Monitor Received Mark Bits (before first data byte)  
 = 011: Reset FIFO (Clean Rx FIFO)  
 = 100: HDLC Monitoring  
 = 101: Monitor Received Channel Seizure signals (before first data byte)  
 = 110: Reserved  
 = 111: Stop Receiving Data. The DSP will go to Idle Mode or FSK Transmit according to C1.

- C7 Command will be sent during FSK data Receive.

Note: C7 command can be sent during data stream or mark bit detection without interrupting the mode. If an Idle command received instead C7 command the FSK Receive mode will terminated and the DSP will go to Idle Mode.

## D6571E Data Sheet

### Monitoring Command

#### Command (C7):

0110	1	000	00000000
(15 - 12)	(11)	(10 - 8)	(7 - 0)

#### Status (S7):

0110	1	0	Number of bytes in the FIFO
(15 - 12)	(11)	(10)	(9 - 0)

### Move Received Byte to Host

#### Command (C7):

0110	1	001	00000000
(15 - 12)	(11)	(10 - 8)	(7 - 0)

#### Status (S7):

0110	0	00	ND	DATA BYTE
(15 - 12)	(11)	(10 - 9)	(8)	(7 - 0)

ND = 0: Data Byte Detected  
 = 1: No Data Byte Detected (DATA BYTE = 00H)

### Monitor Received Mark Bits

#### Command (C7):

0110	1	010	00000000
(15 - 12)	(11)	(10 - 8)	(7 - 0)

#### Status (S7):

0110	1	Current Number of Received Mark Bits
(15 - 12)	(11)	(10 - 0)

### Reset FIFO

#### Command (C7):

0110	1	011	00000000
(15 - 12)	(11)	(10 - 8)	(7 - 0)

## D6571E Data Sheet

### Status (S7):

0110	1	00000000		
(15 - 12)	(11)	(10 - 0)		

### HDLC Monitoring

#### Command (C7):

0110	1	1 0 0	00000000	
(15 - 12)	(11)	(10 - 8)	(7 - 0)	

#### Status (S7):

0110	0	00000000	CRC Error	Frame Ready
(15 - 12)	(11)	(10 - 2)	(1)	(0)

Frame Ready = 1: Frame is received, CRC result is ready  
 = 0: Frame is not received yet

CRC Error = 1: CRC Checksum is incorrect  
 = 0: CRC Checksum is correct

### Monitor Channel Seizure Signal

#### Command (C7):

0110	1	1 0 1	00000000	
(15 - 12)	(11)	(10 - 8)	(7 - 0)	

#### Status (S7):

0110	1	Current Number of Received Channel Seizure Bits		
(15 - 12)	(11)	(10 - 0)		

### Stop Receiving Data

#### Command (C7):

0110	1	1 1 1	00000000	
(15 - 12)	(11)	(10 - 8)	(7 - 0)	

#### Status (S7):

## D6571E Data Sheet

0110	1	000000000
(15 - 12)	(11)	(10 - 0)

### 7. LINE MONITOR

**Command:**

0111	0	CID	0	NO CS	00	LB DIS	00000
(15 - 12)	(11)	(10)	(9)	(8)	(7 - 6)	(5)	(4 - 0)

CID = 0: Line Monitor Mode  
 = 1: CID demodulation

LB DIS = 1: Disable loopback of input samples  
 = 0: Enable loopback of input samples

NO CS = 1: CID detector does not expect Channel Seizure signal (off-hook BellCore protocol)  
 = 0: CID detector expects Channel Seizure signal prior message (on-hook BellCore, V.23)

**If CID = 0**

**Status:**

0111	000000	EXT TONE	TONE	DTMF
(15 - 12)	(11 - 6)	(5)	(4)	(3 - 0)

TONE = 1: Call progress tone detected.  
 DTMF } : Code of Valid DTMF signal detected.  
 EXT TONE }

**Note:**

Status is returned after recognizing the command, in each frame. Line monitoring is ended by an IDLE command.

**If CID = 1**

**Status:**

0111	000	ND	CID BYTE
(15 - 12)	(11 - 9)	(8)	(7 - 0)

CID BYTE: ASCII byte of a CID information.

ND = 0: CID Byte Detected  
 = 1: no CID Byte is detected (CID Byte = 00H in this case)

The Command / Status sequence should be repeated until the entire CID message is received. An average rate is 3-4 command/status sequences per frame when the CID data is being detected. If the D6571E does not detect CID information during last full frame the D6571E will return status with ND bit set. In case of no detection the command/status rate is 1 per frame. CID byte = 00H in case of no detection. When NO CS bit is set the D6571E performs CID detection according to the BellCore off-hook protocol (detection of the Seizure Signal is not required), while if NO CS bit is 0 the D6571E expects

## D6571E Data Sheet

detection of the Seizure Signal (V.23 and on-hook Bell 202 protocol).

### 8. DELETE MESSAGE

**Command:**

1000	GC	ERASE	000	MESSAGE NUMBER
(15 - 12)	(11)	(10)	(9-7)	(6 - 0)

GC = 0: Delete message defined by MESSAGE NUMBER  
 = 1: Perform Garbage Collection (MESSAGE NUMBER is not relevant)  
 ERASE = 1: Erase entire flash including Voice Prompt

**IF GC = 0, ERASE = 0**

**Status:**

1000	0	000	E	MESSAGE NUMBER
(15-12)	(11)	(10-8)	(7)	(6 - 0)

E = 0: Indicates valid message.  
 = 1: Indicates non-valid message.

**IF GC = 1, ERASE = 0**

**Status:**

1000	1	000	E	000000	COLD START
(15-12)	(11)	(10-8)	(7)	(6 - 1)	(0)

E = 0: Sectors have been erased (not the last one).  
 = 1: The last sector was erased (procedure has been completed).

COLD START = 0: "Warm Start"  
 = 1: "Cold Start" - Flash should be initialized before being accessed.

In case of Garbage Collection, the status is sent when the procedure has completed erasing sector. Idle is automatically resumed after the sector erase. The Garbage Collection erases one sector per command. As a general procedure the Host should send Garbage Collection commands until all sector are erased. If this is the last sector (or no sectors has to be erased) the E status bit is 1. Garbage Collection is stopped automatically upon detection of a Power Down condition.

**IF ERASE = 1**

**Status:**

1000	0	1	0000000000
(15 - 12)	(11)	(10)	(9 - 0)

To perform erase of the entire flash the command 8400H should be sent twice. In response to each command the D6571E

## D6571E Data Sheet

will return status 8400H. The erase operation will be performed upon receiving the second Erase command. The second status will be returned upon completion of the erase operation. The erase operation can be performed in case of “cold” and in case of “warm start.”

**The Erase operation must NOT be performed on the flash that has been never initialized.**

### 9. SET/MODIFY TIME STAMP

Allows storage of two words associated with the next recorded message.

#### *Command (C1):*

1001	WORD NUMBER	MODIFY	0 0 0	MESSAGE NUMBER
(15 - 12)	(11)	(10)	(9 - 7)	(6 - 0)

WORD NUMBER = 0: Set first word  
= 1: Set second word

MODIFY = 0: Initial setting of the Time Stamp prior recording (MESSAGE NUMBER - don't care, Time Stamp will be attached to the next recorded message)  
= 1: Modify Time Stamp after message has been recorded (MESSAGE NUMBER - specifies the number of the message the Time Stamp attached to)

#### *Status (S1):*

1001	WORD NUMBER	MODIFY	0 0 0	MESSAGE NUMBER
(15 - 12)	(11)	(10)	(9 - 7)	(6 - 0)

#### *Command (C2):*

TIME STAMP
(15 - 0)

#### *Status (S2):*

TIME STAMP
(15 - 0)

Note: The Modify Time Stamp command allows modification of any bit of the Time Stamp from 1 to 0. No modification from 0 to 1 is allowed. Therefore it is recommended to set all unused bits to 1 by the Set Time Stamp command.

### 10. GET TIME STAMP

#### *Command:*

1010	WORD NUMBER	0 0 0 0	MESSAGE NUMBER
(15 - 12)	(11)	(10 - 7)	(6 - 0)

## D6571E Data Sheet

WORD NUMBER = 0: Get first word  
= 1: Get second word

*Status:*

TIME STAMP
------------

(15 - 0)



## D6571E Data Sheet

### 11. GET AVAILABLE RECORD TIME

**Command:**

1011	000000000000
(15 - 12)	(11 - 0)

**Status:**

1011	AVAILABLE TIME
(15 - 12)	(11 - 0)

AVAILABLE TIME: Available time in units of 0.833 seconds for high bit rate without gap coding and 8 KHz sampling rate (1.111 seconds for mid bit rate without gap coding; 1.82 seconds for low bit rate without gap coding). For 7.2 KHz sampling rate the value of the unit is 10% higher for each compression rate.

### 12. SELF TEST AND INITIALIZATION

**Command (General):**

1100	TEST MODE	TEST/INITIALIZATION PARAMETERS
(15-12)	(11 - 8)	(7 - 0)

TEST MODE = 0001: Flash Initialization  
 = 0011: Flash Fast Self-Test  
 = 0100: CODEC Hardware Selection  
 = 0101: Flash Hardware Selection  
 = 0110: CODEC Loopback  
 = 0111: Algorithm Co nfiguration  
 = 1000: Volume Control  
 = 1001: Storage Configuration  
 = 1010: Program Sensitivity  
 = 1011: GPIO access  
 = 1100: Reserved  
 = 1101: Reserved

## D6571E Data Sheet

### TEST MODE = 0001 (Flash Initialization)

#### Command:

1100	0001	Flash Size	0	DEVICE 3	DEVICE 2	DEVICE 1	DEVICE 0
(15 - 12)	(11-8)	(7-5)	(4) (3)	(2) (1)	(0)		

Flash Size = 0: 4 Mbit  
 (Size of one flash device) = 1: Reserved  
 = 2: Reserved  
 = 3: 16 Mbit

DEVICE 0 .. 3 = 1: Device is installed  
 (For Flash Size 0) = 0: Device is not installed

DEVICE 0 = 1: Device is installed  
 (For Flash Size 3) = 0: Device is not installed  
 DEVICE 1,2,3 = Don't care

#### Status:

1100	0001	Flash Size	0	DEVICE 3	DEVICE 2	DEVICE 1	DEVICE 0
(15 - 12)	(11-8)	(7-5)	(4) (3)	(2) (1)	(0)		

Flash Size = 0: 4 Mbit  
 (Size of one flash device) = 1: Reserved  
 = 2: Reserved  
 = 3: 16 Mbit

DEVICE 0 .. 3 = 0: Device is good  
 (For Flash Size 0) = 1: Device is not installed or bad

DEVICE 0 = 0: Device is good  
 (For Flash Size 3) = 1: Device is not installed or bad  
 DEVICE 1,2,3 = 1

### TEST MODE = 0011 (Flash Fast Self Test):

#### Command:

1100	0011	Flash Size	0	DEVICE 3	DEVICE 2	DEVICE 1	DEVICE 0
(15 - 12)	(11-8)	(7-5)	(4) (3)	(2) (1)	(0)		

Flash Size = 0: 4 Mbit  
 (Size of one flash device) = 1: Reserved  
 = 2: Reserved  
 = 3: 16 Mbit

DEVICE 0 .. 3 = 1: Device is installed  
 (For Flash Size 0) = 0: Device is not installed

DEVICE 0 = 1: Device is installed  
 (For Flash Size 3) = 0: Device is not installed

## D6571E Data Sheet

DEVICE 1,2,3 = Don't care

### Status:

1100	0011	Flash Size	0	DEVICE 3	DEVICE 2	DEVICE 1	DEVICE 0
(15 - 12)	(11-8)	(7-5)	(4)	(3)	(2)	(1)	(0)

Flash Size = 0: 4 Mbit  
 (Size of one flash device) = 1: Reserved  
 = 2: Reserved  
 = 3: 16 Mbit

DEVICE 0 .. 3 = 0: Device is installed  
 (For Flash Size 0) = 1: Device is not installed or bad

DEVICE 0 = 0: Device is installed  
 (For Flash Size 3) = 1: Device is not installed or bad  
 DEVICE 1,2,3 = 1

### TEST MODE = 0101 (Flash Hardware Selection)

#### Command:

1100	0101	E/VP	# of VP ROM	00	Flash Type
(15 - 12)	(11-8)	(7)	(6-4)	(3-2)	(1-0)

Flash Type = 01: Toshiba  
 = 10: Samsung

E/VP = 1: External VP ROM is used (available only in the case of one 4 Mbit flash device or no flash)  
 = 0: Internal (on flash) VP area is used

# of VP ROM installed = 000: No VP  
 = 001: One VP sector  
 = 010: Two VP sectors  
 = 011: Three VP sectors  
 = 100: Four VP sectors

### Status:

1100	0101	E/VP	# of VP ROM	00	Flash Type
(15 - 12)	(11-8)	(7)	(6-4)	(3-2)	(1-0)

## D6571E Data Sheet

### TEST MODE = 0100 (Codec Hardware Selection)

**Command:**

1100	0100	SAMP	M/S	CODEC TYPE	OUTPUT CODEC	INPUT CODEC	LAW	0
(15-12)	(11-8)	(7)	(6)	(5)	(4-3)	(2)	(1)	(0)

SAMP = 1: 8 KHz sampling rate (Default)  
 = 0: 7.2 KHz sampling rate

M/S = 0: Master mode  
 = 1: Slave mode (Default)

CODEC TYPE = 0: Fixed mode (TI codec) (Default)  
 = 1: Variable mode (OKI codec)

INPUT CODEC = 0: Input data will be read from codec 0. In the SpeakerPhone mode both codec are used (Default).  
 This setting should be used in the SpeakerPhone mode and while taking signal from the telephone line.  
 = 1: Input data will be read from codec 1.

OUTPUT CODEC = 00: Output data will be written to CODEC0 in all the modes except SpeakerPhone.  
 In the SpeakerPhone mode both codecs are used. CODEC0 is connected to the telephone line and CODEC1 to the speaker. (Default). This mode should be used in the SpeakerPhone mode.  
 = 01: Output data will be written all the time to CODEC1.  
 = 10: Output data will be written all the time to CODEC0.  
 = 11: Output data will be written all the time to both CODECS.

LAW = 0:  $\mu$ -law codec interface (default)  
 = 1: A-law codec interface

**Status:**

1100	0100	SAMP	M / S	CODEC TYPE	OUTPUT CODEC	INPUT CODEC	LAW	0
(15-12)	(11-8)	(7)	(6)	(5)	(4-3)	(2)	(1)	(0)

### TEST MODE = 0110 (CODEC Loopback)

**Command:**

1100	0110	00000000						
(15 - 12)	(11-8)	(7 - 0)						

**Status:**

1100	0110	00000000						
------	------	----------	--	--	--	--	--	--

## D6571E Data Sheet

(15 - 12)

(11-8)

(7 - 0)

Note: The system will continue in CODEC Loopback mode until an Idle command is received.

**TEST MODE = 0111 (ALGORITHM CONFIGURATION)**

**Command:**

1100	0111	Sub Mode	XXXXX	
(15 - 12)	(11 - 8)	(7 - 5)	(4 - 0)	

Sub Mode: = 000: DTMF  
 = 001: CAS configuration  
 = 010: AGC configuration  
 = 011: Filter configuration  
 = 100: FSK Configuration

**Submode = 000 (DTMF)**

**Command:**

1100	0111	000	0000	16 DTMF
(15 - 12)	(11 - 8)	(7 - 5)	(4 - 1)	(0)

16 DTMF = 0: the D6571E reports detection of the 12 DTMF digits  
 = 1: the D6571E reports detection of the 16 DTMF digits

**Status:**

1100	0111	000	0000	16 DTMF
(15 - 12)	(11 - 8)	(7 - 5)	(4 - 1)	(0)

**Submode = 001 (CAS configuration)**

**Command (C1):**

1100	0111	001	0000	0
(15 - 12)	(11 - 8)	(7 - 5)	(4 - 1)	(0)

**Status (S1):**

1100	0111	001	0000	0
(15 - 12)	(11 - 8)	(7 - 5)	(4 - 1)	(0)

**Command (C2):**

CAS LEVEL				
(15 - 0)				

## D6571E Data Sheet

*Status (S2):*

CAS LEVEL
-----------

(15 - 0)

*Command (C3):*

THRESHOLD LEVEL
-----------------

(15 - 0)

*Status (S3):*

THRESHOLD LEVEL
-----------------

(15 - 0)

### Submode = 010 (AGC Configuration)

*Command:*

1100	0111	010	Enable AGC	Parameters	Read/Write	AGC #
(15 - 12)	(11 - 8)	(7 - 5)	(4)	(3)	(2)	(1 - 0)

Enable AGC = 0: Disable AGC  
 = 1: Enable AGC

Parameters	Read/Write	
0	X	Enable/Disables AGC, the DSP enters Idle mode after this command.
1	0	Read Current Value of the parameter.
1	1	Set new values for the all parameters.

AGC # = 00: AGC  
 = Else: Reserved

### If Parameters = 0:

*Command C1:*

1100	0111	010	Enable AGC	0	0	AGC #
(15 - 12)	(11 - 8)	(7 - 5)	(4)	(3)	(2)	(1 - 0)

Enable AGC = 0: Disable AGC  
 = 1: Enable AGC

AGC # = 00: AGC  
 = Else: Reserved

*Status S1:*

1100	0111	010	Enable AGC	0	0	AGC #
------	------	-----	------------	---	---	-------

## D6571E Data Sheet

(15 - 12)      (11 - 8)      (7 - 5)      (4)      (3)      (2)      (1 - 0)

### If Parameters = 1:

#### Command C1:

1100	0111	010	0	1	Read/Write	AGC #
(15 - 12)	(11 - 8)	(7 - 5)	(4)	(3)	(2)	(1 - 0)

Read/Write = 0 : Read Current Value of the parameter.  
 = 1 : Set new values for the all parameters.

AGC # = 00: AGC  
 = Else Reserved

#### Status S1:

1100	0111	010	0	1	Read/Write	AGC #
(15 - 12)	(11 - 8)	(7 - 5)	(4)	(3)	(2)	(1 - 0)

### If Read/Write = 0:

#### Command C2:

1100	0111	0	0	Parameter #	00
(15 - 12)	(11 - 8)	(7)	(6)	(5 - 2)	(1 - 0)

Parameter # = 0000: Optimum Level Eopt.  
 = 0001: Minimum Level Emin.  
 = 0010: Gain Level Eatt  
 = 0011: Silence Level Esil.  
 = 0100: Hold Time  
 = 0101: Decay Time  
 = Else: Reserved

Note: If Idle command will be detected instead of C2 command the DSP will go to Idle mode. After C2 command the D6571E will expect next command which either C1 command (to read another parameter) or Idle command.

#### Status S2:

Parameter Value
-----------------

## D6571E Data Sheet

PARAMETER: Optimum Level Eopt, Minimum Level Emin, Gain Threshold Level Eatt, Silence Level Esil are in [dB].  
Range of values [0, 2, 4, ..., 56] decimal in steps of 2 dB.  
Hold Time Thold in 20 ms units. Range of values [0 .. 32000] Decimal, corresponds to 0 .. 640 sec  
Decay Time Tdecay in 100 ms units. Range of values [0 .. 360], corresponds to 0 .. 36 sec



## D6571E Data Sheet

The actual level of the parameter should be calculated as **(3 dBm - Parameter Value)**

Parameter	Default Parameter Value (decimal representation)	Default Parameter Value (hex representation)	Default Value (physical meaning)
Eopt	4 dB	0004	- 1 dBm*
Emin	22 dB	0016	- 19 dBm*
Eatt	36 dB	0024	- 33 dBm*
Esil	46 dB	002E	- 43 dBm*
Thold	100	0064	2.0 sec
Tdecay	10	000A	1.0 sec

\* - Calculated as (3 - Parameter Value) dBm

### If Read/Write = 1:

If Read/Write = 1 the next 6 commands should contain the values of the main AGC parameters.

First four parameters are in dBs. Decimal representation of the Parameter Value should be calculated as - **(Physical Value - 3)**. Command should contain hex representation of the Parameter Value.

#### Command C2:

Optimum Level Eopt[dB]
------------------------

(0-15)

#### Status S2:

Optimum Level Eopt[dB]
------------------------

(0-15)

#### Command C3:

Minimum Level Emin [dB]
-------------------------

(0-15)

#### Status S3:

Minimum Level Emin[dB]
------------------------

(0-15)

#### Command C4:

Gain Threshold Level Eatt [dB]
--------------------------------

(0-15)

#### Status S4:

Gain Threshold Level Eatt[dB]
-------------------------------

(0-15)

## D6571E Data Sheet

*Command C5:*

Silence Threshold Level Esil[dB]
----------------------------------

(0-15)

*Status S5:*

Silence Threshold Level Esil [dB]
-----------------------------------

(0-15)

*Command C6:*

Hold Time [20ms]
------------------

(0-15)

*Status S6:*

Hold Time [20ms]
------------------

(0-15)

*Command C7:*

Decay Time Tdecay [100 ms]
----------------------------

(0-15)

*Status S7:*

Decay Time Tdecay [100 ms]
----------------------------

(0-15)

### Sub Mode = 011 (Filter Enable/Disable)

*Command C1:*

1100	0111	011	ENABLE	0	0	FILTER #
------	------	-----	--------	---	---	----------

(15 - 12)

(11 - 8)

(7 - 5)

(4)

(3)

(2)

(1 - 0)

HPF Enable = 0: Disable Filter  
 = 1: Enable Filter Encoder (default)

FILTER # = 00: High Pass Filter  
 = Else: Reserved

*Status S1:*

1100	0111	011	ENABLE	0	0	FILTER #
------	------	-----	--------	---	---	----------

(15 - 12)

(11 - 8)

(7 - 5)

(4)

(3)

(2)

(1 - 0)

## D6571E Data Sheet

### Submode = 100 (FSK)

**Command:**

1100	0111	1 0 0	SL	SENSITIVITY LEVEL
(15 - 12)	(11 - 8)	(7 - 5)	(4)	(3 - 0)

**Status:**

1100	0111	1 0 0	SL	SENSITIVITY LEVEL
(15 - 12)	(11 - 8)	(7 - 5)	(4)	(3 - 0)

SENSITIVITY LEVEL	Sensitivity Adjustment (dB)
0000	-32
0001	-33
0010	-34
0011	-35
0100	-36
0101	-37
0110	-38
<b>0111</b>	<b>-39</b>
1000	-40
1001	-41
1010	-42
1011	-43
1100	-44
1101	-45
1110	-46
1111	-47

### TEST MODE = 1000 (Volume Control):

**Command:**

1100	1000	SV	0 0	Volume Level
(15 - 12)	(11-8)	(7)	(6-5)	(4 - 0)

## D6571E Data Sheet

SV - set volume: = 1: set the volume according to the Volume level field  
 = 0: read the current Volume level

Volume Level - set level of the signal playing to the codec. When SV = 1 then volume level is set by DSP according to the table below:

VOLUME LEVEL	Signal level (dB)
00000	+16
00001	+14
00010	+12
00011	+10
00100	+8
00101	+6
00110	+4
00111	+2
<b>01000</b>	<b>0</b>
01001	-2
01010	-4
01011	-6
01100	-8
01101	-10
01110	-12
01111	-14
10000	-16
10001	-18
10010	-20
10011	-22
10100	-24
10101	-26
10110	-28
10111	-30
11000	-32
11001	-34
11010	-36
11011	-38
11100	-40
11101	-42
11110	Mute
11111	Mute

**Status:**

1100	1000	SV	00	Volume level
(15 - 12)	(11-8)	(7)	(6-5)	(4 - 0)

Note: After RESET, the system sets all parameters into default values. Once volume is changed, the system operates with this value until the new "Volume level" command is issued. This command can be issued during "RECORD", "LINE MONITOR", "PLAYBACK", and "VOICE PROMPT" modes without interrupting these modes.

## D6571E Data Sheet

### TEST MODE = 1001 (Storage Configuration):

#### Command (C1):

1100	1001	000	# of GPS Sectors
(15 - 12)	(11 - 8)	(7 - 5)	(4 - 0)

# of GPS sectors = 0: no GPS available (default)  
 = 1 .. 16 defines number of sectors available for GPS

#### Status (S1):

1100	1001	000	# of GPS Sectors
(15 - 12)	(11 - 8)	(7 - 5)	(4 - 0)

### TEST MODE = 1010 (Programmable sensitivity):

#### Command:

1100	1010	SIGNALING SYSTEM SELECTION	SL	SENSITIVITY LEVEL
(15 - 12)	(11 - 8)	(7-6)	(5)	(4 - 0)

SL - set sensitivity level: = 1: set sensitivity level for chosen signaling system according to the sensitivity level field  
 = 0: read the current sensitivity level for chosen signaling system

SIGNALING SYSTEM SELECTION = 00: DTMF detector  
 = 01: VOX detector  
 = 10: Call Progress Tone detector  
 = 11: CAS detector

SENSITIVITY LEVEL	Sensitivity Adjustment (dB)
00000	+6
00001	-14
00010	-12
00011	-10
00100	-8
00101	-6
00110	-4
00111	-2
<b>01000</b>	<b>0</b>
01001	+2
01010	+4

## D6571E Data Sheet

01011	+6
01100	+8
01101	+10
01110	+12
01111	+14
10000	+16
10001	+18
10010	+20
10011	+22
10100	+24
10101	+26
10110	+28
10111	+30
11000	+32
11001	+34
11010	+36
11011	+38
11100	+40
11101	+42
11110	Disabled
11111	Disabled

**Status:**

1100	1010	SIGNALING SYSTEM SELECTION	SL	SENSITIVITY LEVEL
(15 - 12)	(11 - 8)	(7-6)	(5)	(4 - 0)

Note: After RESET, the system sets all parameters into default values. Once sensitivity is changed, the system operates with this value until the new "Programmable sensitivity" command is issued. This command can be issued during "RECORD", "LINE MONITOR", "PLAYBACK", "TONE GENERATION" and "VOICE PROMPT" modes without interrupting these modes.

## D6571E Data Sheet

**TEST MODE = 1011 (GPIO Access)**

**Command (C1):**

1100	1011	WR/RD\	DIR/VALUE\	000000
(15 - 12)	(11 - 8)	(7)	(6)	(5 - 0)

WR = 0: read current setting  
= 1: write new setting

DIR/VALUE = 0: read/write value of the pin  
= 1: read/write configuration of the pin

*Each bit of the C2 command (for WR = 1) and S1 status represents GPIO of the D6571E. The following is a bit assignment of the C2/S1.*

**Bit Assignment:**

0000000000	GPIO					
	5	4	3	2	1	0
(15 - 6)	(5)	(4)	(3)	(2)	(1)	(0)

**WR = 0**

**Command (C1):**

1100	1011	0	DIR/VALUE\	000000
(15 - 12)	(11 - 8)	(7)	(6)	(5 - 0)

**Status (S1):**

D A T A
(15 - 0)

The meaning of the bits in the status S1 depending on the bit DIR/VALUE of the C1 command.

DIR/VALUE\	Meaning of the status bit
0	For pins configured as inputs: = 0: input pin reads low level = 1: input pin reads high level  For pins configured as outputs: = 0: currently pin outputs low level = 1: currently pin outputs high level
1	= 0: currently pin is configured as input = 1: currently pin is configured as output

## D6571E Data Sheet

WR = 1

*Command (C1):*

1100	1011	1	DIR/VALUE\	000000
(15 - 12)	(11 - 8)	(7)	(6)	(5 - 0)

DIR/VALUE = 0: read/write value of the pin  
 = 1: read/write configuration of the pin

*Status (S1):*

1100	1011	WR/RD\	DIR/VALUE\	000000
(15 - 12)	(11 - 8)	(7)	(6)	(5 - 0)

*Command (C2):*

D A T A
(15 - 0)

The meaning of the bits in the command C2 depending on the DIR/VALUE of the C1 command.

DIR/VALUE\	Meaning bits in the C2	Suggested Value
0	For pins configured as inputs: Don't care ----- For pins configured as outputs: = 0: pin will output low level = 1: pin will output high level	0 -----
1	= 0: pin is being configured as input = 1: pin is being configured as output	

*Status (S2):*

D A T A
(15 - 0)



## D6571E Data Sheet

### **13. VOICE PROMPT PLAYBACK**

**Command:**

1101	LOAD	SET SECTOR	FLEXI SPEED	NUMBER
(15 - 12)	(11)	(10)	(9 - 7)	(6 - 0)

LOAD	SET SECTOR	NUMBER	MODE
0	0	xxxx	Voice Prompt Playback / Line Monitor
1	0	Phrase # to load	Load new phrase to play from pre -defined sector
0	1	Sector #	Define sector the next phase will be loaded from
1	1		Program Voice Prompt into the Flash

The default sector is #0. Therefore, to playback from sector 0 no SET SECTOR command is required. To playback from any other sector, the SET SECTOR command is required prior to phrase load. Once the sector has been changed this will remain active until a new SET SECTOR command is issued. In this case, Voice Prompt command with SET SECTOR = 1 and LOAD = 0 should be sent. This command will define new sector number (bits 2..0). Next LOAD command (with LOAD bit = 1) will load the phrase from the new sector.

If both LOAD bit and SET SECTOR bit are set to 1, the D6571E enters Program Voice Prompt mode.

**LOAD and PLAY Voice Prompt mode (SET SECTOR bit = 0)**

**Command:**

1101	LOAD	0	FLEXI SPEED	PHRASE NUMBER
(15 - 12)	(11)	(10)	(9 - 7)	(6 - 0)

LOAD = 1: Load new phrase number for playback  
 = 0: Monitor Status

PHRASE NUMBER: The serial number of the speech phrase located in the EPROM/ROM vocabulary, which is to be played back.

FLEXI SPEED: Same as in the PLAYBACK command.

**Status:**

1101	LOAD	READY	00	END OF PLAY	0	EXT TONE	TONE	DTMF
(15 - 12)	(11)	(10)	(9 - 8)	(7)	(6)	(5)	(4)	(3 - 0)

READY = 1: Ready for loading a new phrase for playback  
 END OF PLAY = 1: End of phrase reached.  
 TONE = 1: Call Progress Tone detected.  
 DTMF } = : Code of valid DTMF signal detected.  
 EXT TONE }

## D6571E Data Sheet

### Note:

A playback sequence starts with a command with LOAD set at 1, and a definition of a PHRASE NUMBER. Status monitoring can be done by issuing command with LOAD set at 0. When READY = 1 is detected, a new phrase can be loaded. To play a sequence of phrases, a new command with LOAD bit set at 1 should be issued after n frames (n=0..X) from the moment READY bit is detected as 1. This will introduce n frame delays between the phrases. The monitoring commands (bit LOAD = 0) may have any number in the PHRASE NUMBER field (for example 0 or the next phrase number to be played). The new phrase number will not be accepted until READ bit has become 1.

END OF PLAY bit indicates that the last frame is going to be played. An IDLE command ends the mode.

**SET SECTOR** (SET SECTOR bit =1, LOAD bit = 0)

### Command:

1101	0	1	FLEXI SPEED	0000	SECTOR NUMBER
(15 - 12)	(11)	(10)	(9 - 7)	(6 - 3)	(2 - 0)

SECTOR NUMBER:      =00:      Selects Voice Prompt Sector # 0 (default)  
                              =01:      Selects Voice Prompt Sector # 1  
                              =10:      Selects Voice Prompt Sector # 2  
                              =11:      Selects Voice Prompt Sector # 3

### Status:

1101	LOAD	READY	00	END OF PLAY	0	0	TONE	DTMF
(15 - 12)	(11)	(10)	(9 - 8)	(7)	(6)	(5)	(4)	(3 - 0)

SET SECTOR command can be sent any time during phrase playback instead of monitoring command. The playback will not be interrupted. The D6571E will return status of the monitoring command. The next phrase will be loaded (by the command with LOAD bit = 1) from the newly defined sector. Sector remains active until another SET SECTOR command is issued. By default SECTOR 0 is active.

SET SECTOR command can be sent from Idle mode. In this case the D6571E activates a new sector, returns echo of the command in the status word, and remains in Idle mode.

## **PROGRAM VOICE PROMPT (SET SECTOR bit = 1, LOAD bit = 1)**

### Command (C1):

1101	11	0	0	00000000
(15 - 12)	(11-10)	(9)	(8)	(7 - 0)

### Status (S1):

1101	11	0	ERROR	00000000
(15 - 12)	(11-10)	(9)	(8)	(7 - 0)

ERROR    =1:    Four Voice Prompt sectors exist already.

## D6571E Data Sheet

### Command (C2):

1101	11	0	0	000	NUMBER OF WORDS
(15 - 12)	(11-10)	(9)	(8)	(7 - 5)	(4 - 0)

### Status (S2):

1101	11	0	ERROR	000	TRANSFER NUMBER OF WORDS
(15 - 12)	(11-10)	(9)	(8)	(7 - 5)	(4 - 0)

ERROR =1: More than 64K were programmed.

### Data Transfer Command: (DC1...DC16)

Voice Prompt Data
(15 - 0)

### Data Transfer Status: (DS1...DS16)

Echo of Voice Prompt Data
(15 - 0)

When Host sends the Voice Prompt command with bits 11 and 10 set to "1" the D6571E enters the Program Voice Prompt mode. The command C1 should be sent only once. Error bit will be sent if two Voice Prompt sectors exist already in the flash.

To program a portion of the Voice Prompt, the HOST sends the C2 command with number of words that Host is going to transmit to the D6571E (usually 16). The D6571E will respond with the status S2 with the number of words that the D6571E will accept (usually 16). Then actual data transfer begins. After loading 16 words of data the Host will send another C2 command to start loading next portion of data.

If more than 64K bytes is loaded the D6571E will set ERROR bit in the S2 status.

## D6571E Data Sheet

### 14. SPEAKER PHONE

#### Command (C1):

1110	R/T RATIO	T/R RATIO	LINE SENSITIVITY	MIC SENSITIVITY	PRIORITY	0
(15 - 12)	(11 - 10)	(9 - 8) (7 - 5)	(4 - 2)	(1)	(0)	

LINE SENSITIVITY: = 000: 2 dB  
 = 001: 4 dB  
 = 010: 6 dB  
 = **011**: **8 dB**  
 = 100: 10 dB  
 = 101: 12 dB  
 = 110: 14 dB  
 = 111: 16 dB

MIC. SENSITIVITY: = 000: 2 dB  
 = 001: 4 dB  
 = **010**: **6 dB**  
 = 011: 8 dB  
 = 100: 10 dB  
 = 101: 12 dB  
 = 110: 14 dB  
 = 111: 16 dB

The line and microphone sensitivity determine the Signal-to-Noise Ratio (SNR) at which the voice detectors for the transmit and receive directions will be activated.

PRIORITY = 0: **No priority**  
 = 1: Near end priority

The priority control is used to determine the behavior of the system when both directions are silent. In the no priority mode, the loop attenuation is distributed equally between the receive and transmit directions when both sides are silent. If the priority bit is set, the line side is given all the attenuation and the microphone (near end) has priority.

T/R RATIO - transmit/receive ratio = 00: 1.2  
 = **01**: **1.5**  
 = 10: 2.0  
 = 11: 2.5

R/T RATIO - receive/transmit ratio = 00: 1.2  
 = **01**: **1.5**  
 = 10: 2.0  
 = 11: 2.5

If the T/R ratio is greater than the set value, then the microphone side is speaking. Conversely, if the R/T ratio is greater than the set value, then the line side is speaking.

#### Status (S1):

1110	R/T RATIO	T/R RATIO	LINE SENSITIVITY	MIC SENSITIVITY	PRIORITY	0
(15 - 12)	(11 - 10)	(9 - 8) (7 - 5)	(4 - 2)	(1)	(0)	

## D6571E Data Sheet

### Command (C2):

1110	MODE	PARAMETERS
(15 - 12)	(11 - 9)	(8 - 0)

MODE: = 0000: Get SpeakerPhone Status  
 = 0001: Get Line Monitor Status  
 = 001: Set SpeakerPhone Parameters  
 = 010: Set SpeakerPhone Configuration  
 = 011: Set SpeakerPhone Configuration 2  
 = 100: Tone Generation  
 = 101: Set SpeakerPhone Parameters 2  
 = 110: Reserved  
 = 111: Reserved

### MODE: = 0000: (Get SpeakerPhone Status)

#### Command:

1110	0000	00000000
(15-12)	(11-8)	(7 - 0)

#### Status:

1110		Direction	0	Loop Attenuation
(15-12)	(11-8)	(7-4)	(3)	(2-0)

Loop Attenuation: This indicates the amount of loop attenuation currently in use.

= 000	0 dB
= 001	-4 dB
= 010	-8 dB
= 011	-12 dB
= 100	-16 dB
= 101	-20 dB
= 110	-24 dB
= 111	-28 dB

Direction: This indicates which direction (microphone/speaker) is considered active by the DSP SpeakerPhone control logic. This is a 4 bit field used to represent the number range from +7 to -8. The most positive values indicate that the signal from the microphone side is dominant (microphone speaking). The most negative values indicate that the signal from the line side is dominant (telephone line speaking). Values in the center of the range can either indicate a transition from one side to the other, or if the value stays at approximately zero, indicates that neither side is talking.

= 0111	+7	
= 0110	+6	Microphone side is speaking.
= 0101	+5	
= 0100	+4	
= 0011	+3	

## D6571E Data Sheet

= 0010	+2	
= 0001	+1	
= 0000	0	Both sides silent (constant energy) or transition
= 1111	-1	
= 1110	-2	
= 1101	-3	
= 1100	-4	
= 1011	-5	
= 1010	-6	
= 1001	-7	Line side is speaking
= 1000	-8	

### MODE = 0001: (Get Line Monitor Status)

**Command:**

1110	0001	00000000
(15-12)	(11-8)	(7-0)

**Status:**

0111	0000	NEW	0	EXT TONE	TONE	DTMF
(15 - 12)	(11 - 8)	(7)	(6)	(5)	(4)	(3 - 0)

- NEW: 1: status has been updated by the D6571E, has not been read by Host  
 0: status does not contain information that has not been read by Host

The status will be updated by the D6571E each 1/2 of a frame (16.5 ms for 7.2 kHz sampling rate and 15 ms for 8 kHz sampling rate). The NEW bit will be set each time when the D6571E updates status. The New bit will be reset each time when Host reads Line Status.

### MODE = 001: (Set SpeakerPhone Parameters)

**Command:**

1110	001	LINE VOLUME	SPEAKER VOLUME	LOOP ATTENUATION
(15-12)	(11-9)	(8-7)	(6-3)	(2-0)

LINE VOLUME: Volume to the Line Out

= 00	+8 dB
= 01	+4 dB
= <b>10</b>	<b>0 dB</b>
= 11	MUTE

## D6571E Data Sheet

SPEAKER VOLUME: Volume to the Speaker Out

= 0000	+14 dB
= 0001	+12 dB
= 0010	+10 dB
= 0011	+8 dB
= 0100	+6 dB
= 0101	+4 dB
= 0110	+2 dB
= <b>0111</b>	<b>0 dB</b>
= 1000	-2 dB
= 1001	-4 dB
= 1010	-6 dB
= 1011	-8 dB
= 1100	-10 dB
= 1101	-12 dB
= 1110	-14 dB
= 1111	MUTE

LOOP ATTENUATION: Combined gain of receiver and transmitter attenuaters

= 000	0 dB	
= 001	-4 dB	Full-Duplex Operation
= 010	-8 dB	
= 011	-12 dB	
= 100	-16 dB	Natural Half-Duplex Operation
= 101	-20 dB	
= 110	-24 dB	
= 111	-28 dB	

*Status:*

1110	001	LINE VOLUME	SPEAKER VOLUME	LOOP ATTENUATION
(15-12)	(11-9)	(8-7)	(6-3)	(2-0)

**MODE = 010: (Set SpeakerPhone Configuration)**

*Command:*

1110	010	0	Twist	DT	Line Training Type	Automatic Loop Adjustment
(15-12)	(11-9)	(8)	(7-6)	(5-4)	(3-2)	(1-0)

Twist:	= <b>00:</b>	<b>-2 dB</b> (default value)
	= 01:	-4 dB
	= 10:	-6 dB
	= 11:	0 dB

Defines the twist of the DTMF tone generated in the SpeakerPhone mode. Twist defines the attenuation of the lower frequency of the dual frequency signal.

## D6571E Data Sheet

DT:                   = 00:     800 (6 dB less sensitive than default)  
                       = **01:**   **400** (default)  
                       = 10:     300 (3 dB more sensitive than default)  
                       = 11:     200 (6 dB more sensitive than default)

DT defines the threshold for the Dial Tone detector. Level below the threshold is considered noise and would not be detected.

LINE TRAINING TYPE: = 00:     Reserved  
                       = 01:     White noise injected into the line (250 msec duration)  
                       = 10:     Reserved  
                       = **11:**    **Voice adaptation** (default)

By default the DSP is in voice adaptation mode. White noise can be injected to the line, after the noise pulse the DSP automatically returns to voice adaptation mode.

Automatic LOOP Adjustment: = 00:     Reserved  
                               = 01:     Reserved  
                               = **10:**    **Automatic loop adjustment** (default)  
                               = 11:     Reserved

The automatic loop adjustment mode is the default and is the only mode available.

### Status:

1110	010	0	Twist	DT	Line Training Type	Automatic Loop Adjustment
(15-12)	(11-9)	(8)	(7-6)	(5-4)	(3-2)	(1-0)

## MODE = 011: (Set SpeakerPhone Configuration 2)

### Command:

1110	011	0	Speaker Noise	Line Noise	Line Process	Mic VOX position	Mic VOX Response	Line VOX Response
(15-12)	(11-9)	(8)	(7)	(6)	(5)	(4)	(3-2)	(1-0)

Speaker Noise:     = **0:** **Off** (default)  
                       = 1: **On**

When the Speaker Noise bit is set, a white noise pulse of duration 250 msec is injected into the speaker. After the pulse the DSP automatically returns to the adaptation mode of the AEC.

Line Noise:        = **0:** **Off** (default)  
                       = 1: **On**

When the Line Noise bit is set, a white noise pulse of duration 250 msec is injected into the line. (This is equivalent to Line Training Type 1 in the SpeakerPhone Configuration Command). After the pulse the DSP automatically returns to the adaptation mode of the LEC.

Line Processing:   = **0:** **Off** (default)  
                       = 1: **On**



## D6571E Data Sheet

This option allows additional linear processing to reduce the far end residual echo by 6 dB.

Mic VOX Position: = **0**: Mic VOX detector is before the volume compensater (compatible with the D6385A, D6386A, D6455A)  
 = **1**: Mic VOX detector is after the volume compensater

Line VOX Response: = **00**: **High Pass Filter** (default)  
 = **01**: Flat  
 = **10**: Reserved  
 = **11**: Reserved

Mic VOX Response: = **00**: **High Pass Filter** (default)  
 = **01**: Flat  
 = **Else**: Reserved

### Status:

1110	011	0	Speaker Noise	Line Noise	Line Process	Mic VOX position	Mic VOX Response	Line VOX Response
(15-12)	(11-9)	(8)	(7)	(6)	(5)	(4)	(3-2)	(1-0)

## MODE = 100: (Tone Generation)

### Command:

1110	100	TONE GAIN			TONE INDEX			
(15-12)	(11-9)	(8-5)			(4-0)			

See the TONE GENERATION command for usage and TONE GAIN and TONE INDEX definitions.

Each command/status interaction generates a tone 1 frame long (33 ms for 7.2 kHz sampling rate and 30 ms for 8 kHz sampling rate).

Tone Index: 0 - 16 (only 16 standard DTMF tones are available in the SpeakerPhone mode)

Only the tones from the “standard” tone table are available in SpeakerPhone mode. No tones, defined by New Tone Definition command, are available in SpeakerPhone mode. Gain of these tones is defined by the TONE GAIN parameter. Twist is defined by Twist Parameter (SpeakerPhone Configuration command).

### Status:

1110	100	TONE GAIN			TONE INDEX			
(15-12)	(11-9)	(8-5)			(4-0)			

## MODE = 101: (Set SpeakerPhone Parameters 2)

The Set SpeakerPhone Parameters 2 Command (Mode 101) allows additional control over the range for the Loop Attenuation, Speaker Volume, Line Volume, and T/R and R/T ratios. If extended range is not a requirement, the Set SpeakerPhone Parameters Command (Mode 001) can be used rather than this command. This command also introduces the Acoustical Decoupling and Electrical Decoupling parameters.

## D6571E Data Sheet

### Command:

1110	101	Parameter	Value
(15-12)	(11-9)	(8-6)	(5-0)

Parameter: = 000: Loop Attenuation  
 = 001: Speaker Volume  
 = 010: Acoustic Decoupling  
 = 011: Line Volume  
 = 100: Electrical Decoupling  
 = 101: T/R and R/T ratios  
 = 110: Reserved  
 = 111: Reserved

Value: = Value of the parameter to be set

For Speaker Volume and Line Volume (Parameter = 001 or 011):

<u>Value</u>	<u>Volume</u>
= 000000	+20 dB
= 000001	+18 dB
= 000010	+16 dB
= 000011	+14 dB
= 000100	+12 dB
= 000101	+10 dB
= 000110	+8 dB
= 000111	+6 dB
= 001000	+4 dB
= 001001	+2 dB
= <b>001010</b>	<b>0 dB</b>
= 001011	-2 dB
= 001100	-4 dB
= 001101	-6 dB
= 001110	-8 dB
= 001111	-10 dB
= 010000	-12 dB
= 010001	-14 dB
= 010010	-16 dB
= 010011	-18 dB
= 010100	-20 dB
= 010101	MUTE

For Loop Attenuation (Parameter = 000):

<u>Value</u>	<u>Attenuation</u>
= 000000	0 dB
= 000001	4 dB
= <b>000010</b>	<b>8 dB</b>
= 000011	12 dB
= 000100	16 dB
= 000101	20 dB
= 000110	24 dB

## D6571E Data Sheet

= 000111      28 dB

For Acoustical and Electrical Decoupling (Parameter = 010 and 100):

<u>Value</u>	<u>Volume</u>
= <b>000000</b>	<b>0 dB</b>
= 000001	-2 dB
= 000010	-4 dB
= 000011	-6 dB
= 000100	-8 dB
= 000101	-10 dB
= 000110	-12 dB
= 000111	-14 dB
= 001000	-16 dB
= 001001	-18 dB
= 001010	-20 dB

For R/T and T/R ratios (Parameter = 101):

Bits 0,1,2 are for T/R ratio

Bits 3,4,5 are for R/T ratio

<u>Value</u>	<u>Ratio</u>
= 000	1.2
= 001	1.5
= 010	2.0
= 011	2.5
= 100	3.0
= 101	3.5
= 110	4.0
= 111	Reserved

### Status:

1110	101	Parameter	Value
(15 - 12)	(11 - 9)	(8 - 6)	(5 - 0)

## D6571E Data Sheet

### 16. Re-Compress Message

#### Command (C1):

1 1 1 1	1 1 1	0 0	Message Number
(15 - 12)	(11 - 9)	(8 - 7)	(6 - 0)

#### Status (S1):

1 1 1 1	1 1 1	0 0	Message Number
(15 - 12)	(11 - 9)	(8 - 7)	(6 - 0)

#### Command (C2):

1 1 1 1	0 0	New Compression	0 0	GAP	0 0 0 0
(15 - 12)	(11 - 10)	(9 - 7)	(6 - 5)	(4)	(3 - 0)

New Compression Rate: = 000: Re-compress message to the low bit rate  
 = 001: Re-compress message to the middle bit rate  
 = 010: Re-compress message with high bit rate  
 = Else: Reserved

GAP = 0: Re-compress message without "gap coding" activated  
 = 1: Re-compress message with "gap coding"

#### Status (S2):

1 1 1 1	0 0	New Compression	0 0	GAP	0 0 0 0
(15 - 12)	(11 - 10)	(9 - 7)	(6 - 5)	(4)	(3 - 0)

MEM FULL = 1: There is no memory available to re-compress message

ERROR = 1: Error is detected.  
 Errors: - message does not exist  
 - PCM message  
 - Binary message

#### Command (C3):

1 1 1 1	0 0	0	0 0	0	0 0 0 0
(15 - 12)	(11 - 10)	(9 - 7)	(6 - 5)	(4)	(3 - 0)

#### Status (S3):

1 1 1 1	READY	ERROR	0 0	MEM FULL	0 0	0	0 0 0 0
(15 - 12)	(11)	(10)	(9 - 8)	(7)	(6 - 5)	(4)	(3 - 0)

## D6571E Data Sheet

Recompression starts with the C1 command (starts the mode and define message number) followed by the C2 command which defines new bit rate that the message will be recompressed to. Actual decompression starts after C2 command. Host keeps sending monitoring command during decompression. When re-compression is complete the D6571E returns status with bit READY set to "1." If Memory Full condition is reached the D6571E will send status with bit MEM FULL set and will terminate re-compression. If Idle command is detected instead of monitoring command the re-compression will be terminated.

**Garbage Collection should be run prior to and after Re-Compression mode. Read Memory Status command should be sent by Host. Then Garbage Collection should be run if recommended. The same should be performed after re-compression of each message.**

# D6571E Data Sheet

## FUNCTIONAL BLOCKS

The block diagram in Figure 5 shows the D6571E functional blocks and interface functional blocks and interface.

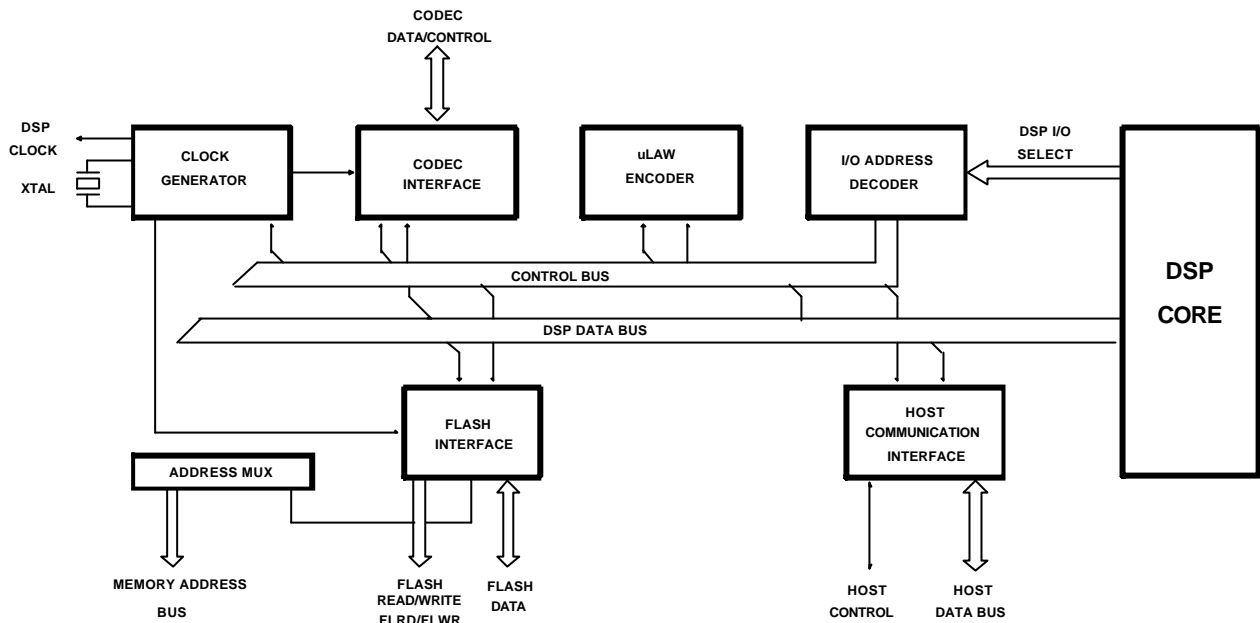

Figure 5. D6571E-11 Block Diagram

D0091A

### DSP CORE

At the heart of the chipset is the DSP core. All of the software algorithms such as compression, decompression, tone detection, tone generation, and echo cancellation run on that processor. The DSP core controls the system, memory and message management. The DSP program ROM is masked internally. The DSP is connected via an internal bus to most of the other modules within the D6571E-11 chip.

### ADDRESS MUX

Address MUX controls external memory select signals and memory address bus.

### FLASH MEMORY INTERFACE

The Flash memory interface provides access to the Flash memory message storage. The interface supports up to 4 Flash devices with 4 Mbit configuration and 1 device with 16 Mbit configuration.

### CLOCK GENERATOR

This block provides clock signals to the DSP core and all the internal devices. It also includes clock rate reduction in Power Down mode.

### m-law/A-law ENCODER

This interface provides converting linear code (14-bit) to 8-bit  $\mu$ -law or A-law PCM code.

### CODEC INTERFACE

The CODEC Interface implements the data transfer and synchronization functions required interfacing the DSP with the CODEC chip. The data transfer to/from the CODECs is serial. The CODEC interface supports fixed and variable rate CODECs.

### I/O ADDRESS DECODER

The I/O Address Decoder generates the required I/O read and write pulses for the internal DSP peripheral devices.

# D6571E Data Sheet

## HOST D6571E COMMUNICATION INTERFACE

The HOST communication port is a 16-bit bi-directional register. The D6571E will access this register internally by one 16-bit wide access. The HOST assesses this register via the 8-bit bus in two accesses: first low byte then high byte. After the HOST writes a command to the High byte of this register the D6571E accepts this command.

When the D6571E writes a status word to the communication register it sets the ACK pin low which is connected to the HOST for indication. The HOST can use this pin as an interrupt or poll this signal periodically. When the HOST reads the high byte of this register the DSP sets the ACK bit high. The choice of high/low byte for the HOST will be made by the HI/LO pin. The HOST should read the low byte of the status word first, then the high byte.

The D6571E will send a status word only in response to a Host command except for the initial Garbage Collection Status word.

Table 1. Host Interface Signals

Pin Name	Type (*)	Description
HSTDB[0..7]	Input/Output	HOST 8-bit data bus
HSTRD	Input	HOST READ line from register
HSTWR	Input	HOST WRITE line into register
ACK	Output	Flag to HOST status byte ready
HI/LO	Input	High or Low byte select
CS	Input	When High, disables Host interface **

\* Input and Output are referenced to the D6571E-11.

\*\* Connection to ground recommended when not used.

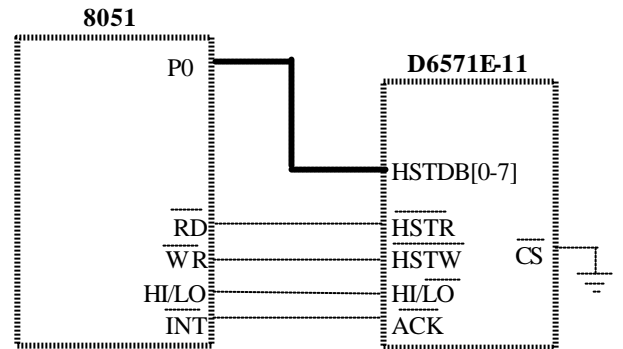
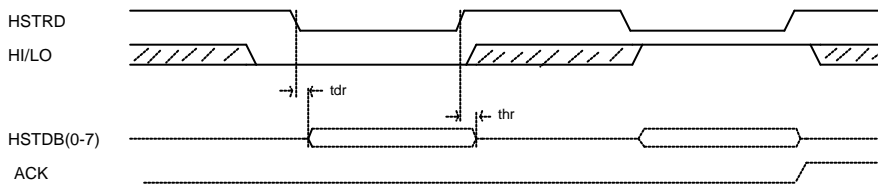

Figure 6. Host Interface D6571E - 8051

## HOST READ CYCLE



## HOST WRITE CYCLE

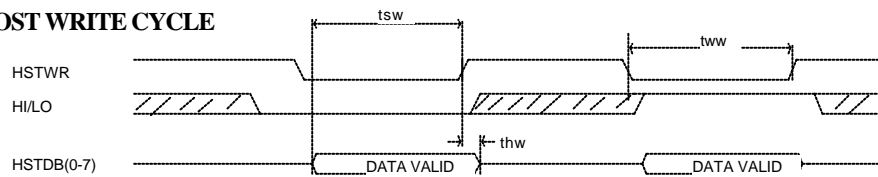

Figure 7. D6571E - Host Interface Timing Data

thr = 2 ns minimum
tdr = 25 ns maximum
thw = 5 ns minimum
tsw = 30 ns minimum
tww = 55 ns minimum

# D6571E Data Sheet

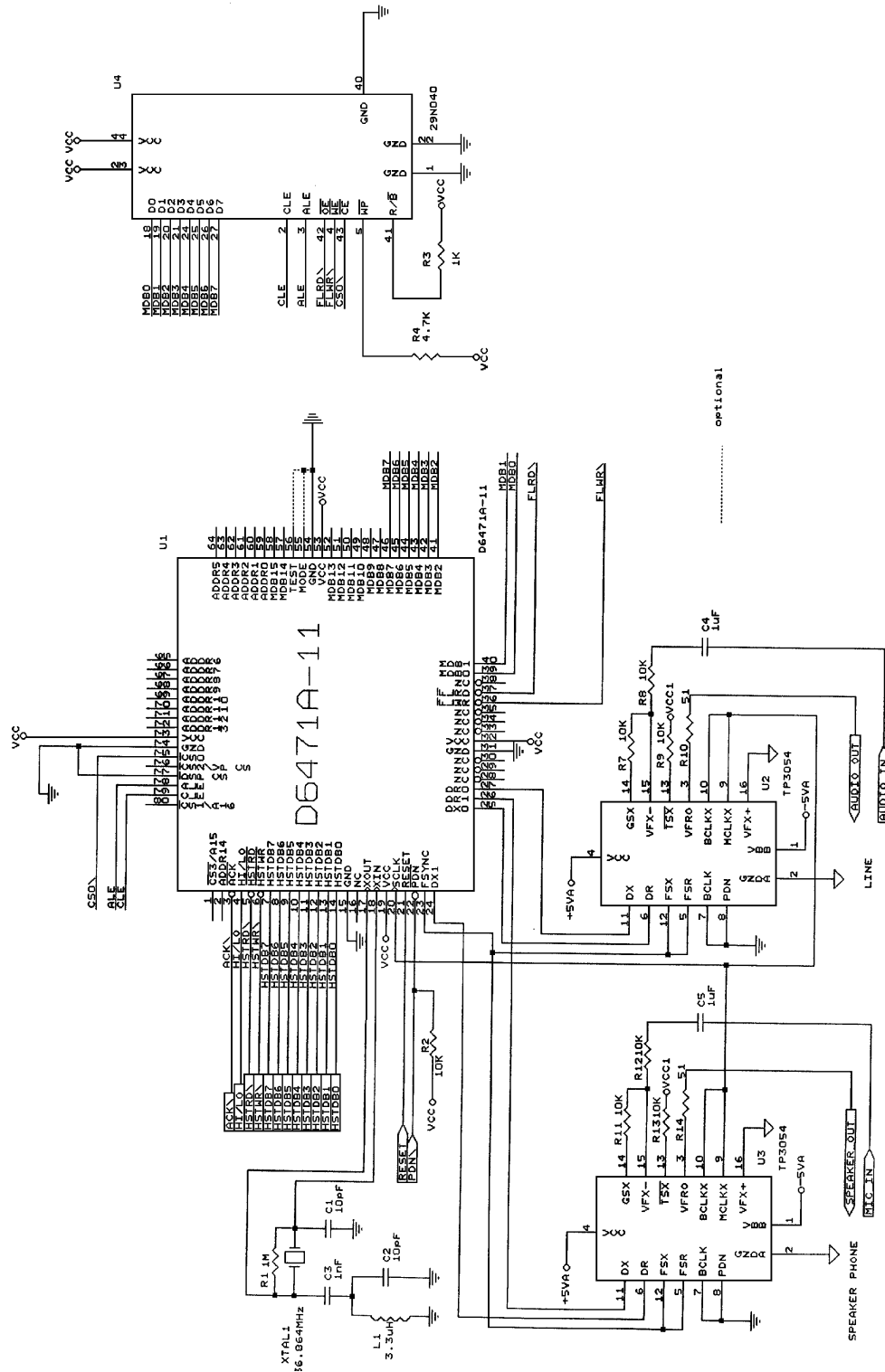

Figure 8. Chipset Interconnection with One Samsung 4 Mbit Flash Memory Device and 36.864 MHz crystal



# D6571E Data Sheet

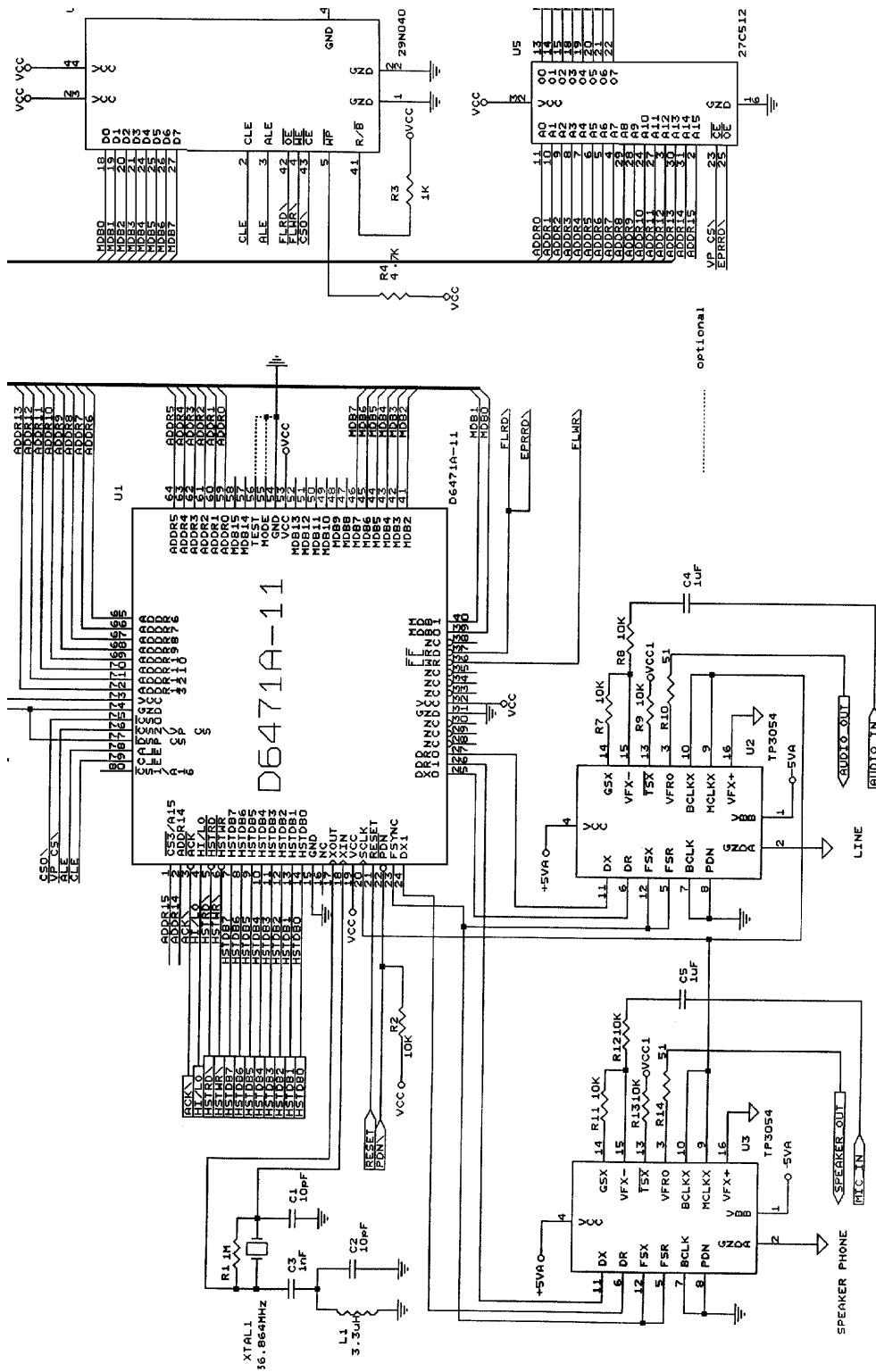

Figure 9. Chipset Interconnection with One Samsung 4 Mbit Flash Memory Device, One 64Kx 8 Voice Prompt EPROM, and 40.960 MHz crystal

## D6571E Data Sheet

### DATA TRANSFER MODES

#### FUNCTIONAL DESCRIPTION

For most TAD applications, the D6571E receives speech data from the CODEC, compresses it with the TRUESPEECH compression algorithm and stores (“records”) it into the Flash. To playback previously compressed speech, the D6571E retrieves data from the Flash, decompresses it, and plays it back via CODEC. However, for some applications it is necessary to transmit/receive voice data to/from the Host. This allows, for example, the ability to store compressed speech data in another storage media or transfer it to another location. To enable these functions, the following speech files transferring modes via Host Data Bus are implemented in the D6571E.

**Voice Data Pump from CODEC to Host.** The D6571E receives data from the CODEC and transmits via the Host Data Bus in real time. Two submodes are available. In one of them, the D6571E performs TRUESPEECH speech compression and then transmits it to the Host. All three compression rates and “gap coding” compression techniques are available. In the other submode, the D6571E transmits data without compression in  $\mu$ -law or A-law PCM format.

This mode is fully functional in case of “cold start.”

**Voice Data Pump from Host to CODEC.** The D6571E receives speech data via Host Data Bus and plays it back via the CODEC in real time. Two submodes are available. In one of them the D6571E receives data previously compressed with TRUESPEECH coder, performs decompression, and then plays it back via the CODEC. In the other submode the D6571E receives the data from the Host in  $\mu$ -law or A-law PCM format and plays it via the CODEC without decompression.

This mode is fully functional in case of “cold start.”

**Data Storage (from Host to Flash).** The D6571E retrieves data via the Host Data Bus and stores it into the Flash. The D6571E is capable of storing binary (non speech) messages.

**Data Retrieval (from Flash to Host).** The D6571E retrieves data from the Flash and transmits it via the Host Data Bus.

**Voice Data Compression.** The D6571E receives linear PCM data via the Host Data Bus, compresses it with the TRUESPEECH compression algorithm, and transmits it back to the Host via the Host Data Bus. All three compression rates and “gap coding” compression techniques are available.

This mode is fully functional in case of “cold start”

**Voice Data Decompression.** The D6571E receives speech data previously compressed with the TRUESPEECH compression algorithm via the Host Data Bus. The D6571E decompresses the data, and transmits it back to the Host via the Host Data Bus in linear PCM format.

This mode is fully functional in case of “cold start.”

**Important Note About Data Transfer.** Two formats will be used by the D6571E to transfer data (Byte Transfer and Word Transfer). For *uncompressed* speech data, Word Transfer will be used and the Host or D6571E will use bits 15-0 of the Host Data Bus to send a *word of data*. For *compressed* TRUESPEECH data, Byte Transfer will be used and the Host or D6571E will use the high byte (bits 15-8) of the Host Data Bus to send a *byte of data*.

When Byte Transfer is utilized, the HI/LO pin (pin 4) of the D6571E should be set to high during the command/status sequence. In this manner, the high byte of the Host Data Bus (bits 15-8) will be used to transfer a byte of data. With the HI/LO pin set to high the Host can still send a word to the D6571E, but the low byte will be ignored by the D6571E during Byte Transfer.

#### OPERATIONAL DESCRIPTION

##### TRUESPEECH Data Pump from CODEC to Host

In this mode, the D6571E receives speech data from the CODEC, performs the compression with the TRUESPEECH algorithm, and transmits the compressed data via the Host Data Bus in bursts of words for each frame. The size of bursts depends on the compression rate can be between 0 to 48 bytes per cycle.

The TRUESPEECH compression algorithm implemented in the D6571E is Host programmable and is able to utilize three rates as well as “gap coding”. The first Data Pump command C1 defines compression rate (see command set for details).

## D6571E Data Sheet

In the first Data Pump command C1, the Host can activate or disable audio loop back in the Data Pump mode.

To start processing each frame the Host issues command C2. The D6571E returns status S2 of this command to Host. Normally status S2 will contain telephone line status (VOX, Tone, and DTMF detection).

Upon receiving status S2 the Host issues command C3. Command C3 contains the number of bytes that the Host expects to receive from the D6571E in this particular frame. In status S3, the D6571E returns the actual number of bytes that the D6571E is going to transmit to the Host in this frame.

The actual number of bytes to be transmitted depends on the compression rate and may vary from frame to frame.

After the Host reads the status S3, the actual data transfer begins. The Host sends to the D6571E Data Transfer commands (the number of commands depends on the number 'Transfer Number of Bytes') and gets a byte of data for each Data Transfer command that is sent.

The Host sends the high byte (bits 15-8) of a Data Transfer Command. In response to a command the D6571E uses the high byte (bits 15-8) of the status word to send a byte of data to the Host (Data Transfer status).

With Byte Transfer, the HI/LO pin (pin 4) of the D6571E should be set to high during the command/status sequence. In this manner, the high byte of the Host Data Bus will be used to transfer a byte of data. The Host can still send a word to the D6571E, but the low byte will be ignored by the D6571E during Byte Transfer.

After sending the last byte of data to the Host, the D6571E is ready to process another frame. The Host then sends the next C2 command to start processing the next frame. In this manner, the D6571E compresses and transmits data frame by frame in real time.

While in Data Pump mode, the D6571E monitors the telephone line and reports this data to the Host in S2. Command C2 can instruct the D6571E to generate a tone while in Data Pump mode. Status S2 will contain telephone line status in this case as well.

Data Pump mode can be terminated by command C2 with a non-zero Stop parameter. This mode can be terminated by issuing an Idle command instead of command C2. In addition, at each command (C1, C2, C3) the D6571E checks bits 15-12 for the correct code. If an incorrect code is detected, the D6571E will return to Idle mode.

Instead of sending the Data Pump C2 command, the Host can send a Set Volume Level command to set the volume level. The D6571E will respond with Data Pump Status S2 as if 'continue record' command was sent. For the appropriate volume level settings, refer to the description of the Set Volume Level command in the Self-Test and Initialization mode (Test Mode = 1000).

It is the Host's responsibility to perform communication quickly enough to avoid a real time problem. The length of time it takes to process one frame, including data transfer to the Host, should be no longer than 1 frame (30 ms for 8 KHz sampling rate and 33 ms for 7.2 KHz sampling rate).

The performance of the mode is the same in case of "cold start."

### PCM Data Pump from CODEC to Host

In this mode, the D6571E receives  $\mu$ -law or A-law PCM data from the CODEC and transmits this data via Host Data Bus in bursts of 120 words per frame in real time.

The first Data Pump command C1 defines the mode and activates or disables audio loop back. To process each frame the Host issues command C2 and then reads status S2 of this command. Normally, status S2 will contain line status (VOX, Tone, and DTMF detection).

Upon receiving status S2, the Host sends command C3 with the number of words the Host expects to receive from the D6571E. The D6571E returns status S3 with the actual number of words to be transferred from D6571E to Host. In this mode, the number of words is 120. The actual data transfer begins upon receiving status S3. The Host issues 120 data transfer commands and receives 120 words of speech data.

The Host uses the high byte (bits 15-8) to send a Data Transfer command to the D6571E. The Host can still send a word to the D6571E, but the low byte will be ignored by the D6571E. In response to each command, the D6571E will return the Data Transfer status, which contains a word of data. After transmitting a burst of

## D6571E Data Sheet

words the Host issues command C2 to start processing the next frame.

While in Data Pump mode, the D6571E monitors the telephone line and reports this data to the Host in S2.

Data Pump mode can be terminated by command C2 with a non-zero Stop parameter. This mode can be terminated by issuing an Idle command instead of command C2. In addition, at each command (C1, C2, C3) the D6571E checks bits 15-12 for the correct code. If an incorrect code is detected, the D6571E will return to Idle mode.

Instead of sending the Data Pump C2 command, the Host can send a Set Volume Level command to set the volume level. The D6571E will respond with Data Pump Status S2 as if 'continue record' command was sent. For the appropriate volume level settings, refer to the description of the Set Volume Level command in the Self-Test and Initialization mode (Test Mode = 1000).

It is the Host's responsibility to perform communication quickly enough to avoid a real time problem. The length of time it takes to process one frame, including data transfer to the Host, should be no longer than 1 frame.

The performance of the mode is the same in case of "cold start."

### TRUESPEECH Data Pump from Host to CODEC

In this mode the D6571E receives compressed speech in bursts of data via the Host Data Bus, decompresses it, and plays it back via the CODEC.

Upon receiving the first Data Pump command C1 the D6571E enters the mode and returns status S1 to the Host. This command should only be issued once for this mode. Upon receiving status S1 the Host issues command C2 to start processing a frame. The D6571E responds by returning to the Host, status S2 with telephone line status information (DTMF and Tone Detection).

Then, the Host issues command C3 with the number of bytes that the Host is planning to transmit in the current frame. The D6571E returns status S3 with the actual number of bytes the D6571E will accept from the Host in this frame. The number of bytes to be transferred in each frame depends upon the compression rate and may vary from frame to frame.

Upon receiving S3, the actual data transfer begins. The number of Data Transfer commands is determined by the information in bits 0-7 of status S3. Upon receiving each of these commands, the D6571E returns to the Host an echo of this command in the Data Transfer status.

The Host uses the high byte (bits 15-8) send a byte of data to the D6571E (Data Transfer Command). In response to a command the D6571E uses the high byte (bits 15-8) to echo the byte of data that was received (Data Transfer status). After the last Data Transfer status is sent the Host can send another C2 command to start the processing cycle again.

With Byte Transfer, the HI/LO pin (pin 4) of the D6571E should be set to high during the command/status sequence. In doing so, the high byte of the command/status will be used to transfer a byte of data. The Host can still send a word to the D6571E, but the low byte will be ignored by the D6571E during Byte Transfer.

In this manner, the D6571E decompresses and transmits data frame by frame in real time. If the Host is going to transmit less data than is necessary for the D6571E to decompress the next frame, the D6571E will report this in bit IND (insufficient data) of S3.

While in Data Pump mode, the D6571E monitors the telephone line and reports this data to the Host in S2. Command C2 can instruct the D6571E to generate a tone while in Data Pump mode. Status S2 will contain telephone line status in this case as well.

This mode can be terminated by issuing an Idle command instead of command C2. In addition, at each command (C1, C2, C3) the D6571E checks bits 15-12 for the correct code. If an incorrect code is detected, the D6571E will return to Idle mode.

Instead of sending the Data Pump C2 command, the Host can send a Set Volume Level command to set the volume level. The D6571E will respond with Data Pump Status S2 as if 'continue record' command was sent. For the appropriate volume level settings, refer to the description of the Set Volume Level command in the Self-Test and Initialization mode (Test Mode = 1000).

It is the Host's responsibility to perform communication quickly enough to avoid a real time problem. The length of time it takes to process one frame, including data transfer to the Host, should be no longer than 1 frame.

## D6571E Data Sheet

The performance of the mode is the same in case of “cold start.”

### PCM Data Pump from Host to CODEC

In this mode, the D6571E receives  $\mu$ -law or A-law PCM data via the Host in bursts of 120 words and plays it back via the CODEC. This mode is similar to the previous one. The major difference is that the data bursts have a fixed size of 120 words per frame.

While in this mode the D6571E monitors the status of the telephone line and reports this information to the Host in status S2. This mode can be terminated by issuing an Idle command instead of command C2. In addition, at each command (C1, C2, C3) the D6571E checks bits 15-12 for the correct code. If an incorrect code is detected, the D6571E will return to Idle mode.

As with the previous mode, the Host can send a Set Volume Level command instead of a Data Pump C2 command to set the volume level. The D6571E will respond with Data Pump Status S2 as if ‘continue record’ command was sent.

It is the Host’s responsibility to perform communication quickly enough to avoid a real time problem. The length of time it takes to process one frame, including data transfer to the Host, should be no longer than 1 frame.

The performance of the mode is the same in case of “cold start.”

### Data Storage

In this mode, the D6571E receives data via Host Data Bus and stores it in the Flash as a binary message. The D6571E assigns the next available message number to this message.

Upon receiving the first Data Storage command C1 the D6571E enters the mode and sends status with Memory Full bit to Host. The C1 command contains BIN bit. = 1.

Then the Host sends C2 command with the number of words that the Host is going to transmit to the D6571E. The D6571E responds with status S2 with the number of words that the D6571E will accept from the Host in this particular frame. Upon receiving S2, the actual data transfer begins. The Host sends the appropriate

number of Data Transfer commands. Each of these commands contains data.

The Host issues the next C1 command to start processing the next frame.

In this manner, the data can be transferred via Host Data Bus and stored in the Flash. After receiving each C1 command, the D6571E checks the Memory Full Status Bit and reports it to the Host in S1.

This mode can be terminated by issuing an Idle command instead of command C1. In addition, at each command (C1, C2) the D6571E checks bits 15-12 for the correct code. If an incorrect code is detected, the D6571E will return to Idle mode.

### Data Retrieval

In this mode, the D6571E retrieves a message from the Flash and transmits it via the Host Data Bus in bursts of bytes.

Upon receiving the first Data Retrieval command C1, which specifies the message number to be retrieved, the D6571E enters the mode and sends status S1 with End of Message Bit and BIN bit =1. Upon receiving status S1 the Host sends command C2 with the number of bytes the Host expects from the D6571E. The D6571E returns status S2 with the actual number of words the D6571E will send to the Host in this particular frame.

Upon receiving S2 the actual transfer begins. The Host sends the appropriate number of Data Transfer commands.

Upon transmitting bursts of words the D6571E can process the next frame. The Host issues the next C1 command to start transmission of the next frame.

In this manner, the data can be retrieved from the Flash and transmitted via Host data Bus. After receiving each C1 command the D6571E checks the status of the message that is retrieved and reports end of message to the Host in S1.

This mode can be terminated by issuing an Idle command instead of command C1. In addition, at each command (C1, C2) the D6571E checks bits 15-12 for the correct code. If an incorrect code is detected, the D6571E will return to Idle mode.

### Data Compression Mode

## D6571E Data Sheet

In this mode, the D6571E receives linear PCM data via Host Data Bus in burst of 240 words, compresses it with TRUESPEECH compression algorithm, and transmits it back via Host Data Bus in bursts of bytes. The size of bursts depends on the compression rate.

The TRUESPEECH compression algorithm implemented in the D6571E is Host programmable and is able to utilize three compression rates as well as “gap coding”. The first Voice Data Compression command C1 defines the compression rate.

Then the Host issues command C2. This command contains the number of words the Host is going to transmit to the D6571E. The D6571E returns status S2, which contains the number of words the D6571E will accept from the Host. Upon receiving S2 the actual Word Transfer begins. The Host sends 240 words of uncompressed speech data. The D6571E responds with an echo of each word.

Upon receiving uncompressed speech the D6571E starts compression of the current frame. The Host issues the C3 command, which will be accepted by the D6571E after compression of the current frame is accepted. The C3 command contains the number of bytes which the Host expects to receive from the D6571E (48 bytes). In the status S3, the D6571E informs the Host the actual number of bytes the D6571E will transmit.

After Host reads the status S3, the actual Byte Transfer begins. The Host uses the high byte (bits 15-8) of the Data Transfer Command. In response to a command the D6571E sends the byte of compressed data in the high byte (bits 15-8) of the Data Transfer status.

With Byte Transfer, the HI/LO pin (pin 4) of the D6571E should be set to high during the command/status sequence. The Host can still send a word to the D6571E, but the low byte will be ignored by the D6571E during Byte Transfer.

The Host sends the Next C1 command to start processing the next frame. In this manner, the D6571E compresses and transmits data frame by frame. This mode can be terminated by issuing an Idle command instead of command C2. In addition, at each command (C1, C2 and C3) the D6571E checks bits 15-12 for the correct code. If an incorrect code is detected, the D6571E will return to Idle mode.

The performance of the mode is the same in case of “cold start.”

### Data Decompression Mode

In this mode, the D6571E receives speech data previously compressed with TRUESPEECH via the Host Data Bus, compresses it, and transmits it back in linear format in bursts of words.

The D6571E receives the first Data Decompression command C1 and returns status S1. Then the Host sends command C2 with the number of bytes that the Host is going to transmit to the D6571E (48 bytes). The D6571E returns status S2 with the actual number of bytes that the D6571E will accept from the Host in the current frame. After the Host receives S2, the actual Byte Transfer begins. The Host sends the appropriate number of Data Transfer commands, which contain compressed speech and receives an echo of each command in the Data Transfer status.

The Host sends the byte of data in high byte of the Data Transfer Command. In response to each command the D6571E sends back the echo of the byte in the high byte of the Data Transfer status.

With Byte Transfer, the HI/LO pin (pin 4) of the D6571E should be set to high during the command/status sequence.

After the D6571E accepts the bursts of bytes, it starts decompression. To receive the decompressed data, the Host sends a C3 command. The C3 command will be accepted by the D6571E after decompression of the current frame is completed. Command C3 contains the number of words the Host expects to receive from the D6571E (240 words). In status S3, the D6571E sends the actual number of words the D6571E is going to transmit to the Host. After the Host receives S3, the Word Transfer begins. Then the Host sends the appropriate number of Data Transfer commands and receives a word of linear PCM data in response to each command (Data Transfer status).

The Host sends the next C1 command to start processing the next frame. In this manner, the D6571E decompresses and transmits data frame by frame. This mode can be terminated by issuing an Idle command instead of command C2. In addition, at each command (C1, C2 and C3) the D6571E checks bits 15-12 for the correct code. If an incorrect code is detected, the D6571E will return to Idle mode.

## **D6571E Data Sheet**

The performance of the mode is the same in case of  
“cold start.”

**D6571E Data Sheet**

**COMMAND SET FOR DATA TRANSFER MODES**

**1. DATA PUMP FROM CODEC TO HOST (Record from Codec to Host)**

**Command (C1):**

0001	1 1	COMP MODE	LB DIS	GAP	0 0 0 0
(15-12)	(11-10)	(9-6)	(5)	(4)	(3 - 0)

COMP MODE:     = 0000: Low bit rate  
                   = 0010: Middle bit rate  
                   = 0100: High bit rate  
                   = 0011:  $\mu$ -law or A-law PCM (no compression)  
                   = Else: Reserved

LB DIS           = 1: Disable loopback of input samples  
                   = 0: Enable loopback of input samples

GAP             = 0: Gap Coding is disabled  
                   = 1: Activate Gap Coding

**Status (S1):**

0001	1 1	COMP MODE	LB DIS	GAP	0 0 0 0
(15-12)	(11-10)	(9-6)	(5)	(4)	(3 - 0)

**Command (C2):**

0 0 0 1	0 0	T	STOP/TONE PARAMETERS
(15-12)	(11 - 10)	(9)	(8 - 0)

T               = 1: To initiate tone generation (not valid for Mode = 100).  
                   = 0: For no tone generation.

When T=0:

(C2):

STOP
(8 - 0)

STOP = 00000000: Continue record and monitor status  
 STOP = 00000001: End record.

When T=1:

(C2):

TONE GAIN	TONE INDEX
(8 - 5)	(4 - 0)



## D6571E Data Sheet

### Status (S2):

0001	00	T	00	STATUS
(15-12)	(11-10)	(9)	(8-7)	(6-0)

When T = 1 or T = 0 and STOP = 00000000:

(S2):

VOX	EXT TONE	TONE	DTMF
(6)	(5)	(4)	(3-0)

VOX =1: Speech frame was detected.

TONE =1: Call progress tone was detected in last frame.

DTMF } = Code of valid DTMF or CAS signal detected.

EXT TONE }

When T = 0 and STOP = 00000001:

(S2):

000001
(6-0)

### Command (C3):

0001	0000	NUMBER OF BYTES (for compressed data) NUMBER OF WORDS (for $\mu$ /A-law PCM data)
(15-12)	(11-8)	(7-0)

NUMBER OF BYTES - Indicates the number of bytes the Host expects to receive from the D6571E in the current frame. This number should generally be set to the maximum number of bytes per frame (48).

NUMBER OF WORDS - Indicates the number of words the Host expects to receive from the D6571E in the current frame. This number should generally be set to the maximum number of words per frame (120).

### Status (S3):

0001	0000	TRANSFER NUMBER OF BYTES (for compressed data) TRANSFER NUMBER OF WORDS (for $\mu$ /A-law PCM data)
(15-12)	(11-8)	(7-0)

TRANSFER NUMBER OF BYTES - Indicates the actual number of bytes which the D6571E will transfer to the Host. This number can be between 2 and 48.

TRANSFER NUMBER OF WORDS - Indicates the actual number of words that the D6571E will transfer to the Host. This number is 120.

After the Host receives status S3, the actual data transfer begins. Shown below are the descriptions for TrueSpeech Data Pump and  $\mu$ -law/A-law PCM Data Pump.

## D6571E Data Sheet

### TrueSpeech Data Pump:

For compressed data, the Host sends the high byte of the command word (Data Transfer command) to the D6571E. The D6571E responds with compressed data in the high byte of the status (Data Transfer status). During the data transfer phase, the HI\LO pin (pin 4) should be set to high.

#### Data Transfer Command:

(DC1 . . . DC\_Transfer\_Number\_of\_Bytes for TrueSpeech Data Pump)

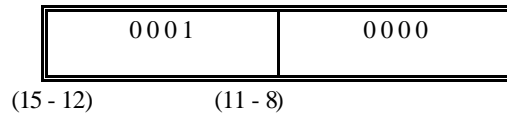

#### Data Transfer Status:

(DS1 . . . DS\_Transfer\_Number\_of\_Bytes for TrueSpeech Data Pump)



### $\mu$ -law/A-law PCM Data Pump:

For  $\mu$ -law/A-law PCM data, the Host sends the high byte of the command word (Data Transfer command) to the D6571E. The D6571E responds with a word of the  $\mu$ -law/A-law data in the status word (Data Transfer status).

#### Data Transfer Command:

(DC1 . . . DC\_120 for  $\mu$ -law/A-law PCM Data Pump)

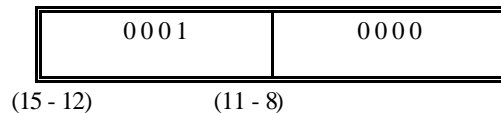

#### Data Transfer Status:

(DS1 . . . DS\_120 for  $\mu$ -law/A-law PCM Data Pump)



For both TrueSpeech and  $\mu$ -law/A-law Data Pumps, in each frame the Host issues command C2, reads status S2, then issues command C3. Status S3 will be sent to the Host after the D6571E completes compression of the current frame. The actual data transfer starts after S3 is received by the Host. After data transfer is completed the Host should issue the next C2 command. The D6571E checks bits 15 -12 in the C1, C2, and C3 commands for the correct code. If an incorrect code is detected, the D6571E will return to Idle mode.

**NOTE:** Instead of sending the Data Pump C2 command as shown above, the Host can send a Set Volume Level command to set the volume level. The D6571E will respond with Data Pump Status S2 as if 'continue record' command was executed. The 'Set Volume C2 Command' and status S2 are shown below.

## D6571E Data Sheet

### Command (C2): Set Volume

1100	1000	100	VOLUME
(15 - 12)	(11 - 8)	(7 - 5)	(4 - 0)

For the appropriate VOLUME level settings, please refer to the Set Volume Level command in the Self-Test and Initialization mode (Test Mode = 1000).

### Status (S2): Set Volume

1100	00000	VOX	EXT TONE	TONE	DTMF
(15 - 12)	(11 - 7)	(6)	(5)	(4)	(3-0)

VOX =1: Speech frame was detected.  
 =1: Call progress tone was detected in last frame.  
 DTMF } : Code of valid DTMF or CAS signal detected.  
 EXT TONE }

## 2. DATA PUMP FROM HOST TO CODEC (Playback from Host to Codec)

### Command (C1):

0010	11	000	MODE	00000
(15 - 12)	(11 - 10)	(9 - 7)	(6 - 5)	(4 - 0)

Mode: 00 - Playback compressed data.  
 01 - Playback  $\mu$ -law/A-law PCM data.

### Status (S1):

0010	11	000	MODE	00000
(15 - 12)	(11 - 10)	(9 - 7)	(6 - 5)	(4 - 0)

### Command (C2):

0010	00000000000
(15 - 12)	(11 - 0)

### Status (S2):

0010	000000	EXT TONE	TONE	DTMF
(15 - 12)	(11 - 6)	(5)	(4)	(3 - 0)

TONE = 1: Call Progress Tone detected.  
 DTMF: } Code of valid DTMF or CAS signal detected.  
 EXT TONE: }

## D6571E Data Sheet

### Command (C3):

0010	0000	NUMBER OF BYTES (for compressed data) NUMBER OF WORDS (for $\mu$ /A-law PCM data)
(15 - 12)	(11 - 8)	(7 - 0)

NUMBER OF BYTES - Indicates the number of bytes that the Host plans to write to the D6571E. This number should generally be set to the maximum number of bytes per frame for compressed data (48).

NUMBER OF WORDS - Indicates the number of bytes that the Host plans to write to the D6571E. This number should generally be set to the maximum number of words per frame for  $\mu$ -law/A-law PCM data (120).

### Status (S3):

0010	0	IND	00	TRANSFER NUMBER OF BYTES (compressed data) TRANSFER NUMBER OF WORDS ( $\mu$ /A-law PCM data)
(15 - 12)	(11)	(10)	(9 - 8)	(7 - 0)

TRANSFER NUMBER OF BYTES - Indicates the number of bytes of compressed that the D6571E will accept from the Host. This number is generally a value between 2 and 48.

TRANSFER NUMBER OF WORDS- Indicates the number of words of  $\mu$ -law/A-law data that the D6571E will accept from the Host. This number is 120.

IND (Insufficient Data) - Indicates that the Host is going to transmit to the D6571E less data bytes than necessary for decompression. If the Host is going to transmit less data than necessary for decompression, the D6571E will not accept this data. In this case, the D6571E will respond with TRANSFER NUMBER OF BYTES set to 00000000 and will skip the byte transfer phase. The D6571E will play silence if there is an inadequate amount of data for decompression. The PAUSE function can be implemented by using this feature.

If the IND bit is not set to '1', then the Host can transfer data to the D6571E. After the Host receives status S3, the actual data transfer begins. The descriptions of the TrueSpeech and  $\mu$ -law/A-law PCM data pumps are given below.

### TrueSpeech Data Pump:

The Host sends the high byte of the command word (which contains data) to the D6571E. The D6571E echoes the received data in the high byte of the status word (Data Transfer status). During the data transfer phase, the HI\LO pin (pin 4) should be set to high.

### Data Transfer Command:

(DC1 . . . DC\_Transfer\_Number\_of\_Bytes for TrueSpeech Data Pump)

DATA BYTE
-----------

(15 - 8)

### Data Transfer Status:

(DS1 . . . DS\_Transfer\_Number\_of\_Bytes for TrueSpeech Data Pump)

ECHO OF DATA BYTE
-------------------

(15 - 8)

## D6571E Data Sheet

### *m-law/A-law PCM Data Pump:*

The Host sends the command word (which contains data) to the D6571E. The D6571E echoes the received data in the status word (Data Transfer status).

#### **Data Transfer Command:**

(DC1 . . . DC\_120)



(15 - 0)

#### **Data Transfer Status:**

(DS1 . . . DS\_120)



(15 - 0)

For both TrueSpeech and  $\mu$ -law/A-law PCM data pumps, in each frame the Host issues command C2, reads status S2, then issues command C3. The actual data transfer starts after S3 is received by the Host. After data transfer is completed the Host should issue the next C2 command. The D6571E checks bits 15 -12 in each C2 and C3 command for the correct code. If an incorrect code is detected, the D6571E will return to Idle mode.

**NOTE:** Instead of sending the Data Pump C2 command shown above, the Host can send a Set Volume Level command to set the volume level. The D6571E will respond with status S2 of Data Pump mode. The 'Set Volume C2 Command' and status S2 are shown below.

#### **Command (C2): Set Volume**

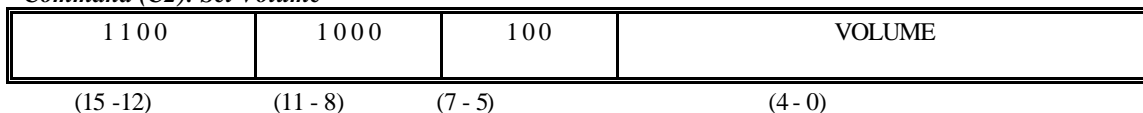

For the appropriate VOLUME level settings, please refer to the Set Volume Level command of the Self Test and Initialization mode (Test Mode = 1000).

#### **Status (S2): Set Volume**

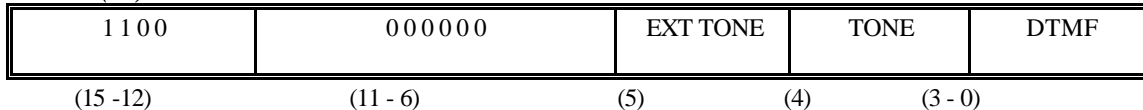

TONE           = 1: Call Progress Tone detected.  
 DTMF           } : Code of valid DTMF or CAS signal detected.  
 EXT TONE       }

## D6571E Data Sheet

### 3. DATA STORAGE (From Host to Flash)

#### Command (C1):

1111	00	BIN	00000 0000
(15 - 12)	(11-10)	(9)	(8-0)

#### Status (S1):

1 1 1 1	00	BIN	0	MEMORY FULL	0 0 0 0 0 0
(15 - 12)	(11 - 10)	(9)	(8)	(7)	(6 - 0)

BIN = 0: Voice message storage  
 = 1: Binary file

MEMORY FULL = 1: Memory full condition has been reached.

**Note:** Data Storage is not available for PCM messages.

#### BINARY = 0

#### Command (C2):

0 0 1 0	0 0 0 0	NUMBER OF BYTES
(15 - 12)	(11 - 8)	(7 - 0)

NUMBER OF BYTES - Indicates the number of bytes that the Host is going to transmit to the D6571E. In general, the Host should plan to send the maximum number of bytes in one frame (48), and the D6571E will respond by informing the Host the actual number of bytes that will be accepted.

#### Status (S2):

0 0 1 0	0	IND	0 0	TRANSFER NUMBER OF BYTES
(15 - 12)	(11)	(10)	(9 - 8)	(7 - 0)

TRANSFER NUMBER OF BYTES - Indicates the number of bytes that the D6571E will accept from the Host.

IND (Insufficient Data) - Indicates that the Host is going to transmit to the D6571E less data bytes than are necessary. If the Host is going to transmit less data than is necessary, the D6571E will not accept this data and respond with TRANSFER NUMBER OF BYTES = 0.

If the IND bit is not set to '1', then the Host can transfer data to the D6571E. After the Host receives status S2, the actual data transfer begins. The Host sends the high byte of the command word (which contains a byte of data) to the D6571E. The D6571E echoes the received data in the high byte of the status word (Data Transfer status). During the data transfer phase, the HI\LO pin (pin 4) should be set to high.

## D6571E Data Sheet

### Data Transfer Command:

(DC1 . . . DC\_Transfer\_Number\_of\_Bytes)



(15 - 8)

### Data Transfer Status:

(DS1 . . . DS\_Transfer\_Number\_of\_Bytes)



(15 - 8)

Each frame the Host issues C1 and C2 commands. The actual data transfer starts after S2 is received by the Host. The D6571E checks bits 15 -12 in each C1 and C2 command for the correct code. If an incorrect code is detected, the D6571E will return to Idle mode. To exit this mode, the D6571E should issue an IDLE command. When an IDLE command is received, the D6571E will update the message directory and return to Idle mode.

### BINARY = 1

#### Command (C2):



(15 - 12)

(11 - 8)

(7 - 0)

NUMBER OF WORDS - Indicates the number of words that the Host is going to transmit to the D6571E. In all frames but the last one, the Host should send the maximum number of words (16). The D6571E will send a confirmation to accept 16 words. The last frame of the binary file may have any number of words.

#### Status (S2):

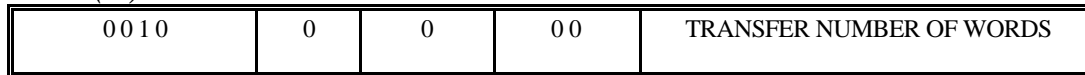

(15 - 12)

(11)

(10)

(9 - 8)

(7 - 0)

TRANSFER NUMBER OF WORDS - Indicates the number of words that the D6571E will accept from the Host.

After the Host receives status S2, the actual data transfer begins. The Host sends the command word (which contains a word of data) to the D6571E. The D6571E echoes the received data in the status word (Data Transfer status).

### Data Transfer Command:

(DC1 . . . DC\_Transfer\_Number\_of\_Words)



(15 - 0)

### Data Transfer Status:

(DS1 . . . DS\_Transfer\_Number\_of\_Words)



(15 - 8)

## D6571E Data Sheet

Each frame the Host issues C1 and C2 commands. The actual data transfer starts after S2 is received by the Host. The D6571E checks bits 15 -12 in each C1 and C2 command for the correct code. If an incorrect code is detected, the D6571E will return to Idle mode. To exit this mode, the D6571E should issue an IDLE command. When an IDLE command is received, the D6571E will update the message directory and return to Idle mode.

### 4. DATA RETRIEVAL (From Flash to Host)

#### Command (C1):

1 1 1 1	1 0	0 0 0	MESSAGE NUMBER
(15 - 12)	(11 - 10)	(9 - 7)	(6 - 0)

#### Status (S1):

1 1 1 1	1 0	BIN	0	END OF MESSAGE	MESSAGE NUMBER
(15 - 12)	(11 - 10)	(9)	(8)	(7)	(6 - 0)

BIN = 0: voice message  
 = 1: binary message

END OF MESSAGE = 1 - End of message has been reached.

**Note:** Data Retrieval is not available for PCM messages

#### BIN = 0

#### Command (C2):

0 0 0 1	0 0 0 0	NUMBER OF BYTES
(15 - 12)	(11 - 8)	(7 - 0)

NUMBER OF BYTES - Indicates the number of bytes that the Host expects to receive from the D6571E.

#### Status (S2):

0 0 0 1	0 0 0 0	TRANSFER NUMBER OF BYTES
(15 - 12)	(11 - 8)	(7 - 0)

TRANSFER NUMBER OF BYTES - Indicates the actual number of bytes that the D6571E will write to the Host.

After the Host receives status S2, the actual data transfer begins. The Host sends the high byte of the Data Transfer command to the D6571E. The D6571E responds with compressed data in the high byte of the status word (Data Transfer status). During the data transfer phase, the HI\LO pin (pin 4) should be set to high.



## D6571E Data Sheet

### Data Transfer Command:

(DC1 ... DC\_Transfer\_Number\_of\_Bytes)

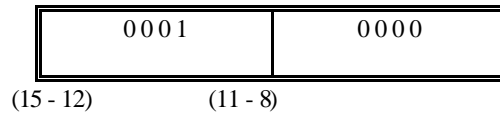

### Data Transfer Status:

(DS1 ... DS\_Transfer\_Number\_of\_Bytes)



Each frame the Host issues C1 and C2 commands. The actual data transfer starts after status S2 is received by the Host. The D6571E checks bits 15-12 in each C1 and C2 command for the correct code. If an incorrect code is detected, the D6571E will return to Idle mode. The Host should send an IDLE command to exit this mode.

### BIN = 1

#### Command (C2):

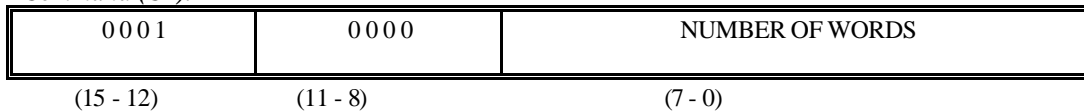

NUMBER OF WORDS - Indicates the number of words that the Host expects to receive from the D6571E. Supposed to be 16 in this mode.

#### Status (S2):

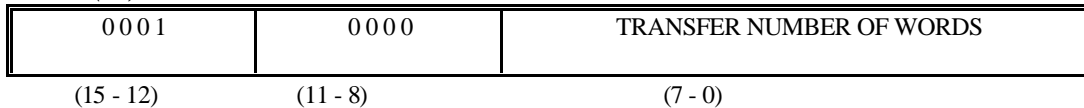

TRANSFER NUMBER OF WORDS - Indicates the actual number of words that the D6571E will write to the Host. Expected to be 16 for each frame but the last one. The last frame may have any number of words from 1 to 16. After the Host receives status S2, the actual data transfer begins. The Host sends the Data Transfer command to the D6571E. The D6571E responds with binary data in the status word (Data Transfer status).

### Data Transfer Command:

(DC1 ... DC\_Transfer\_Number\_of\_Words)

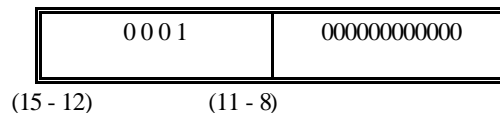

### Data Transfer Status:

(DS1 ... DS\_Transfer\_Number\_of\_Words)

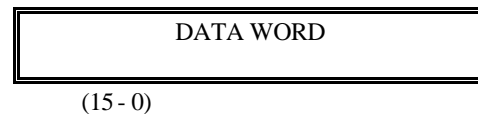

## D6571E Data Sheet

Each frame the Host issues C1 and C2 commands. The actual data transfer starts after status S2 is received by the Host. The D6571E checks bits 15-12 in each C1 and C2 command for the correct code. If an incorrect code is detected, the D6571E will return to Idle mode. The Host should send an IDLE command to exit this mode.

### 5. DATA COMPRESSION (From Host to Host)

#### Command (C1):

1 1 1 1	0 1	MODE	0 0	GAP	0 0 0 0
(15 - 12)	(11 - 10)	(9 - 7)	(6 - 5)	(4)	(3 - 0)

MODE: = 000: low bit rate  
 = 001: middle bit rate  
 = 010: high bit rate  
 = Else: Reserved

GAP: = 0: gap coding is disabled  
 = 1: gap coding is activated

#### Status (S1):

1 1 1 1	0 1	MODE	0 0	GAP	0 0 0 0
(15 - 12)	(11 - 10)	(9 - 7)	(6 - 5)	(4)	(3 - 0)

#### Command (C2):

0 0 1 0	0 0 0 0	NUMBER OF WORDS
(15 - 12)	(11 - 8)	(7 - 0)

NUMBER OF WORDS - Indicates the number of words that the Host plans to transmit to the D6571E. In general, the Host should plan to send the maximum number of words (160). The D6571E will respond by informing the Host the actual number of words that will be accepted.

#### Status (S2):

0 0 1 0	0	IND	0 0	TRANSFER NUMBER OF WORDS
(15 - 12)	(11)	(10)	(9 - 8)	(7 - 0)

TRANSFER NUMBER OF WORDS - Indicates the number of words that the D6571E will accept from the Host. Should be 160 in this mode.

IND (Insufficient Data) - Indicates that the number of words that the Host is going to transmit to the D6571E is less than necessary for compression. If this is the case, IND will be set to '1', TRANSMIT NUMBER OF WORDS will be set to 00000000, and the D6571E will skip the word transfer phase.

If IND is not set to '1', then the Host can transmit data to the D6571E after receiving status S2. The Host will transmit the data by sending a Data Transfer Command. The D6571E will respond with echo of this word (Data Transfer Status).

## D6571E Data Sheet

### Data Transfer Command:

(DC1 . . . DC\_Transfer\_Number\_of\_Words)

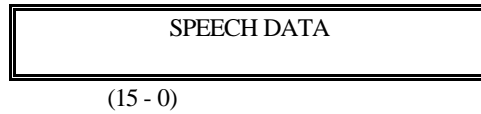

### Data Transfer Status:

(DS1 . . . DS\_Transfer\_Number\_of\_Words)

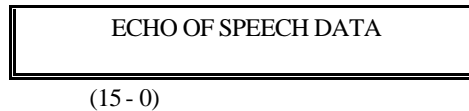

### Command (C3):

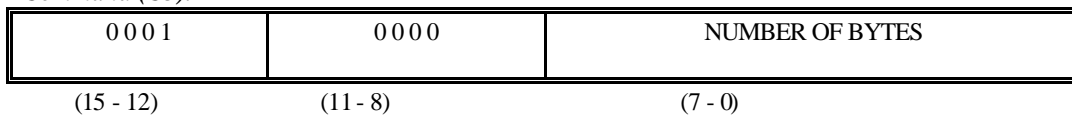

NUMBER OF BYTES - Indicates the number of bytes that the Host expects to read from the D6571E. In general, the Host should set this number to the maximum number of bytes per frame (48).

### Status (S3):

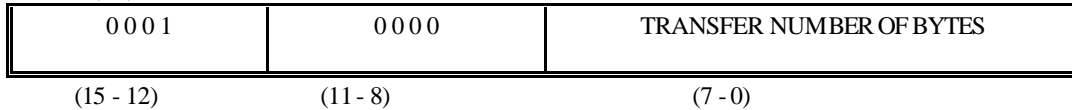

TRANSFER NUMBER OF BYTES - Indicates the actual number of bytes the D6571E will send to the Host.

After the Host receives status S3, the actual data transfer begins. The Host sends the high byte of the Data Transfer command. The D6571E responds with compressed data in the high byte of the status word (Data Transfer status). During the data transfer phase, the HI\LO pin (pin 4) should be set to high.

### Data Transfer Command:

(DC1 . . . DC\_Transfer\_Number\_of\_Bytes)

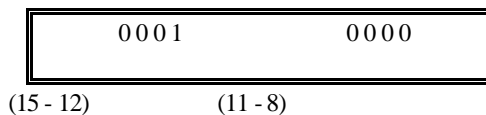

### Data Transfer Status:

(DS1 . . . DS\_Transfer\_Number\_of\_Bytes)



Each frame the Host issues command C2 and receives status S2. Upon receiving S2, the Host starts transmitting uncompressed data to the D6571E. After data has been transferred to the D6571E the Host issues command C3. The D6571E will accept this command and return status S3 upon completion of the compression of the current frame. Upon receiving status S3 the Host starts data transfer from the D6571E. Then the Host issues the next command C1 to start processing the next frame. The D6571E checks bits 15-12 in each C1, C2, and C3 command for the correct code. If an incorrect code is detected, the D6571E will exit Data Pump mode and return to Idle mode.

## D6571E Data Sheet

### 6. DATA DECOMPRESSION (From Host to Host)

#### Command (C1):



#### Status (S1):



#### Command (C2):

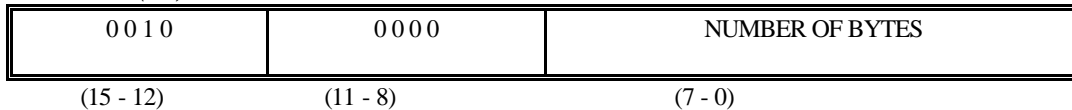

NUMBER OF BYTES - Indicates the number of bytes that the Host will transmit to the D6571E (should be 48).

#### Status (S2):

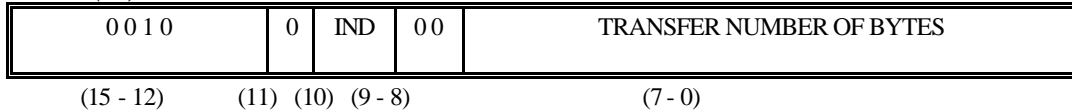

TRANSFER NUMBER OF BYTES - Indicates the number of bytes that the D6571E will accept from the Host

IND (Insufficient Data) - Indicates that the number of bytes that the Host will transmit is less bytes than necessary for decompression. When there is an inadequate number of bytes, the D6571E will respond with TRANSFER NUMBER OF BYTES equal to 00000000 and set IND equal to '1'. As a result, the byte transfer phase will be skipped.

If IND was not set to '1' in S2, then the Host begins data transfer to the D6571E. The Host sends the byte of data in the high byte of the Data Transfer command. The D6571E echoes the received data in the high byte of the status word (Data Transfer status). During the data transfer phase, the HI\LO pin (pin 4) should be set to high.

#### Data Transfer Command:

(DC1 . . . DC\_Transfer\_Number\_of\_Bytes)



#### Data Transfer Status:

(DS1 . . . DS\_Transfer\_Number\_of\_Bytes)



## D6571E Data Sheet

### Command (C3):

0 0 0 1	0 0 0 0	NUMBER OF WORDS
(15 - 12)	(11 - 8)	(7 - 0)

NUMBER OF WORDS - Indicates the number of words that the Host expects to read from the D6571E. This number should be set to the maximum number of words (160).

### Status (S3):

0 0 0 1	0 0 0 0	TRANSFER NUMBER OF WORDS
(15 - 12)	(11 - 8)	(7 - 0)

TRANSFER NUMBER OF WORDS - Indicates the actual number of words that the D6571E will send to the Host. This number should have a value 160.

After the Host receives status S3 the actual Data Transfer phase begins. The Host sends a Data Transfer command to the Host Data Bus. After receiving this command, the D6571E responds by sending to the Host one word of decompressed data (Data Transfer Status).

### Data Transfer Command:

(DC1 . . . DC\_Transfer\_Number\_of\_Words)

0 0 0 1	0 0 0 0 0 0 0 0 0 0 0 0 0 0 0 0
(15 - 12)	(11 - 0)

### Data Transfer Status:

(DS1 . . . DS\_Transfer\_Number\_of\_Words)

SPEECH DATA
(15 - 0)

Each frame the Host issues command C2 and receives status S2. Upon receiving S2, the Host starts transmitting compressed data to the D6571E. After data has been transferred to the D6571E the Host issues command C3. The D6571E will accept this command and return status S3 upon completion of the decompression of the current frame. Upon receiving status S3 the Host starts data transfer from the D6571E. Then the Host issues the next command C1 to start processing the next frame. The D6571E checks for the correct code in bits 15-12 in each C1, C2, and C3 command. If an incorrect code is detected, the D6571E will exit Data Pump mode and return to Idle mode.

## D6571E Data Sheet

### APPLICATION HINTS

A good printed circuit board (PCB) layout is as important as the overall circuit design itself in achieving high audio quality. To achieve this, the designer has to be conscious of noise both in the D6571E chip and the front-end analog circuitry. Switching mode power supplies are not recommended as the switching spikes will feed through. Other causes of concern are ground loops and digital feed through.

#### Layout Hints

Ensure that the layout for the printed circuit board has digital and analog signal lines separated as much as possible. Take care not to run any digital track along side an analog signal. Guard the analog input with AGND. Establish a single point analog ground separate from the digital ground. Low impedance analog and digital power supply common returns are essential to low noise operation.

#### Power Supply Considerations

Since the D6571E is a chipset with analog input and output, its performance (especially the analog front-end) may be adversely affected by the noise of the power supply. In order to prevent mixing of noise, observe the following cautions:

- Separate the power supply to the digital parts and analog parts.
- GNDs of two power supplies should be connected at

only one point. Furthermore, that connecting point should be close to the supplies. This will minimize the effect of noise from the digital power supply to the analog power supply.

The power supply should have the least ripple possible, and a series regulator power supply is recommended for best operation.

Good engineering practice calls for proper supply decoupling between the various components. This may be achieved by running separate VCC and ground lines to the D6571E and Flash memory and placing 0.1  $\mu\text{F}$  ceramic decoupling capacitors near each  $V_{CC}$  supply pin.

#### Microphone and Speaker Considerations

An often overlooked fact is that the sound quality produced by D6571E chipset is directly related to the quality of the microphone and speaker connected to them. Use a good quality microphone and speaker with good frequency response. Carefully design the microphone preamplifier circuit. The physical location of the microphone, along with the characteristics of the microphone, play a large role in the playback sound quality.

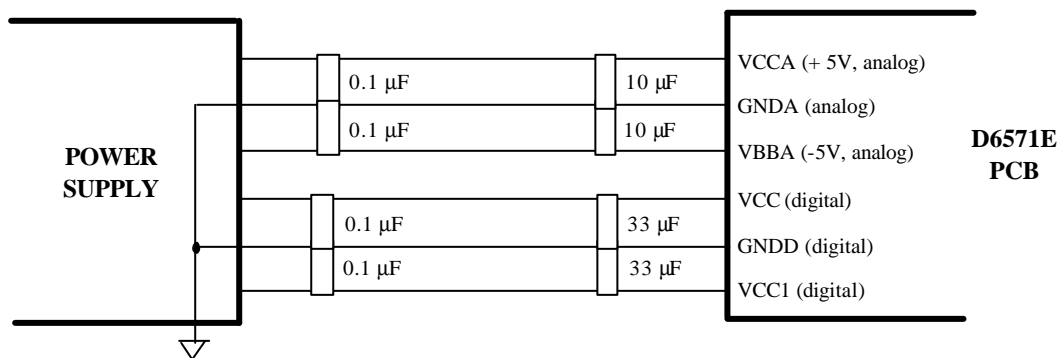

Figure 10. Power Supply

# D6571E Data Sheet

## ELECTRICAL CHARACTERISTICS

### D6571E-11

#### Absolute maximum ratings over specified temperature range

Supply voltage range, $V_{CC}$	-0.3 V to 7 V
Input voltage range	-0.3 V to 7 V
Output voltage range	-0.3 V to 7 V
Operating free-air temperature range	0°C to 70°C
Storage temperature range	-55°C to 150 °C

#### 5 V OPERATION

#### Recommended operating conditions

	MIN	TYP	MAX	UNIT
$V_{CC}$ Supply voltage	4.5	5	5.5	V
$V_{SS}$ Supply voltage		0		V
$V_{IH}$ High-level input voltage (all pins except HSTWR)	2.2			V
$V_{IH}$ High-level input voltage (HSTWR)	2.6			V
$V_{IL}$ Low-level input voltage			0.8	V
VT+ Positive-going RESET and PDN threshold		$V_{CC} - 0.5$ V		V
VT- Negative-going RESET and PDN threshold		1.1		V
$I_{OH}$ High-level output current			+4	mA
$I_{OL}$ Low-level output current			-4	mA
Crystal oscillator (100 ppm)		40.960 or 36.864		MHz
$T_A$ Operating free-air temperature	0		70	°C

#### Electrical characteristics over recommended operating free-air ranges (unless otherwise noted)

PARAMETERS	TEST CONDITIONS	MIN	TYP	MAX	UNIT
$V_{OH}$ High-level output voltage	$V_{CC} = 5V$	2.6			V
$V_{OL}$ Low-level output voltage				0.4	V
$I_{OZ}$ Off-state output current				±10	µA
$I_{CC}$ Supply current	Operating Mode	$f = 40.960$ MHz; $V_{CC} = 5V$		90	mA
	Suspend Mode **			5	mA
$C_I$ Input capacitance				20	pF

\*\* No battery backup is required to retain data in the case of power failure. Suspend mode may be used to conserve power.

## D6571E Data Sheet

### 3.3 V OPERATION

#### Recommended operating conditions

	MIN	TYP	MAX	UNIT
V <sub>CC</sub> Supply voltage	3.0	3.3	3.6	V
V <sub>SS</sub> Supply voltage		0		V
V <sub>IH</sub> High-level input voltage	2.0			V
V <sub>IL</sub> Low-level input voltage			0.6	V
VT+ Positive-going RESET and PDN threshold		V <sub>CC</sub> - 0.25 V		V
VT- Negative-going RESET and PDN threshold		0.7		V
I <sub>OH</sub> High-level output current			+2	mA
I <sub>OL</sub> Low-level output current			-2	mA
Crystal oscillator (100 ppm)		40.960 or 36.864		MHz
T <sub>A</sub> Operating free-air temperature	0		70	°C

#### Electrical characteristics over recommended operating free-air ranges (unless otherwise noted)

PARAMETERS	TEST CONDITIONS	MIN	TYP	MAX	UNIT
V <sub>OH</sub> High-level output voltage	V <sub>CC</sub> = 3.3V	2.4			V
V <sub>OL</sub> Low-level output voltage				0.4	V
I <sub>OZ</sub> Off-state output current				±10	μA
I <sub>CC</sub> Supply current	Operating Mode	f = 40.960 MHz; V <sub>CC</sub> = 3.3V			mA
	Suspend Mode **		3.5		mA
C <sub>I</sub> Input capacitance				20	pF

\*\* No battery backup is required to retain data in the case of power failure. Suspend mode may be used to conserve power.



## D6571E Data Sheet

### D0000-29 (CODEC)

#### Absolute maximum ratings over specified temperature range

Supply voltage range, $V_{CC}$	-0.3 V to 7 V
Output voltage, $V_O$	-0.3 V to 7 V
Input voltage, $V_I$	-0.3 V to 7 V
Digital ground voltage	-0.3 V to 7 V
Operating free-air temperature range	0°C to 70°C

#### Recommended operating conditions

	MIN	TYP	MAX	UNIT
$V_{CC}$ Supply voltage	4.75	5	5.25	V
$V_{BB}$ Supply voltage	-4.75	-5	-5.25	V
$V_{IH}$ High-level input voltage, all inputs except CLKSEL	2.2			V
$V_{IL}$ Low-level input voltage, all inputs except CLKSEL			0.6	V
$R_L$ Load resistance	No change transmit	10		k $\Omega$
	At VFRO Receive	600		$\Omega$
$C_L$ Load capacitance	At GSX		50	pF
	At VFRO		500	
$T_A$ Operating free-air temperature	0		70	°C

#### Electrical characteristics over recommended ranges of supply voltage and operating free-air temperature supply current, $f_{DCLK}$ 2.048 MHz, outputs not loaded

PARAMETER		TEST CONDITIONS	TYPE	MAX	UNIT
$I_{CC}$ Supply current from $V_{CC}$	Operating		6	9	mA
	Power-down		0.5	1.5	
$I_{BB}$ Supply Current from $V_{BB}$	Operating		-6	-9	mA
	Power-down		-0.5	-1.5	
Power dissipation	Operating		60	90	mW
	Power-down		5	15	

#### Transmit amplifier input

PARAMETERS	TEST CONDITIONS	MIN	TYP	MAX	UNIT
Input current at ANLG IN+, ANLG IN-	$V_I = -2.17$ V to 2.17 V			$\pm 200$	nA
Input offset voltage at ANLG IN+, ANLG IN-	$V_I = -2.17$ V to 2.17 V			$\pm 20$	mV
Common-mode rejection at ANLG IN+, ANLG IN-	$V_I = -2.17$ V to 2.17 V	60			dB
Open-loop voltage amplification at GSX		5000			V/V
Open-loop unity-gain bandwidth at GSX			2		MHz
Input resistance at ANLG IN+, ANLG IN-		10			M $\Omega$

#### Receive filter output

PARAMETERS	TEST CONDITIONS	MIN	TYP	MAX	UNIT
Output offset voltage PWRO+, PWRO- (single-ended)	Relative to ANLG GND	-200		200	mV
Output resistance at PWRO+, PWRO-			1		$\Omega$

## D6571E Data Sheet

### DETECTORS CHARACTERISTICS

#### DTMF & VOX CHARACTERISTICS

PARAMETER	MIN	TYP	MAX	UNIT
DTMF Signal level for detection*	-35		0	dB0
DTMF Twist (High/Low Tone)			+4/-8	dB
DTMF Frequency Detect Band width	±(1.5% + 2Hz)		3.5%	%fc
DTMF Noise tolerance**			+12	dB
DTMF tone duration accept	40			ms
DTMF tone duration reject			23	ms
DTMF interdigit pause accept	40			ms
DTMF interdigit pause reject			23	ms
VOX detection*	-37		+6	dB0
Tone generator frequency accuracy	-0.1		+0.1	%fc
Tone generator level***	-24		+6	dB0
Tone generator level accuracy	-0.5		+0.5	dB

#### Call Progress Tone Detector Performance

PARAMETER	MIN	TYP	MAX	UNIT
Detection Level*	-29			dB0
Rejection Level*			-34	dB0
Rejection Frequency Range	800		2500	Hz
Frequency Range	300		640	Hz
Signal Duration Accept	80			ms
Pause Duration Accept	80			ms
Response Time			150	ms
Noise Tolerance	-12			dB

\*0.707 V RMS is defined as the 0 dB0

\*\*BW limited (0-3.0 KHz) Gaussian noise

\*\*\*0dB0 is 0.707V RMS programmable with resolution 2 dB.

#### Caller ID FSK Demodulator Performance

PARAMETER	MIN	TYP	MAX	COMMENTS
Rate of Reception		1200 bps±12 bps		
Signal Level Differential		± 10 dB		
Mark (Logic 1) Bell 202 V.23	1188 Hz 1287 Hz	1200 ± 12 Hz 1300 ± 13 Hz	1212 Hz 1313 Hz	
Space (logic 0) Bell 202 V.23	2187 Hz 2079 Hz	2200 ± 22 Hz 2100 ± 21 Hz	2222 Hz 2121 Hz	
Received Signal Level (Mark)	-32 dBm		-12 dBm	
Received Signal Level (Space)	-36 dBm		-12 dBm	
Signal to Distortion Ratio		≥ 25 dB		

## D6571E Data Sheet

### Caller Alert Signal / Idle State Tone Alert Signal

PARAMETER	MIN	TYP	MAX	UNIT
Detection Level	- 32			dBm
Rejection Level			- 45	dBm
Low Frequency	2130 - 1.1%	2130	2130 + 1.1%	Hz
High Frequency	2750 - 1.1%	2750	2750 + 1.1%	Hz
Twist			+/-7	dB
Duration	75	80	85	ms
SNR*	- 20			dB

\* The CAS detector was tested according to the "Test Plan for CPE Alerting Signal Detectors" SR-TSV-002476. See this document for details.

# D6571E Data Sheet

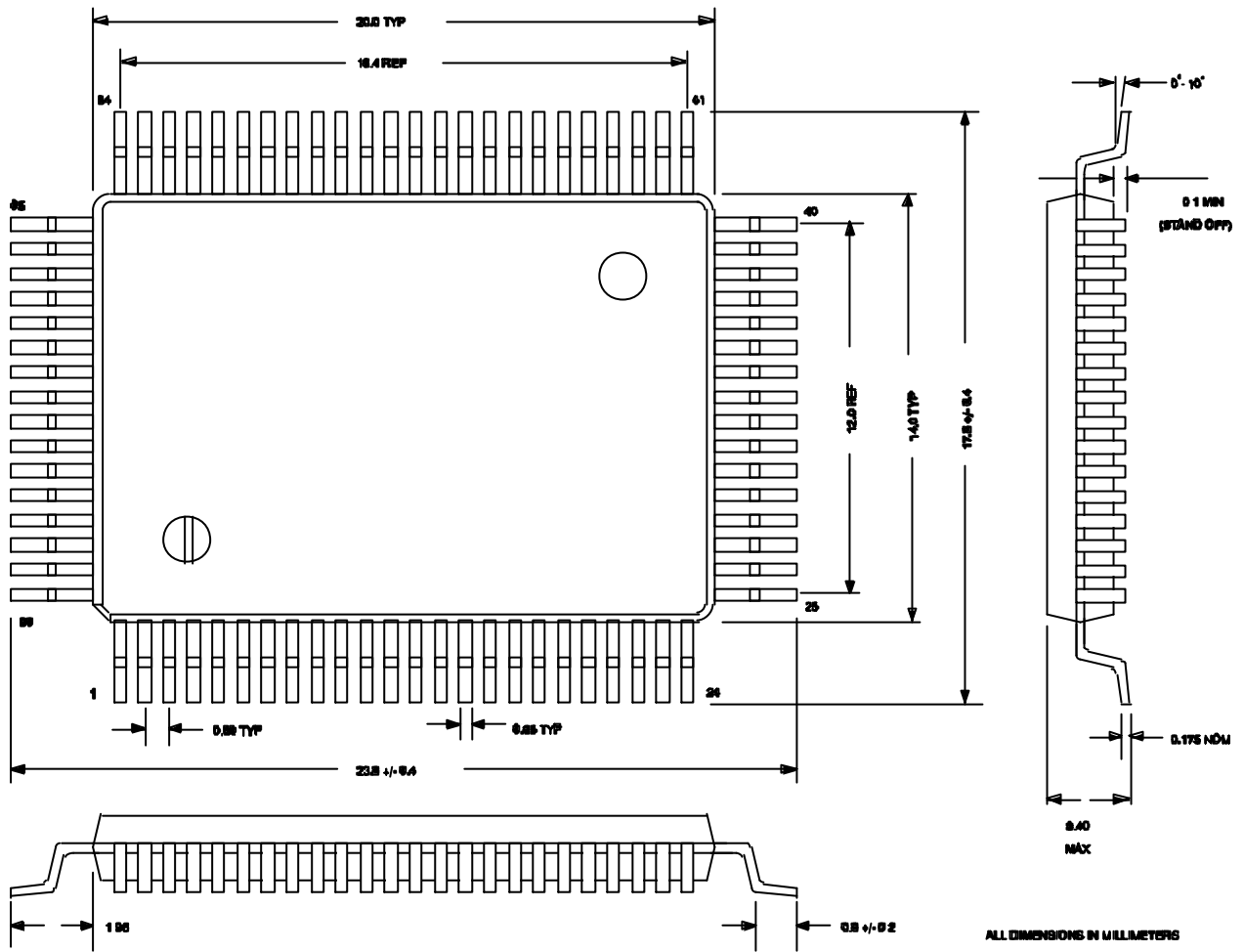
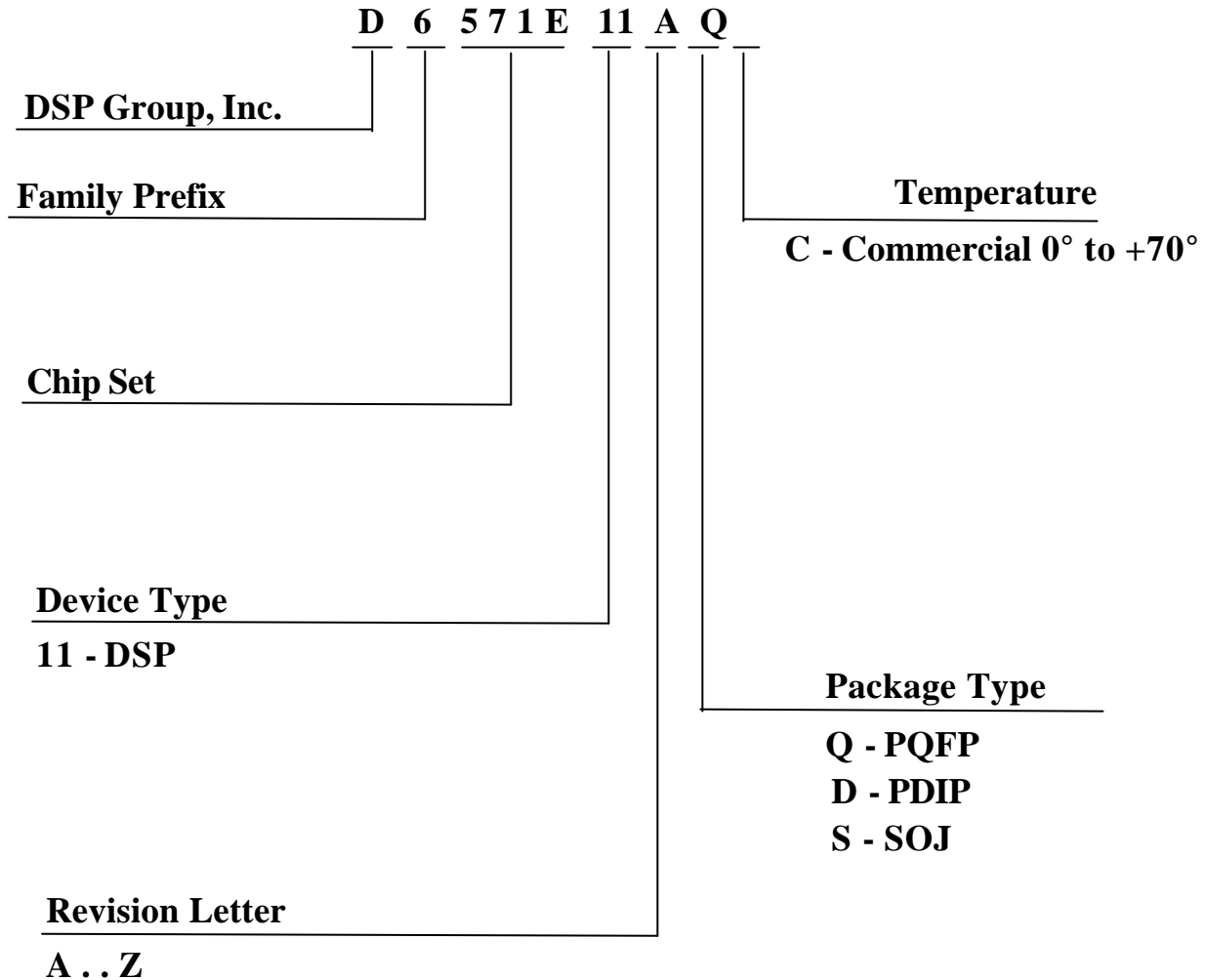

Figure 11. D6571E-11 Mechanical Data

**DSPG CHIP SET PART NUMBER SYSTEM**



<p><b>DSP GROUP, INC.</b></p> <p>3120 Scott Boulevard          Santa Clara, CA 95054          Telephone: (408) 986-4300          Facsimile: (408) 986-4490</p> <p><b>DSP GROUP EUROPE</b></p> <p>18 rue de l' effort mutuel          91300 MASSY          FRANCE          Telephone: (33) 6-07-68-67-54          Facsimile: (33) 1-60-10-51-87</p>	<p><b>JAPAN OFFICE</b></p> <p>Nihon DSP Group, K.K.          Yasuda Kasai Building - 2nd Floor          2-3-1, Higashi Gotanda          Shinagawa-ku, Tokyo 141, Japan          Telephone: (81) 3-3449-7851          Facsimile: (81) 3-3449-8006</p>	<p><b>ASIA PACIFIC TECHNICAL SUPPORT CENTER</b></p> <p>Unit 1923, 19/F Metro Centre 1          32 Lam Hing Street          Kowloon Bay, Kowloon, Hong Kong          Telephone: (852) 2750-7325          Facsimile: (852) 2305-0640</p>
--------------------------------------------------------------------------------------------------------------------------------------------------------------------------------------------------------------------------------------------------------------------------------------------------------------------------------------------------------------------------------	--------------------------------------------------------------------------------------------------------------------------------------------------------------------------------------------------------------------------------------------------------------------------	--------------------------------------------------------------------------------------------------------------------------------------------------------------------------------------------------------------------------------------------------------