

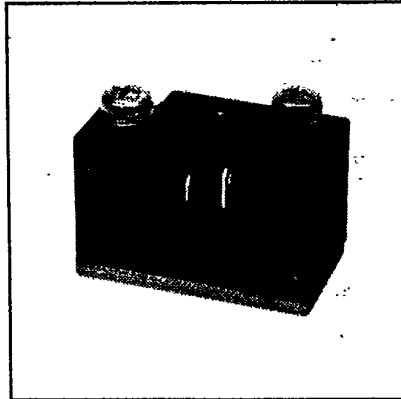

Powerex, Inc., Hillis Street, Youngwood, Pennsylvania 15697 (412) 925-7272

**D67FP**

**Fast Switching  
Single Darlington  
Transistor Module  
100 Amperes  
500-600-700 Volts**

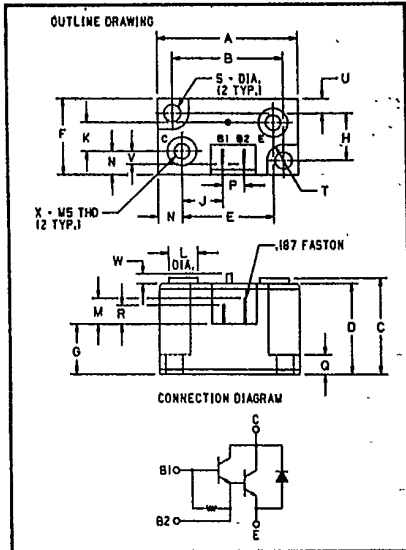

**D67FP**  
**Fast Switching Single Darlington  
Transistor Module**  
100 Amperes/500-600-700 Volts

**500-600-700 Volt D67FP  
Outline Drawing**

Dimension	Inches	Millimeters
A	1.800 ± .015	45.7 ± 0.4
B	1.420 ± .010	36 ± 0.25
C	1.242 ± .030	31.55 ± 0.8
D	1.173 ± .025	29.8 ± 0.6
E	1.170	29.7
F	1.000 ± .015	25.4 ± 0.4
G	.650 ± .035	16.5 ± 0.9
H	.620 ± .010	15.7 ± 0.25
J	.518	13.2
K	.380 ± .010	9.6 ± 0.25
L	.375 Dia.	9.5 Dia.
M	.335	8.5
N	.310 ± .010	7.9 ± 0.25
P	.275 ± .015	7 ± 0.4
Q	.250 ± .015	6.4 ± 0.4
R	.245	6.2
S	.22 Dia.	5.6 Dia.
T	.21 R	5.3 R
U	.180	4.6
V	.170	4.3
W	.120	3.1
X	M5 Metric	M5

**Description**

Powerex Fast Switching Single Darlington Transistor Modules are designed for use in switching applications. The modules are isolated consisting of one Darlington Transistor with a reverse parallel connected high-speed diode.

**Features:**

- Isolated Mounting
- Fast Switching
- Discrete Fast Recovery Feed-Back Diode
- High Gain (h<sub>FE</sub>)
- Base 1 and 2 Accessible

**Applications:**

- PWM Inverters
- DC Motor Control
- Switching Power Supplies
- AC Motor Control

**Ordering Information**

Example: Select the complete six digit module part number you desire from the table - i.e. D67FP7 is a 700 Volt, 100 Ampere Fast Switching Single Darlington Module.

Type	V <sub>CEV</sub> Volts (×100)	Current Rating Amperes (100)
D67FP	5	100
D67FP	6	100
D67FP	7	100



Powerex, Inc., Hillis Street, Youngwood, Pennsylvania 15697 (412) 925-7272

**D67FP**

**Fast Switching Single Darlington Transistor Module**  
100 Amperes/500-600-700 Volts

**Maximum Ratings  $T_J = 25^\circ\text{C}$  unless otherwise specified**

	Symbol	D67FP	Units
Junction Temperature	$T_J$	-40 to 150	$^\circ\text{C}$
Storage Temperature	$T_{STG}$	-40 to 125	$^\circ\text{C}$
Collector-Emitter Sustaining Voltage D67FP5	$V_{CE0(SUS)}$	400	Volts
Collector-Emitter Voltage $V_{BE} = -1.5\text{V}$ D67FP5	$V_{CEV}$	500	Volts
Collector-Emitter Sustaining Voltage D67FP6	$V_{CE0(SUS)}$	450	Volts
Collector-Emitter Voltage $V_{BE} = -1.5\text{V}$ D67FP6	$V_{CEV}$	600	Volts
Collector-Emitter Sustaining Voltage D67FP7	$V_{CE0(SUS)}$	500	Volts
Collector-Emitter Voltage $V_{BE} = -1.5\text{V}$ D67FP7	$V_{CEV}$	700	Volts
Emitter-Base Voltage	$V_{EBO}$	7	Volts
Continuous Collector Current	$I_C$	100	Amperes
Peak (Repetitive) Collector Current	$I_{CM}$	150	Amperes
Peak (Non-repetitive) Collector Current	$I_{CSM}$	250	Amperes
Diode Forward Current	$I_{FM}$	100	Amperes
Continuous Base Current	$I_B$	10	Amperes
Peak (Non-repetitive) Base Current	$I_{BM}$	20	Amperes
Power Dissipation	$P_T$	312.5	Watts
Max. Mounting Torque (M5) Terminal Screws	---	28	in.-lb.
Max. Mounting Torque (M5) Mounting Screws	---	25	in.-lb.
V Isolation	$V_{RMS}$	2500	Volts



Powerex, Inc., Hillis Street, Youngwood, Pennsylvania 15697 (412) 925-7272

**D67FP**

**Fast Switching Single Darlington Transistor Module**  
100 Amperes/500-600-700 Volts

**Electrical and Mechanical Characteristics  $T_j = 25^\circ\text{C}$  unless otherwise specified**

Characteristics	Symbol	Test Conditions	Min.	D67FP Typ.	Max.	Units
Collector Cutoff Current	$I_{CEV}$	$V_{CE} = V_{CEV}(\text{rated}), V_{BE} = -1.5\text{V}$	—	—	1	mA
Collector Cutoff Current	$I_{CEV}$	$V_{CE} = V_{CEV}(\text{rated}), V_{BE} = -1.5\text{V}$ $T_C = 150^\circ\text{C}$	—	—	2.5	mA
Emitter Cutoff Current	$I_{EBO}$	$V_{EB} = 5\text{V}$	—	—	10	mA
DC Current Gain	$h_{FE}$	$I_C = 150\text{A}, V_{CE} = 5.0\text{V}$ $I_C = 100\text{A}, V_{CE} = 5.0\text{V}$ $I_C = 40\text{A}, V_{CE} = 5.0\text{V}$	25 50 100	150 300 350	—	—
Collector-Emitter Saturation Voltage	$V_{CE(\text{SAT})}$	$I_C = 150\text{A}, I_B = 10.0\text{A}$ $I_C = 100\text{A}, I_B = 8.0\text{A}$ $I_C = 40\text{A}, I_B = 4.0\text{A}$	—	1.9 1.3 0.8	3.0 2.0 1.5	V V V
Base-Emitter Saturation Voltage	$V_{BE(\text{SAT})}$	$I_C = 150\text{A}, I_B = 10.0\text{A}$ $I_C = 100\text{A}, I_B = 8.0\text{A}$	—	2.75 2.3	3.5 3.0	V V
Delay Time*	$t_d$	$V_{CC} = 250\text{V}$	—	0.1	0.5	$\mu\text{s}$
Rise Time*	$t_r$	$I_C = 100\text{A}$	—	0.45	1.0	$\mu\text{s}$
Storage Time*	$t_s$	$I_{B1} = 5\text{A}, -I_{B2} = 10.0\text{A}$	—	3.2	5.0	$\mu\text{s}$
Fall Time*	$t_f$	$t_p = 50 \mu\text{sec}$	—	1.0	3.0	$\mu\text{s}$
Diode Forward Voltage	$V_{FM}$	$I_{FM} = 100\text{A}$	—	1.3	2.0	V
Reverse Recovery Time	$t_{rr}$	$I_{FM} = 100\text{A}, di/dt = 100\text{A}/\mu\text{sec}$ $V_{BE} = -1.5\text{V}$	—	0.5	1.0	$\mu\text{s}$
Thermal Resistance, Junction to Case	$R_{\theta JC}$	Transistor Part	—	—	4	$^\circ\text{C/W}$
Thermal Resistance, Junction to Case	$R_{\theta JC}$	Diode Part	—	—	1.5	$^\circ\text{C/W}$

\*Resistive Load



Powerex, Inc., Hillis Street, Youngwood, Pennsylvania 15697 (412) 925-7272

**D67FP**  
Fast Switching Single Darlington Transistor Module  
100 Amperes/500-600-700 Volts

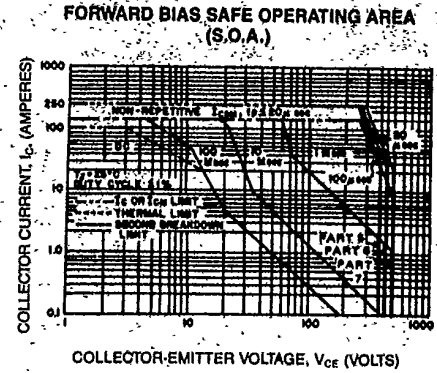
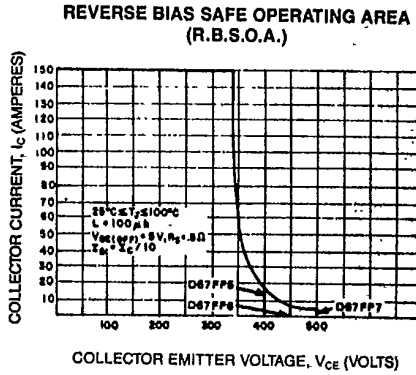
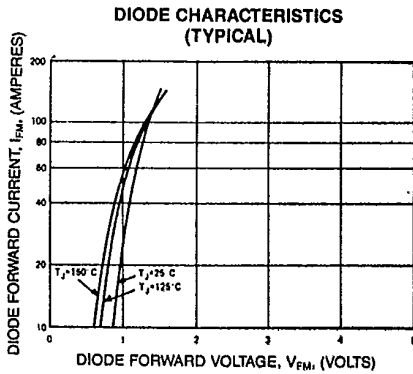
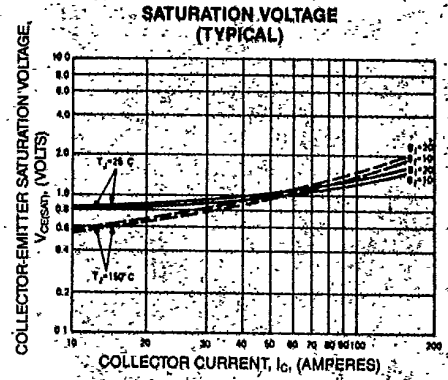
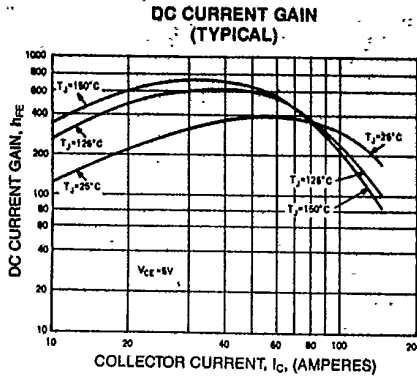
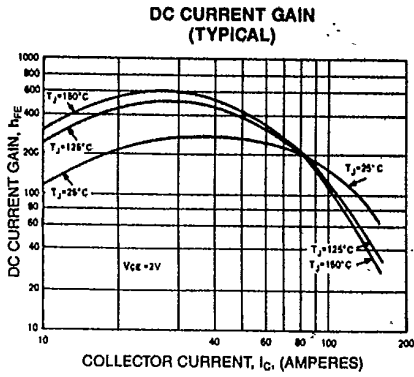

**Switching Time Test Circuit**

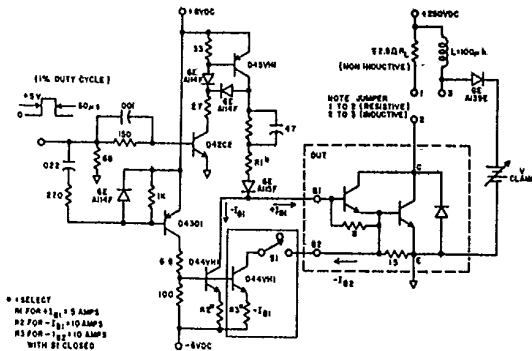

NOTE: UTILIZING SECOND BASE CONNECTION DURING TURN-OFF (S1 CLOSED), TYPICAL REDUCTIONS IN TURN-OFF TIMES ( $t_{off}$ ,  $t_{f}$ ) RANGE FROM 8:1 TO 10:1. REDUCTION IS PROPORTIONAL TO  $t_{off}^{-1}$ .

- \* SELECT
- R1 FOR  $I_{B1}$  = 5 AMPS
- R2 FOR  $I_{B1}$  = 10 AMPS
- R3 FOR  $I_{B1}$  = 10 AMPS
- WITH S1 CLOSED