

### Multi DomiLED

Synonymous with function and performance, the Multi DomiLED series is perfectly suited for a variety of cross-industrial applications due to its small package outline, durability and superior brightness.

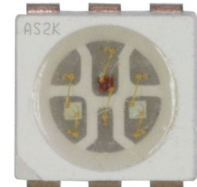

### Features:

- > High brightness tri-color surface mount LED.
- > Each color can be individually controlled
- > 120° viewing angle.
- > Small package outline (LxWxH) of 3.2 x 3.0 x 1.7mm.
- > Qualified according to JEDEC moisture sensitivity Level 2.
- > Compatible to IR reflow soldering.
- > Environmental friendly; RoHS compliance.
- > Superior Corrosion Resistant.
- > Compliance to automotive standard; AEC-Q101.



### Applications:

- > Automotive: Interior applications, eg: switches, telematics, climate control system, dashboard, etc.
- > Signs: full color video
- > Consumer & Communication: backlighting of LCDs
- > General Lighting: architectural lighting, decorative lighting



**Optical Characteristics at Tj=25°C**

Part Ordering Number	Color, $\lambda_{dom}$ (nm)			Luminous Intensity @ If = 20mA IV (mcd) <small>Appx. 1.1</small>		
	Chip #1	Chip #2	Chip #3	Chip #1	Chip #2	Chip #3
D6RTB-SKG-U3V3+W2X+S2T-1	Red 625nm	True Green 528nm	Blue 465nm	650.0-1280.0	1400.0-2850.0	224.0-450.0

**Electrical Characteristics at Tj=25°C**

	$V_f$ @ If = 20mA <small>Appx. 3.1</small>			$V_r$ @ Ir = 10uA
	Min. (V)	Typ. (V)	Max. (V)	Min. (V)
Red	1.90	2.20	2.50	12
True Green	2.65	3.00	3.30	5
Blue	2.65	3.00	3.30	5

**Absolute Maximum Ratings**

	Maximum Value	Unit
DC forward current	Red; AllInGaP=50; True Green, Blue; InGaN=50	mA
Peak pulse current; (tp ≤ 10μs, Duty cycle = 0.005)	Red ; AllInGaP=200 True Green, Blue; InGaN=200	mA
Reverse voltage	Red; AllInGaP=12; True Green, Blue; InGaN= 5	V
ESD threshold (HBM)	2000	V
LED junction temperature	125	°C
Operating temperature	-40 ... +115	°C
Storage temperature	-40 ... +125	°C
Thermal resistance (1 chips on)		
- Real Thermal Resistance		
Junction / ambient, R <sub>th JA real</sub>		
Red	360	K/W
Blue & True Green	390	K/W
Junction / solder point, R <sub>th JS real</sub>		
Red	160	K/W
Blue & True Green	170	K/W
(Mounting on DOMINANT standard PCB)		

## Wavelength Grouping

Color	Group	Wavelength distribution (nm) <small>Appx. 2.2</small>
Red	Full	619 - 629
True Green	Full	520 - 535
	A	520 - 525
	B	525 - 530
	C	530 - 535
Blue	Full	459 - 471
	A	459 - 463
	B	463 - 467
	C	467 - 471

---

**Luminous Intensity Group at Tj=25°C**

<b>Color</b>	<b>Brightness Group</b>	<b>Luminous Intensity <small>Appx. 1.1</small> IV (mcd)</b>
Red	U3	650.0 ... 900.0
	V3	900.0 ... 1280.0
True Green	W2	1400.0 ... 1800.0
	X1	1800.0 ... 2240.0
	X2	2240.0 ... 2850.0
Blue	S2	224.0 ... 285.0
	T1	285.0 ... 355.0
	T2	355.0 ... 450.0

---

**Relative Luminous Intensity Vs Forward Current (Red)**

$I_v/I_v(20\text{mA}) = f(I_F); T_j = 25^\circ\text{C}$

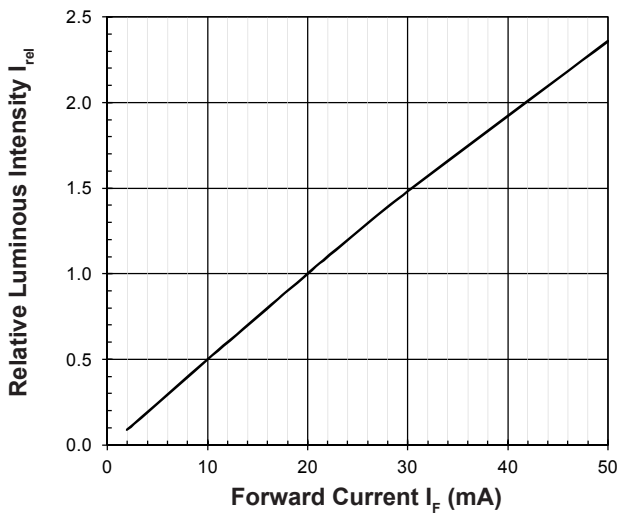

**Relative Luminous Intensity Vs Forward Current (Blue & True Green)**

$I_v/I_v(20\text{mA}) = f(I_F); T_j = 25^\circ\text{C}$

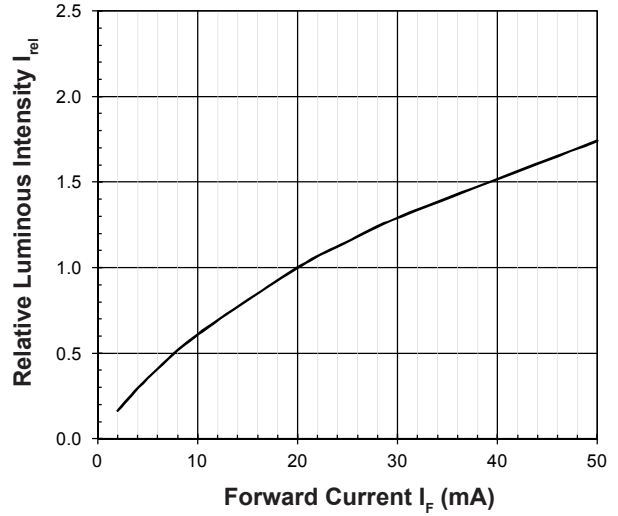

**Forward Current Vs Forward Voltage (Red)**

$I_F = f(V_F); T_j = 25^\circ\text{C}$

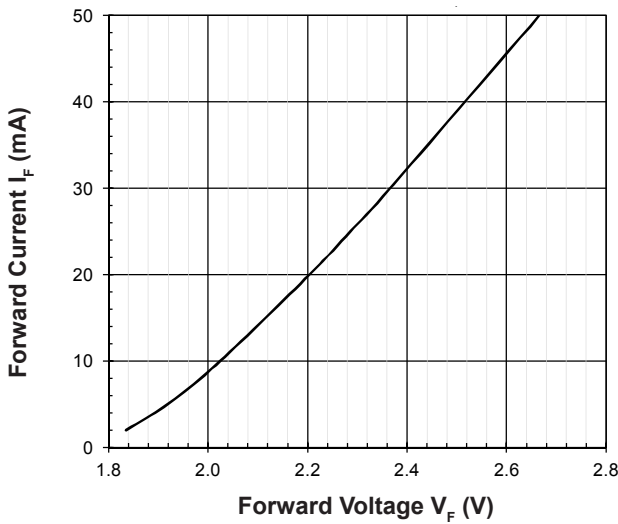

**Forward Current Vs Forward Voltage (Blue & True Green)**

$I_F = f(V_F); T_j = 25^\circ\text{C}$

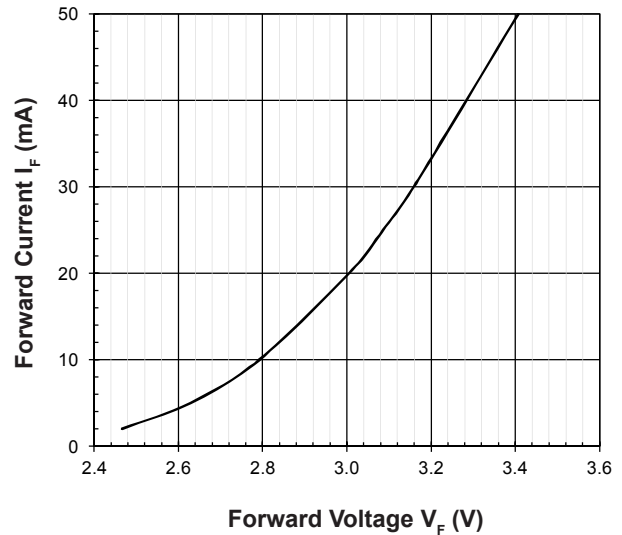

**Maximum Current Vs Temperature (Red)  $I_F = f(T)$**

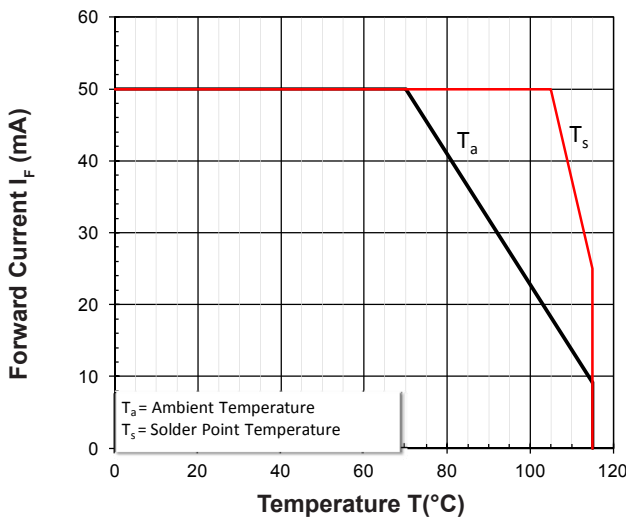

**Maximum Current Vs Temperature (Blue & True Green)  $I_F = f(T)$**

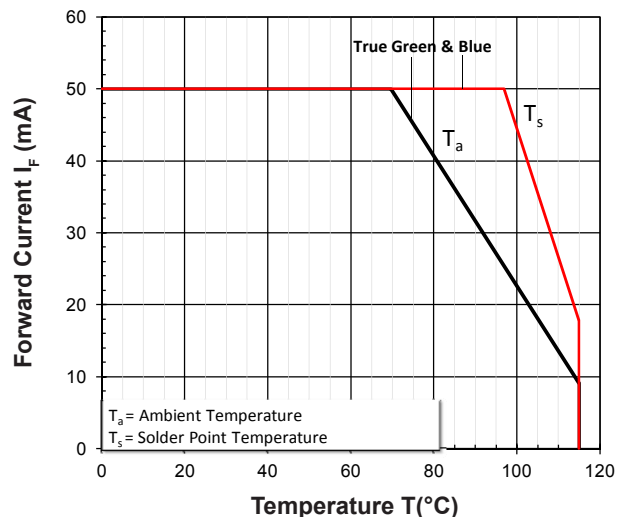

**Relative Spectral Emission**

$I_{rel} = f(\lambda); T_j = 25^\circ\text{C}; I_F = 20\text{mA}$

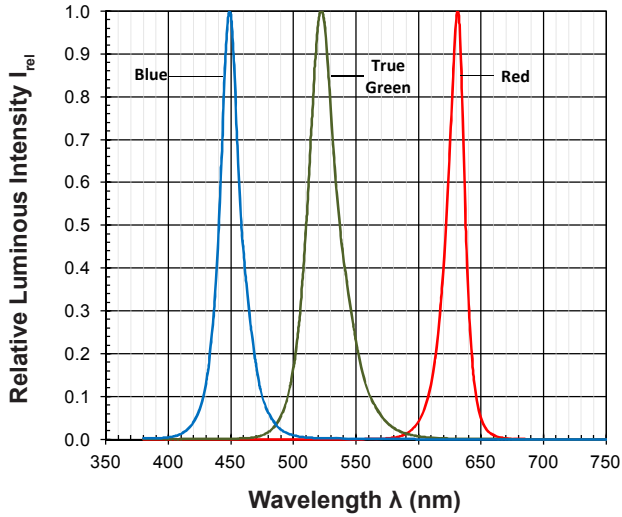

**Allowable Forward Current Vs Duty Ratio**

$(T_j = 25^\circ\text{C}; t_p \leq 10\mu\text{s})$

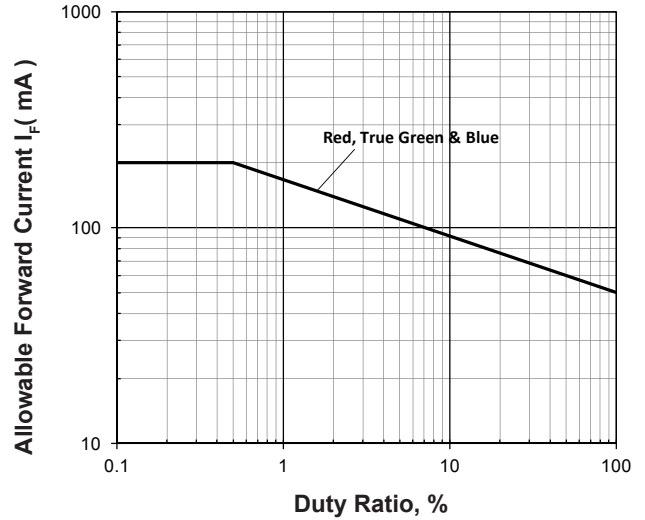

**Relative Wavelength Shift Vs Forward Current**

$\lambda_{dom} = f(I_F); T_j = 25^\circ\text{C}$

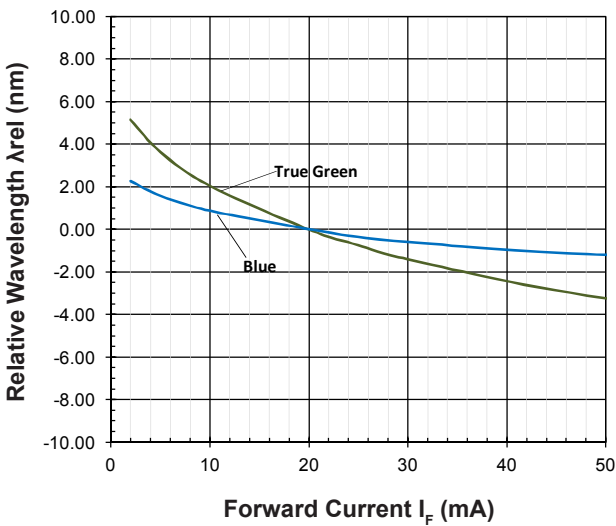

**Radiation Pattern**

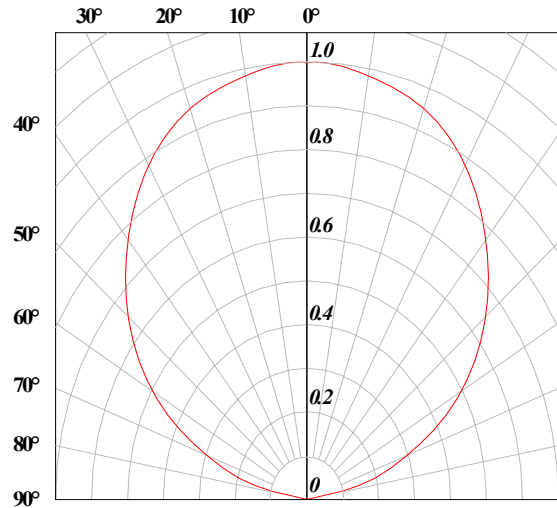

**Relative Forward Voltage Vs Junction Temperature**

$\Delta V_F = V_F - V_F(25^\circ\text{C}) = f(T_j); I_F = 20\text{mA}$

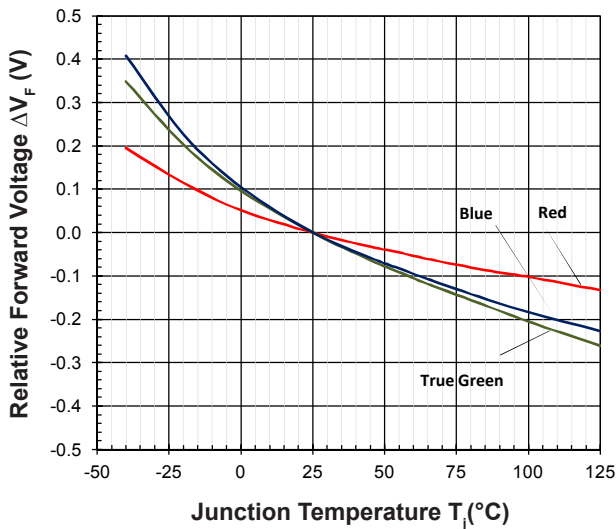

**Relative Luminous Intensity Vs Junction Temperature**

$I_V/I_V(25^\circ\text{C}) = f(T_j); I_F = 20\text{mA}$

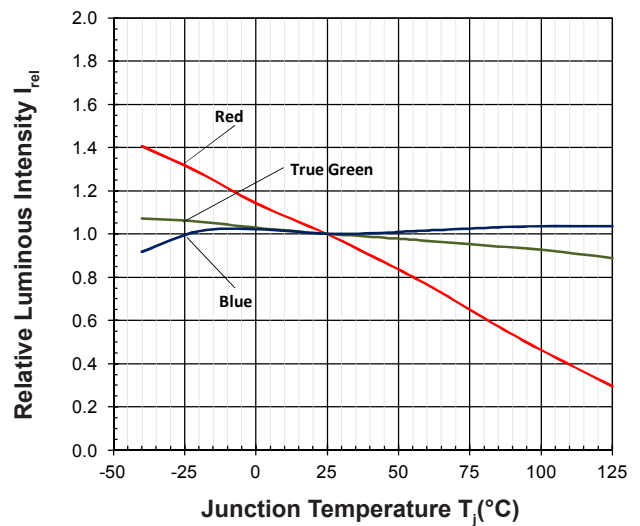

**Relative Wavelength Vs Junction Temperature**

$\Delta\lambda_{dom} = \lambda_{dom} - \lambda_{dom}(25^\circ\text{C}) = f(T_j); IF = 20\text{mA}$

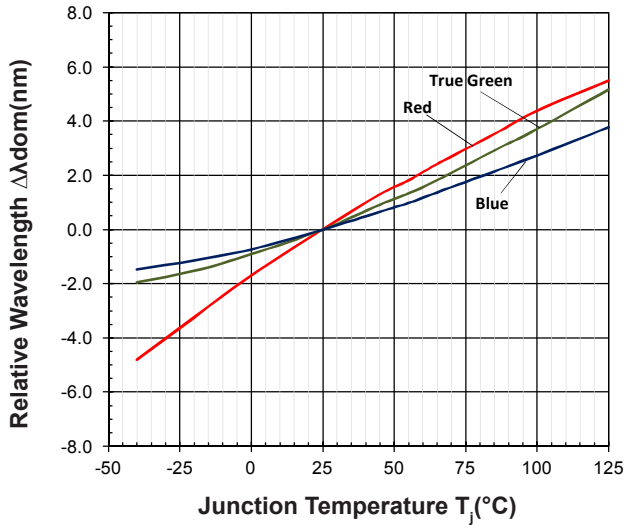

**Multi DomiLED : D6RTB-SKG Package Outlines**

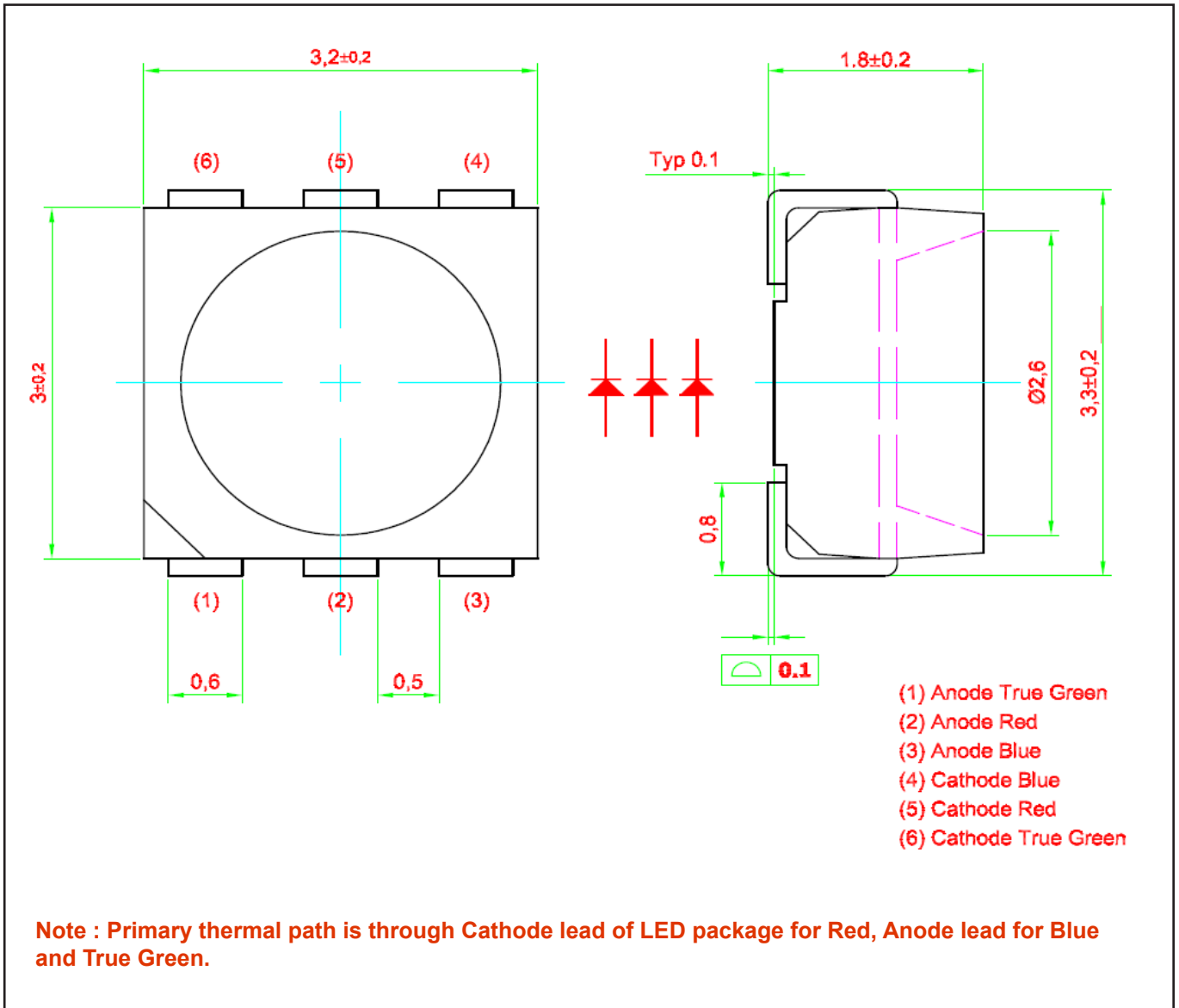

**Materials**

Materials	
Lead Frame	Cu Alloy with NipdAu Plating
Housing	High temperature resistant plastic, PPA
Encapsulant	Silicone
Lead-finishing	NipdAu Plating

Note: Package is Pb-free.



### Recommended Solder Pad

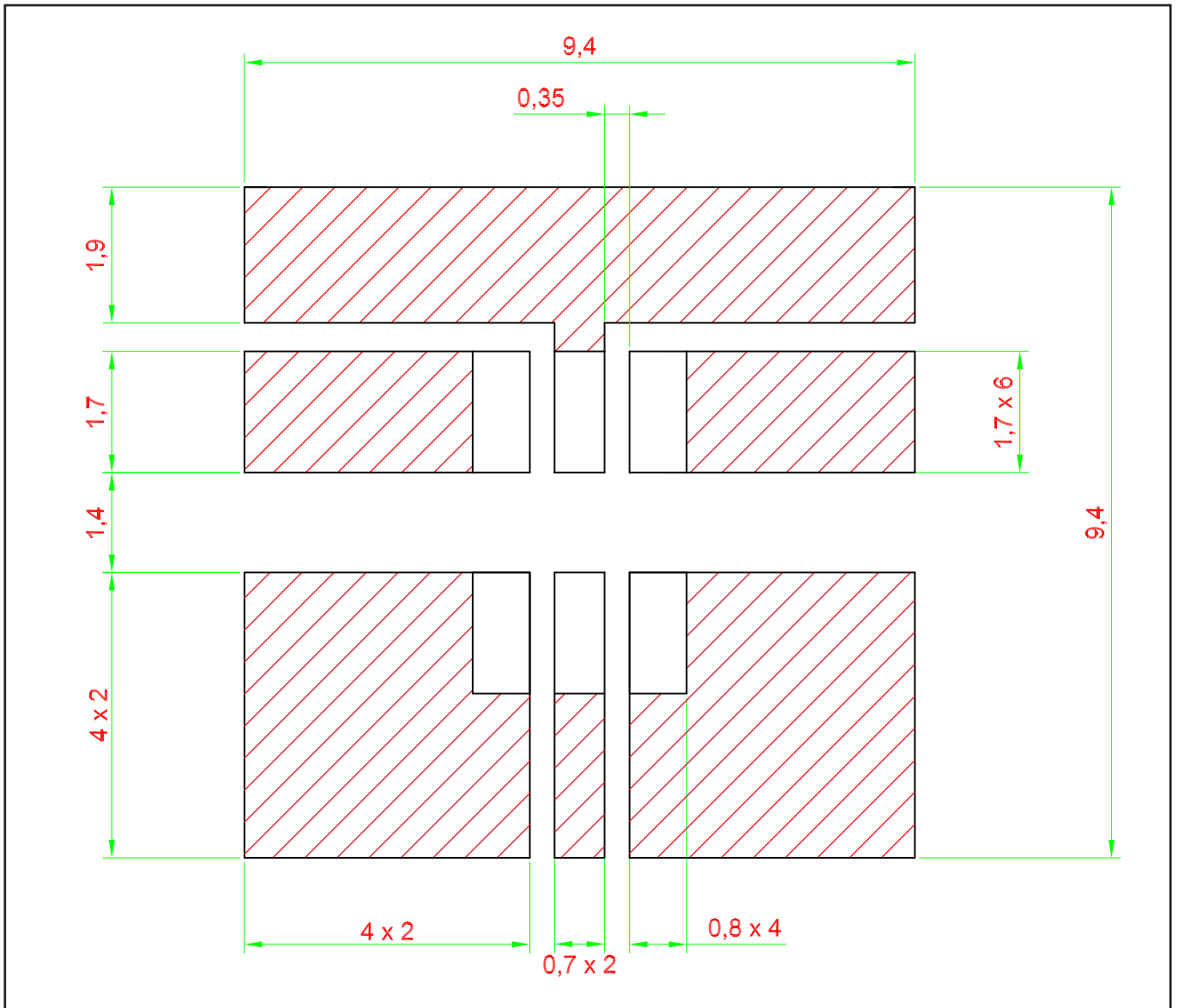

## Taping and orientation

- Reels come in quantity of 1000 units.
- Reel diameter is 180 mm.

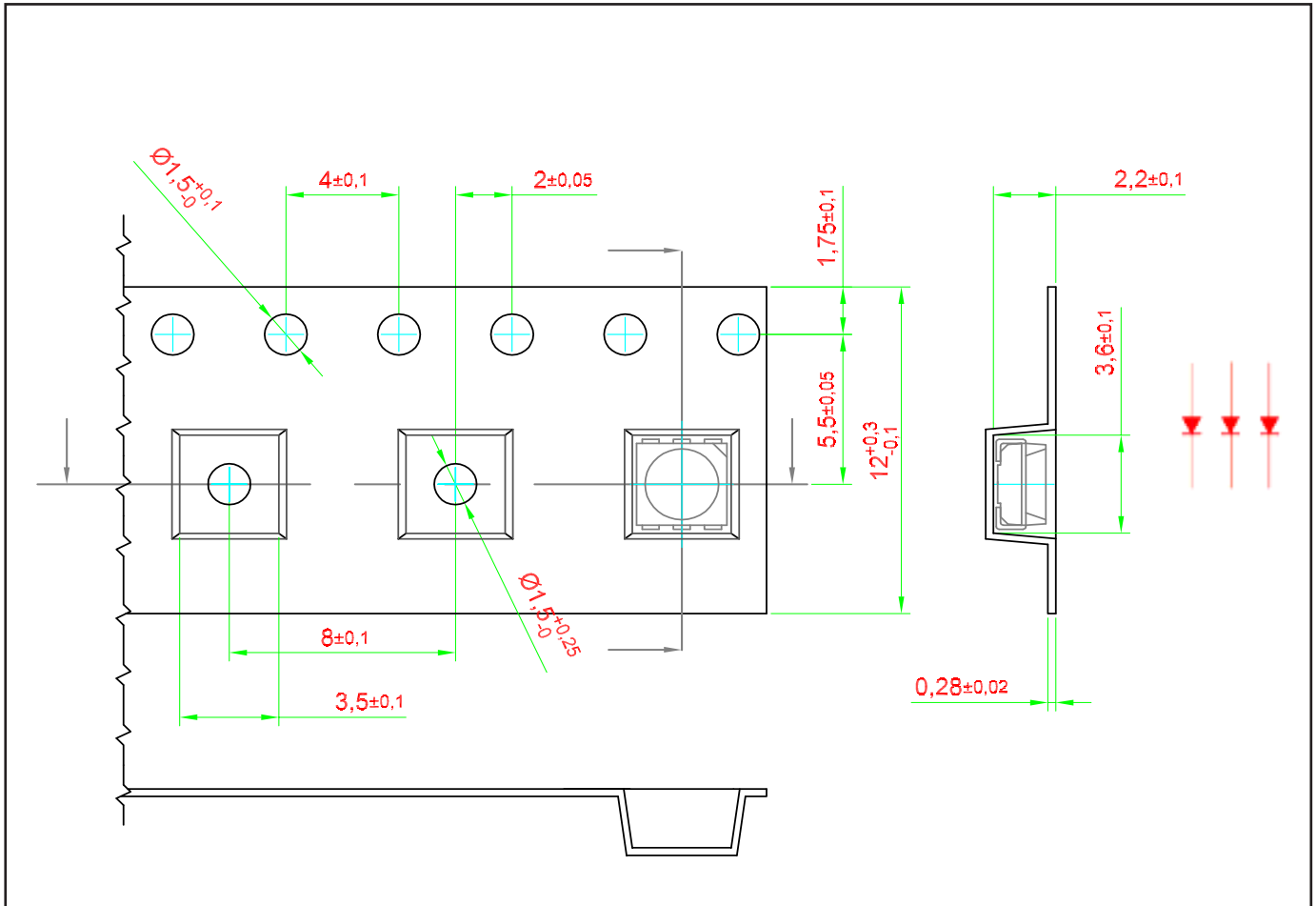

**Packaging Specification**

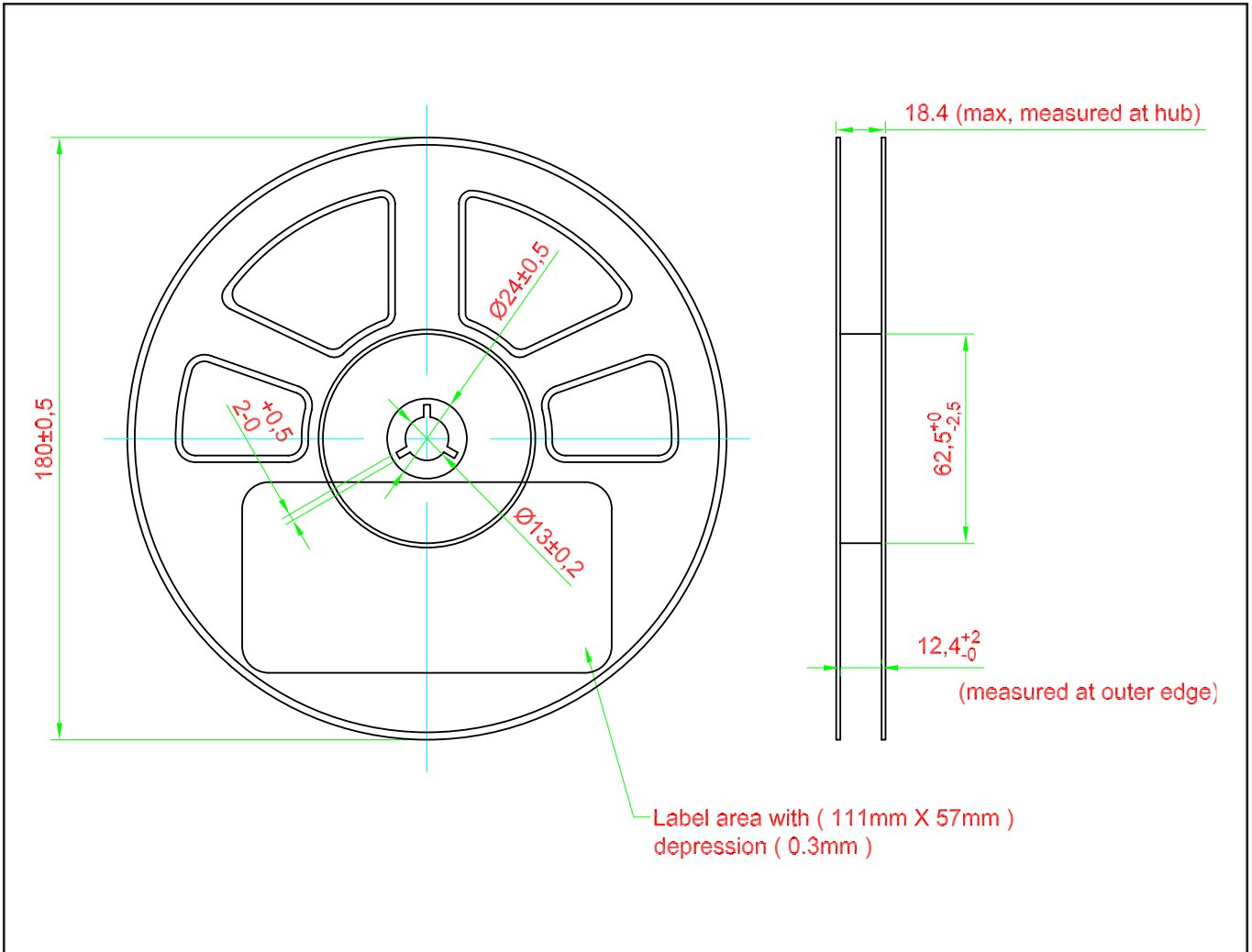

**Packaging Specification**

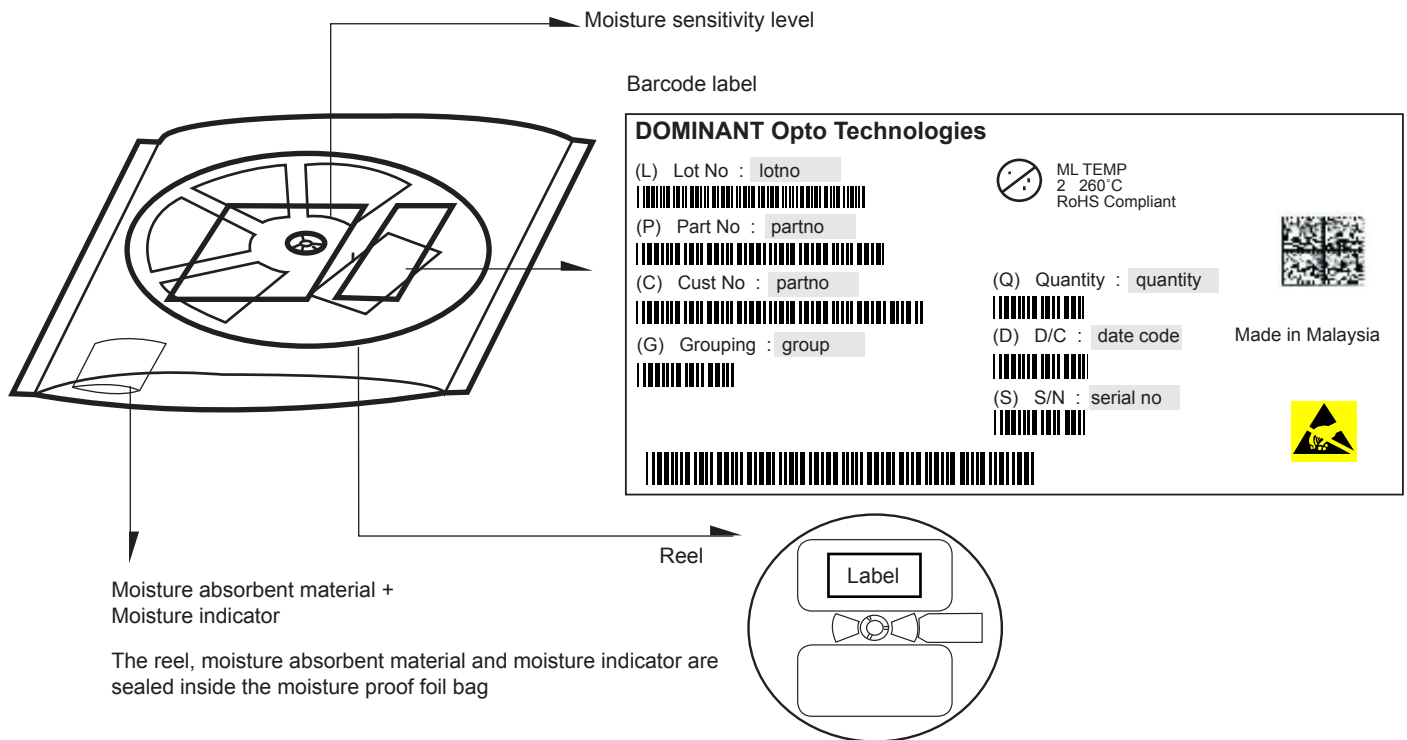

	Average 1pc Multi DomiLED	1 completed bag (1000pcs)
Weight (gram)	0.034	240 ± 10

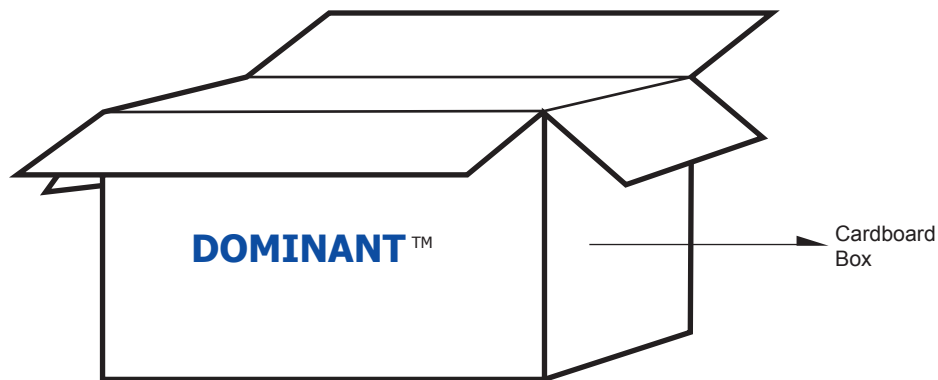

**For Multi DomiLED**

Cardboard Box Size	Dimensions (mm)	Empty Box Weight (kg)	Reel / Box
Super Small	325 x 225 x 190	0.38	7 reels MAX
Small	325 x 225 x 280	0.54	11 reels MAX
Medium	570 x 440 x 230	1.46	48 reels MAX
Large	570 x 440 x 460	1.92	96 reels MAX

**Recommended Pb-free Soldering Profile**

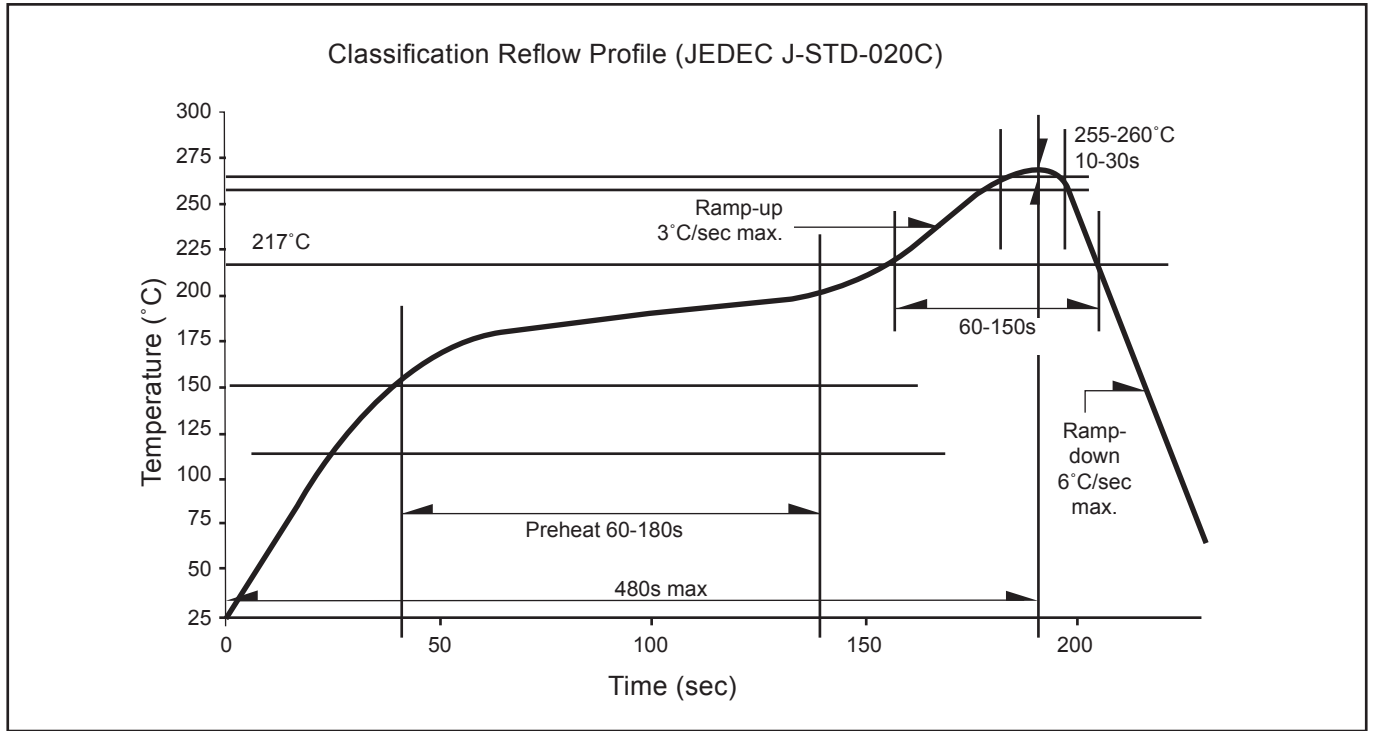

---

## Appendix

### 1) **Brightness:**

- 1.1 Luminous intensity is measured with an internal reproducibility of  $\pm 8 \%$  and an expanded uncertainty of  $\pm 11 \%$  (according to GUM with a coverage factor of  $k=3$ ).
- 1.2 Luminous flux is measured with an internal reproducibility of  $\pm 8 \%$  and an expanded uncertainty of  $\pm 11 \%$  (according to GUM with a coverage factor of  $k=3$ ).

### 2) **Color:**

- 2.1 Chromaticity coordinate groups are measured with an internal reproducibility of  $\pm 0.005$  and an expanded uncertainty of  $\pm 0.01$  (accordingly to GUM with a coverage factor of  $k=3$ ).
- 2.2 DOMINANT wavelength is measured with an internal reproducibility of  $\pm 0.5\text{nm}$  and an expanded uncertainty of  $\pm 1\text{nm}$  (accordingly to GUM with a coverage factor of  $k=3$ ).

### 3) **Voltage:**

- 3.1 Forward Voltage,  $V_f$  is measured with an internal reproducibility of  $\pm 0.05\text{V}$  and an expanded uncertainty of  $\pm 0.1\text{V}$  (accordingly to GUM with a coverage factor of  $k=3$ ).

**Revision History**

Page	Subjects	Date of Modification
-	Initial Release	22 May 2017
5, 6, 7	Update Graph	29 Sep 2017

**NOTE**

All the information contained in this document is considered to be reliable at the time of publishing. However, DOMINANT Opto Technologies does not assume any liability arising out of the application or use of any product described herein.

DOMINANT Opto Technologies reserves the right to make changes to any products in order to improve reliability, function or design.

DOMINANT Opto Technologies products are not authorized for use as critical components in life support devices or systems without the express written approval from the Managing Director of DOMINANT Opto Technologies.

## About Us

DOMINANT Opto Technologies is a dynamic company that is amongst the world's leading automotive LED manufacturers. With an extensive industry experience and relentless pursuit of innovation, DOMINANT's state-of-art manufacturing and development capabilities have become a trusted and reliable brand across the globe. More information about DOMINANT Opto Technologies, a ISO/TS 16949 and ISO 14001 certified company, can be found under <http://www.dominant-semi.com>.

### **Please contact us for more information:**

DOMINANT Opto Technologies Sdn. Bhd.  
Lot 6, Batu Berendam, FTZ Phase III, 75350 Melaka, Malaysia  
Tel: (606) 283 3566 Fax: (606) 283 0566  
E-mail: [sales@dominant-semi.com](mailto:sales@dominant-semi.com)