



D965SS / D965ASS

NPN EPITAXIAL SILICON TRANSISTOR

LOW VOLTAGE HIGH CURRENT NPN TRANSISTOR

■ FEATURES

- * Collector current up to 5A
- * D965SS : Collector-Emitter voltage up to 20 V
- * D965ASS : Collector-Emitter voltage up to 30 V

■ APPLICATIONS

- * Audio amplifier
- * Flash unit of camera
- * Switching circuit

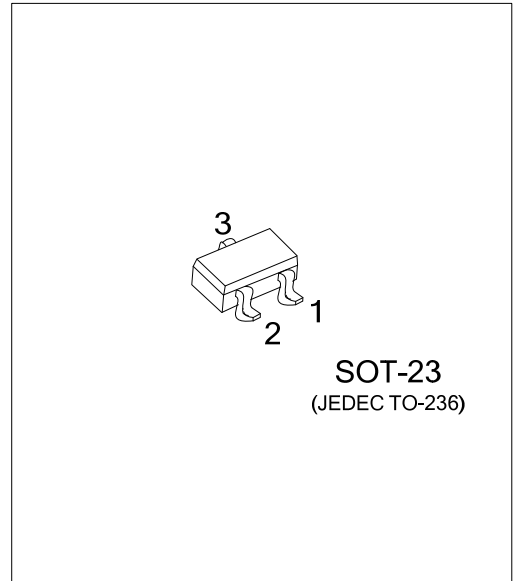

■ ORDERING INFORMATION

Order Number	Package	Pin Assignment			Packing
		1	2	3	
D965SSG-x-AE3-R	SOT-23	E	B	C	Tape Reel
D965ASSG-x-AE3-R	SOT-23	E	B	C	Tape Reel

<p>D965SSG-x-AE3-R</p> <p>(1) Packing Type (2) Package Type (3) Rank (4) Green Package</p>	<p>(1) R: Tape Reel (2) AE3: SOT-23 (3) x: refer to Classification of h_{FE2} (4) G: Halogen Free and Lead Free</p>
--	--

■ MARKING

UTC D965SS	UTC D965ASS

D965SS / D965ASS

NPN EPITAXIAL SILICON TRANSISTOR

■ ABSOLUTE MAXIMUM RATING

PARAMETER	SYMBOL	RATINGS	UNIT
Collector-Base voltage	V_{CBO}	40	V
Collector-Emitter Voltage	D965SS	20	V
	D965ASS	30	
Emitter-Base Voltage	V_{EBO}	7	V
Collector dissipation($T_a=25^\circ\text{C}$)	P_c	750	mW
Collector current	I_c	5	A
Junction Temperature	T_J	150	$^\circ\text{C}$
Storage Temperature	T_{STG}	-65 ~ +150	$^\circ\text{C}$

■ ELECTRICAL CHARACTERISTICS ($T_A=25^\circ\text{C}$, unless otherwise specified)

PARAMETER	SYMBOL	TEST CONDITIONS	MIN	TYP	MAX	UNIT
Collector-base breakdown voltage	BV_{CBO}	$I_C=100\mu\text{A}, I_E=0$	40			V
Collector-emitter breakdown voltage	D965SS	$I_C=1\text{mA}, I_B=0$	20			V
	D965ASS		30			V
Emitter-base breakdown voltage	BV_{EBO}	$I_C=0, I_E=10\mu\text{A}$	7			V
Collector cut-off current	I_{CBO}	$V_{CB}=10\text{V}, I_E=0$			100	nA
Emitter cut-off current	I_{EBO}	$V_{EB}=7\text{V}, I_C=0$			100	nA
DC current gain	h_{FE1}	$V_{CE}=2\text{V}, I_C=1\text{mA}$		200		
	h_{FE2}	$V_{CE}=2\text{V}, I_C=0.5\text{A}$	230		800	
	h_{FE3}	$V_{CE}=2\text{V}, I_C=2\text{A}$	150			
Collector-emitter saturation voltage	$V_{CE(SAT)}$	$I_C=3\text{A}, I_B=0.1\text{A}$			1	V
Current gain bandwidth product	f_T	$V_{CE}=6\text{V}, I_C=50\text{mA}$		150		MHz
Output capacitance	C_{ob}	$V_{CB}=20\text{V}, I_E=0, f=1\text{MHz}$			50	pF

■ CLASSIFICATION OF h_{FE2}

RANK	Q	R	S
RANGE	230~380	340~600	560~800

■ TYPICAL CHARACTERISTICS

Fig.1 Static characteristics

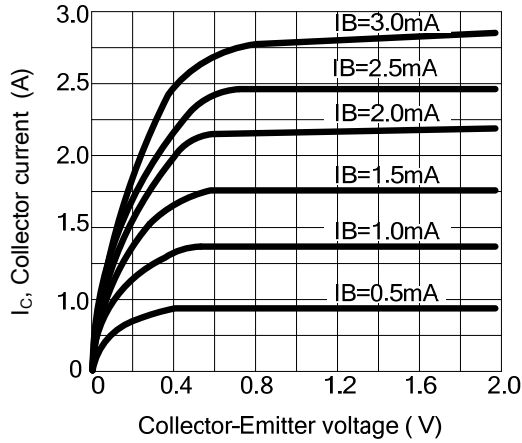

Fig.2 DC current Gain

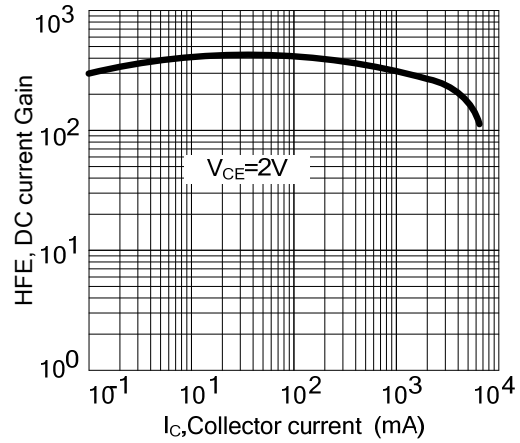

Fig.3 Base-Emitter on Voltage

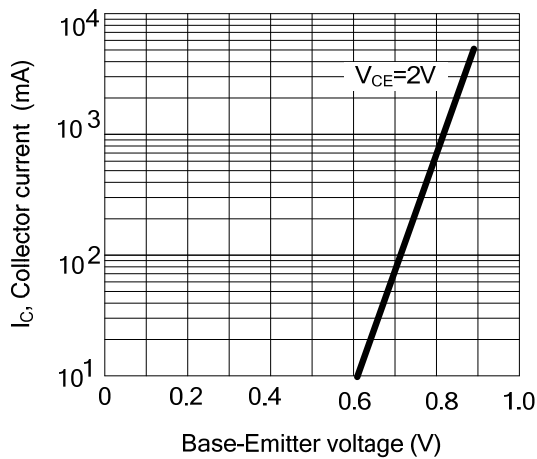

Fig.4 Saturation voltage

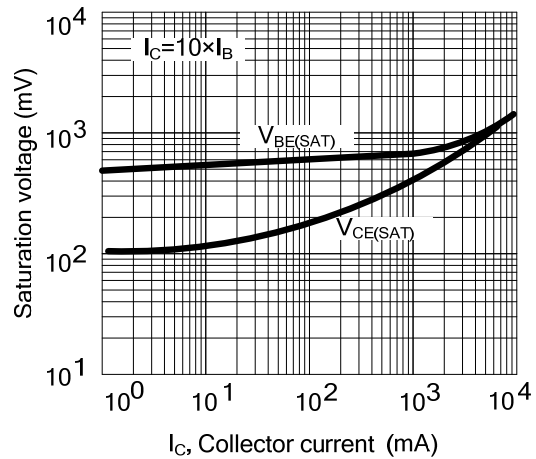

Fig.5 Current gain-bandwidth product

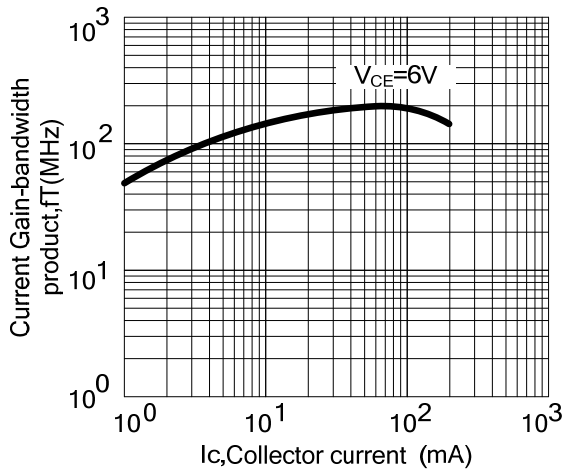
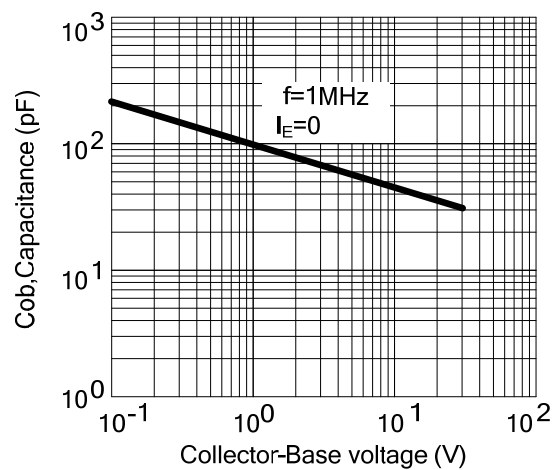

Fig.6 Collector output Capacitance



UTC assumes no responsibility for equipment failures that result from using products at values that exceed, even momentarily, rated values (such as maximum ratings, operating condition ranges, or other parameters) listed in products specifications of any and all UTC products described or contained herein. UTC products are not designed for use in life support appliances, devices or systems where malfunction of these products can be reasonably expected to result in personal injury. Reproduction in whole or in part is prohibited without the prior written consent of the copyright owner. The information presented in this document does not form part of any quotation or contract, is believed to be accurate and reliable and may be changed without notice.