



## 2SD965/A

## NPN SILICON TRANSISTOR

### LOW VOLTAGE HIGH CURRENT TRANSISTOR

#### FEATURES

- \* Collector current up to 5A
- \* UTC **2SD965**: Collector-Emitter voltage up to 20 V
- \* UTC **2SD965A**: Collector-Emitter voltage up to 30 V

#### APPLICATIONS

- \* Audio amplifier
- \* Flash unit of camera
- \* Switching circuit

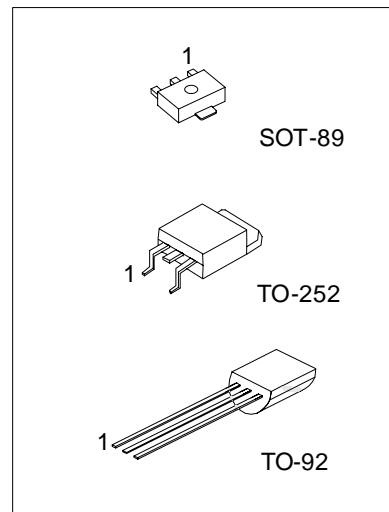

\*Pb-free plating product number:  
2SD965L/2SD965AL

#### ORDERING INFORMATION

Order Number		Package	Pin Assignment			Packing
Normal	Lead Free Plating		1	2	3	
2SD965-x-AB3-R	2SD965L-x-AB3-R	SOT-89	B	C	E	Tape Reel
2SD965-x-T92-B	2SD965L-x-T92-B	TO-92	E	C	B	Tape Box
2SD965-x-T92-K	2SD965L-x-T92-K	TO-92	E	C	B	Bulk
2SD965-x-TN3-R	2SD965L-x-TN3-R	TO-252	B	C	E	Tape Reel
2SD965-x-TN3-T	2SD965L-x-TN3-T	TO-252	B	C	E	Tube
2SD965A-x-AB3-R	2SD965AL-x-AB3-R	SOT-89	B	C	E	Tape Reel
2SD965A-x-T92-B	2SD965AL-x-T92-B	TO-92	E	C	B	Tape Box
2SD965A-x-T92-K	2SD965AL-x-T92-K	TO-92	E	C	B	Bulk
2SD965A-x-TN3-R	2SD965AL-x-TN3-R	TO-252	B	C	E	Tape Reel
2SD965A-x-TN3-T	2SD965AL-x-TN3-T	TO-252	B	C	E	Tube

<p>2SD965L-x-AB3-R</p>	<p>(1) B: Tape Box, K: Bulk, R: Tape Reel, T: Tube</p> <p>(2) AB3: SOT-89, T92: TO-92, TN3: TO-252</p> <p>(3) x: refer to Classification of <math>h_{FE2}</math></p> <p>(4) L: Lead Free Plating, Blank: Pb/Sn</p>
------------------------	--

■ ABSOLUTE MAXIMUM RATING (Ta=25 )

PARAMETER		SYMBOL	RATINGS	UNIT
Collector-Base Voltage		$V_{CBO}$	40	V
Collector-Emitter Voltage	2SD965	$V_{CEO}$	20	V
	2SD965A		30	V
Emitter-Base Voltage		$V_{EBO}$	7	V
Collector Dissipation	SOT-89	$P_C$	500	mW
	TO-92		750	mW
	TO-252		1	W
Collector Current		$I_C$	5	A
Junction Temperature		$T_J$	150	
Storage Temperature		$T_{STG}$	-65 ~ +150	

Note: Absolute maximum ratings are those values beyond which the device could be permanently damaged. Absolute maximum ratings are stress ratings only and functional device operation is not implied.

■ ELECTRICAL CHARACTERISTICS (Ta=25 , unless otherwise specified)

PARAMETER		SYMBOL	TEST CONDITIONS	MIN	TYP	MAX	UNIT
Collector-Base Breakdown Voltage		$BV_{CBO}$	$I_C=100\mu A, I_E=0$	40			V
Collector-Emitter Breakdown Voltage	2SD965	$BV_{CEO}$	$I_C=1mA, I_B=0$	20			V
	2SD965A			30			V
Emitter-Base Breakdown Voltage		$BV_{EBO}$	$I_E=10\mu A, I_C=0$	7			V
Collector Cut-off Current		$I_{CBO}$	$V_{CB}=10V, I_E=0$			100	nA
Emitter Cut-off Current		$I_{EBO}$	$V_{EB}=7V, I_C=0$			100	nA
DC Current Gain(note)		$h_{FE}$	$V_{CE}=2V, I_C=1mA$		200		
			$V_{CE}=2V, I_C=0.5A$	230		800	
			$V_{CE}=2V, I_C=2A$	150			
Collector-Emitter Saturation Voltage		$V_{CE(SAT)}$	$I_C=3A, I_B=0.1A$			1	V
Current Gain Bandwidth Product		$f_T$	$V_{CE}=6V, I_C=50mA$		150		MHz
Output Capacitance		$C_{ob}$	$V_{CB}=20V, I_E=0, f=1MHz$			50	pF

■ CLASSIFICATION OF  $h_{FE2}$

RANK	Q	R	S
RANGE	230-380	340-600	560-800

■ TYPICAL CHARACTERISTICS

Static Characteristics

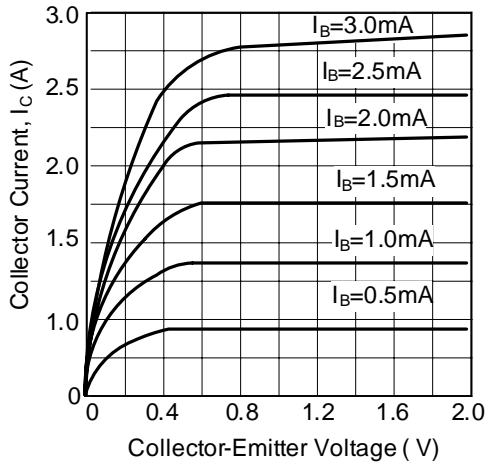

DC Current Gain

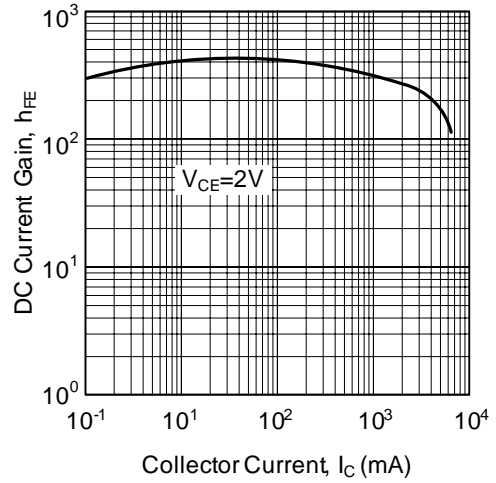

Base-Emitter on Voltage

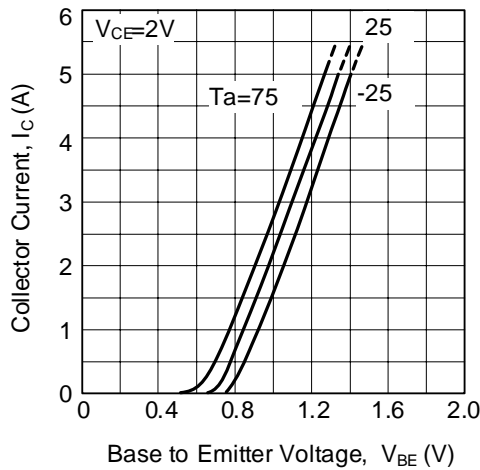

Saturation Voltage

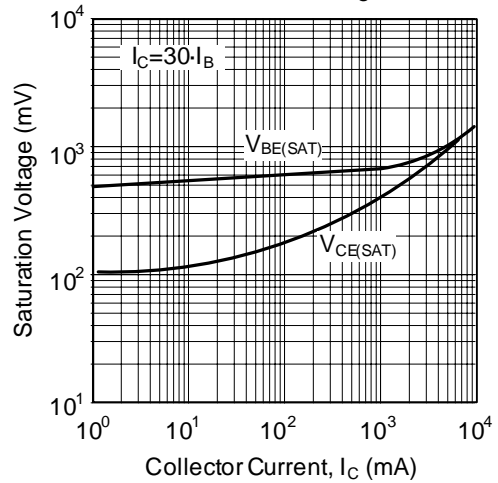

Current Gain-Bandwidth Product

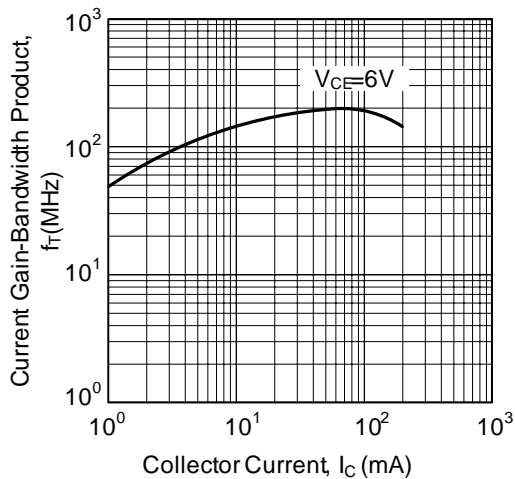

Collector Output Capacitance

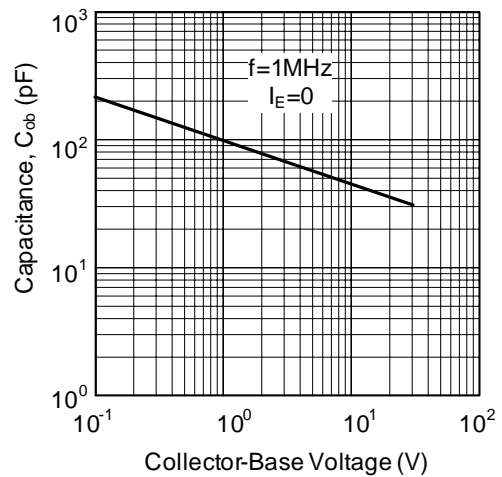

■ TYPICAL CHARACTERISTICS

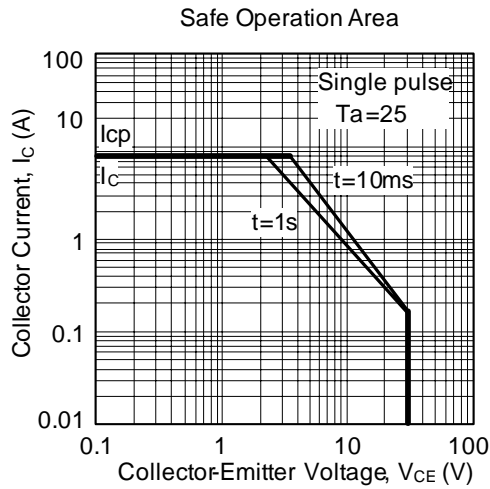

UTC assumes no responsibility for equipment failures that result from using products at values that exceed, even momentarily, rated values (such as maximum ratings, operating condition ranges, or other parameters) listed in products specifications of any and all UTC products described or contained herein. UTC products are not designed for use in life support appliances, devices or systems where malfunction of these products can be reasonably expected to result in personal injury. Reproduction in whole or in part is prohibited without the prior written consent of the copyright owner. The information presented in this document does not form part of any quotation or contract, is believed to be accurate and reliable and may be changed without notice.