

Switching diode

DA227 DAN202K / DAN202U / DAN222 DAP202K / DAP202U / DAP222

●Application

Ultra high speed switching



●Features

- 1) Four types of packaging are available.
- 2) High speed. ($t_{rr}=1.5\text{ns Typ.}$)
- 3) Suitable for high packing density layout.
- 4) High reliability.

●Construction

Silicon epitaxial planar

●Marking

DAN222 DAN202U DAN202K	
DAP222 DAP202U DAP202K	
DA227	

●External dimensions (Units : mm)

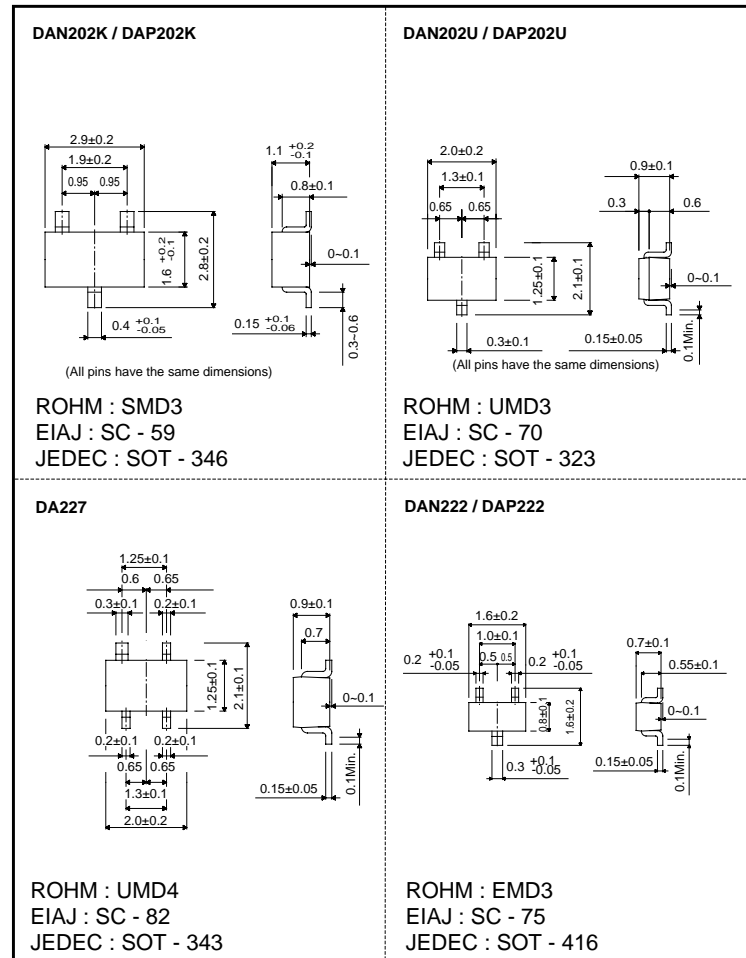

DA227/DAN202K/DAN202U/DAN222 DAP202K/DAP202U/DAP222

Diodes

●Circuits

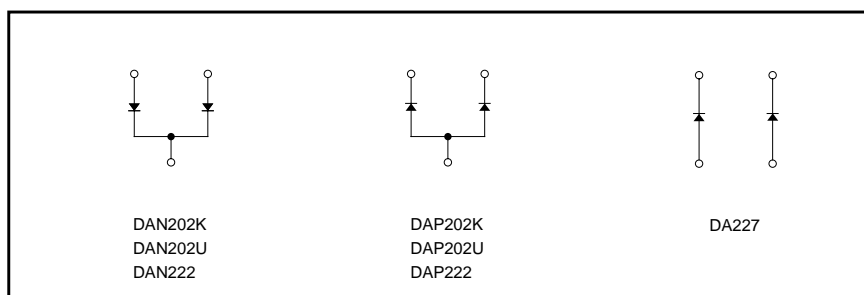

●Absolute maximum ratings (Ta=25°C)

Type	Peak reverse voltage V _{RM} (V)	DC reverse voltage V _R (V)	Peak forward current I _{FM} (mA)	Mean rectifying current I _O (mA)	Surge current (1μs) I _{surge} (A)	Power dissipation (TOTAL) Pd(mW)	Junction temperature T _j (°C)	Storage temperature T _{stg} (°C)	P / N Type
DAN202K	80	80	300	100	4	200	150	-55~+150	N
DAP202K	80	80	300	100	4	200	150	-55~+150	P
DAN202U	80	80	300	100	4	200	150	-55~+150	N
DAP202U	80	80	300	100	4	200	150	-55~+150	P
DAN222	80	80	300	100	4	150	150	-55~+150	N
DAP222	80	80	300	100	4	150	150	-55~+150	P
DA227	80	80	300	100	4	150	150	-55~+150	N

●Electrical characteristics (Ta=25°C)

Type	Forward voltage		Reverse current		Capacitance between terminals			Reverse recovery time		
	V _F (V) Max.	Cond.	I _R (μA) Max.	Cond.	C _T (pF) Max.	Cond.		t _{rr} (ns) Max.	Cond.	
		I _F (mA)		V _R (V)		V _R (V)	f (MHz)		V _R (V)	I _F (mA)
DAN202K	1.2	100	0.1	70	3.5	6	1	4	6	5
DAP202K	1.2	100	0.1	70	3.5	6	1	4	6	5
DAN202U	1.2	100	0.1	70	3.5	6	1	4	6	5
DAP202U	1.2	100	0.1	70	3.5	6	1	4	6	5
DAN222	1.2	100	0.1	70	3.5	6	1	4	6	5
DAP222	1.2	100	0.1	70	3.5	6	1	4	6	5
DA227	1.2	100	0.1	70	3.5	6	1	4	6	5

Diodes

●Electrical characteristic curves (Ta=25°C)

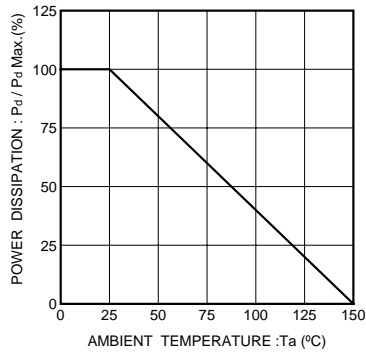

Fig.1 Power attenuation curve

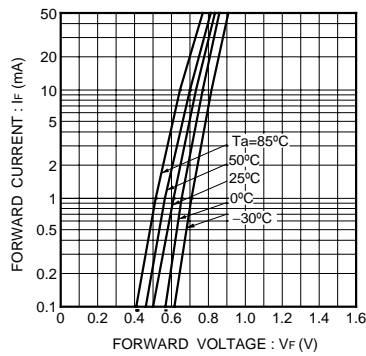

Fig.2 Forward characteristics (P Type)

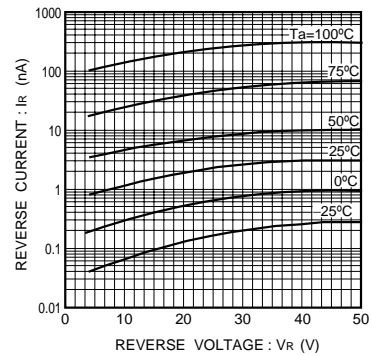

Fig.3 Reverse characteristics (P Type)

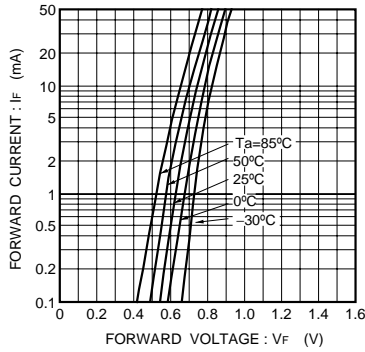

Fig.4 Forward characteristics (N Type)

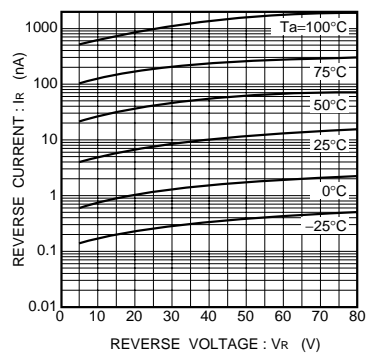

Fig.5 Reverse characteristics (N Type)

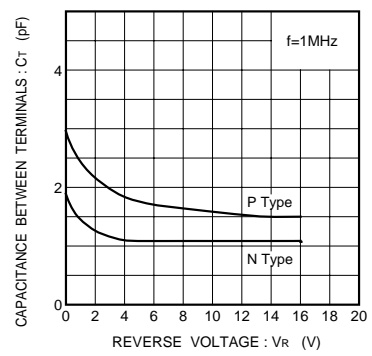

Fig.6 Capacitance between terminals characteristics

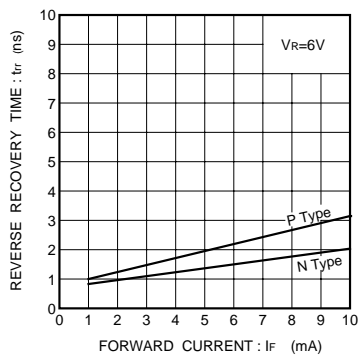

Fig.7 Reverse recovery time

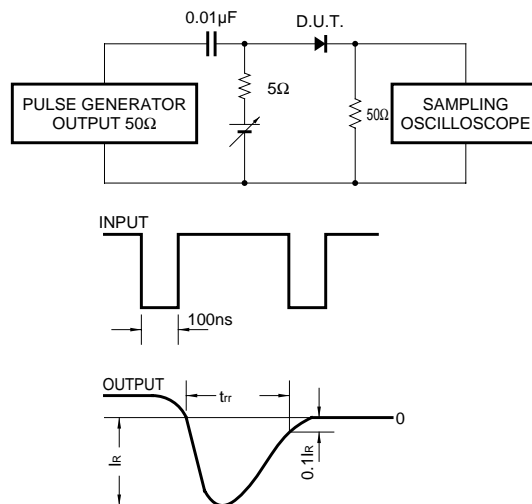

Fig.8 Reverse recovery time (t_{rr}) measurement circuit

This datasheet has been download from:

www.datasheetcatalog.com

Datasheets for electronics components.