

## DACxx6x-Q1 Automotive Dual 16-, 14-, 12-Bit, Low-Power, Buffered, Voltage-Output DACs With 2.5-V, 4-PPM/°C Internal Reference

### 1 Features

- Qualified for Automotive Applications
- AEC-Q100 Qualified with the Following Results:
  - Device Temperature Grade 1: –40°C to 125°C Ambient Operating Temperature Range
  - Device HBM ESD Classification Level 2
  - Device CDM ESD Classification Level C4B
- Relative Accuracy:
  - DAC756x (12-Bit): 0.3 LSB INL
  - DAC816x (14-Bit): 1 LSB INL
  - DAC856x (16-Bit): 4 LSB INL
- Glitch Impulse: 0.1 nV-s
- Bidirectional Reference: Input or 2.5-V Output
  - Output Disabled by Default
  - ±5-mV Initial Accuracy (Max)
  - 4-ppm/°C Temperature Drift (Typ)
  - 10-ppm/°C Temperature Drift (Max)
  - 20-mA Sink and Source Capability
- Power-On Reset to Zero Scale or Mid-Scale
- Low-Power: 4 mW (Typ, 5-V  $V_{DD}$ , Including Internal Reference Current)
- Wide Power-Supply Range: 2.7 V to 5.5 V
- 50-MHz SPI With Schmitt-Triggered Inputs
- LDAC and CLR Functions
- Output Buffer With Rail-to-Rail Operation
- Package: VSSOP-10

### 2 Applications

- Portable Instrumentation
- PLC Analog Output Module
- Closed-Loop Servo Control
- Voltage Controlled Oscillator Tuning
- Data Acquisition Systems
- Programmable Gain and Offset Adjustment

### 3 Description

The DAC756x-Q1, DAC816x-Q1, and DAC856x-Q1 (DACxx6x-Q1) devices are low-power, voltage-output, dual-channel, 12-, 14-, and 16-bit digital-to-analog converters (DACs), respectively. These devices include a 2.5-V, 4-ppm/°C internal reference, giving a full-scale output voltage range of 2.5 V or 5 V. The internal reference has an initial accuracy of ±5 mV and can source or sink up to 20 mA at the  $V_{REFIN}/V_{REFOUT}$  pin.

These devices are monotonic, providing excellent linearity and minimizing undesired code-to-code transient voltages (glitch). They use a versatile three-wire serial interface that operates at clock rates up to 50 MHz. The interface is compatible with standard SPI™, QSPI™, Microwire, and digital signal processor (DSP) interfaces. The DACxx62-Q1 devices incorporate a power-on-reset circuit that ensures the DAC output powers up and remains at zero scale until a valid code is written to the device, whereas the DACxx63-Q1 devices similarly power up at mid-scale. These devices contain a power-down feature that reduces current consumption to typically 550 nA at 5 V. The low power consumption, internal reference, and small footprint make these devices ideal for portable, battery-operated equipment.

The DACxx62-Q1 devices are drop-in and function-compatible with each device in this family, as are the DACxx63-Q1 devices. The entire family is available in a 10-pin VSSOP-10 (DGS) package.

#### Device Information<sup>(1)</sup>

PART NUMBER	PACKAGE	BODY SIZE (NOM)
DAC7562-Q1	VSSOP (10)	3.00 mm x 3.00 mm
DAC7563-Q1		
DAC8162-Q1		
DAC8163-Q1		
DAC8562-Q1		
DAC8563-Q1		

(1) For all available packages, see the orderable addendum at the end of the datasheet.

#### Simplified Block Diagram

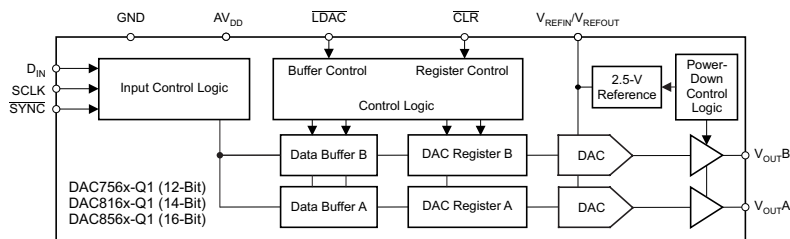

## Table of Contents

<b>1 Features</b> .....	<b>1</b>	8.4 Device Functional Modes.....	<b>30</b>
<b>2 Applications</b> .....	<b>1</b>	8.5 Programming.....	<b>34</b>
<b>3 Description</b> .....	<b>1</b>	<b>9 Application and Implementation</b> .....	<b>37</b>
<b>4 Revision History</b> .....	<b>2</b>	9.1 Application Information.....	<b>37</b>
<b>5 Device Comparison Table</b> .....	<b>3</b>	9.2 Typical Applications .....	<b>39</b>
<b>6 Pin Configuration and Functions</b> .....	<b>3</b>	9.3 System Examples .....	<b>43</b>
<b>7 Specifications</b> .....	<b>4</b>	<b>10 Power Supply Recommendations</b> .....	<b>44</b>
7.1 Absolute Maximum Ratings .....	<b>4</b>	<b>11 Layout</b> .....	<b>44</b>
7.2 ESD Ratings.....	<b>4</b>	11.1 Layout Guidelines .....	<b>44</b>
7.3 Recommended Operating Conditions.....	<b>4</b>	11.2 Layout Example .....	<b>45</b>
7.4 Thermal Information .....	<b>4</b>	<b>12 Device and Documentation Support</b> .....	<b>46</b>
7.5 Electrical Characteristics.....	<b>5</b>	12.1 Documentation Support .....	<b>46</b>
7.6 Timing Requirements.....	<b>7</b>	12.2 Related Links .....	<b>46</b>
7.7 Typical Characteristics .....	<b>8</b>	12.3 Community Resource.....	<b>46</b>
<b>8 Detailed Description</b> .....	<b>26</b>	12.4 Trademarks .....	<b>46</b>
8.1 Overview .....	<b>26</b>	12.5 Electrostatic Discharge Caution.....	<b>46</b>
8.2 Functional Block Diagram .....	<b>26</b>	12.6 Glossary .....	<b>46</b>
8.3 Feature Description.....	<b>26</b>	<b>13 Mechanical, Packaging, and Orderable Information</b> .....	<b>47</b>

## 4 Revision History

NOTE: Page numbers for previous revisions may differ from page numbers in the current version.

### Changes from Original (May 2013) to Revision A

Page

• Changed <i>Pin Configuration and Functions</i> section, <i>ESD Ratings</i> table, <i>Feature Description</i> section, <i>Device Functional Modes</i> , <i>Application and Implementation</i> section, <i>Power Supply Recommendations</i> section, <i>Layout</i> section, <i>Device and Documentation Support</i> section, and <i>Mechanical, Packaging, and Orderable Information</i> section .....	<b>1</b>
• Released the DAC8563-Q1, DAC8162-Q1, DAC8163-Q1, DAC7562-Q1, and DAC7563-Q1 devices.....	<b>1</b>
• Added the code-change total glitch amplitude parameter to the <i>Electrical Characteristics</i> table .....	<b>5</b>

## 5 Device Comparison Table

PART NUMBER	RESOLUTION	MAXIMUM RELATIVE ACCURACY (LSB)	MAXIMUM DIFFERENTIAL NONLINEARITY (LSB)	MAXIMUM REFERENCE DRIFT (ppm/°C)	RESET TO
DAC7562-Q1	12-bit	±0.75	±0.25	10	Zero
DAC7563-Q1					Mid-scale
DAC8162-Q1	14-bit	±3	±0.5	10	Zero
DAC8163-Q1					Mid-scale
DAC8562-Q1	16-bit	±12	±1	10	Zero
DAC8563-Q1					Mid-scale

## 6 Pin Configuration and Functions

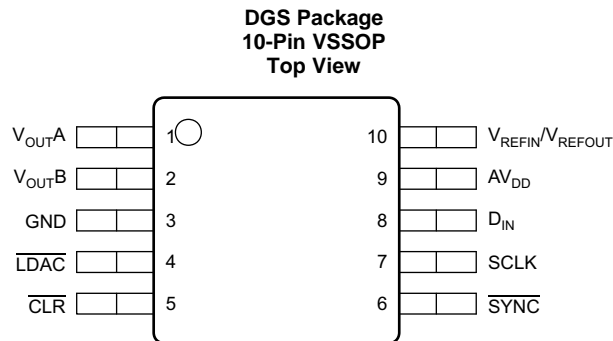

### Pin Functions

PIN		DESCRIPTION
NAME	NO.	
AV <sub>DD</sub>	9	Power-supply input, 2.7 V to 5.5 V
$\overline{\text{CLR}}$	5	Asynchronous clear input. The $\overline{\text{CLR}}$ input is falling-edge sensitive. When $\overline{\text{CLR}}$ is activated, zero scale (DACxx62-Q1) or mid-scale (DACxx63-Q1) is loaded to all input and DAC registers. This sets the DAC output voltages accordingly. The part exits clear code mode on the 24 <sup>th</sup> falling edge of the next write to the part. If $\overline{\text{CLR}}$ is activated during a write sequence, the write is aborted.
D <sub>IN</sub>	8	Serial data input. Data are clocked into the 24-bit input shift register on each falling edge of the serial clock input. Schmitt-trigger logic input
GND	3	Ground reference point for all circuitry on the device
$\overline{\text{LDAC}}$	4	In <i>synchronous</i> mode, data are updated with the falling edge of the 24 <sup>th</sup> SCLK cycle, which follows a falling edge of SYNC. For such <i>synchronous</i> updates, the $\overline{\text{LDAC}}$ pin is not required, and it must be connected to GND permanently or asserted and held low before sending commands to the device. In <i>asynchronous</i> mode, the $\overline{\text{LDAC}}$ pin is used as a negative edge-triggered timing signal for simultaneous DAC updates. Multiple single-channel commands can be written in order to set different channel buffers to desired values and then make a falling edge on $\overline{\text{LDAC}}$ pin to simultaneously update the DAC output registers.
SCLK	7	Serial clock input. Data can be transferred at rates up to 50 MHz. Schmitt-trigger logic input
$\overline{\text{SYNC}}$	6	Level-triggered control input (active-low). This input is the frame synchronization signal for the input data. When SYNC goes low, it enables the input shift register, and data are sampled on subsequent falling clock edges. The DAC output updates following the 24 <sup>th</sup> clock falling edge. If $\overline{\text{SYNC}}$ is taken high before the 23 <sup>rd</sup> clock edge, the rising edge of SYNC acts as an interrupt, and the write sequence is ignored by the DAC756x-Q1, DAC816x-Q1, DAC856x-Q1. Schmitt-trigger logic input
V <sub>OUTA</sub>	1	Analog output voltage from DAC-A
V <sub>OUTB</sub>	2	Analog output voltage from DAC-B
V <sub>REFIN</sub> /V <sub>REFOUT</sub>	10	Bidirectional voltage reference pin. If internal reference is used, 2.5-V output.

## 7 Specifications

### 7.1 Absolute Maximum Ratings

Over operating free-air temperature range (unless otherwise noted).<sup>(1)</sup>

	MIN	MAX	UNIT
$V_{DD}$ to GND	-0.3	6	V
$\overline{CLR}$ , $D_{IN}$ , $\overline{LDAC}$ , SCLK and $\overline{SYNC}$ input voltage to GND	-0.3	$V_{DD} + 0.3$	V
$V_{OUT[A, B]}$ to GND	-0.3	$V_{DD} + 0.3$	V
$V_{REFIN}/V_{REFOUT}$ to GND	-0.3	$V_{DD} + 0.3$	V
Operating temperature	-40	125	°C
Junction temperature, $T_{J\ max}$		150	°C
Storage temperature, $T_{stg}$	-65	150	°C

(1) Stresses beyond those listed under *Absolute Maximum Ratings* may cause permanent damage to the device. These are stress ratings only, and functional operation of the device at these or any other conditions beyond those indicated under *Recommended Operating Conditions* is not implied. Exposure to absolute-maximum-rated conditions for extended periods may affect device reliability.

### 7.2 ESD Ratings

		VALUE	UNIT	
$V_{(ESD)}$ Electrostatic discharge	Human-body model (HBM), per AEC Q100-002 <sup>(1)</sup>	±2000	V	
	Charged-device model (CDM), per AEC Q100-011	All pins		±500
		Corner pins (1, 5, 6, and 10)		±750

(1) AEC Q100-002 indicates that HBM stressing shall be in accordance with the ANSI/ESDA/JEDEC JS-001 specification.

### 7.3 Recommended Operating Conditions

over operating free-air temperature range (unless otherwise noted)

		MIN	NOM	MAX	UNIT
<b>POWER SUPPLY</b>					
Supply voltage	$V_{DD}$ to GND	2.7		5.5	V
<b>DIGITAL INPUTS</b>					
Digital input voltage	$\overline{CLR}$ , $D_{IN}$ , $\overline{LDAC}$ , SCLK and $\overline{SYNC}$	0		$V_{DD}$	V
<b>REFERENCE INPUT</b>					
$V_{REFIN}$ Reference input voltage		0		$V_{DD}$	V
<b>TEMPERATURE RANGE</b>					
$T_A$ Operating ambient temperature		-40		125	°C

### 7.4 Thermal Information

THERMAL METRIC <sup>(1)</sup>		DACxx6x-Q1	UNIT
		DGS (VSSOP)	
		10 PINS	
$R_{\theta JA}$	Junction-to-ambient thermal resistance	173.8	°C/W
$R_{\theta JC(top)}$	Junction-to-case (top) thermal resistance	48.5	°C/W
$R_{\theta JB}$	Junction-to-board thermal resistance	79.9	°C/W
$\Psi_{JT}$	Junction-to-top characterization parameter	1.7	°C/W
$\Psi_{JB}$	Junction-to-board characterization parameter	68.4	°C/W

(1) For more information about traditional and new thermal metrics, see the *Semiconductor and IC Package Thermal Metrics* application report, [SPRA953](#).

## 7.5 Electrical Characteristics

 At  $AV_{DD} = 2.7\text{ V to }5.5\text{ V}$  and  $T_A = -40^\circ\text{C to }125^\circ\text{C}$  (unless otherwise noted).

PARAMETER		TEST CONDITIONS	MIN	TYP	MAX	UNIT
<b>STATIC PERFORMANCE<sup>(1)</sup></b>						
DAC856x-Q1	Resolution		16			Bits
	Relative accuracy	Using line passing through codes 512 and 65,024		±4	±12	LSB
	Differential nonlinearity	16-bit monotonic		±0.2	±1	LSB
DAC816x-Q1	Resolution		14			Bits
	Relative accuracy	Using line passing through codes 128 and 16,256		±1	±3	LSB
	Differential nonlinearity	14-bit monotonic		±0.1	±0.5	LSB
DAC756x-Q1	Resolution		12			Bits
	Relative accuracy	Using line passing through codes 32 and 4,064		±0.3	±0.75	LSB
	Differential nonlinearity	12-bit monotonic		±0.05	±0.25	LSB
Offset error		Extrapolated from two-point line <sup>(1)</sup> , unloaded		±1	±4	mV
Offset error drift				±2		$\mu\text{V}/^\circ\text{C}$
Full-scale error		DAC register loaded with all 1s		±0.03	±0.2	% FSR
Zero-code error		DAC register loaded with all 0s		1	4	mV
Zero-code error drift				±2		$\mu\text{V}/^\circ\text{C}$
Gain error		Extrapolated from two-point line <sup>(1)</sup> , unloaded		±0.01	±0.15	% FSR
Gain temperature coefficient				±1		ppm FSR/ $^\circ\text{C}$
<b>OUTPUT CHARACTERISTICS<sup>(2)</sup></b>						
Output voltage range			0		$AV_{DD}$	V
Output voltage settling time <sup>(3)</sup>	DACs unloaded			7		$\mu\text{s}$
	$R_L = 1\text{ M}\Omega$			10		
Slew rate		Measured between 20% - 80% of a full-scale transition		0.75		V/ $\mu\text{s}$
Capacitive load stability	$R_L = \infty$			1		nF
	$R_L = 2\text{ k}\Omega$			3		
Code-change glitch impulse		1-LSB change around major carry		0.1		nV-s
Digital feedthrough		SCLK toggling, $\overline{\text{SYNC}}$ high		0.1		nV-s
Power-on glitch impulse		$R_L = 2\text{ k}\Omega$ , $C_L = 470\text{ pF}$ , $AV_{DD} = 5.5\text{ V}$		40		mV
Code-change total glitch amplitude		1-LSB change around major carry. Includes glitch impulse and digital feedthrough. $R_L = 2\text{ k}\Omega$ , $C_L = 470\text{ pF}$ , $AV_{DD} = 5.5\text{ V}$		3		mV
Channel-to-channel DC crosstalk	Full-scale swing on adjacent channel, External reference			5		$\mu\text{V}$
	Full-scale swing on adjacent channel, Internal reference			15		
DC output impedance		At mid-scale input		5		$\Omega$
Short-circuit current		DAC outputs at full-scale, DAC outputs shorted to GND		40		mA
Power-up time, including settling time		Coming out of power-down mode		50		$\mu\text{s}$
<b>AC PERFORMANCE<sup>(2)</sup></b>						
DAC output noise density		$T_A = 25^\circ\text{C}$ , at mid-scale input, $f_{OUT} = 1\text{ kHz}$		90		$\text{nV}/\sqrt{\text{Hz}}$
DAC output noise		$T_A = 25^\circ\text{C}$ , at mid-scale input, 0.1 Hz to 10 Hz		2.6		$\mu\text{V}_{PP}$

(1) 16-bit: codes 512 and 65,024; 14-bit: codes 128 and 16,256; 12-bit: codes 32 and 4,064

(2) Specified by design or characterization

 (3) Transition time between  $\frac{1}{4}$  scale and  $\frac{3}{4}$  scale including settling to within  $\pm 0.024\%$  FSR

## Electrical Characteristics (continued)

At  $V_{DD} = 2.7\text{ V to }5.5\text{ V}$  and  $T_A = -40^\circ\text{C to }125^\circ\text{C}$  (unless otherwise noted).

PARAMETER		TEST CONDITIONS	MIN	TYP	MAX	UNIT
<b>LOGIC INPUTS<sup>(2)</sup></b>						
Input pin Leakage current			-1	±0.1	1	µA
Logic input LOW voltage $V_{INL}$			0		0.8	V
Logic input HIGH voltage $V_{INH}$			$0.7 \times V_{DD}$		$V_{DD}$	V
Pin capacitance					3	pF
<b>REFERENCE</b>						
External reference current		External $V_{REF} = 2.5\text{ V}$ (when internal reference is disabled), all channels active using gain = 1		15		µA
Reference input impedance		Internal reference disabled, gain = 1		170		kΩ
		Internal reference disabled, gain = 2		85		
<b>REFERENCE OUTPUT</b>						
Output voltage		$T_A = 25^\circ\text{C}$	2.495	2.5	2.505	V
Initial accuracy		$T_A = 25^\circ\text{C}$	-5	±0.1	5	mV
Output voltage temperature drift				4	10	ppm/°C
Output voltage noise		$f = 0.1\text{ Hz to }10\text{ Hz}$		12		µV <sub>PP</sub>
Output voltage noise density (high-frequency noise)		$T_A = 25^\circ\text{C}$ , $f = 1\text{ kHz}$ , $C_L = 0\text{ }\mu\text{F}$		250		nV/ $\sqrt{\text{Hz}}$
		$T_A = 25^\circ\text{C}$ , $f = 1\text{ MHz}$ , $C_L = 0\text{ }\mu\text{F}$		30		
		$T_A = 25^\circ\text{C}$ , $f = 1\text{ MHz}$ , $C_L = 4.7\text{ }\mu\text{F}$		10		
Load regulation, sourcing <sup>(4)</sup>		$T_A = 25^\circ\text{C}$		20		µV/mA
Load regulation, sinking <sup>(4)</sup>		$T_A = 25^\circ\text{C}$		185		µV/mA
Output current load capability <sup>(2)</sup>				±20		mA
Line regulation		$T_A = 25^\circ\text{C}$		50		µV/V
Long-term stability and drift (aging) <sup>(4)</sup>		$T_A = 25^\circ\text{C}$ , time = 0 to 1900 hours		100		ppm
Thermal hysteresis <sup>(4)</sup>		First cycle		200		ppm
		Additional cycles		50		
<b>POWER REQUIREMENTS<sup>(5)</sup></b>						
$I_{DD}$	$V_{DD} = 3.6\text{ V to }5.5\text{ V}$	Normal mode, internal reference off		0.25	0.5	mA
		Normal mode, internal reference on		0.9	1.6	
		Power-down modes <sup>(6)</sup>		0.55	2	µA
		Power-down modes <sup>(7)</sup>		0.55	4	
	$V_{DD} = 2.7\text{ V to }3.6\text{ V}$	Normal mode, internal reference off		0.2	0.4	mA
		Normal mode, internal reference on		0.73	1.4	
		Power-down modes <sup>(6)</sup>		0.35	2	µA
		Power-down modes <sup>(7)</sup>		0.35	3	
Power dissipation	$V_{DD} = 3.6\text{ V to }5.5\text{ V}$	Normal mode, internal reference off		0.9	2.75	mW
		Normal mode, internal reference on		3.2	8.8	
		Power-down modes <sup>(6)</sup>		2	11	µW
		Power-down modes <sup>(7)</sup>		2	22	
	$V_{DD} = 2.7\text{ V to }3.6\text{ V}$	Normal mode, internal reference off		0.54	1.44	mW
		Normal mode, internal reference on		1.97	5	
		Power-down modes <sup>(6)</sup>		0.95	7.2	µW
		Power-down modes <sup>(7)</sup>		0.95	10.8	

(4) See the [Application Information](#) section of this data sheet.

(5) Input code = mid-scale, no load,  $V_{INH} = V_{DD}$ , and  $V_{INL} = \text{GND}$

(6) Temperature range  $-40^\circ\text{C to }105^\circ\text{C}$

(7) Temperature range  $-40^\circ\text{C to }125^\circ\text{C}$

## 7.6 Timing Requirements<sup>(1)(2)</sup>

At  $V_{DD} = 2.7\text{ V}$  to  $5.5\text{ V}$  and over  $-40^{\circ}\text{C}$  to  $125^{\circ}\text{C}$  (unless otherwise noted). See [Figure 1](#).

		MIN	NOM	MAX	UNIT
$f_{(\text{SCLK})}$	Serial clock frequency			50	MHz
$t_1$	SCLK falling edge to $\overline{\text{SYNC}}$ falling edge (for successful write operation)	10			ns
$t_2$	SCLK cycle time	20			ns
$t_3$	$\overline{\text{SYNC}}$ rising edge to 23 <sup>rd</sup> SCLK falling edge (for successful $\overline{\text{SYNC}}$ interrupt)	13			ns
$t_4$	Minimum $\overline{\text{SYNC}}$ HIGH time	80			ns
$t_5$	$\overline{\text{SYNC}}$ to SCLK falling edge setup time	13			ns
$t_6$	SCLK LOW time	8			ns
$t_7$	SCLK HIGH time	8			ns
$t_8$	SCLK falling edge to $\overline{\text{SYNC}}$ rising edge	10			ns
$t_9$	Data setup time	6			ns
$t_{10}$	Data hold time	5			ns
$t_{11}$	SCLK falling edge to $\overline{\text{LDAC}}$ falling edge for asynchronous LDAC update mode	5			ns
$t_{12}$	$\overline{\text{LDAC}}$ pulse duration, LOW time	10			ns
$t_{13}$	$\overline{\text{CLR}}$ pulse duration, LOW time	80			ns
$t_{14}$	$\overline{\text{CLR}}$ falling edge to start of $V_{OUT}$ transition		100		ns

- (1) All input signals are specified with  $t_R = t_F = 3\text{ ns}$  (10% to 90% of  $V_{DD}$ ) and timed from a voltage level of  $(V_{INL} + V_{INH}) / 2$ .  
 (2) See the *Serial Write Operation* timing diagram ([Figure 1](#)).

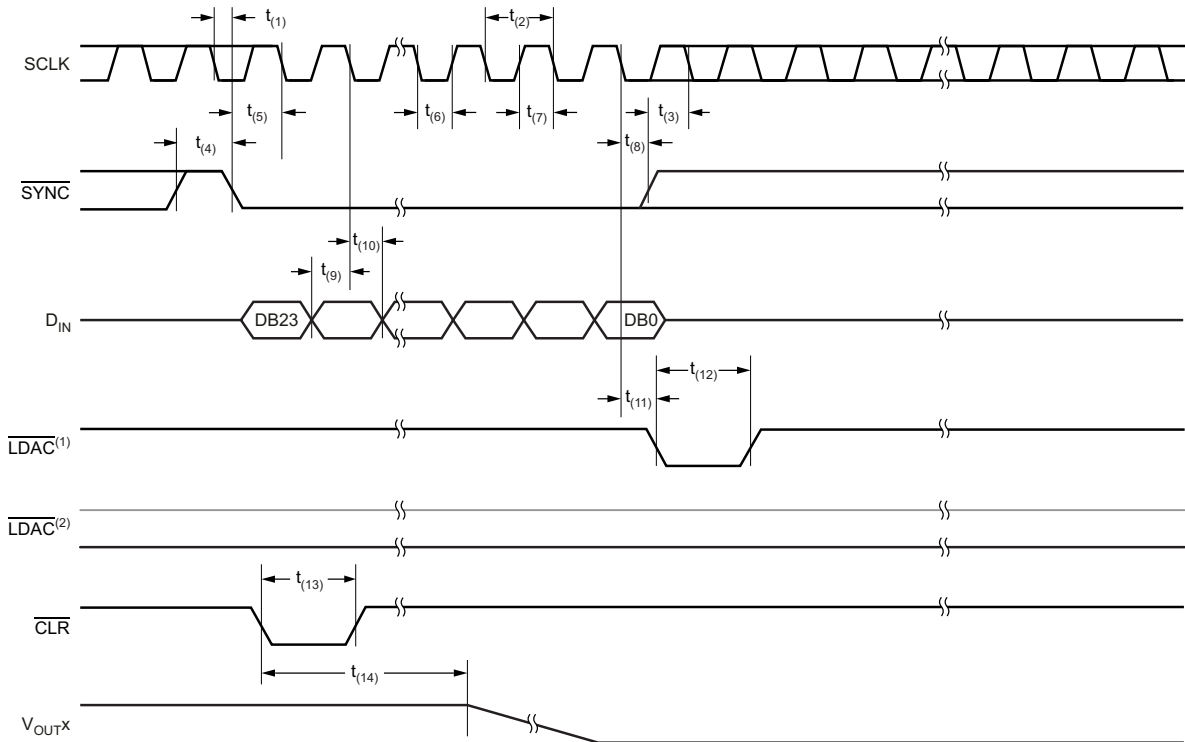

- (1) Asynchronous  $\overline{\text{LDAC}}$  update mode. For more information, see the [LDAC Functionality](#) section.  
 (2) Synchronous  $\overline{\text{LDAC}}$  update mode;  $\overline{\text{LDAC}}$  remains low. For more information, see the [LDAC Functionality](#) section.

**Figure 1. Serial Write Operation**



## 7.7 Typical Characteristics

### 7.7.1 Tables of Graphs

**Table 1. Typical Characteristics: Internal Reference Performance**

MEASUREMENT	POWER-SUPPLY VOLTAGE	FIGURE NUMBER
Internal Reference Voltage vs Temperature	5.5 V	<a href="#">Figure 2</a>
Internal Reference Voltage Temperature Drift Histogram		<a href="#">Figure 3</a>
Internal Reference Voltage vs Load Current		<a href="#">Figure 4</a>
Internal Reference Voltage vs Time		<a href="#">Figure 5</a>
Internal Reference Noise Density vs Frequency		<a href="#">Figure 6</a>
Internal Reference Voltage vs Supply Voltage	2.7 V – 5.5 V	<a href="#">Figure 7</a>

**Table 2. Typical Characteristics: DAC Static Performance**

MEASUREMENT	POWER-SUPPLY VOLTAGE	FIGURE NUMBER	
<b>FULL-SCALE, GAIN, OFFSET AND ZERO-CODE ERRORS</b>			
Full-Scale Error vs Temperature	5.5 V	<a href="#">Figure 16</a>	
Gain Error vs Temperature		<a href="#">Figure 17</a>	
Offset Error vs Temperature		<a href="#">Figure 18</a>	
Zero-Code Error vs Temperature		<a href="#">Figure 19</a>	
Full-Scale Error vs Temperature	2.7 V	<a href="#">Figure 63</a>	
Gain Error vs Temperature		<a href="#">Figure 64</a>	
Offset Error vs Temperature		<a href="#">Figure 65</a>	
Zero-Code Error vs Temperature		<a href="#">Figure 66</a>	
<b>LOAD REGULATION</b>			
DAC Output Voltage vs Load Current	5.5 V	<a href="#">Figure 30</a>	
	2.7 V	<a href="#">Figure 74</a>	
<b>DIFFERENTIAL NONLINEARITY ERROR</b>			
Differential Linearity Error vs Digital Input Code	T = –40°C	<a href="#">Figure 9</a>	
	T = 25°C	<a href="#">Figure 11</a>	
	T = 125°C	<a href="#">Figure 13</a>	
Differential Linearity Error vs Temperature	5.5 V	<a href="#">Figure 15</a>	
Differential Linearity Error vs Digital Input Code		T = –40°C	<a href="#">Figure 56</a>
		T = 25°C	<a href="#">Figure 58</a>
		T = 125°C	<a href="#">Figure 60</a>
Differential Linearity Error vs Temperature	2.7 V	<a href="#">Figure 62</a>	
<b>INTEGRAL NONLINEARITY ERROR (RELATIVE ACCURACY)</b>			
Linearity Error vs Digital Input Code	T = –40°C	<a href="#">Figure 8</a>	
	T = 25°C	<a href="#">Figure 10</a>	
	T = 125°C	<a href="#">Figure 12</a>	
Linearity Error vs Temperature	5.5 V	<a href="#">Figure 14</a>	
Linearity Error vs Digital Input Code		T = –40°C	<a href="#">Figure 55</a>
		T = 25°C	<a href="#">Figure 57</a>
		T = 125°C	<a href="#">Figure 59</a>
Linearity Error vs Temperature	2.7 V	<a href="#">Figure 61</a>	



**Table 2. Typical Characteristics: DAC Static Performance (continued)**

MEASUREMENT		POWER-SUPPLY VOLTAGE	FIGURE NUMBER	
<b>POWER-DOWN CURRENT</b>				
Power-Down Current vs Temperature		5.5 V	<a href="#">Figure 28</a>	
Power-Down Current vs Power-Supply Voltage		2.7 V – 5.5 V	<a href="#">Figure 29</a>	
Power-Down Current vs Temperature		2.7 V	<a href="#">Figure 73</a>	
<b>POWER-SUPPLY CURRENT</b>				
Power-Supply Current vs Temperature	External $V_{REF}$	5.5 V	<a href="#">Figure 20</a>	
	Internal $V_{REF}$		<a href="#">Figure 21</a>	
Power-Supply Current vs Digital Input Code	External $V_{REF}$		<a href="#">Figure 22</a>	
	Internal $V_{REF}$		<a href="#">Figure 23</a>	
Power-Supply Current Histogram	External $V_{REF}$		<a href="#">Figure 24</a>	
	Internal $V_{REF}$		<a href="#">Figure 25</a>	
Power-Supply Current vs Power-Supply Voltage	External $V_{REF}$		2.7 V – 5.5 V	<a href="#">Figure 26</a>
	Internal $V_{REF}$			<a href="#">Figure 27</a>
Power-Supply Current vs Temperature	External $V_{REF}$		3.6 V	<a href="#">Figure 49</a>
	Internal $V_{REF}$			<a href="#">Figure 50</a>
Power-Supply Current vs Digital Input Code	External $V_{REF}$	<a href="#">Figure 51</a>		
	Internal $V_{REF}$	<a href="#">Figure 52</a>		
Power-Supply Current Histogram	External $V_{REF}$	<a href="#">Figure 53</a>		
	Internal $V_{REF}$	<a href="#">Figure 54</a>		
Power-Supply Current vs Temperature	External $V_{REF}$	2.7 V		<a href="#">Figure 67</a>
	Internal $V_{REF}$			<a href="#">Figure 68</a>
Power-Supply Current vs Digital Input Code	External $V_{REF}$			<a href="#">Figure 69</a>
	Internal $V_{REF}$			<a href="#">Figure 70</a>
Power-Supply Current Histogram	External $V_{REF}$		<a href="#">Figure 71</a>	
	Internal $V_{REF}$		<a href="#">Figure 72</a>	

**Table 3. Typical Characteristics: DAC Dynamic Performance**

MEASUREMENT		POWER-SUPPLY VOLTAGE	FIGURE NUMBER
<b>CHANNEL-TO-CHANNEL CROSSTALK</b>			
Channel-to-Channel Crosstalk	5-V Rising Edge	5.5 V	<a href="#">Figure 43</a>
	5-V Falling Edge		<a href="#">Figure 44</a>
<b>CLOCK FEEDTHROUGH</b>			
Clock Feedthrough	500 kHz, Mid-Scale	5.5 V	<a href="#">Figure 48</a>
		2.7 V	<a href="#">Figure 87</a>
<b>GLITCH IMPULSE</b>			
Glitch Impulse, 1-LSB Step	Rising Edge, Code 7FFFh to 8000h	5.5 V	<a href="#">Figure 37</a>
	Falling Edge, Code 8000h to 7FFFh		<a href="#">Figure 38</a>
Glitch Impulse, 4-LSB Step	Rising Edge, Code 7FFCh to 8000h		<a href="#">Figure 39</a>
	Falling Edge, Code 8000h to 7FFCh		<a href="#">Figure 40</a>
Glitch Impulse, 16-LSB Step	Rising Edge, Code 7FF0h to 8000h		<a href="#">Figure 41</a>
	Falling Edge, Code 8000h to 7FF0h		<a href="#">Figure 42</a>

**Table 3. Typical Characteristics: DAC Dynamic Performance (continued)**

MEASUREMENT		POWER-SUPPLY VOLTAGE	FIGURE NUMBER
Glitch Impulse, 1-LSB Step	Rising Edge, Code 7FFFh to 8000h	2.7 V	<a href="#">Figure 79</a>
	Falling Edge, Code 8000h to 7FFFh		<a href="#">Figure 80</a>
Glitch Impulse, 4-LSB Step	Rising Edge, Code 7FFCh to 8000h		<a href="#">Figure 81</a>
	Falling Edge, Code 8000h to 7FFCh		<a href="#">Figure 82</a>
Glitch Impulse, 16-LSB Step	Rising Edge, Code 7FF0h to 8000h		<a href="#">Figure 83</a>
	Falling Edge, Code 8000h to 7FF0h		<a href="#">Figure 84</a>
<b>NOISE</b>			
DAC Output Noise Density vs Frequency	External $V_{REF}$	5.5 V	<a href="#">Figure 45</a>
	Internal $V_{REF}$		<a href="#">Figure 46</a>
DAC Output Noise 0.1 Hz to 10 Hz	External $V_{REF}$		<a href="#">Figure 47</a>
<b>POWER-ON GLITCH</b>			
Power-on Glitch	Reset to Zero Scale	5.5 V	<a href="#">Figure 35</a>
	Reset to Mid-Scale		<a href="#">Figure 36</a>
	Reset to Zero Scale	2.7 V	<a href="#">Figure 85</a>
	Reset to Mid-Scale		<a href="#">Figure 86</a>
<b>SETTLING TIME</b>			
Full-Scale Settling Time	Rising Edge, Code 0h to FFFFh	5.5 V	<a href="#">Figure 31</a>
	Falling Edge, Code FFFFh to 0h		<a href="#">Figure 32</a>
Half-Scale Settling Time	Rising Edge, Code 4000h to C000h		<a href="#">Figure 33</a>
	Falling Edge, Code C000h to 4000h		<a href="#">Figure 34</a>
Full-Scale Settling Time	Rising Edge, Code 0h to FFFFh	2.7 V	<a href="#">Figure 75</a>
	Falling Edge, Code FFFFh to 0h		<a href="#">Figure 76</a>
Half-Scale Settling Time	Rising Edge, Code 4000h to C000h		<a href="#">Figure 77</a>
	Falling Edge, Code C000h to 4000h		<a href="#">Figure 78</a>

### 7.7.2 Internal Reference

At  $T_A = 25^\circ\text{C}$ ,  $AV_{DD} = 5.5\text{ V}$ , gain = 2 and  $V_{REFOUT}$ , unloaded unless otherwise noted.

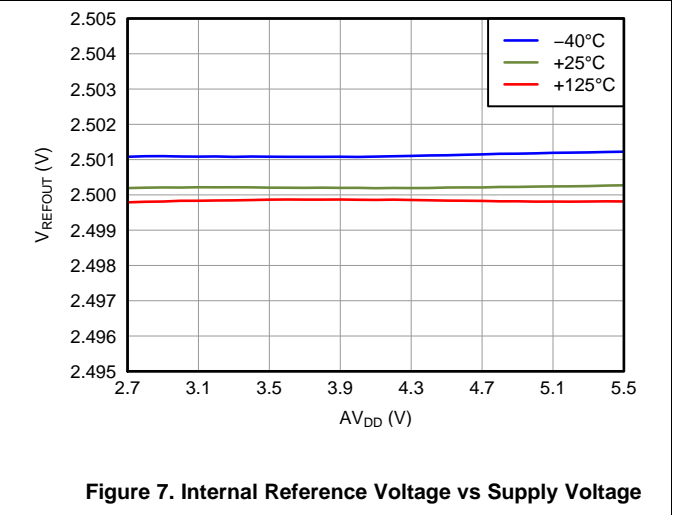
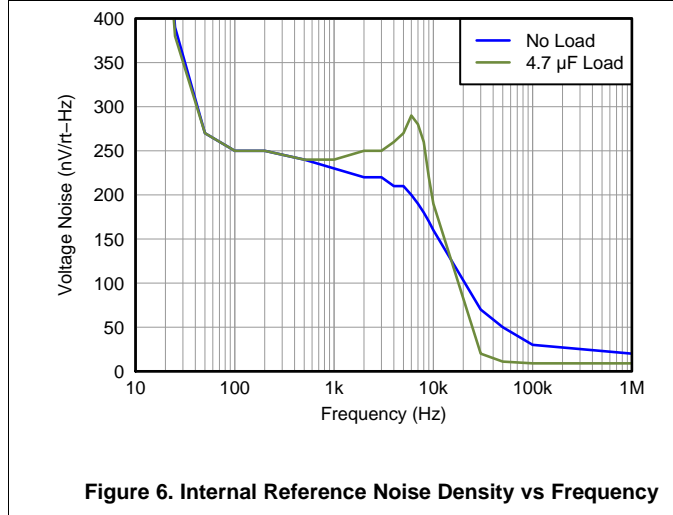
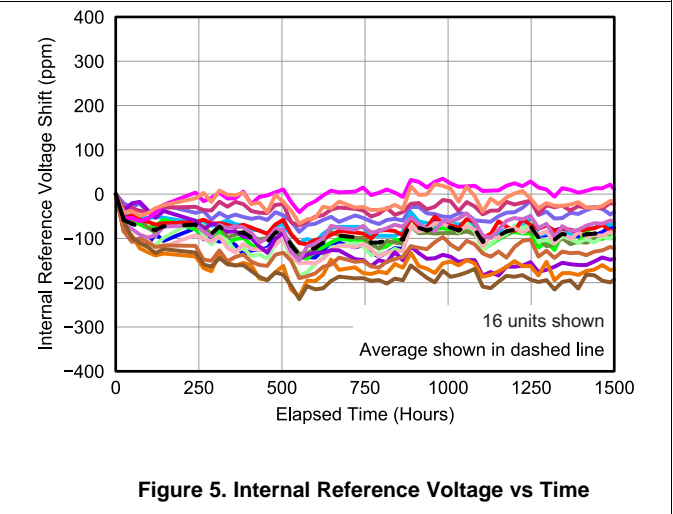
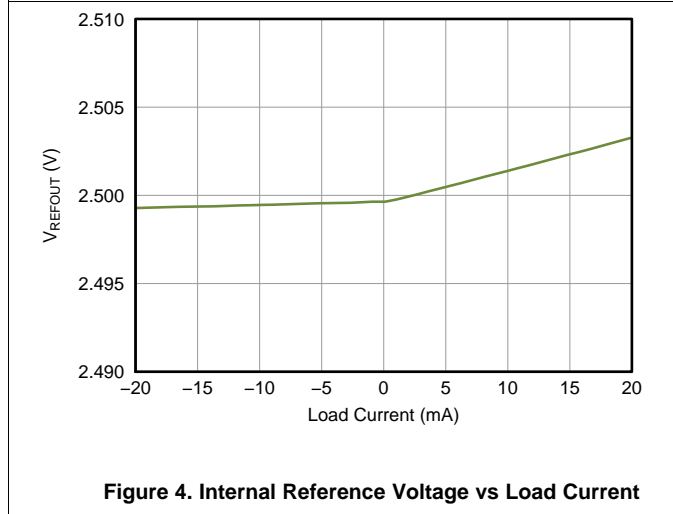
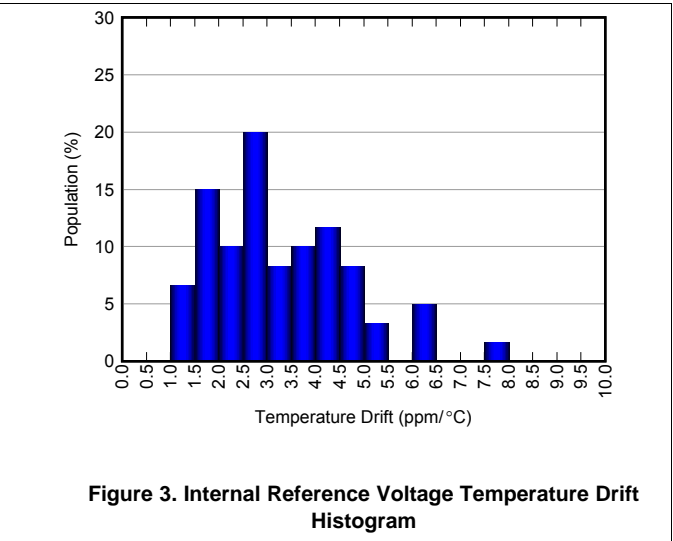
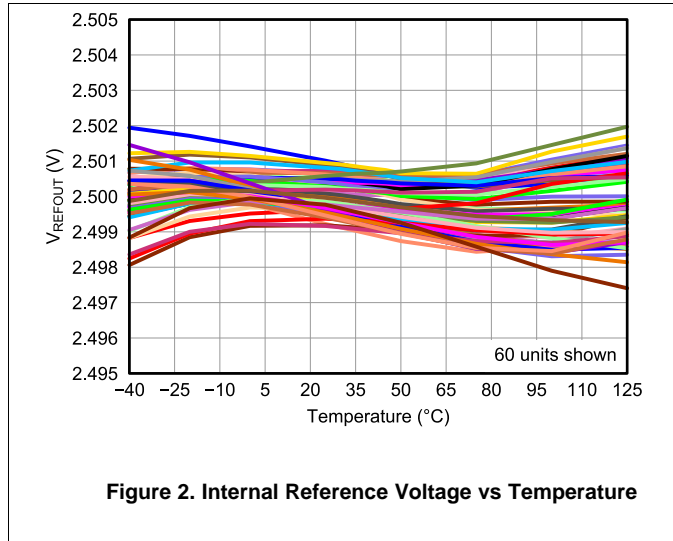

### 7.7.3 DAC at $AV_{DD} = 5.5\text{ V}$

At  $T_A = 25^\circ\text{C}$ , 5-V external reference used, gain = 1 and DAC output not loaded, unless otherwise noted.

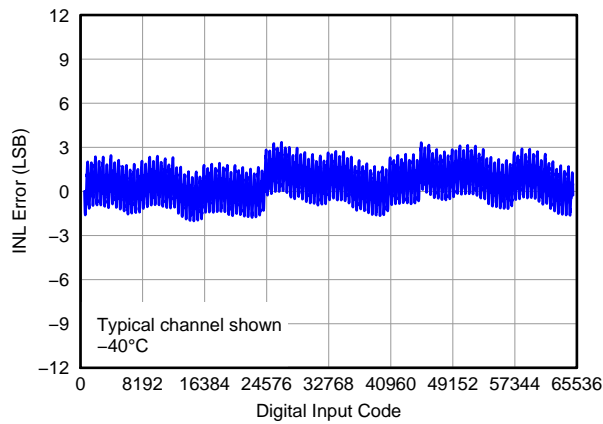

Figure 8. Linearity Error vs Digital Input Code ( $-40^\circ\text{C}$ )

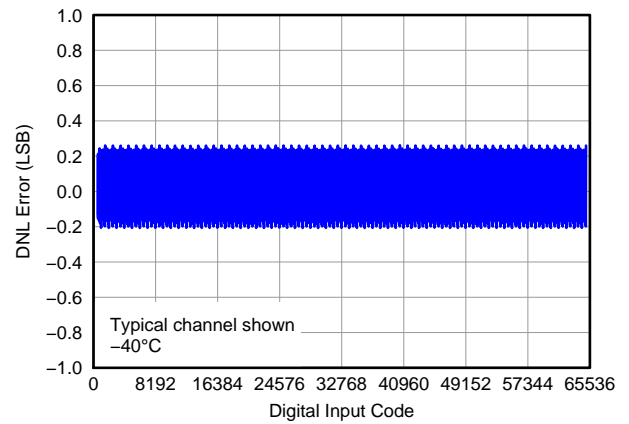

Figure 9. Differential Linearity Error vs Digital Input Code ( $-40^\circ\text{C}$ )

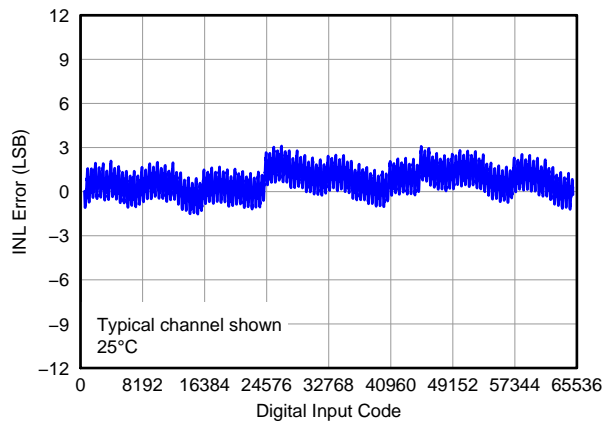

Figure 10. Linearity Error vs Digital Input Code ( $25^\circ\text{C}$ )

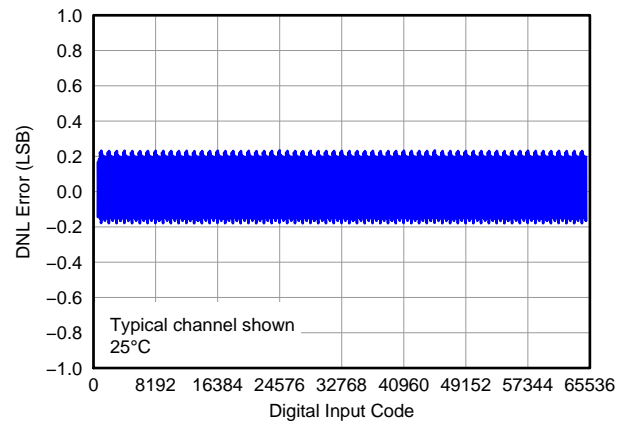

Figure 11. Differential Linearity Error vs Digital Input Code ( $25^\circ\text{C}$ )

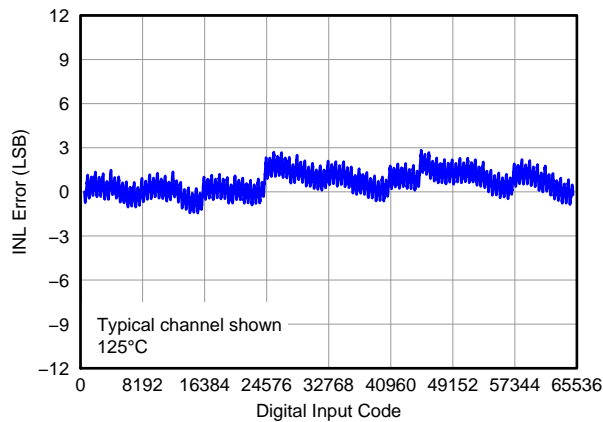

Figure 12. Linearity Error vs Digital Input Code ( $125^\circ\text{C}$ )

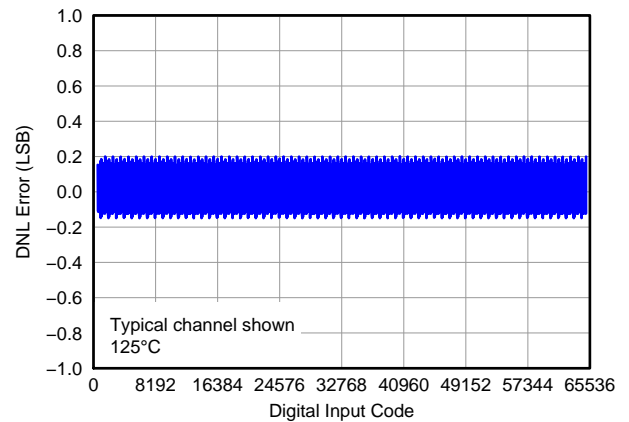
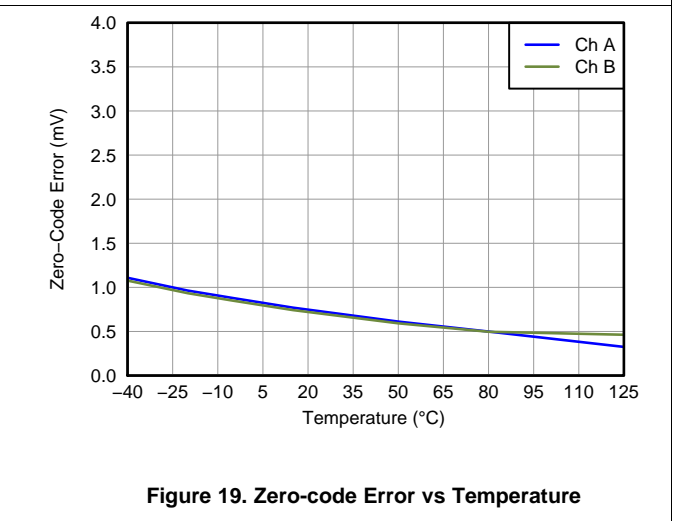
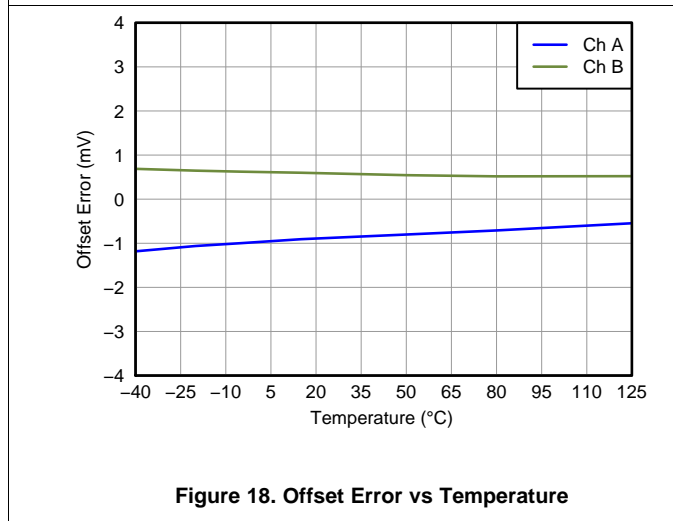
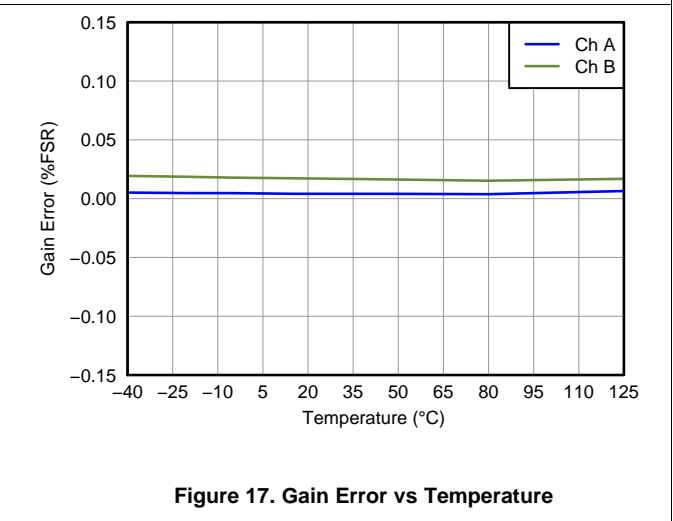
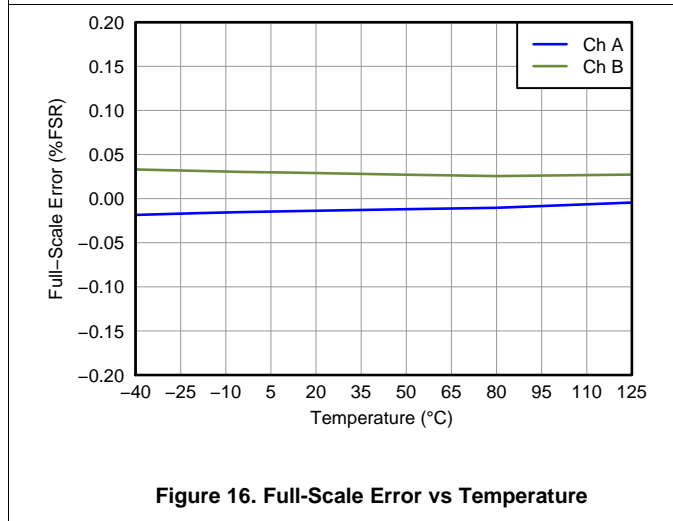
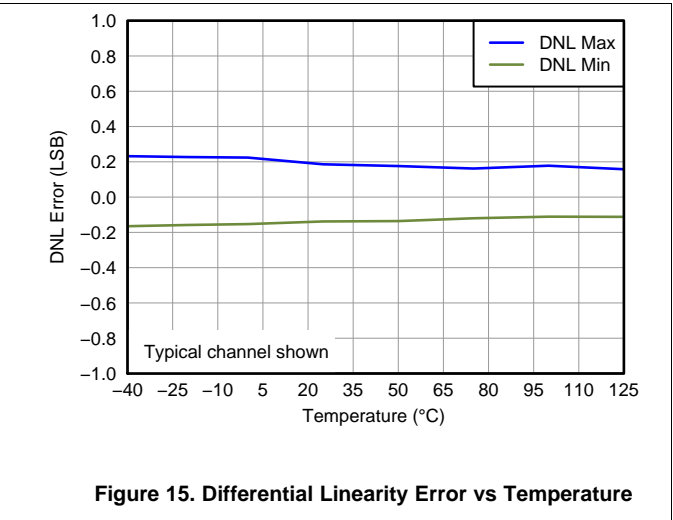
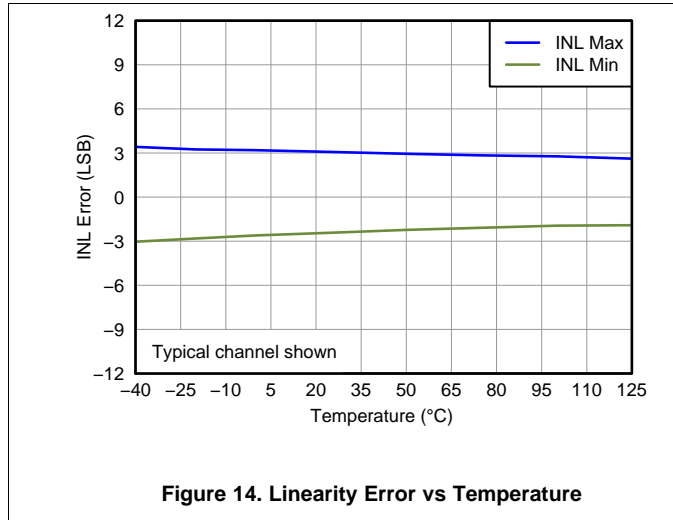

Figure 13. Differential Linearity Error vs Digital Input Code ( $125^\circ\text{C}$ )

**DAC at  $V_{DD} = 5.5\text{ V}$  (continued)**

At  $T_A = 25^\circ\text{C}$ , 5-V external reference used, gain = 1 and DAC output not loaded, unless otherwise noted.



**DAC at  $V_{DD} = 5.5\text{ V}$  (continued)**

At  $T_A = 25^\circ\text{C}$ , 5-V external reference used, gain = 1 and DAC output not loaded, unless otherwise noted.

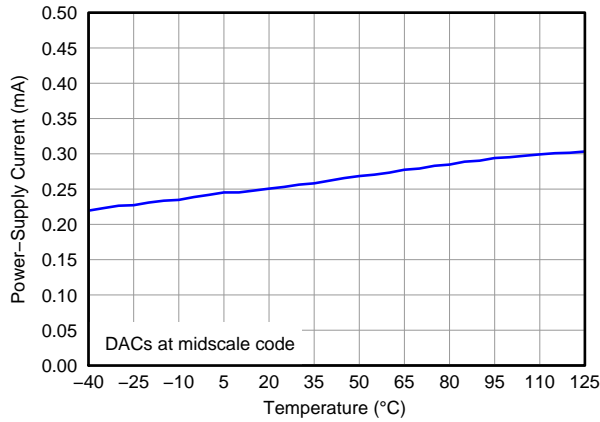

**Figure 20. Power-supply Current vs Temperature**

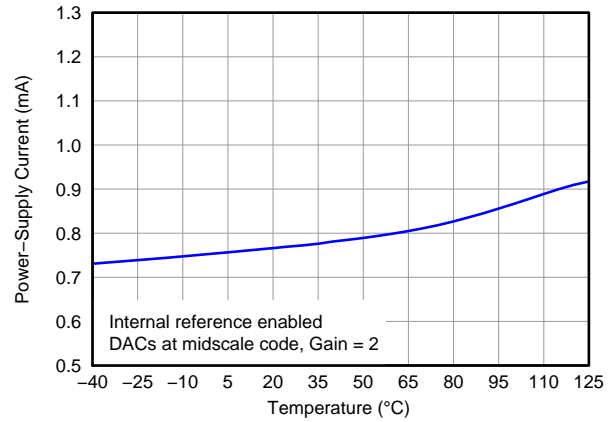

**Figure 21. Power-supply Current vs Temperature**

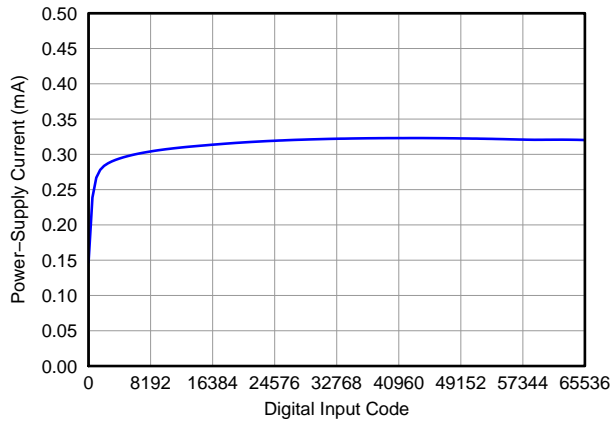

**Figure 22. Power-Supply Current vs Digital Input Code**

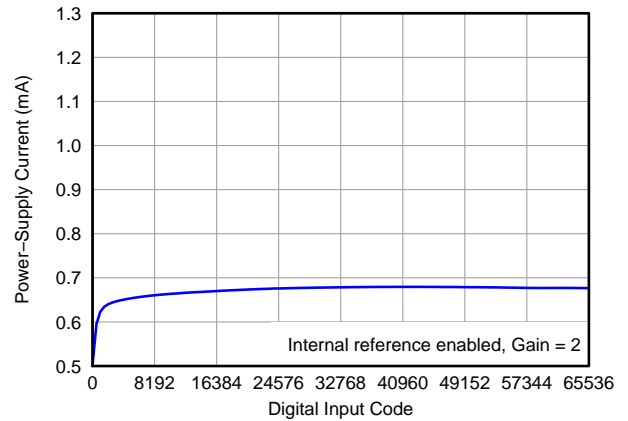

**Figure 23. Power-Supply Current vs Digital Input Code**

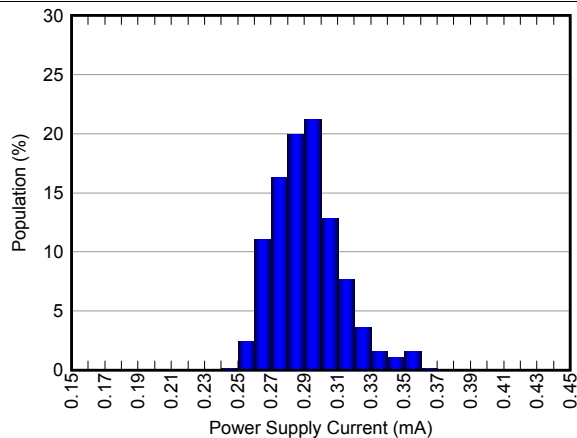

**Figure 24. Power-Supply Current Histogram**

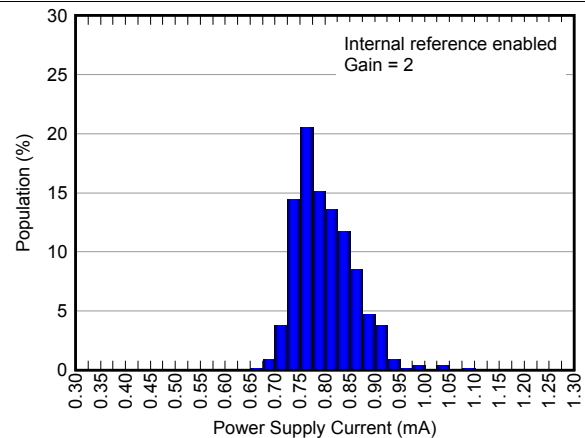

**Figure 25. Power-Supply Current Histogram**

**DAC at  $V_{DD} = 5.5\text{ V}$  (continued)**

At  $T_A = 25^\circ\text{C}$ , 5-V external reference used, gain = 1 and DAC output not loaded, unless otherwise noted.

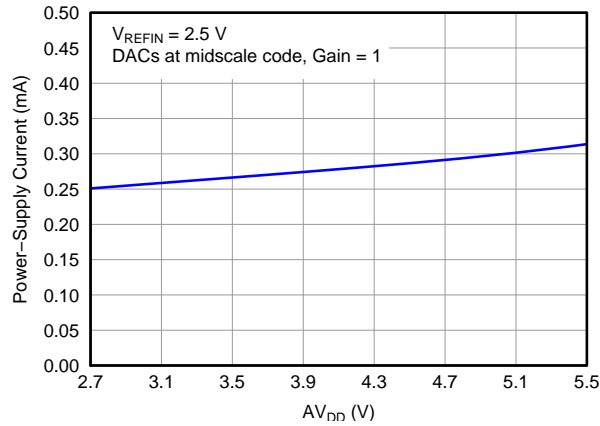

Figure 26. Power-Supply Current vs Power-Supply Voltage

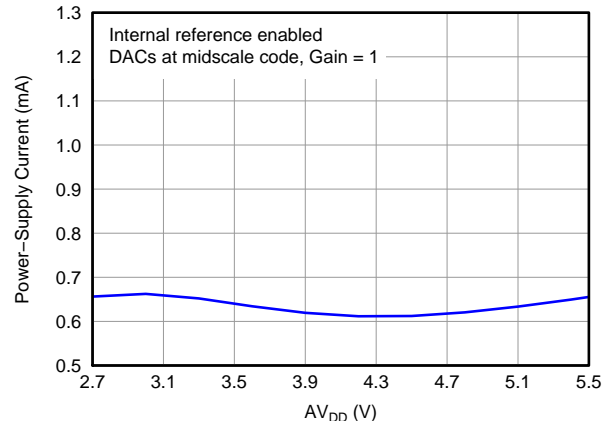

Figure 27. Power-Supply Current vs Power-Supply Voltage

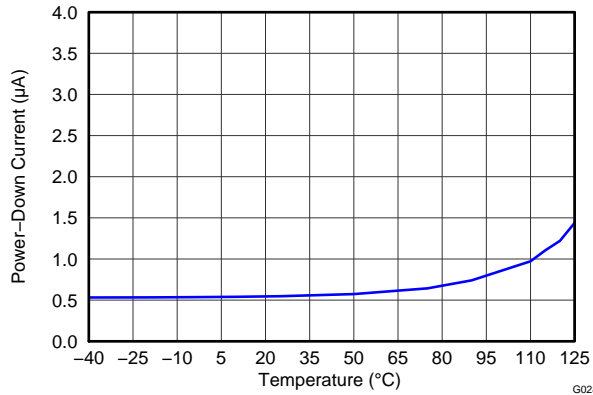

Figure 28. Power-Down Current vs Temperature

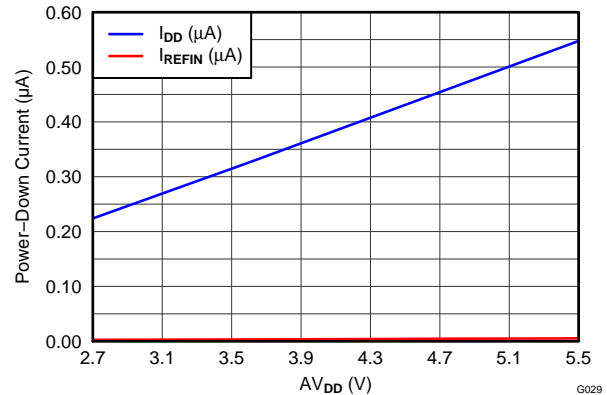

Figure 29. Power-Down Current vs Power-Supply Voltage

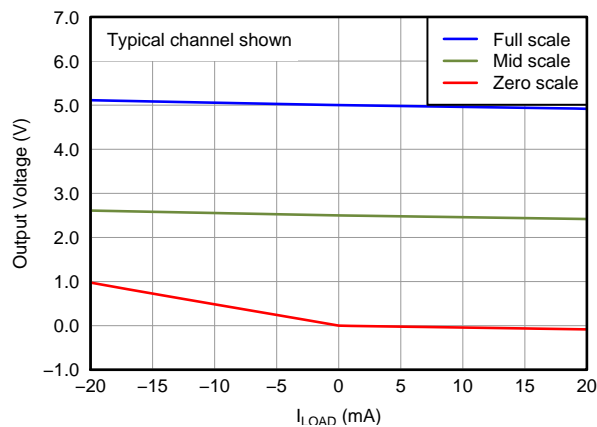

Figure 30. DAC Output Voltage vs Load Current

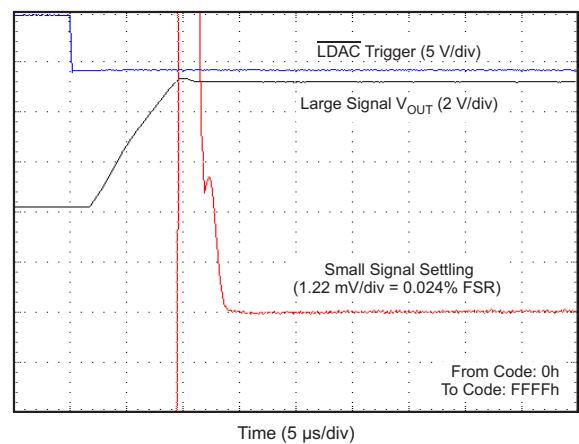

Figure 31. Full-Scale Settling Time: Rising Edge



## DAC at $AV_{DD} = 5.5\text{ V}$ (continued)

At  $T_A = 25^\circ\text{C}$ , 5-V external reference used, gain = 1 and DAC output not loaded, unless otherwise noted.

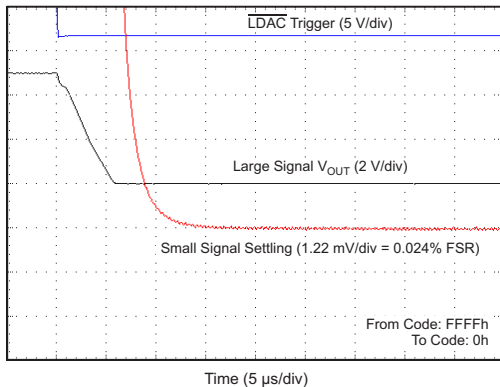

Figure 32. Full-Scale Settling Time: Falling Edge

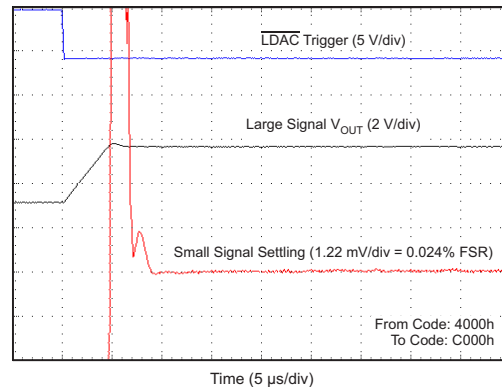

Figure 33. Half-Scale Settling Time: Rising Edge

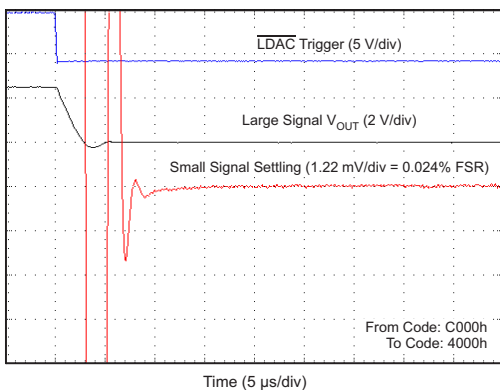

Figure 34. Half-Scale Settling Time: Falling Edge

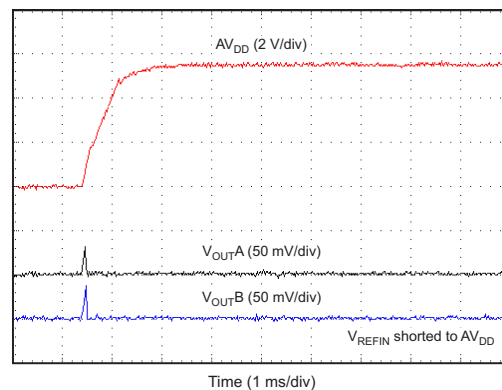

Figure 35. Power-On Glitch Reset to Zero Scale

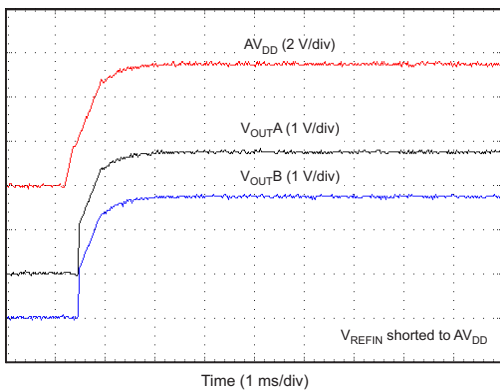

Figure 36. Power-On Glitch Reset to Mid-Scale

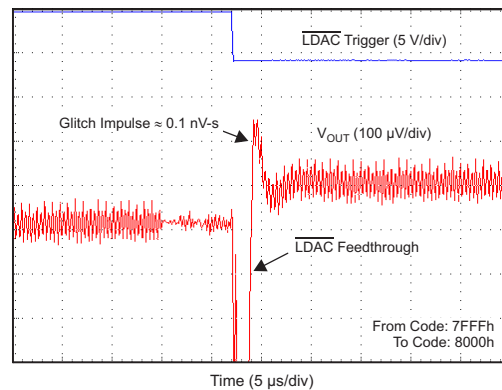

Figure 37. Glitch Impulse Rising Edge, 1-LSB Step

DAC at  $AV_{DD} = 5.5\text{ V}$  (continued)

At  $T_A = 25^\circ\text{C}$ , 5-V external reference used, gain = 1 and DAC output not loaded, unless otherwise noted.

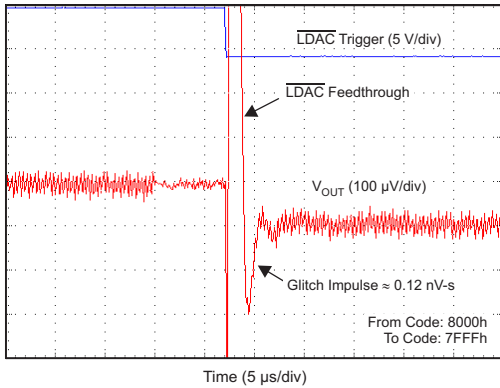

Figure 38. Glitch Impulse Falling Edge, 1-LSB Step

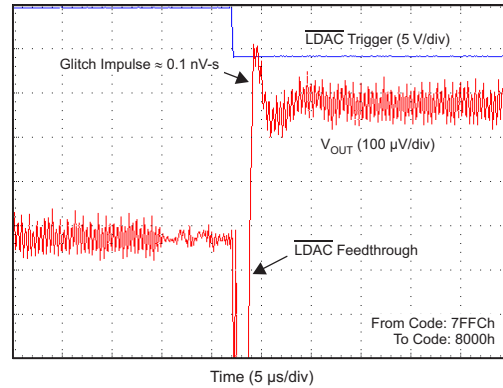

Figure 39. Glitch Impulse Rising Edge, 4-LSB Step

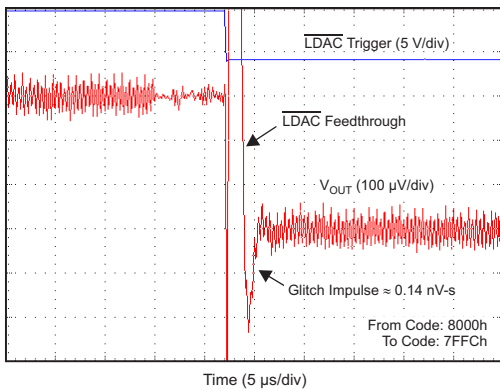

Figure 40. Glitch Impulse Falling Edge, 4-LSB Step

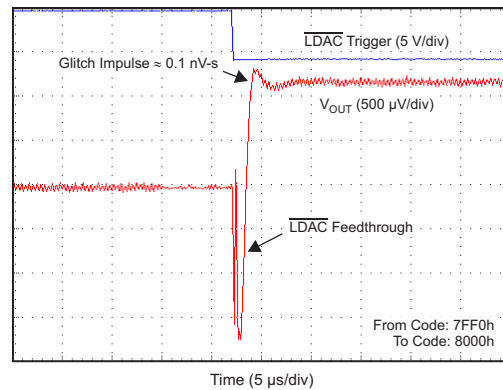

Figure 41. Glitch Impulse Rising Edge, 16-LSB Step

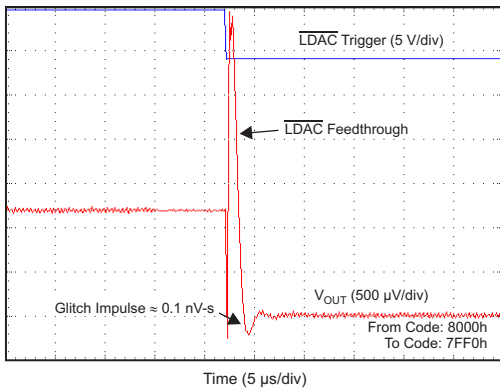

Figure 42. Glitch Impulse Falling Edge, 16-LSB Step

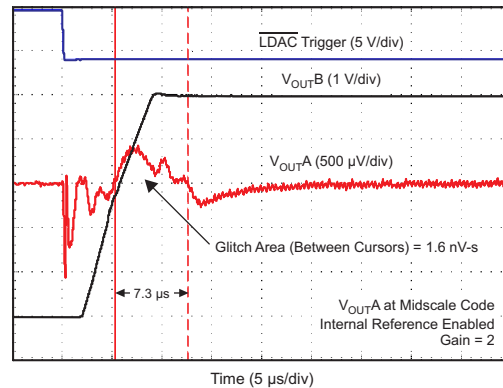

Figure 43. Channel-to-Channel Crosstalk 5-V Rising Edge

### DAC at $AV_{DD} = 5.5\text{ V}$ (continued)

At  $T_A = 25^\circ\text{C}$ , 5-V external reference used, gain = 1 and DAC output not loaded, unless otherwise noted.

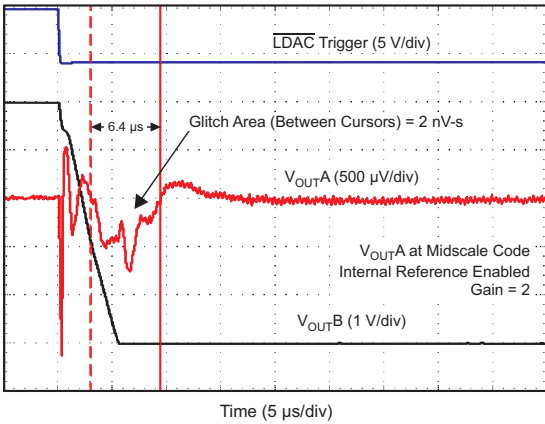

Figure 44. Channel-to-Channel Crosstalk 5-V Falling Edge

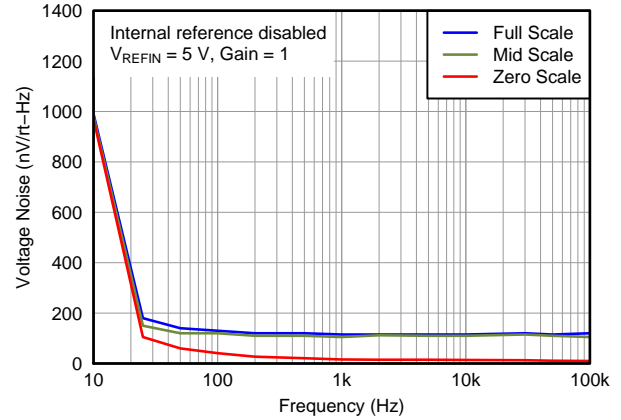

Figure 45. DAC Output Noise Density vs Frequency

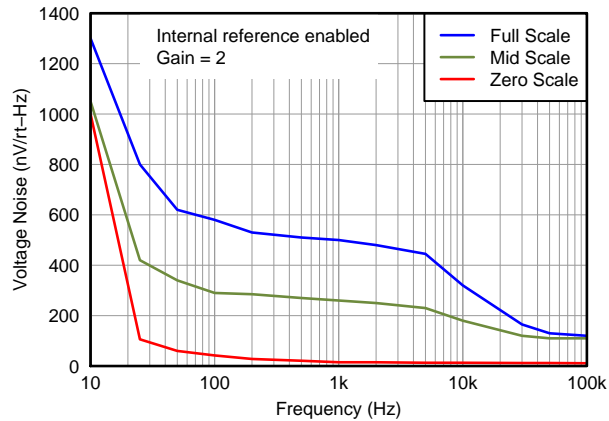

Figure 46. DAC Output Noise Density vs Frequency

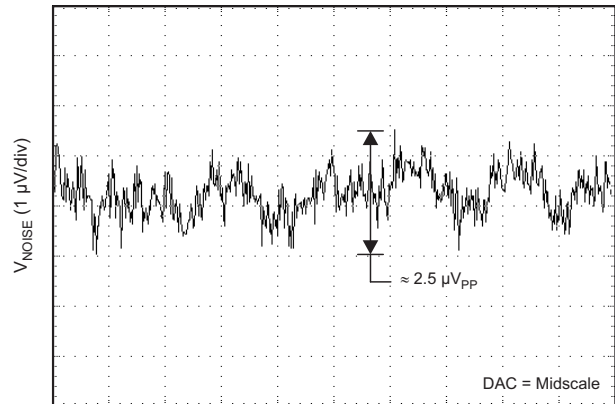

Figure 47. DAC Output Noise 0.1 Hz TO 10 Hz

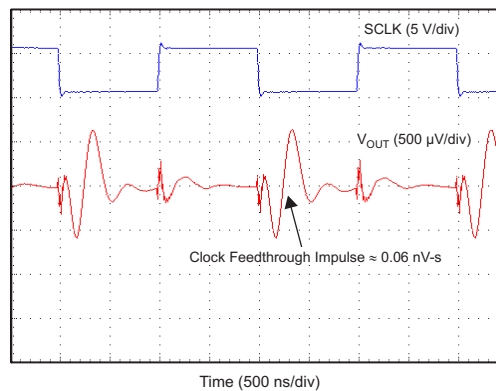

Figure 48. Clock Feedthrough 500 kHz, Mid-Scale

### 7.7.4 Typical Characteristics: DAC at $AV_{DD} = 3.6\text{ V}$

At  $T_A = 25^\circ\text{C}$ , 3.3-V external reference used, gain = 1 and DAC output not loaded, unless otherwise noted.

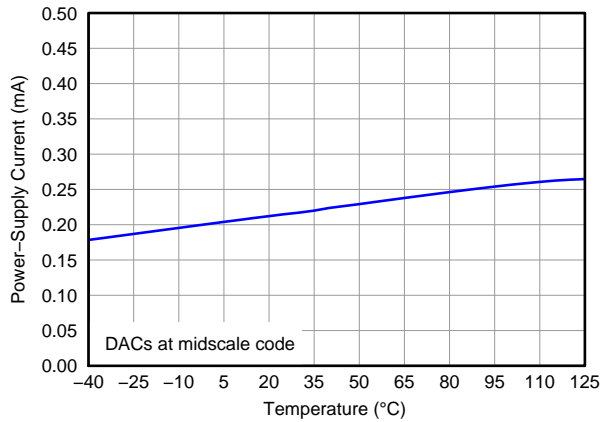

Figure 49. Power-Supply Current vs Temperature

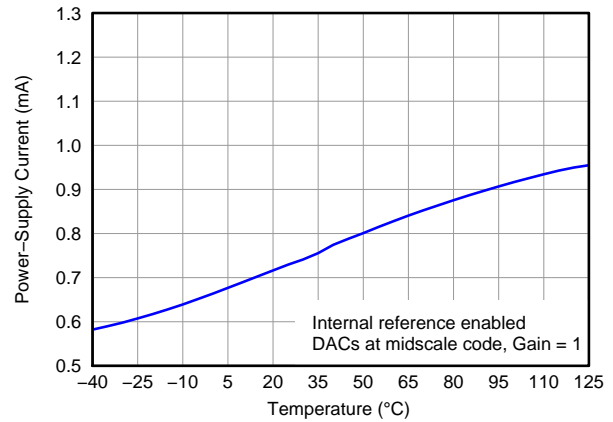

Figure 50. Power-Supply Current vs Temperature

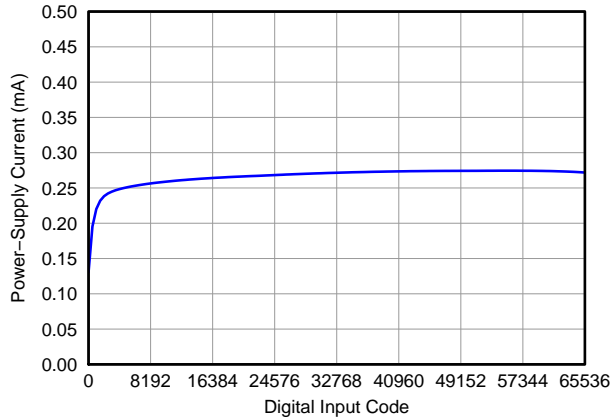

Figure 51. Power-Supply Current vs Digital Input Code

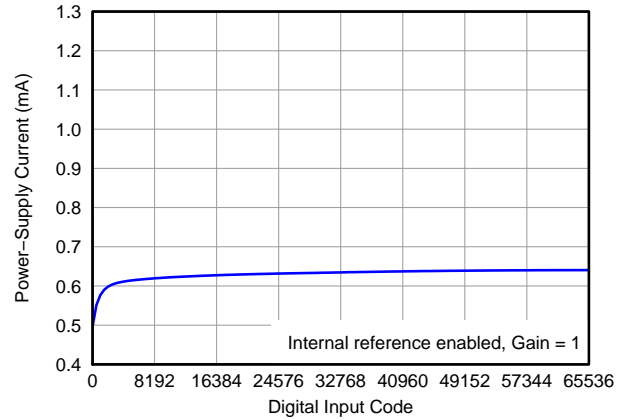

Figure 52. Power-Supply Current vs Digital Input Code

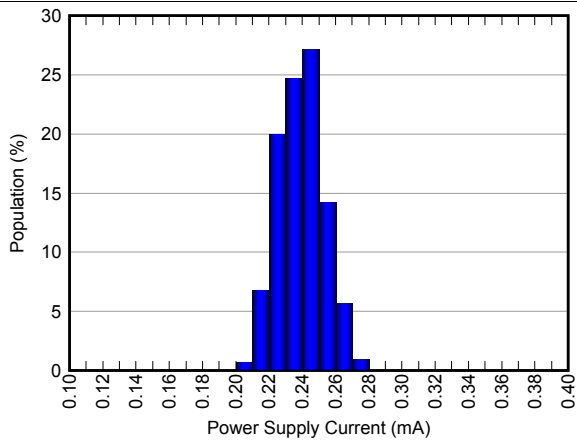

Figure 53. Power-Supply Current Histogram

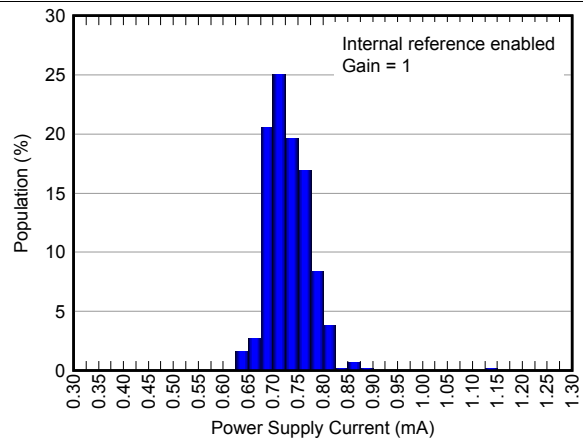

Figure 54. Power-Supply Current Histogram

### 7.7.5 Typical Characteristics: DAC at $AV_{DD} = 2.7\text{ V}$

At  $T_A = 25^\circ\text{C}$ , 2.5-V external reference used, gain = 1 and DAC output not loaded, unless otherwise noted.

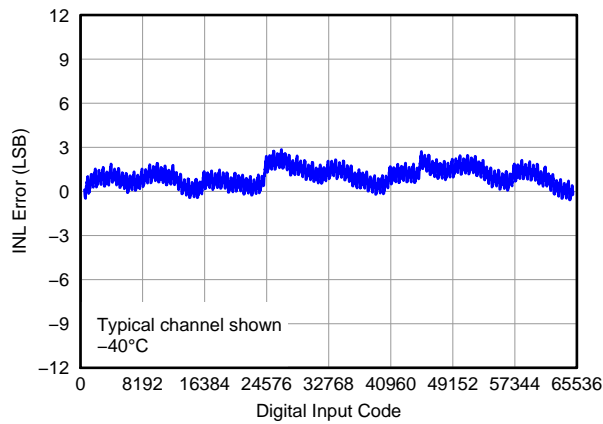

Figure 55. Linearity Error vs Digital Input Code ( $-40^\circ\text{C}$ )

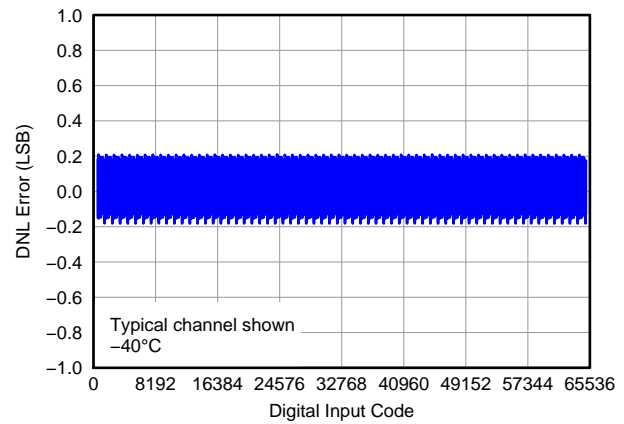

Figure 56. Differential Linearity Error vs Digital Input Code ( $-40^\circ\text{C}$ )

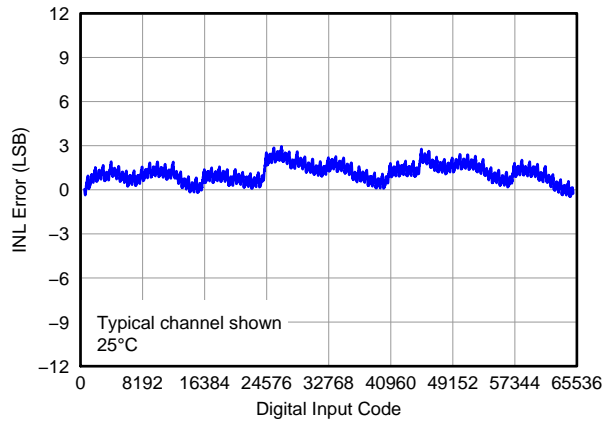

Figure 57. Linearity Error vs Digital Input Code ( $25^\circ\text{C}$ )

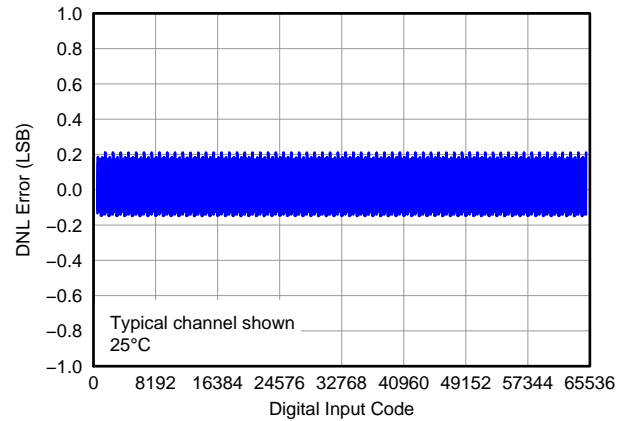

Figure 58. Differential Linearity Error vs Digital Input Code ( $25^\circ\text{C}$ )

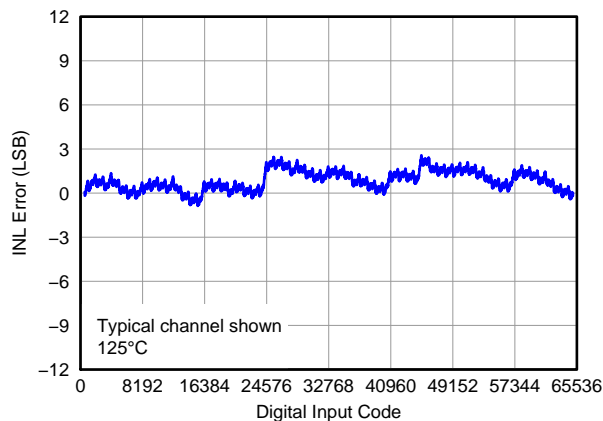

Figure 59. Linearity Error vs Digital Input Code ( $125^\circ\text{C}$ )

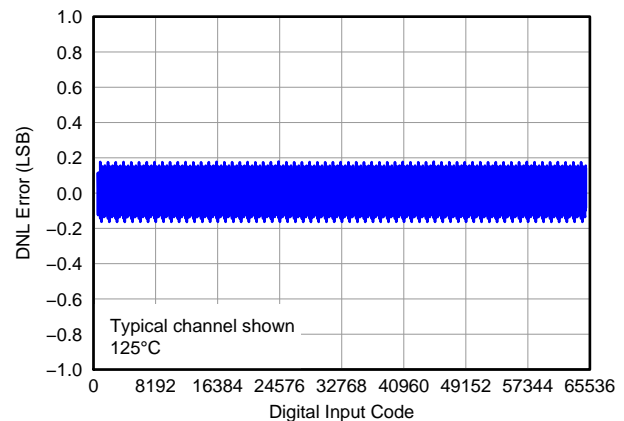

Figure 60. Differential Linearity Error vs Digital Input Code ( $125^\circ\text{C}$ )

### Typical Characteristics: DAC at AV<sub>DD</sub> = 2.7 V (continued)

At T<sub>A</sub> = 25°C, 2.5-V external reference used, gain = 1 and DAC output not loaded, unless otherwise noted.

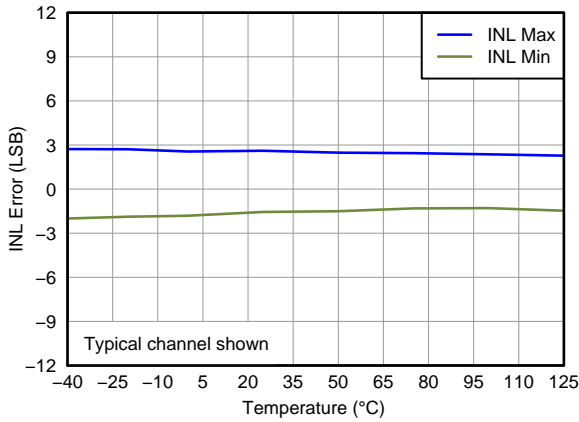

Figure 61. Linearity Error vs Temperature

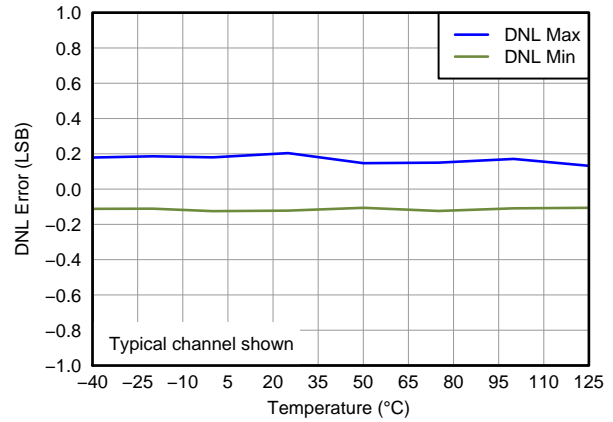

Figure 62. Differential Linearity Error vs Temperature

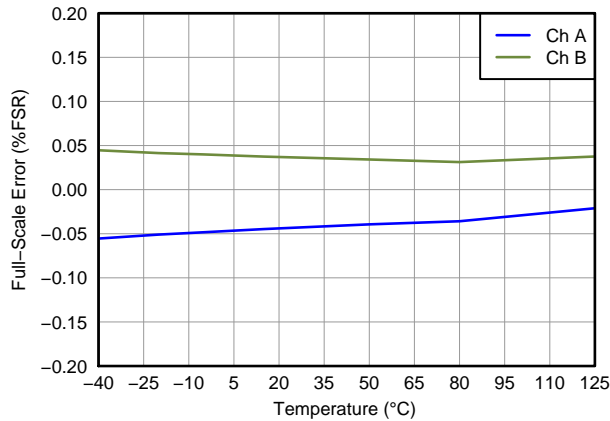

Figure 63. Full-Scale Error vs Temperature

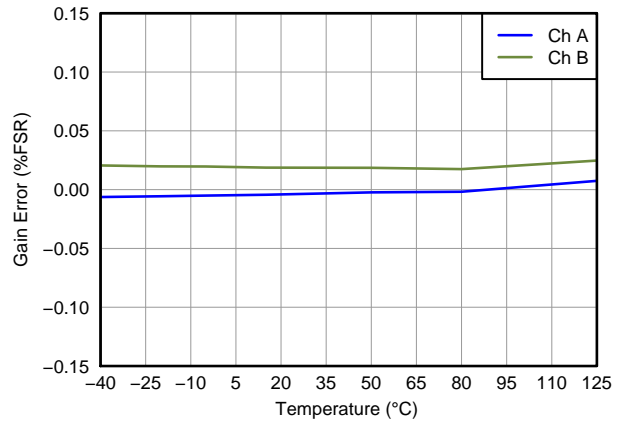

Figure 64. Gain Error vs Temperature

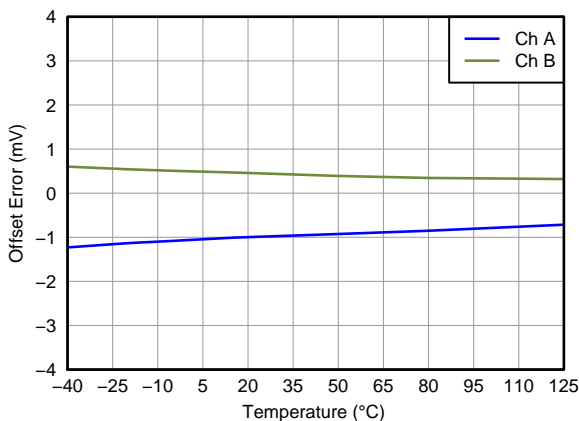

Figure 65. Offset Error vs Temperature

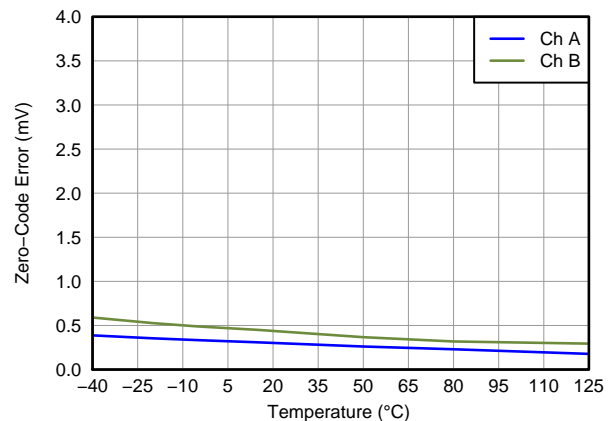

Figure 66. Zero-Code Error vs Temperature

**Typical Characteristics: DAC at  $V_{DD} = 2.7\text{ V}$  (continued)**

At  $T_A = 25^\circ\text{C}$ , 2.5-V external reference used, gain = 1 and DAC output not loaded, unless otherwise noted.

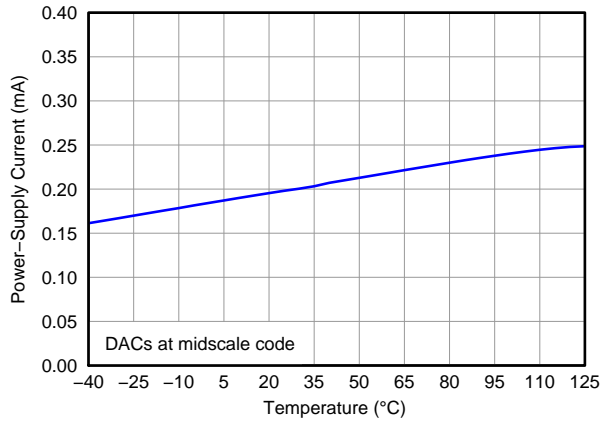

Figure 67. Power-Supply Current vs Temperature

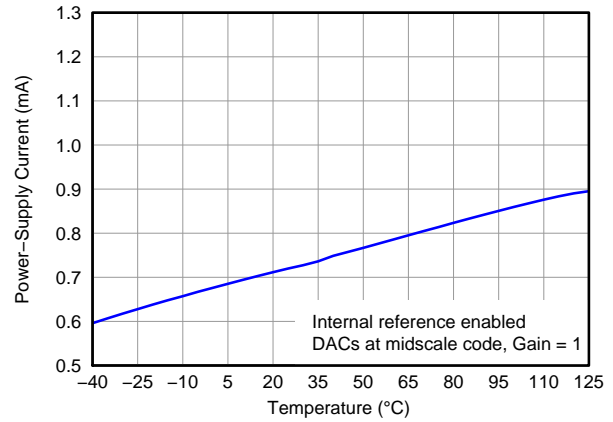

Figure 68. Power-Supply Current vs Temperature

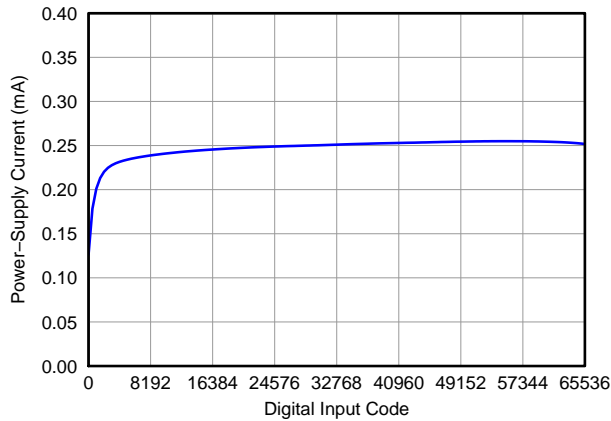

Figure 69. Power-Supply Current vs Digital Input Code

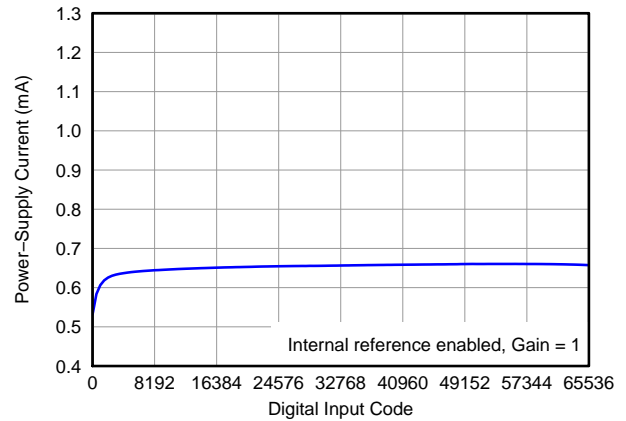

Figure 70. Power-Supply Current vs Digital Input Code

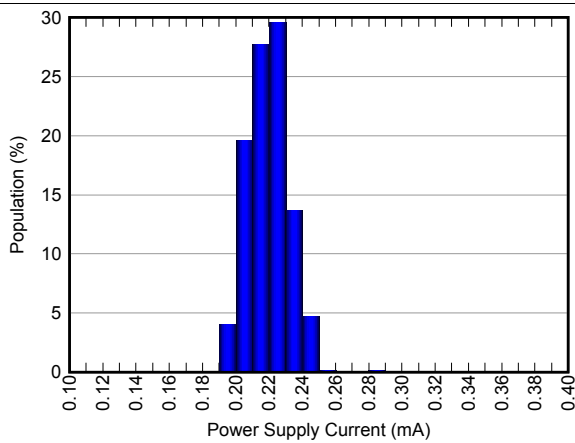

Figure 71. Power-Supply Current Histogram

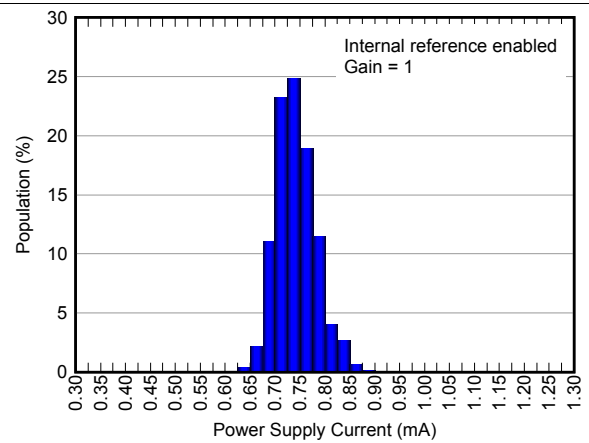

Figure 72. Power-Supply Current Histogram



Typical Characteristics: DAC at  $AV_{DD} = 2.7\text{ V}$  (continued)

At  $T_A = 25^\circ\text{C}$ , 2.5-V external reference used, gain = 1 and DAC output not loaded, unless otherwise noted.

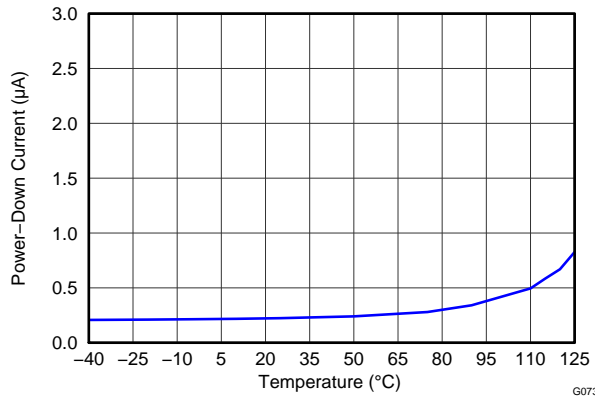

Figure 73. Power-Down Current vs Temperature

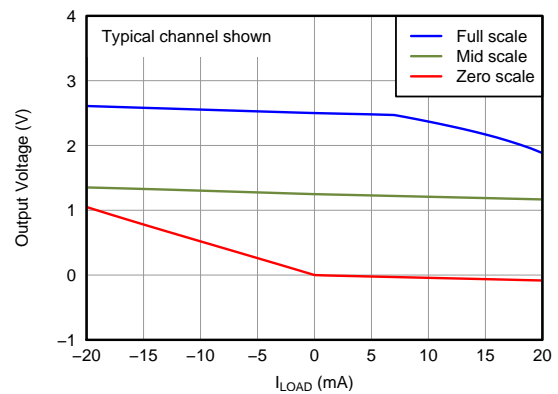

Figure 74. DAC Output Voltage vs Load Current

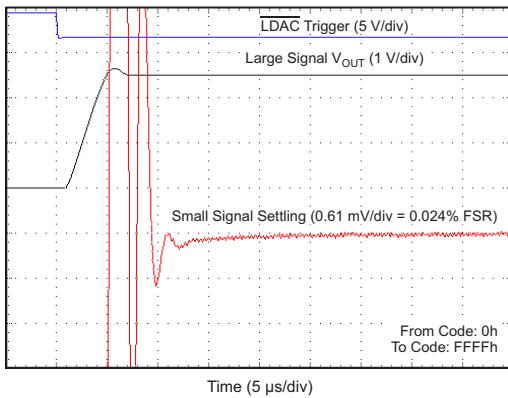

Figure 75. Full-Scale Settling Time: Rising Edge

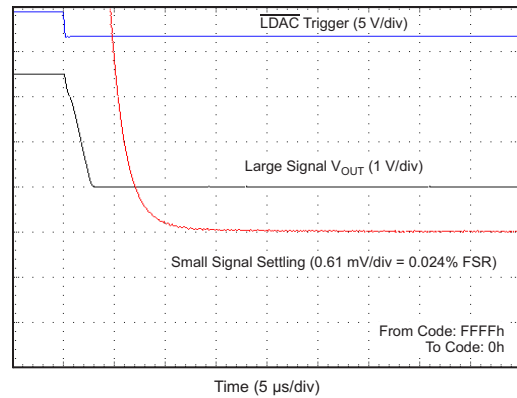

Figure 76. Full-Scale Settling Time: Falling Edge

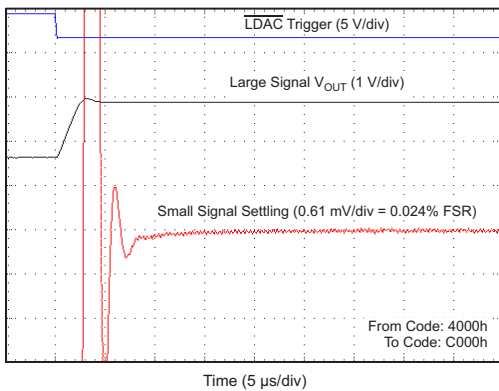

Figure 77. Half-Scale Settling Time: Rising Edge

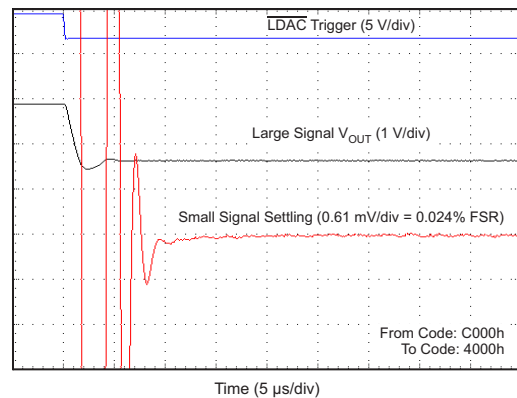
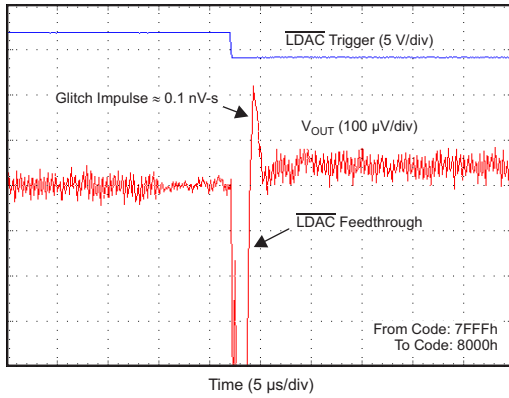

Figure 78. Half-Scale Settling Time: Falling Edge

**Typical Characteristics: DAC at  $AV_{DD} = 2.7\text{ V}$  (continued)**

At  $T_A = 25^\circ\text{C}$ , 2.5-V external reference used, gain = 1 and DAC output not loaded, unless otherwise noted.



**Figure 79. Glitch Impulse Rising Edge, 1-LSB Step**

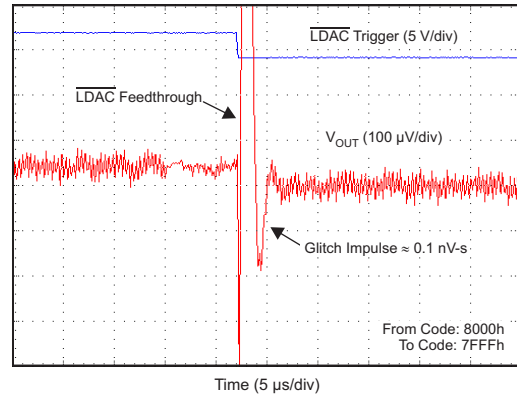

**Figure 80. Glitch Impulse Falling Edge, 1-LSB Step**

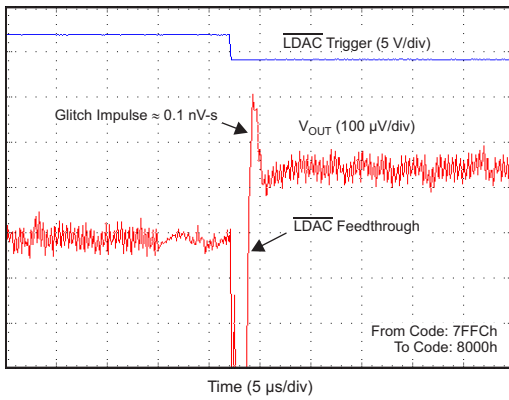

**Figure 81. Glitch Impulse Rising Edge, 4-LSB Step**

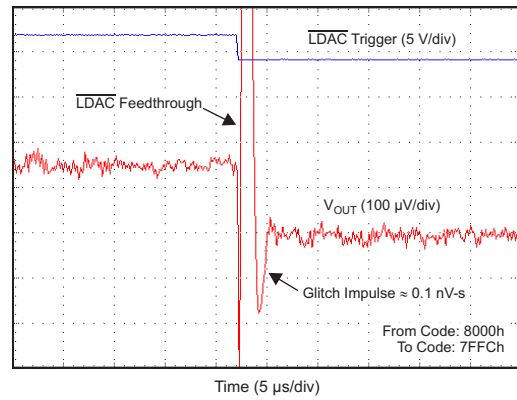

**Figure 82. Glitch Impulse Falling Edge, 4-LSB Step**

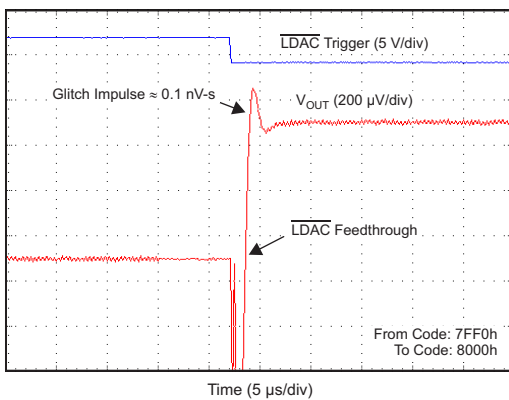

**Figure 83. Glitch Impulse Rising Edge, 16-LSB Step**

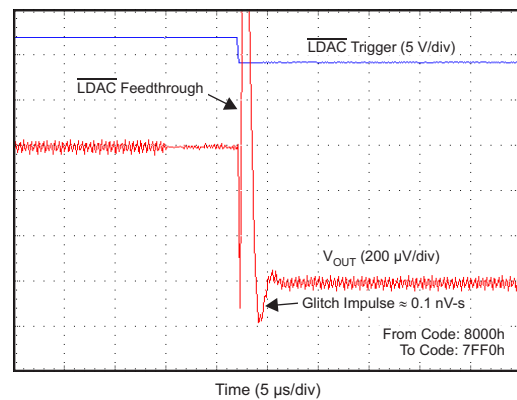

**Figure 84. Glitch Impulse Falling Edge, 16-LSB Step**

### Typical Characteristics: DAC at $AV_{DD} = 2.7\text{ V}$ (continued)

At  $T_A = 25^\circ\text{C}$ , 2.5-V external reference used, gain = 1 and DAC output not loaded, unless otherwise noted.

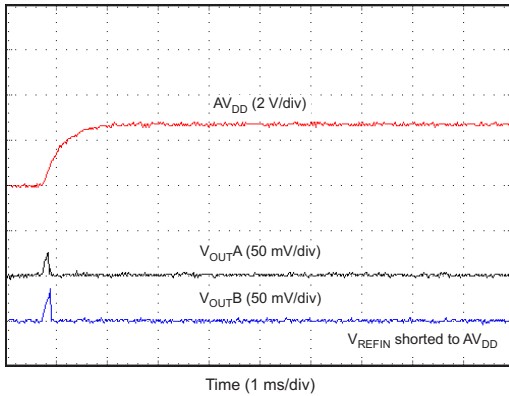

Figure 85. Power-On Glitch Reset to Zero Scale

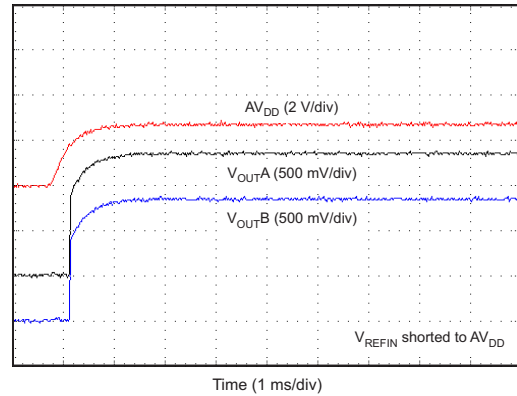

Figure 86. Power-On Glitch Reset to Mid-Scale

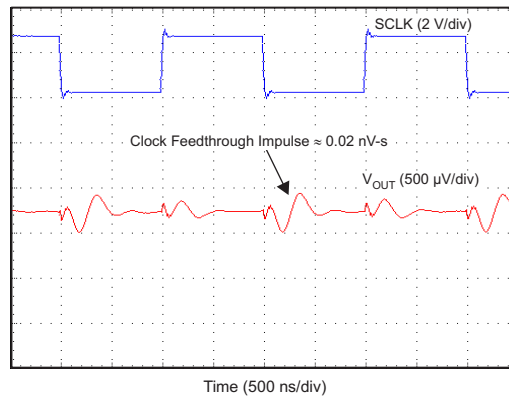

Figure 87. Clock Feedthrough 500 kHz, Mid-Scale

## 8 Detailed Description

### 8.1 Overview

The DAC756x-Q1, DAC816x-Q1, and DAC856x-Q1 devices are low-power, voltage-output, dual-channel, 12-, 14-, and 16-bit digital-to-analog converters (DACs), respectively. These devices include a 2.5-V, 4-ppm/°C internal reference, giving a full-scale output voltage range of 2.5 V or 5 V. The internal reference has an initial accuracy of ±5 mV and can source or sink up to 20 mA at the  $V_{REFIN}/V_{REFOUT}$  pin.

### 8.2 Functional Block Diagram

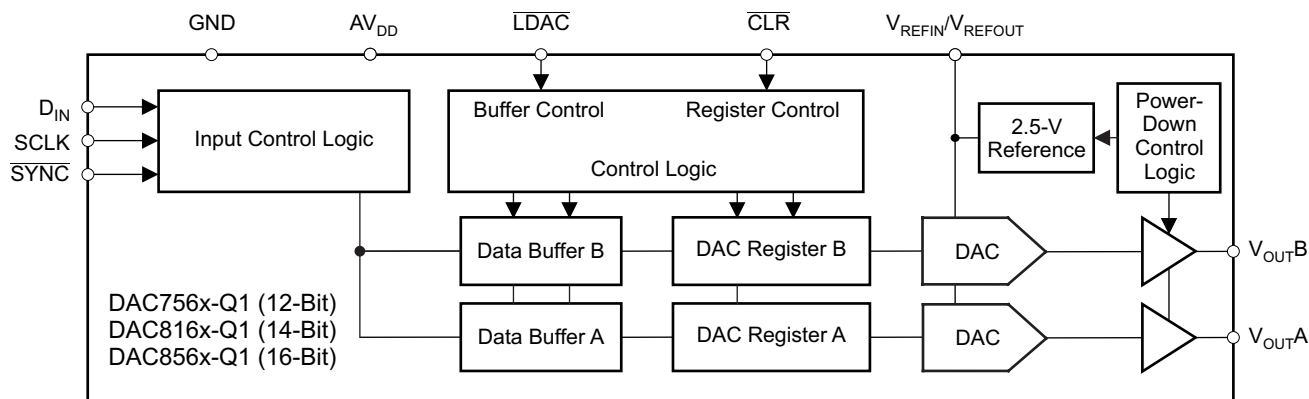

### 8.3 Feature Description

#### 8.3.1 Digital-to-Analog Converter (DAC)

The DAC756x-Q1, DAC816x-Q1, and DAC856x-Q1 architecture consists of two string DACs, each followed by an output buffer amplifier. The devices include an internal 2.5-V reference with 4-ppm/°C temperature drift performance. Figure 88 shows a principal block diagram of the DAC architecture.

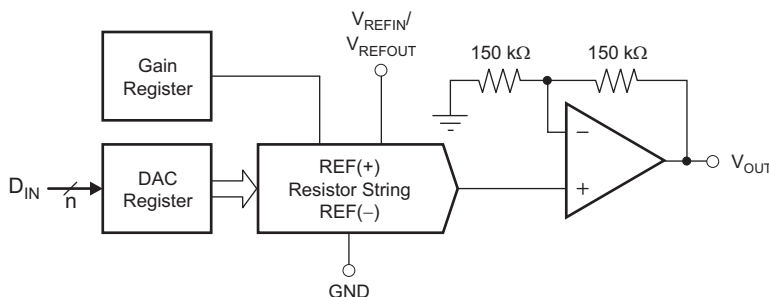

Figure 88. DAC Architecture

The input coding to the DAC756x-Q1, DAC816x-Q1, and DAC856x-Q1 devices is straight binary, so the ideal output voltage is given by Equation 1:

$$V_{OUT} = \left( \frac{D_{IN}}{2^n} \right) \times V_{REF} \times \text{Gain} \quad (1)$$

where:

$n$  = resolution in bits; either 12 (DAC756x-Q1), 14 (DAC816x-Q1) or 16 (DAC856x-Q1)

$D_{IN}$  = decimal equivalent of the binary code that is loaded to the DAC register.  $D_{IN}$  ranges from 0 to  $2^n - 1$ .  
 $V_{REF}$  = DAC reference voltage; either  $V_{REFOUT}$  from the internal 2.5-V reference or  $V_{REFIN}$  from an external reference.

Gain = 1 by default when internal reference is disabled (using external reference), and gain = 2 by default when using internal reference. Gain can also be manually set to either 1 or 2 using the gain register. See the [Gain Function](#) section for more information.

## Feature Description (continued)

### 8.3.1.1 Resistor String

The resistor string section is shown in [Figure 89](#). It is simply a string of resistors, each of value  $R$ . The code loaded into the DAC register determines at which node on the string the voltage is tapped off to be fed into the output amplifier by closing one of the switches connecting the string to the amplifier. The resistor string architecture results in monotonicity. The  $R_{\text{DIVIDER}}$  switch is controlled by the gain registers (see the [Gain Function](#) section). Because the output amplifier has a gain of 2,  $R_{\text{DIVIDER}}$  is not shorted when the DAC-n gain is set to 1 (default if internal reference is disabled), and is shorted when the DAC-n gain is set to 2 (default if internal reference is enabled).

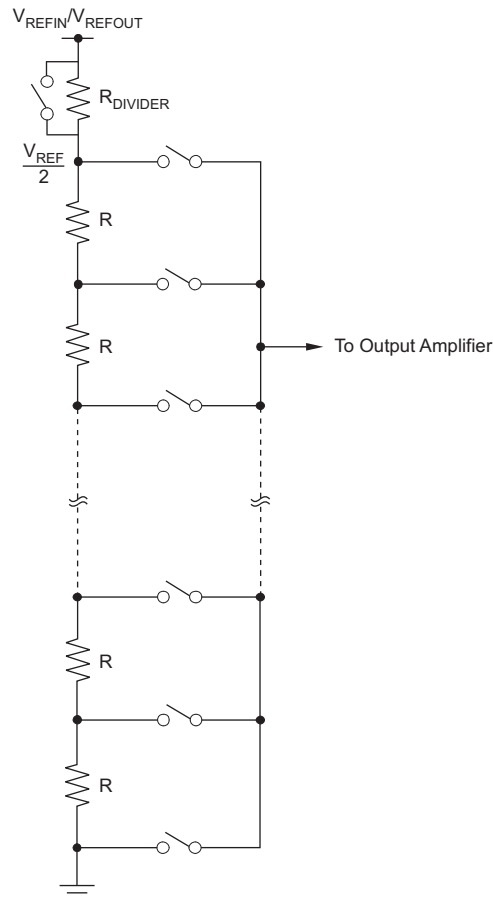

Figure 89. Resistor String

### 8.3.1.2 Output Amplifier

The output buffer amplifier is capable of generating rail-to-rail voltages on its output, giving a maximum output range of 0 V to  $AV_{\text{DD}}$ . It is capable of driving a load of 2 k $\Omega$  in parallel with 3 nF to GND. The typical slew rate is 0.75 V/ $\mu\text{s}$ , with a typical full-scale settling time of 14  $\mu\text{s}$  as shown in [Figure 31](#), [Figure 32](#), [Figure 75](#) and [Figure 76](#).

## Feature Description (continued)

### 8.3.2 Internal Reference

The DAC756x-Q1, DAC816x-Q1, and DAC856x-Q1 devices include a 2.5-V internal reference that is disabled by default. The internal reference is externally available at the  $V_{REFIN}/V_{REFOUT}$  pin. The internal reference output voltage is 2.5 V and can sink and source up to 20 mA.

A minimum 150-nF capacitor is recommended between the reference output and GND for noise filtering.

The internal reference of the DAC756x-Q1, DAC816x-Q1, and DAC856x-Q1 devices is a bipolar transistor-based precision band-gap voltage reference. Figure 90 shows the basic band-gap topology. Transistors  $Q_1$  and  $Q_2$  are biased such that the current density of  $Q_1$  is greater than that of  $Q_2$ . The difference of the two base-emitter voltages ( $V_{BE1} - V_{BE2}$ ) has a positive temperature coefficient and is forced across resistor  $R_1$ . This voltage is amplified and added to the base-emitter voltage of  $Q_2$ , which has a negative temperature coefficient. The resulting output voltage is virtually independent of temperature. The short-circuit current is limited by design to approximately 100 mA.

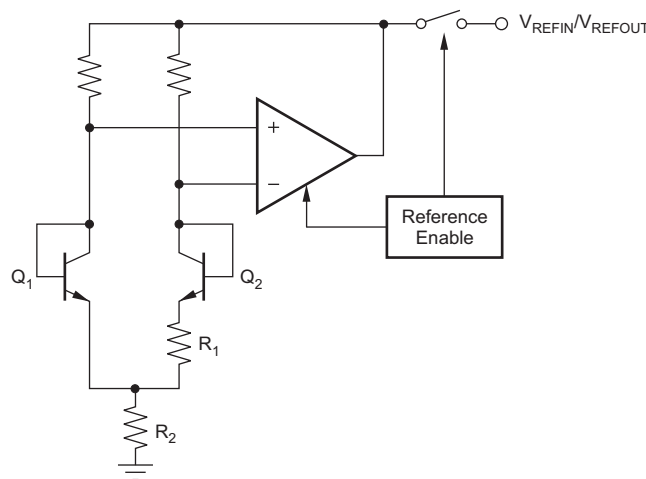

Figure 90. Band-Gap Reference Simplified Schematic

### 8.3.3 Power-On Reset

#### 8.3.3.1 Power-On Reset to Zero-Scale

The DAC7562-Q1, DAC8162-Q1, and DAC8562-Q1 devices contain a power-on-reset circuit that controls the output voltage during power up. All device registers are reset as shown in Table 4. At power up, all DAC registers are filled with zeros and the output voltages of all DAC channels are set to zero volts. Each DAC channel remains that way until a valid load command is written to it. The power-on reset is useful in applications where it is important to know the state of the output of each DAC while the device is in the process of powering up. No device pin should be brought high before applying power to the device. The internal reference is disabled by default and remains that way until a valid reference-change command is executed.

#### 8.3.3.2 Power-On Reset to Mid-Scale

The DAC7563-Q1, DAC8163-Q1, and DAC8563-Q1 devices contain a power-on reset circuit that controls the output voltage during power up. At power up, all DAC registers are reset to mid-scale code and the output voltages of all DAC channels are set to  $V_{REFIN} / 2$  V. Each DAC channel remains that way until a valid load command is written to it. The power-on reset is useful in applications where it is important to know the state of the output of each DAC while the device is in the process of powering up. No device pin should be brought high before applying power to the device. The internal reference is powered off or down by default and remains that way until a valid reference-change command is executed. If using an external reference, it is acceptable to power on the  $V_{REFIN}$  pin either at the same time as or after applying  $AV_{DD}$ .

**Table 4. DACxx62-Q1 and DACxx63-Q1 Power-On Reset Values**

REGISTER	DEFAULT SETTING	
DAC and input registers	DACxx62-Q1	Zero-scale
	DACxx63-Q1	Mid-scale
LDAC registers	LDAC pin enabled for both channels	
Power-down registers	DACs powered up	
Internal reference register	Internal reference disabled	
Gain registers	Gain = 1 for both channels	

### 8.3.3.3 Power-On Reset (POR) Levels

When the device powers up, a POR circuit sets the device in default mode as shown in Table 4. The POR circuit requires specific  $AV_{DD}$  levels, as indicated in Figure 91, to ensure discharging of internal capacitors and to reset the device on power up. In order to ensure a power-on reset,  $AV_{DD}$  must be below 0.7 V for at least 1 ms. When  $AV_{DD}$  drops below 2.2 V but remains above 0.7 V (shown as the undefined region), the device may or may not reset under all specified temperature and power-supply conditions. In this case, TI recommends a power-on reset. When  $AV_{DD}$  remains above 2.2 V, a power-on reset does not occur.

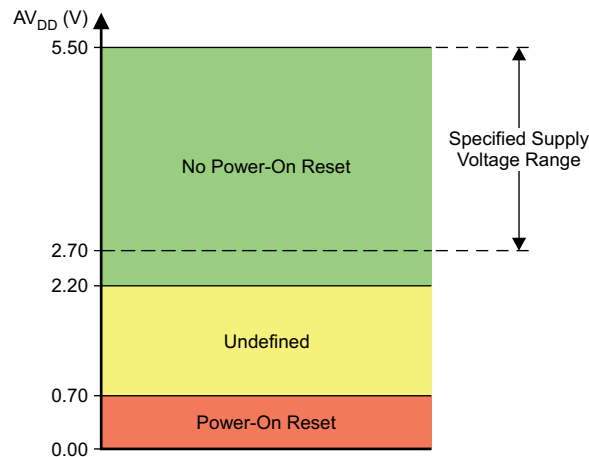

**Figure 91. Relevant Voltage Levels for POR Circuit**



## 8.4 Device Functional Modes

### 8.4.1 Power-Down Modes

The DAC756x-Q1, DAC816x-Q1, and DAC856x-Q1 devices have two separate sets of power-down commands. One set is for the DAC channels and the other set is for the internal reference. The internal reference is forced to a powered-down state while both DAC channels are powered down, and is only enabled if any DAC channel is also in the normal mode of operation. For more information on the internal reference control, see the [Internal Reference Enable Register](#) section.

#### 8.4.1.1 DAC Power-Down Commands

The DAC756x-Q1, DAC816x-Q1, and DAC856x-Q1 DACs use four modes of operation. These modes are accessed by setting the serial interface command bits to 100. Once the command bits are set correctly, the four different power-down modes are software programmable by setting bits DB5 and DB4 in the shift register. [Table 5](#) and [Table 6](#) show the different power-down options. For more information on how to set the DAC operating mode see [Table 17](#).

**Table 5. DAC-n Operating Modes**

DB5	DB4	DAC MODES OF OPERATION
0	0	Selected DACs power up (normal mode, default)
0	1	Selected DACs power down, output 1 kΩ to GND
1	0	Selected DACs power down, output 100 kΩ to GND
1	1	Selected DACs power down, output Hi-Z to GND

**Table 6. DAC-n Selection for Operating Modes**

DAC-B (DB1), DAC-A (DB0)	OPERATING MODE
0	DAC-n does not change operating mode
1	DAC-n operating mode set to value on PD1 and PD0

It is possible to write to the DAC register or buffer of the DAC channel that is powered down. When the DAC channel is then powered up, it powers up to this new value.

The advantage of the available power-down modes is that the output impedance of the device is known while it is in power-down mode. As described in [Table 5](#), there are three different power-down options.  $V_{OUT}$  can be connected internally to GND through a 1-kΩ resistor, a 100-kΩ resistor, or open-circuited (Hi-Z). The DAC power-down circuitry is shown in [Figure 92](#).

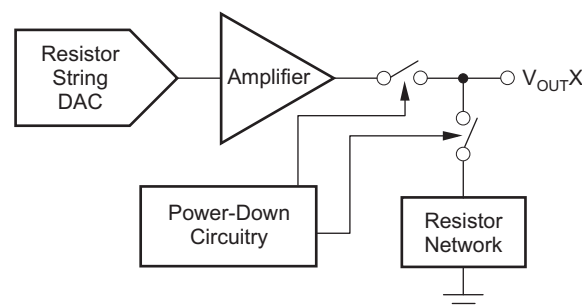

**Figure 92. Output Stage**

### 8.4.2 Gain Function

The gain register controls the GAIN setting in the DAC transfer function:

$$V_{OUT} = \left( \frac{D_{IN}}{2^n} \right) \times V_{REF} \times \text{Gain} \quad (2)$$

The DAC756x-Q1, DAC816x-Q1, and DAC856x-Q1 devices have a gain register for each channel. The gain for each channel, in [Equation 2](#), is either 1 or 2. This gain is automatically set to 2 when using the internal reference, and is automatically set to 1 when the internal reference is disabled (default). However, each channel can have either gain by setting the registers appropriately. The gain registers are accessible by setting the serial interface command bits to 000, address bits to 010, and using DB1 for DAC-B and DB0 for DAC-A. See [Table 7](#) and [Table 17](#) for the full command structure. The gain registers are automatically reset to provide either gain of 1 or 2 when the internal reference is powered off or on, respectively. After the reference is powered off or on, the gain register is again accessible to change the gain.

**Table 7. DAC-n Selection for Gain Register Command**

DB1, DB0	VALUE	GAIN
DB0	0	DAC-A uses gain = 2 (default with internal reference)
	1	DAC-A uses gain = 1 (default with external reference)
DB1	0	DAC-B uses gain = 2 (default with internal reference)
	1	DAC-B uses gain = 1 (default with external reference)

### 8.4.3 Software Reset Function

The DAC756x-Q1, DAC816x-Q1, and DAC856x-Q1 devices contain a software reset feature. The software reset function is accessed by setting the serial interface command bits to 101. The software reset command contains two reset modes which are software-programmable by setting bit DB0 in the shift register. [Table 8](#) and [Table 17](#) show the available software reset commands.

**Table 8. Software Reset**

DB0	REGISTERS RESET TO DEFAULT VALUES
0	DAC registers Input registers
1	DAC registers Input registers LDAC registers Power-down registers Internal reference register Gain registers

#### 8.4.4 Internal Reference Enable Register

The internal reference in the DAC756x-Q1, DAC816x-Q1, and DAC856x-Q1 devices is disabled by default for debugging, evaluation purposes, or when using an external reference. The internal reference can be powered up and powered down by setting the serial interface command bits to 111 and configuring DB0 (see [Table 9](#)). The internal reference is forced to a powered down state while both DAC channels are powered down, and can only be enabled if any DAC channel is in normal mode of operation. During the time that the internal reference is disabled, the DAC functions normally using an external reference. At this point, the internal reference is disconnected from the  $V_{REFIN}/V_{REFOUT}$  pin (Hi-Z output).

**Table 9. Internal Reference**

DB0	INTERNAL REFERENCE CONFIGURATION
0	Disable internal reference and reset DACs to gain = 1
1	Enable internal reference and reset DACs to gain = 2

##### 8.4.4.1 Enabling Internal Reference

To enable the internal reference, refer to the command structure in [Table 17](#). When performing a power cycle to reset the device, the internal reference is switched off (default mode). In the default mode, the internal reference is powered down until a valid write sequence powers up the internal reference. However, the internal reference is forced to a disabled state while both DAC channels are powered down, and remains disabled until either DAC channel is returned to the normal mode of operation. See [DAC Power-Down Commands](#) for more information on DAC channel modes of operation.

##### 8.4.4.2 Disabling Internal Reference

To disable the internal reference, refer to the command structure in [Table 17](#). When performing a power cycle to reset the device, the internal reference is disabled (default mode).

#### 8.4.5 CLR Functionality

The edge-triggered  $\overline{\text{CLR}}$  pin can be used to set the input and DAC registers immediately according to [Table 10](#). When the  $\overline{\text{CLR}}$  pin receives a falling edge signal the clear mode is activated and changes the DAC output voltages accordingly. The device exits clear mode on the 24<sup>th</sup> falling edge of the next write to the device. If the  $\overline{\text{CLR}}$  pin receives a falling edge signal during a write sequence in normal operation, the clear mode is activated and changes the input and DAC registers immediately according to [Table 10](#).

**Table 10. Clear Mode Reset Values**

DEVICE	DAC OUTPUT ENTERING CLEAR MODE
DAC8562-Q1, DAC8162-Q1, DAC7562-Q1	Zero-scale
DAC8563-Q1, DAC8163-Q1, DAC7563-Q1	Mid-scale

### 8.4.6 LDAC Functionality

The DAC756x-Q1, DAC816x-Q1, and DAC856x-Q1 devices offer both a software and hardware simultaneous update and control function. The DAC double-buffered architecture has been designed so that new data can be entered for each DAC without disturbing the analog outputs.

DAC756x-Q1, DAC816x-Q1, and DAC856x-Q1 data updates can be performed either in *synchronous* or in *asynchronous* mode.

In *asynchronous* mode, the  $\overline{\text{LDAC}}$  pin is used as a negative edge-triggered timing signal for simultaneous DAC updates. Multiple single-channel writes can be done in order to set different channel buffers to desired values and then make a falling edge on  $\overline{\text{LDAC}}$  pin to simultaneously update the DAC output registers. Data buffers of all channels must be loaded with desired data before an  $\overline{\text{LDAC}}$  falling edge. After a high-to-low  $\overline{\text{LDAC}}$  transition, all DACs are simultaneously updated with the last contents of the corresponding data buffers. If the content of a data buffer is not changed, the corresponding DAC output remains unchanged after the  $\overline{\text{LDAC}}$  pin is triggered.  $\overline{\text{LDAC}}$  must be returned high before the next serial command is initiated.

In *synchronous* mode, data are updated with the falling edge of the 24<sup>th</sup> SCLK cycle, which follows a falling edge of SYNC. For such *synchronous* updates, the  $\overline{\text{LDAC}}$  pin is not required, and it must be connected to GND permanently or asserted and held low before sending commands to the device.

Alternatively, all DAC outputs can be updated simultaneously using the built-in software function of LDAC. The LDAC register offers additional flexibility and control by allowing the selection of which DAC channel(s) should be updated simultaneously when the  $\overline{\text{LDAC}}$  pin is being brought low. The LDAC register is loaded with a 2-bit word (DB1 and DB0) using command bits C2, C1, and C0 (see [Table 17](#)). The default value for each bit, and therefore for each DAC channel, is zero. If the LDAC register bit is set to 1, it overrides the  $\overline{\text{LDAC}}$  pin (the  $\overline{\text{LDAC}}$  pin is internally tied low for that particular DAC channel) and this DAC channel updates synchronously after the falling edge of the 24<sup>th</sup> SCLK cycle. However, if the LDAC register bit is set to 0, the DAC channel is controlled by the  $\overline{\text{LDAC}}$  pin.

The combination of software and hardware simultaneous update functions is particularly useful in applications when updating a DAC channel, while keeping the other channel unaffected; see [Table 11](#) and [Table 17](#) for more information.

**Table 11. DAC-n Selection for LDAC Register Command**

DB1, DB0	VALUE	$\overline{\text{LDAC}}$ PIN FUNCTIONALITY
DB0	0	DAC-A uses $\overline{\text{LDAC}}$ pin
	1	DAC-A operates in synchronous mode
DB1	0	DAC-B uses $\overline{\text{LDAC}}$ pin
	1	DAC-B operates in synchronous mode

## 8.5 Programming

The DAC756x-Q1, DAC816x-Q1, and DAC856x-Q1 devices have a three-wire serial interface ( $\overline{\text{SYNC}}$ , SCLK, and  $\text{D}_{\text{IN}}$ ; see the table) compatible with SPI, QSPI, and Microwire interface standards, as well as most DSPs. See the Serial Write Operation timing diagram (Figure 1) for an example of a typical write sequence.

The DAC756x-Q1, DAC816x-Q1, or DAC856x-Q1 input shift register is 24 bits wide, consisting of two *don't care* bits (DB23 to DB22), three command bits (DB21 to DB19), three address bits (DB18 to DB16), and 16 data bits (DB15 to DB0). All 24 bits of data are loaded into the DAC under the control of the serial clock input, SCLK. DB23 (MSB) is the first bit that is loaded into the DAC shift register. DB23 is followed by the rest of the 24-bit word pattern, left-aligned. This configuration means that the first 24 bits of data are latched into the shift register, and any further clocking of data is ignored.

The write sequence begins by bringing the  $\overline{\text{SYNC}}$  line low. Data from the  $\text{D}_{\text{IN}}$  line are clocked into the 24-bit shift register on each falling edge of SCLK. The serial clock frequency can be as high as 50 MHz, making the DAC756x-Q1, DAC816x-Q1, and DAC856x-Q1 devices compatible with high-speed DSPs. On the 24<sup>th</sup> falling edge of the serial clock, the last data bit is clocked into the shift register and the shift register locks. Further clocking does not change the shift register data.

After receiving the 24<sup>th</sup> falling clock edge, the DAC756x-Q1, DAC816x-Q1, and DAC856x-Q1 devices decode the three command bits, three address bits and 16 data bits to perform the required function, without waiting for a  $\overline{\text{SYNC}}$  rising edge. After the 24<sup>th</sup> falling edge of SCLK is received, the  $\overline{\text{SYNC}}$  line may be kept low or brought high. In either case, the minimum delay time from the 24<sup>th</sup> falling SCLK edge to the next falling  $\overline{\text{SYNC}}$  edge must be met in order to begin the next cycle properly; see the Serial Write Operation timing diagram (Figure 1).

A rising edge of  $\overline{\text{SYNC}}$  before the 24-bit sequence is complete resets the SPI interface; no data transfer occurs. A new write sequence starts at the next falling edge of  $\overline{\text{SYNC}}$ . To assure the lowest power consumption of the device, care should be taken that the levels are as close to each rail as possible.

### 8.5.1 $\overline{\text{SYNC}}$ Interrupt

In a normal write sequence, the  $\overline{\text{SYNC}}$  line stays low for at least 24 falling edges of SCLK and the addressed DAC register updates on the 24<sup>th</sup> falling edge. However, if  $\overline{\text{SYNC}}$  is brought high before the 23<sup>rd</sup> falling edge, it acts as an interrupt to the write sequence; the shift register resets and the write sequence is discarded. Neither an update of the data buffer contents, DAC register contents, nor a change in the operating mode occurs (as shown in Figure 93).

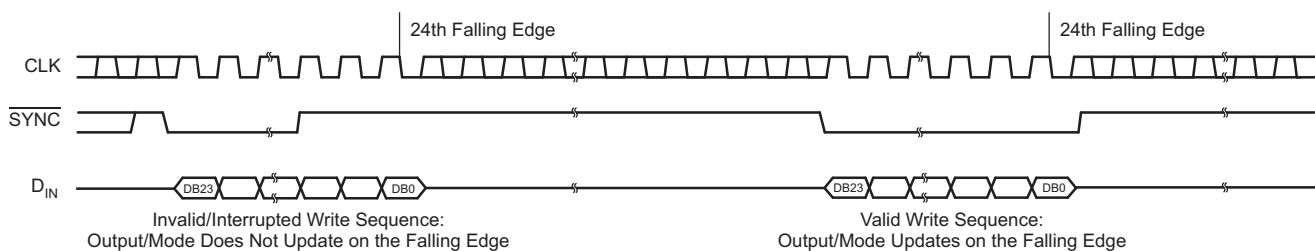

Figure 93.  $\overline{\text{SYNC}}$  Interrupt Facility

## Programming (continued)

### 8.5.2 DAC Register Configuration

When the DAC registers are being written to, the DAC756x-Q1, DAC816x-Q1, and DAC856x-Q1 devices receive all 24 bits of data, ignore DB23 and DB22, and decode the next three bits (DB21 to DB19) in order to determine the DAC operating or control mode (see [Table 12](#)). Bits DB18 to DB16 are used to address the DAC channels (see [Table 13](#)).

**Table 12. Commands for the DAC756x-Q1, DAC816x-Q1, and DAC856x-Q1 Devices**

C2 (DB21)	C1 (DB20)	C0 (DB19)	COMMAND
0	0	0	Write to input register n ( <a href="#">Table 13</a> )
0	0	1	Software LDAC, update DAC register n ( <a href="#">Table 13</a> )
0	1	0	Write to input register n ( <a href="#">Table 13</a> ) and update all DAC registers
0	1	1	Write to input register n and update DAC register n ( <a href="#">Table 13</a> )
1	0	0	Set DAC power-up or -down mode
1	0	1	Software reset
1	1	0	Set LDAC registers
1	1	1	Enable or disable the internal reference

**Table 13. Address Select for the DAC756x-Q1, DAC816x-Q1, and DAC856x-Q1 Devices**

A2 (DB18)	A1 (DB17)	A0 (DB16)	CHANNEL (n)
0	0	0	DAC-A
0	0	1	DAC-B
0	1	0	Gain (only use with command 000)
0	1	1	Reserved
1	0	0	Reserved
1	0	1	Reserved
1	1	0	Reserved
1	1	1	DAC-A and DAC-B

When writing to the DAC input registers the next 16, 14, or 12 bits of data that follow are decoded by the DAC to determine the equivalent analog output (see [Table 14](#) through [Table 16](#)). The data format is straight binary, with all 0s corresponding to 0-V output and all 1s corresponding to full-scale output. For all documentation purposes, the data format and representation used here is a true 16-bit pattern (that is, FFFFh data word for full scale) that the DAC756x-Q1, DAC816x-Q1, and DAC856x-Q1 devices require.

**Table 14. DAC856x-Q1 Data Input Register Format**

		COMMAND			ADDRESS			DATA																																					
X <sup>(1)</sup>	X	C2	C1	C0	A2	A1	A0	D15	D14	D13	D12	D11	D10	D9	D8	D7	D6	D5	D4	D3	D2	D1	D0																						
DB23																							DB0																						

(1) X denotes *don't care* bits.

**Table 15. DAC816x-Q1 Data Input Register Format**

		COMMAND			ADDRESS			DATA																																					
X	X	C2	C1	C0	A2	A1	A0	D13	D12	D11	D10	D9	D8	D7	D6	D5	D4	D3	D2	D1	D0	X	X																						
DB23																							DB0																						

**Table 16. DAC756x-Q1 Data Input Register Format**

		COMMAND			ADDRESS			DATA																
X	X	C2	C1	C0	A2	A1	A0	D11	D10	D9	D8	D7	D6	D5	D4	D3	D2	D1	D0	X	X	X	X	
DB23																				DB0				

In addition to DAC input register updates, the DAC756x-Q1, DAC816x-Q1, and DAC856x-Q1 devices support a number of functional mode commands (such as write to LDAC register, power down DACs and so on). The complete set of functional mode commands is shown in [Table 17](#).

**Table 17. Command Matrix for the DAC756x-Q1, DAC816x-Q1, and DAC856x-Q1 Devices**

DB23-DB22	COMMAND			ADDRESS			DATA						DESCRIPTION		
	C2	C1	C0	A2	A1	A0	DB15-DB6	DB5	DB4	DB3-DB2	DB1	DB0			
X <sup>(1)</sup>	0	0	0	0	0	0	16-, 14-, or 12-bit DAC data						Write to DAC-A input register		
				0	0	1	16-, 14-, or 12-bit DAC data						Write to DAC-B input register		
				1	1	1	16-, 14-, or 12-bit DAC data						Write to DAC-A and DAC-B input registers		
X	0	1	0	0	0	0	16-, 14-, or 12-bit DAC data						Write to DAC-A input register and update all DACs		
				0	0	1	16-, 14-, or 12-bit DAC data						Write to DAC-B input register and update all DACs		
				1	1	1	16-, 14-, or 12-bit DAC data						Write to DAC-A and DAC-B input register and update all DACs		
X	0	1	1	0	0	0	16-, 14-, or 12-bit DAC data						Write to DAC-A input register and update DAC-A		
				0	0	1	16-, 14-, or 12-bit DAC data						Write to DAC-B input register and update DAC-B		
				1	1	1	16-, 14-, or 12-bit DAC data						Write to DAC-A and DAC-B input register and update all DACs		
X	0	0	1	0	0	0	X						Update DAC-A		
				0	0	1	X						Update DAC-B		
				1	1	1	X						Update all DACs		
X	0	0	0	0	1	0	X						0	0	Gain: DAC-B gain = 2, DAC-A gain = 2 (default with internal V <sub>REF</sub> )
													0	1	Gain: DAC-B gain = 2, DAC-A gain = 1
													1	0	Gain: DAC-B gain = 1, DAC-A gain = 2
													1	1	Gain: DAC-B gain = 1, DAC-A gain = 1 (power-on default)
X	1	0	0	X			X	0	0	X	0	1	Power up DAC-A		
											1	0	Power up DAC-B		
											1	1	Power up DAC-A and DAC-B		
X	1	0	0	X			X	0	1	X	0	1	Power down DAC-A; 1 kΩ to GND		
											1	0	Power down DAC-B; 1 kΩ to GND		
											1	1	Power down DAC-A and DAC-B; 1 kΩ to GND		
X	1	0	0	X			X	1	0	X	0	1	Power down DAC-A; 100 kΩ to GND		
											1	0	Power down DAC-B; 100 kΩ to GND		
											1	1	Power down DAC-A and DAC-B; 100 kΩ to GND		
X	1	0	0	X			X	1	1	X	0	1	Power down DAC-A; Hi-Z		
											1	0	Power down DAC-B; Hi-Z		
											1	1	Power down DAC-A and DAC-B; Hi-Z		
X	1	0	1	X			X						X	0	Reset DAC-A and DAC-B input register and update all DACs
													X	1	Reset all registers and update all DACs (Power-on-reset update)
X	1	1	0	X			X						0	0	$\overline{\text{LDAC}}$ pin active for DAC-B and DAC-A
													0	1	$\overline{\text{LDAC}}$ pin active for DAC-B; inactive for DAC-A
													1	0	$\overline{\text{LDAC}}$ pin inactive for DAC-B; active for DAC-A
													1	1	$\overline{\text{LDAC}}$ pin inactive for DAC-B and DAC-A
X	1	1	1	X			X						X	0	Disable internal reference and reset DACs to gain = 1
													X	1	Enable internal reference and reset DACs to gain = 2

(1) X denotes *don't care* bits.



## 9 Application and Implementation

### NOTE

Information in the following applications sections is not part of the TI component specification, and TI does not warrant its accuracy or completeness. TI's customers are responsible for determining suitability of components for their purposes. Customers should validate and test their design implementation to confirm system functionality.

### 9.1 Application Information

#### 9.1.1 DAC Internal Reference

The internal reference of the DAC756x-Q1, DAC816x-Q1, and DAC856x-Q1 devices does not require an external load capacitor for stability because it is stable without any capacitive load. However, for improved noise performance, an external load capacitor of 150 nF or larger connected to the  $V_{REFIN}/V_{REFOUT}$  output is recommended. Figure 94 shows the typical connections required for operation of the DAC756x-Q1, DAC816x-Q1, and DAC856x-Q1 internal reference. A supply bypass capacitor at the  $AV_{DD}$  input is also recommended.

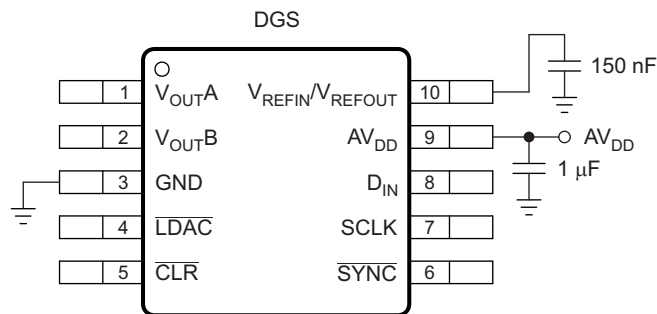

Figure 94. Typical Connection for Operating the DAC756x-Q1, DAC816x-Q1, and DAC856x-Q1 Internal Reference

##### 9.1.1.1 Supply Voltage

The internal reference features an extremely low dropout voltage. It can be operated with a supply of only 5 mV above the reference output voltage in an unloaded condition. For loaded conditions, see the [Load Regulation](#) section. The stability of the internal reference with variations in supply voltage (line regulation, dc PSRR) is also exceptional. Within the specified supply voltage range of 2.7 V to 5.5 V, the variation at  $V_{REFIN}/V_{REFOUT}$  is typically 50  $\mu\text{V/V}$ ; see [Figure 7](#).

##### 9.1.1.2 Temperature Drift

The internal reference is designed to exhibit minimal drift error, defined as the change in reference output voltage over varying temperature. The drift is calculated using the box method described by [Equation 3](#):

$$\text{Drift Error} = \left( \frac{V_{REF\_MAX} - V_{REF\_MIN}}{V_{REF} \times T_{RANGE}} \right) \times 10^6 \text{ (ppm/}^\circ\text{C)} \quad (3)$$

where:

$V_{REF\_MAX}$  = maximum reference voltage observed within temperature range  $T_{RANGE}$ .

$V_{REF\_MIN}$  = minimum reference voltage observed within temperature range  $T_{RANGE}$ .

$V_{REF}$  = 2.5 V, target value for reference output voltage.

$T_{RANGE}$  = the characterized range from  $-40^\circ\text{C}$  to  $125^\circ\text{C}$  (165 $^\circ\text{C}$  range)

The internal reference features an exceptional typical drift coefficient of 4 ppm/ $^\circ\text{C}$  from  $-40^\circ\text{C}$  to  $125^\circ\text{C}$ . Characterizing a large number of units, a maximum drift coefficient of 10 ppm/ $^\circ\text{C}$  is observed. Temperature drift results are summarized in [Figure 3](#).

## Application Information (continued)

### 9.1.1.3 Noise Performance

Typical 0.1-Hz to 10-Hz voltage noise and noise spectral density performance are listed in the [Electrical Characteristics](#). Additional filtering can be used to improve output noise levels, although care should be taken to ensure the output impedance does not degrade the ac performance. The output noise spectrum at the  $V_{REFIN}/V_{REFOUT}$  pin, both unloaded and with an external 4.7- $\mu$ F load capacitor, is shown in [Figure 6](#). Internal reference noise impacts the DAC output noise when the internal reference is used.

### 9.1.1.4 Load Regulation

Load regulation is defined as the change in reference output voltage as a result of changes in load current. The load regulation of the internal reference is measured using force and sense contacts as shown in [Figure 95](#). The force and sense lines reduce the impact of contact and trace resistance, resulting in accurate measurement of the load regulation contributed solely by the internal reference. Measurement results are shown in [Figure 4](#). Force and sense lines should be used for applications that require improved load regulation.

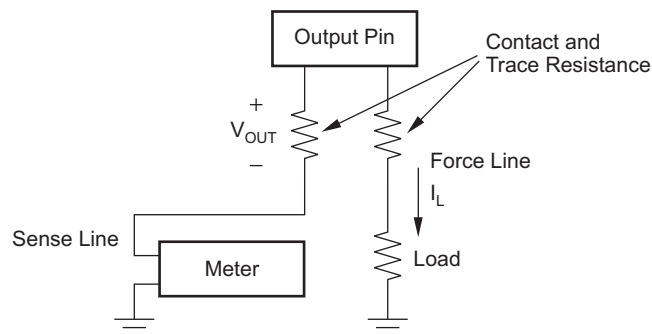

**Figure 95. Accurate Load Regulation of the DAC756x-Q1, DAC816x-Q1, and DAC856x-Q1 Internal Reference**

#### 9.1.1.4.1 Long-Term Stability

Long-term stability or aging refers to the change of the output voltage of a reference over a period of months or years. This effect lessens as time progresses. The typical drift value for the internal reference is listed in the [Electrical Characteristics](#) and measurement results are shown in [Figure 5](#). This parameter is characterized by powering up multiple devices and measuring them at regular intervals.

#### 9.1.1.5 Thermal Hysteresis

Thermal hysteresis for a reference is defined as the change in output voltage after operating the device at 25°C, cycling the device through the operating temperature range, and returning to 25°C. Hysteresis is expressed by [Equation 4](#):

$$V_{HYST} = \left[ \frac{V_{REF\_PRE} - V_{REF\_POST}}{V_{REF\_NOM}} \right] \times 10^6 (\text{ppm}/^\circ\text{C}) \quad (4)$$

where:

$V_{HYST}$  = thermal hysteresis.

$V_{REF\_PRE}$  = output voltage measured at 25°C pre-temperature cycling.

$V_{REF\_POST}$  = output voltage measured after the device cycles through the temperature range of –40°C to 125°C, and returns to 25°C.

$V_{REF\_NOM}$  = 2.5 V, target value for reference output voltage.

## 9.1.2 DAC Noise Performance

Output noise spectral density at the  $V_{OUT-n}$  pin versus frequency is depicted in [Figure 45](#) and [Figure 46](#) for full-scale, mid-scale, and zero-scale input codes. The typical noise density for mid-scale code is 90 nV/ $\sqrt{\text{Hz}}$  at 1 kHz. High-frequency noise can be improved by filtering the reference noise. Integrated output noise between 0.1 Hz and 10 Hz is close to 2.5  $\mu$ V<sub>PP</sub> (mid-scale), as shown in [Figure 47](#).

## 9.2 Typical Applications

### 9.2.1 Combined Voltage and Current Analog Output Module Using the XTR300

The design features two independent outputs that can source and sink voltage and current over the standard industrial output ranges. The possible outputs of the design include:  $-24\text{ mA}$  to  $24\text{ mA}$ ,  $4\text{ mA}$ – $20\text{ mA}$ ,  $0\text{ mA}$  to  $24\text{ mA}$ ,  $0\text{ V}$  to  $5\text{ V}$ ,  $0\text{ V}$  to  $10\text{ V}$ ,  $-5\text{ V}$  to  $5\text{ V}$ , and  $-10\text{ V}$  to  $10\text{ V}$ .

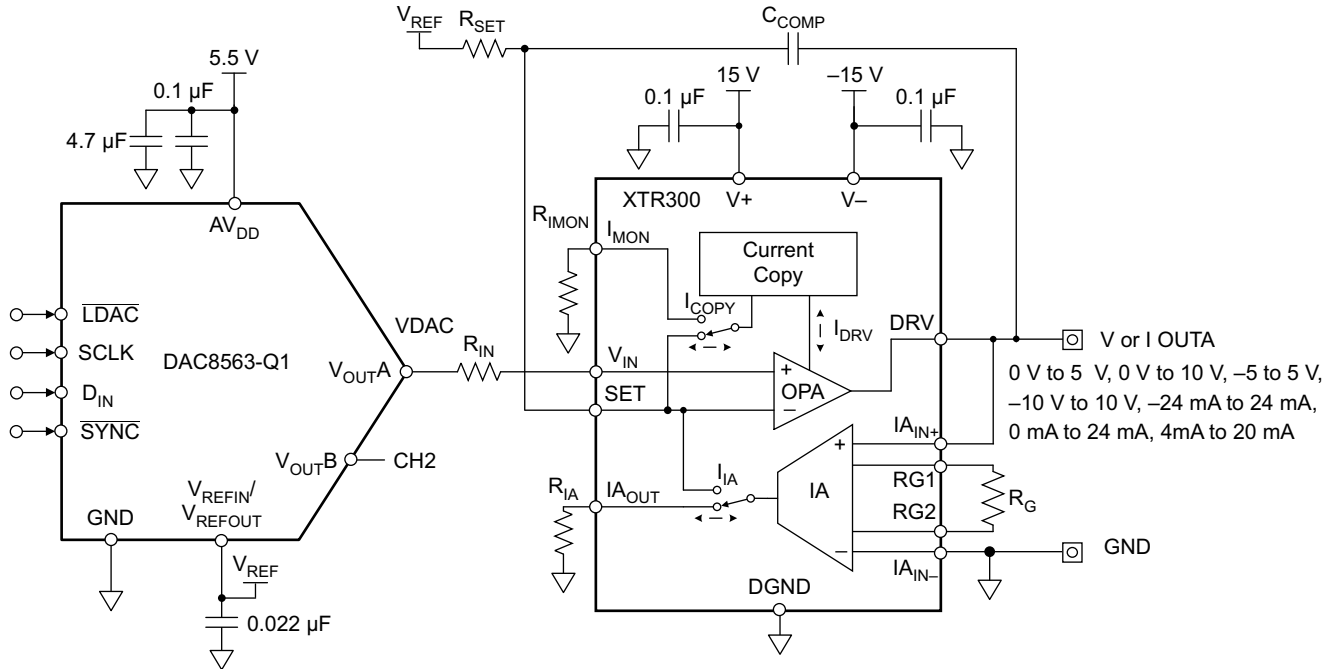

Figure 96. DAC8563-Q1 and XTR300 Discrete Analog Output Module

#### 9.2.1.1 Design Requirements

The design uses a DAC and a current-or-voltage output driver to create a discrete analog output design that can output either voltage or current from the same pin while focusing on high-accuracy specifications. The choice of the DAC8563-Q1 device takes advantage of its 16-bit resolution as well as its low typical offset error of  $1\text{ mV}$  and gain error of  $0.01\%$  FSR. The choice of the XTR300 device is based on its strong dc performance, having a typical error of  $400\text{ }\mu\text{V}$  and  $0.04\%$  FSR gain error. The XTR300 device allows a variety of both current and voltage outputs on the same pin while providing load monitoring and error status pins.

The power-on reset-to-midscale feature of the DAC8563-Q1 makes the bipolar output of the XTR300 power up at  $0\text{ V}$  or  $0\text{ A}$ . If using a unipolar output, the recommended device to achieve a system power-on output of  $0\text{ V}$ ,  $0\text{ A}$  or  $4\text{ mA}$  is the DAC8562-Q1 device.

A recommendation for minimizing the introduction of errors into the system is to use  $\pm 0.01\%$  tolerance  $R_G$  and  $R_{SET}$  resistors. The bypass capacitors on  $AV_{DD}$ ,  $V_{REF}$ ,  $V_+$  and  $V_-$  should have values between  $100\text{ nF}$  and  $10\text{ }\mu\text{F}$ . Smaller capacitors filter fast low-energy transients, whereas the large capacitors filter the slow high-energy transients. If there is an expectation of both types of signals in the system, the recommendation is to use a pair of small and large values as shown on the  $AV_{DD}$  pin of the DAC8563-Q1 device in Figure 96.

#### 9.2.1.2 Detailed Design Procedure

When configured for voltage mode, the output of the instrumentation amplifier (IA), internal to the XTR300 device, is routed to the SET pin. The SET output provides feedback for the IA based on the IA input voltage. The feedback from the IA provides high-impedance remote sensing of the voltage at the output load. Using the output voltage can overcome errors from PCB traces and protection component impedances. The DAC provides a unipolar input voltage to the  $V_{IN}$  pin of the XTR300 device. The XTR300 device offsets the  $V_{DAC}$  range by a negative  $V_{REF}$  and amplifies the difference by a value set by the  $R_G$  and  $R_{SET}$  resistors, as shown in Equation 5.

## Typical Applications (continued)

$$V_{OUT} = \frac{R_G}{2} \times \left( \frac{V_{DAC} - V_{REF}}{R_{SET}} \right) \quad (5)$$

When configured for current mode, the XTR300 routes the internal output of its current copy circuitry to the SET pin. This provides feedback for the internal OPA driver based on 1 / 10th of the output current, resulting in a voltage-to-current transfer function. Generating bipolar current outputs from the single-ended DAC output voltage,  $V_{DAC}$ , requires the application of an offset to the XTR300 SET pin. Connect the  $R_{SET}$  resistor from the SET pin to  $V_{REF}$  to apply the offset and obtain the transfer function shown in [Equation 6](#).

$$I_{OUT} = 10 \times \left( \frac{V_{DAC} - V_{REF}}{R_{SET}} \right) \quad (6)$$

The desired output ranges for  $V_{DAC}$  and  $V_{REF}$  voltages determine the  $R_{SET}$  and  $R_G$  resistor values, calculated using [Equation 7](#) and [Equation 8](#). The system design requires a  $V_{DAC}$  voltage range of 0.04 V to 4.96 V in order to operate the DAC8563-Q1 in the specified linear output range from codes 512 to 65 024.

$$R_{SET} = 10 \times \left( \frac{V_{DAC} - V_{REF}}{I_{OUT}} \right) = 10 \times \left( \frac{4.96 \text{ V} - 2.5 \text{ V}}{0.024 \text{ A}} \right) = 1025 \ \Omega \quad (7)$$

$$R_G = \frac{2 \times V_{OUT\_MAX} \times R_{SET}}{V_{DAC} - V_{REF}} = \frac{2 \times 10 \text{ V} \times 1020 \ \Omega}{4.96 \text{ V} - 2.5 \text{ V}} = 8292 \ \Omega \quad (8)$$

$I_{MON}$  and  $I_{A\_OUT}$  accomplish load monitoring. The sizing of  $R_{IMON}$  and  $R_{IA}$  determine the monitoring output voltage across the resistors. Size the resistors according to [Equation 9](#) and [Equation 10](#) and the expected output load current  $I_{DRV}$ .

$$R_{IMON} = \frac{10 \times V_{IMON}}{I_{DRV}} \quad (9)$$

$$R_{IA} = \frac{10 \times V_{IA}}{I_{IA}} \quad (10)$$

For more detailed information about the design procedure of this circuit and how to isolate it, see *Two-Channel Source/Sink Combined Voltage & Current Output, Isolated, EMC/EMI Tested Reference Design (TIDU434)*.

## Typical Applications (continued)

### 9.2.1.3 Application Curves

Figure 97 shows the transfer function for the bipolar  $\pm 10$  V voltage range. This design also supports output voltage ranges of 0–5 V, 0–10 V and  $\pm 5$  V. Figure 98 shows the transfer function for the unipolar 0–24 mA current range. This design also supports output current ranges of  $\pm 24$  mA and 4 mA–20 mA.

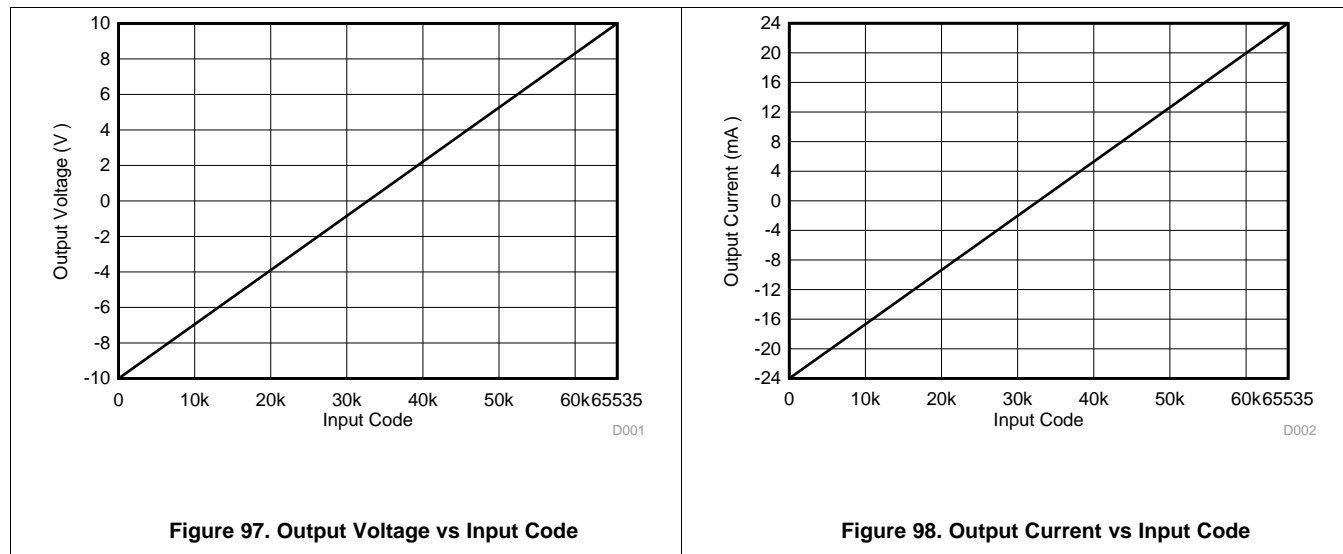

## Typical Applications (continued)

### 9.2.2 Up to ±15-V Bipolar Output Using the DAC8562-Q1

The DAC8562-Q1 is designed to be operate from a single power supply providing a maximum output range of  $AV_{DD}$  volts. However, the DAC can be placed in the configuration shown in Figure 99 in order to be designed into bipolar systems. Depending on the ratio of the resistor values, the output of the circuit can range anywhere from ±5 V to ±15 V. The design example below shows that the DAC is configured to have its internal reference enabled and the DAC8562-Q1 internal gain set to 2, however, an external 2.5-V reference could also be used (with DAC8562-Q1 internal gain set to 2).

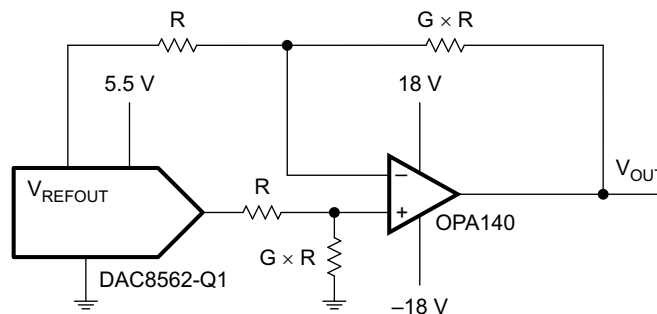

Figure 99. Bipolar Output Range Circuit Using DAC8562-Q1

The transfer function shown in Equation 5 can be used to calculate the output voltage as a function of the DAC code, reference voltage and resistor ratio:

$$V_{OUT} = G \times V_{REFOUT} \left( 2 \times \frac{D_{IN}}{65,536} - 1 \right) \quad (11)$$

where:

$D_{IN}$  = decimal equivalent of the binary code that is loaded to the DAC register, ranging from 0 to 65,535 for DAC8562-Q1 (16 bit).

$V_{REFOUT}$  = reference output voltage with the internal reference enabled from the DAC  $V_{REFIN}/V_{REFOUT}$  pin

$G$  = ratio of the resistors

An example configuration to generate a ±10-V output range is shown below in Equation 6 with  $G = 4$  and  $V_{REFOUT} = 2.5$  V:

$$V_{OUT} = 20 \times \frac{D_{IN}}{65,536} - 10 \text{ V} \quad (12)$$

In this example, the range is set to ±10 V by using a resistor ratio of four,  $V_{REFOUT}$  of 2.5 V, and DAC8562-Q1 internal gain of 2. The resistor sizes must be selected keeping in mind the current sink or source capability of the DAC8562-Q1 internal reference. Using larger resistor values, for example,  $R = 10$  kΩ or larger, is recommended. The op amp is selectable depending on the requirements of the system.

The DAC8562EVM and DAC7562EVM boards have the option to evaluate the bipolar output application by installing the components on the pre-placed footprints. For more information see either the [DAC8562EVM](#) or [DAC7562EVM](#) product folder.

## 9.3 System Examples

### 9.3.1 MSP430 Microprocessor Interfacing

Figure 100 shows a serial interface between the DAC756x-Q1, DAC816x-Q1, or DAC856x-Q1 device and a typical MSP430 USI port such as the one found on the MSP430F2013. The port is configured in SPI master mode by setting bits 3, 5, 6, and 7 in USICTL0. The USI counter interrupt is set in USICTL1 to provide an efficient means of SPI communication with minimal software overhead. The serial clock polarity, source, and speed are controlled by settings in the USI clock control register (USICKCTL). The SYNC signal is derived from a bit-programmable pin on port 1; in this case, port line P1.4 is used. When data are to be transmitted to the DAC756x-Q1, DAC816x-Q1, or DAC856x-Q1 device, P1.4 is taken low. The USI transmits data in 8-bit bytes; thus, only eight falling clock edges occur in the transmit cycle. To load data to the DAC, P1.4 is left low after the first eight bits are transmitted; then, a second write cycle is initiated to transmit the second byte of data. P1.4 is taken high following the completion of the third write cycle.

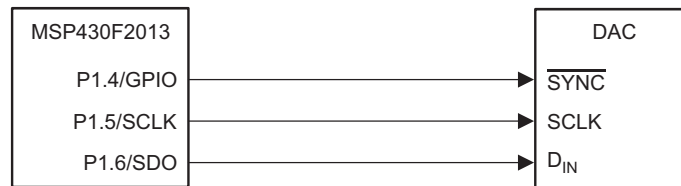

NOTE: Additional pins omitted for clarity.

Figure 100. DAC756x-Q1, DAC816x-Q1, or DAC856x-Q1 Device to MSP430 Interface

### 9.3.2 TMS320 McBSP Microprocessor Interfacing

Figure 101 shows an interface between the DAC756x-Q1, DAC816x-Q1, or DAC856x-Q1 device and any TMS320 series DSP from Texas Instruments with a multi-channel buffered serial port (McBSP). Serial data are shifted out on the rising edge of the serial clock and are clocked into the DAC756x-Q1, DAC816x-Q1, or DAC856x-Q1 device on the falling edge of the SCLK signal.

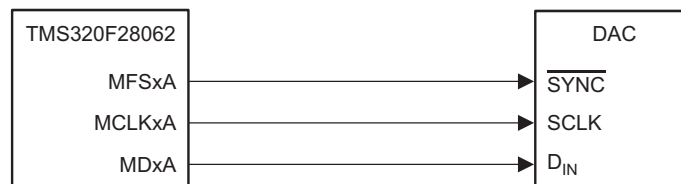

NOTE: Additional pins omitted for clarity.

Figure 101. DAC756x-Q1, DAC816x-Q1, or DAC856x-Q1 Device to TMS320 McBSP Interface

### 9.3.3 OMAP-L1x Processor Interfacing

Figure 102 shows a serial interface between the DAC756x-Q1, DAC816x-Q1, or DAC856x-Q1 device and the OMAP-L138 processor. The transmit clock CLKx0 of the L138 drives SCLK of the DAC756x-Q1, DAC816x-Q1, or DAC856x-Q1 device, and the data transmit (Dx0) output drives the serial data line of the DAC. The SYNC signal is derived from the frame sync transmit (FSx0) line, similar to the TMS320 interface.

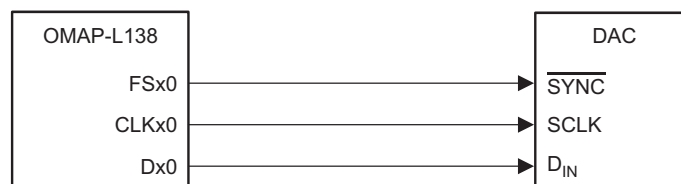

NOTE: Additional pins omitted for clarity.

Figure 102. DAC756x-Q1, DAC816x-Q1, or DAC856x-Q1 Device to OMAP-L1x Processor



## 10 Power Supply Recommendations

These devices can operate within the specified supply voltage range of 2.7 V to 5.5 V. The power applied to  $AV_{DD}$  should be well-regulated and low-noise. In order to further minimize noise from the power supplies, a strong recommendation is to include a pair of 100-pF and 1-nF capacitors and a 0.1- $\mu$ F to 1- $\mu$ F bypass capacitor. The current consumption of the  $AV_{DD}$  pin, the short-circuit current limit, and the load current for these devices are listed in the [Electrical Characteristics](#) table. Choose the power supplies for these devices to meet the aforementioned current requirements.

## 11 Layout

### 11.1 Layout Guidelines

A precision analog component requires careful layout, adequate bypassing, and clean, well-regulated power supplies. The DAC756x-Q1, DAC816x-Q1, and DAC856x-Q1 devices offer single-supply operation, and are often used in close proximity with digital logic, microcontrollers, microprocessors, and digital signal processors. The more digital logic present in the design and the higher the switching speed, the more difficult it is to keep digital noise from appearing at the output. As a result of the single ground pin of the DAC756x-Q1, DAC816x-Q1, and DAC856x-Q1 devices, all return currents (including digital and analog return currents for the DAC) must flow through a single point. Ideally, GND would be connected directly to an analog ground plane. This plane would be separate from the ground connection for the digital components until they were connected at the power-entry point of the system. The power applied to  $AV_{DD}$  should be well-regulated and low noise. Switching power supplies and dc-dc converters often have high-frequency glitches or spikes riding on the output voltage. In addition, digital components can create similar high-frequency spikes as their internal logic switches states. This noise can easily couple into the DAC output voltage through various paths between the power connections and analog output. As with the GND connection,  $AV_{DD}$  should be connected to a power-supply plane or trace that is separate from the connection for digital logic until they are connected at the power-entry point. In addition, a pair of 100-pF to 1-nF capacitors and a 0.1- $\mu$ F to 1- $\mu$ F bypass capacitor are strongly recommended. In some situations, additional bypassing may be required, such as a 100- $\mu$ F electrolytic capacitor or even a pi filter made up of inductors and capacitors – all designed essentially to provide low-pass filtering for the supply and remove the high-frequency noise.



## 11.2 Layout Example

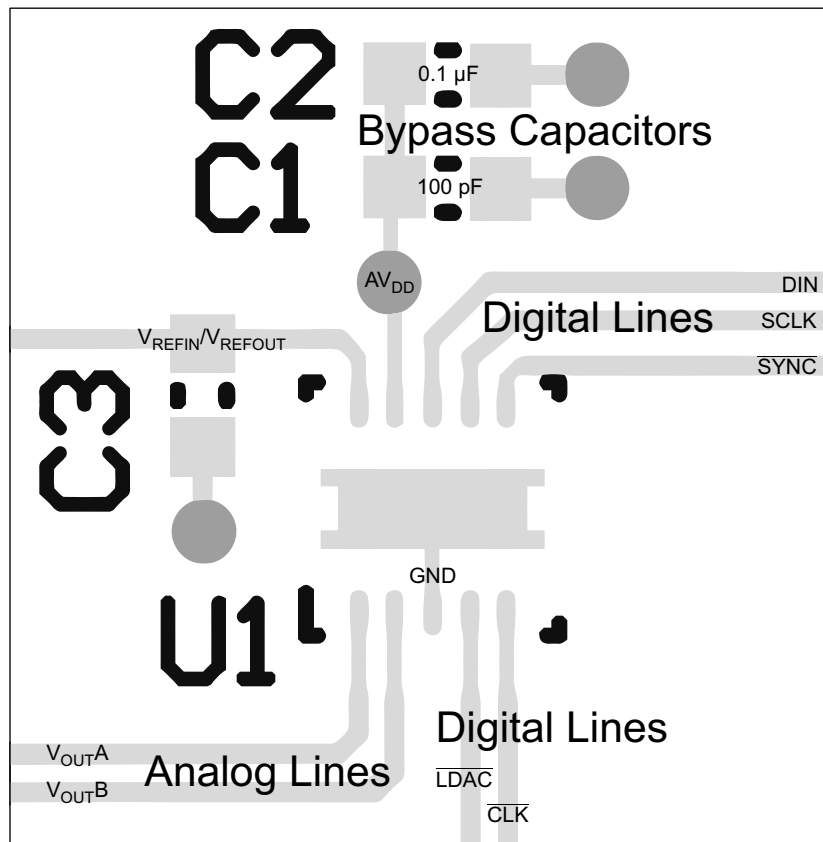

Figure 103. DACxx6x-Q1 Layout Example

## 12 Device and Documentation Support

### 12.1 Documentation Support

#### 12.1.1 Related Documentation

For related documentation see the following:

- *DAC7562EVM, DAC8562EVM* User's Guide ([SBAU183](#)) or go to either of the following tool folders:
  - [DAC8562EVM](#)
  - [DAC7562EVM](#)
- MSP430F2013, *MIXED SIGNAL MICROCONTROLLER* ([SLAS491](#))
- OMAP-L138 C6000™ DSP+ ARM® Processor ([SPRS586](#))
- TMS320F2806x *Piccolo™* Microcontrollers ([SPRS698](#))
- XTR111, *Precision Voltage-to-Current Converter/Transmitter* ([SBOS375](#))

#### 12.2 Related Links

The table below lists quick access links. Categories include technical documents, support and community resources, tools and software, and quick access to sample or buy.

Table 18. Related Links

PARTS	PRODUCT FOLDER	SAMPLE & BUY	TECHNICAL DOCUMENTS	TOOLS & SOFTWARE	SUPPORT & COMMUNITY
DAC8562-Q1	<a href="#">Click here</a>	<a href="#">Click here</a>	<a href="#">Click here</a>	<a href="#">Click here</a>	<a href="#">Click here</a>
DAC8563-Q1	<a href="#">Click here</a>	<a href="#">Click here</a>	<a href="#">Click here</a>	<a href="#">Click here</a>	<a href="#">Click here</a>
DAC8162-Q1	<a href="#">Click here</a>	<a href="#">Click here</a>	<a href="#">Click here</a>	<a href="#">Click here</a>	<a href="#">Click here</a>
DAC8163-Q1	<a href="#">Click here</a>	<a href="#">Click here</a>	<a href="#">Click here</a>	<a href="#">Click here</a>	<a href="#">Click here</a>
DAC7562-Q1	<a href="#">Click here</a>	<a href="#">Click here</a>	<a href="#">Click here</a>	<a href="#">Click here</a>	<a href="#">Click here</a>
DAC7563-Q1	<a href="#">Click here</a>	<a href="#">Click here</a>	<a href="#">Click here</a>	<a href="#">Click here</a>	<a href="#">Click here</a>

#### 12.3 Community Resource

The following links connect to TI community resources. Linked contents are provided "AS IS" by the respective contributors. They do not constitute TI specifications and do not necessarily reflect TI's views; see TI's [Terms of Use](#).

**TI E2E™ Online Community** *TI's Engineer-to-Engineer (E2E) Community*. Created to foster collaboration among engineers. At [e2e.ti.com](#), you can ask questions, share knowledge, explore ideas and help solve problems with fellow engineers.

**Design Support** *TI's Design Support* Quickly find helpful E2E forums along with design support tools and contact information for technical support.

#### 12.4 Trademarks

E2E is a trademark of Texas Instruments.  
 SPI, QSPI are trademarks of Motorola, Inc.  
 All other trademarks are the property of their respective owners.

#### 12.5 Electrostatic Discharge Caution



These devices have limited built-in ESD protection. The leads should be shorted together or the device placed in conductive foam during storage or handling to prevent electrostatic damage to the MOS gates.

#### 12.6 Glossary

[SLYZ022](#) — *TI Glossary*.

This glossary lists and explains terms, acronyms, and definitions.

## 13 Mechanical, Packaging, and Orderable Information

The following pages include mechanical, packaging, and orderable information. This information is the most current data available for the designated devices. This data is subject to change without notice and revision of this document. For browser-based versions of this data sheet, refer to the left-hand navigation.

**PACKAGING INFORMATION**

Orderable Device	Status (1)	Package Type	Package Drawing	Pins	Package Qty	Eco Plan (2)	Lead/Ball Finish (6)	MSL Peak Temp (3)	Op Temp (°C)	Device Marking (4/5)	Samples
DAC7562SQDGSRQ1	ACTIVE	VSSOP	DGS	10	2500	Green (RoHS & no Sb/Br)	CU NIPDAUAG	Level-2-260C-1 YEAR	-40 to 125	ZADV	<a href="#">Samples</a>
DAC7563SQDGSRQ1	ACTIVE	VSSOP	DGS	10	2500	Green (RoHS & no Sb/Br)	CU NIPDAUAG	Level-2-260C-1 YEAR	-40 to 125	ZAIV	<a href="#">Samples</a>
DAC8162SQDGSRQ1	ACTIVE	VSSOP	DGS	10	2500	Green (RoHS & no Sb/Br)	CU NIPDAUAG	Level-2-260C-1 YEAR	-40 to 125	ZAGV	<a href="#">Samples</a>
DAC8163SQDGSRQ1	ACTIVE	VSSOP	DGS	10	2500	Green (RoHS & no Sb/Br)	CU NIPDAUAG	Level-2-260C-1 YEAR	-40 to 125	ZAHV	<a href="#">Samples</a>
DAC8562SQDGSRQ1	ACTIVE	VSSOP	DGS	10	2500	Green (RoHS & no Sb/Br)	CU NIPDAUAG	Level-2-260C-1 YEAR	-40 to 125	ZAAQ	<a href="#">Samples</a>
DAC8563SQDGSRQ1	ACTIVE	VSSOP	DGS	10	2500	Green (RoHS & no Sb/Br)	CU NIPDAUAG	Level-2-260C-1 YEAR	-40 to 125	ZAJV	<a href="#">Samples</a>

(1) The marketing status values are defined as follows:

**ACTIVE:** Product device recommended for new designs.

**LIFEBUY:** TI has announced that the device will be discontinued, and a lifetime-buy period is in effect.

**NRND:** Not recommended for new designs. Device is in production to support existing customers, but TI does not recommend using this part in a new design.

**PREVIEW:** Device has been announced but is not in production. Samples may or may not be available.

**OBSELETE:** TI has discontinued the production of the device.

(2) Eco Plan - The planned eco-friendly classification: Pb-Free (RoHS), Pb-Free (RoHS Exempt), or Green (RoHS & no Sb/Br) - please check <http://www.ti.com/productcontent> for the latest availability information and additional product content details.

**TBD:** The Pb-Free/Green conversion plan has not been defined.

**Pb-Free (RoHS):** TI's terms "Lead-Free" or "Pb-Free" mean semiconductor products that are compatible with the current RoHS requirements for all 6 substances, including the requirement that lead not exceed 0.1% by weight in homogeneous materials. Where designed to be soldered at high temperatures, TI Pb-Free products are suitable for use in specified lead-free processes.

**Pb-Free (RoHS Exempt):** This component has a RoHS exemption for either 1) lead-based flip-chip solder bumps used between the die and package, or 2) lead-based die adhesive used between the die and leadframe. The component is otherwise considered Pb-Free (RoHS compatible) as defined above.

**Green (RoHS & no Sb/Br):** TI defines "Green" to mean Pb-Free (RoHS compatible), and free of Bromine (Br) and Antimony (Sb) based flame retardants (Br or Sb do not exceed 0.1% by weight in homogeneous material)

(3) MSL, Peak Temp. - The Moisture Sensitivity Level rating according to the JEDEC industry standard classifications, and peak solder temperature.

(4) There may be additional marking, which relates to the logo, the lot trace code information, or the environmental category on the device.

(5) Multiple Device Markings will be inside parentheses. Only one Device Marking contained in parentheses and separated by a "~" will appear on a device. If a line is indented then it is a continuation of the previous line and the two combined represent the entire Device Marking for that device.

<sup>(6)</sup> Lead/Ball Finish - Orderable Devices may have multiple material finish options. Finish options are separated by a vertical ruled line. Lead/Ball Finish values may wrap to two lines if the finish value exceeds the maximum column width.

**Important Information and Disclaimer:**The information provided on this page represents TI's knowledge and belief as of the date that it is provided. TI bases its knowledge and belief on information provided by third parties, and makes no representation or warranty as to the accuracy of such information. Efforts are underway to better integrate information from third parties. TI has taken and continues to take reasonable steps to provide representative and accurate information but may not have conducted destructive testing or chemical analysis on incoming materials and chemicals. TI and TI suppliers consider certain information to be proprietary, and thus CAS numbers and other limited information may not be available for release.

In no event shall TI's liability arising out of such information exceed the total purchase price of the TI part(s) at issue in this document sold by TI to Customer on an annual basis.

**OTHER QUALIFIED VERSIONS OF DAC7562-Q1, DAC7563-Q1, DAC8162-Q1, DAC8163-Q1, DAC8562-Q1, DAC8563-Q1 :**

- Catalog: [DAC7562](#), [DAC7563](#), [DAC8162](#), [DAC8163](#), [DAC8562](#), [DAC8563](#)

NOTE: Qualified Version Definitions:

- Catalog - TI's standard catalog product

## TAPE AND REEL INFORMATION



### QUADRANT ASSIGNMENTS FOR PIN 1 ORIENTATION IN TAPE



\*All dimensions are nominal

Device	Package Type	Package Drawing	Pins	SPQ	Reel Diameter (mm)	Reel Width W1 (mm)	A0 (mm)	B0 (mm)	K0 (mm)	P1 (mm)	W (mm)	Pin1 Quadrant
DAC7562SQDGSRQ1	VSSOP	DGS	10	2500	330.0	12.4	5.3	3.3	1.3	8.0	12.0	Q1
DAC7563SQDGSRQ1	VSSOP	DGS	10	2500	330.0	12.4	5.3	3.3	1.3	8.0	12.0	Q1
DAC8162SQDGSRQ1	VSSOP	DGS	10	2500	330.0	12.4	5.3	3.3	1.3	8.0	12.0	Q1
DAC8163SQDGSRQ1	VSSOP	DGS	10	2500	330.0	12.4	5.3	3.3	1.3	8.0	12.0	Q1
DAC8562SQDGSRQ1	VSSOP	DGS	10	2500	330.0	12.4	5.3	3.3	1.3	8.0	12.0	Q1
DAC8563SQDGSRQ1	VSSOP	DGS	10	2500	330.0	12.4	5.3	3.3	1.3	8.0	12.0	Q1

**TAPE AND REEL BOX DIMENSIONS**

\*All dimensions are nominal

Device	Package Type	Package Drawing	Pins	SPQ	Length (mm)	Width (mm)	Height (mm)
DAC7562SQDGSRQ1	VSSOP	DGS	10	2500	370.0	355.0	55.0
DAC7563SQDGSRQ1	VSSOP	DGS	10	2500	370.0	355.0	55.0
DAC8162SQDGSRQ1	VSSOP	DGS	10	2500	370.0	355.0	55.0
DAC8163SQDGSRQ1	VSSOP	DGS	10	2500	370.0	355.0	55.0
DAC8562SQDGSRQ1	VSSOP	DGS	10	2500	370.0	355.0	55.0
DAC8563SQDGSRQ1	VSSOP	DGS	10	2500	370.0	355.0	55.0

# DGS0010A



# PACKAGE OUTLINE

## VSSOP - 1.1 mm max height

SMALL OUTLINE PACKAGE



### NOTES:

1. All linear dimensions are in millimeters. Any dimensions in parenthesis are for reference only. Dimensioning and tolerancing per ASME Y14.5M.
2. This drawing is subject to change without notice.
3. This dimension does not include mold flash, protrusions, or gate burrs. Mold flash, protrusions, or gate burrs shall not exceed 0.15 mm per side.
4. This dimension does not include interlead flash. Interlead flash shall not exceed 0.25 mm per side.
5. Reference JEDEC registration MO-187, variation BA.



# EXAMPLE BOARD LAYOUT

DGS0010A

VSSOP - 1.1 mm max height

SMALL OUTLINE PACKAGE



LAND PATTERN EXAMPLE  
SCALE:10X



SOLDER MASK DETAILS  
NOT TO SCALE

4221984/A 05/2015

NOTES: (continued)

- 6. Publication IPC-7351 may have alternate designs.
- 7. Solder mask tolerances between and around signal pads can vary based on board fabrication site.

# EXAMPLE STENCIL DESIGN

DGS0010A

VSSOP - 1.1 mm max height

SMALL OUTLINE PACKAGE



SOLDER PASTE EXAMPLE  
BASED ON 0.125 mm THICK STENCIL  
SCALE:10X

4221984/A 05/2015

NOTES: (continued)

8. Laser cutting apertures with trapezoidal walls and rounded corners may offer better paste release. IPC-7525 may have alternate design recommendations.
9. Board assembly site may have different recommendations for stencil design.

## IMPORTANT NOTICE AND DISCLAIMER

TI PROVIDES TECHNICAL AND RELIABILITY DATA (INCLUDING DATASHEETS), DESIGN RESOURCES (INCLUDING REFERENCE DESIGNS), APPLICATION OR OTHER DESIGN ADVICE, WEB TOOLS, SAFETY INFORMATION, AND OTHER RESOURCES "AS IS" AND WITH ALL FAULTS, AND DISCLAIMS ALL WARRANTIES, EXPRESS AND IMPLIED, INCLUDING WITHOUT LIMITATION ANY IMPLIED WARRANTIES OF MERCHANTABILITY, FITNESS FOR A PARTICULAR PURPOSE OR NON-INFRINGEMENT OF THIRD PARTY INTELLECTUAL PROPERTY RIGHTS.

These resources are intended for skilled developers designing with TI products. You are solely responsible for (1) selecting the appropriate TI products for your application, (2) designing, validating and testing your application, and (3) ensuring your application meets applicable standards, and any other safety, security, or other requirements. These resources are subject to change without notice. TI grants you permission to use these resources only for development of an application that uses the TI products described in the resource. Other reproduction and display of these resources is prohibited. No license is granted to any other TI intellectual property right or to any third party intellectual property right. TI disclaims responsibility for, and you will fully indemnify TI and its representatives against, any claims, damages, costs, losses, and liabilities arising out of your use of these resources.

TI's products are provided subject to TI's Terms of Sale ([www.ti.com/legal/termsofsale.html](http://www.ti.com/legal/termsofsale.html)) or other applicable terms available either on [ti.com](http://ti.com) or provided in conjunction with such TI products. TI's provision of these resources does not expand or otherwise alter TI's applicable warranties or warranty disclaimers for TI products.

Mailing Address: Texas Instruments, Post Office Box 655303, Dallas, Texas 75265  
Copyright © 2019, Texas Instruments Incorporated