

SWITCHING DIODE

FEATURES:

- Four types of packaging are available
- High speed
- Suitable for high packing density layout
- High reliability
- **Pb-Free package is available**
RoHS product for packing code suffix "G"
Halogen free product for packing code suffix "H"
- **Moisture Sensitivity Level 1**

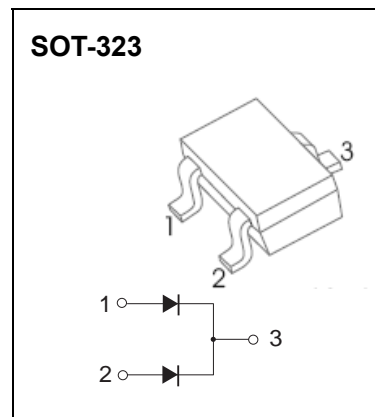

MARKING:N

Maximum Ratings and Electrical Characteristics, Single Diode @Ta=25 °C

Parameter	Symbol	Limit	Unit
Peak reverse voltage	V_{RM}	80	V
DC reverse voltage	V_R	80	V
Maximum (peak) forward current	I_{FM}	300	mA
Average forward current	I_O	100	mA
Power dissipation	P_D	200	mW
Junction temperature	T_j	150	°C
Storage temperature	T_{stg}	-55~+150	°C

ELECTRICAL CHARACTERISTICS (Ta=25°C unless otherwise specified)

Parameter	Symbol	Test conditions	Min	Max	Unit
Reverse breakdown voltage	$V_{(BR)}$	$I_R=100\mu A$	80		V
Reverse voltage leakage current	I_R	$V_R=70V$		0.1	μA
Forward voltage	V_F	$I_F=100mA$		1.2	V
Diode capacitance	C_D	$V_R=6V, f=1MHz$		3.5	pF
Reverse recovery time	t_{rr}	$V_R=6V, I_F=5mA$		4	ns



Typical Characteristics

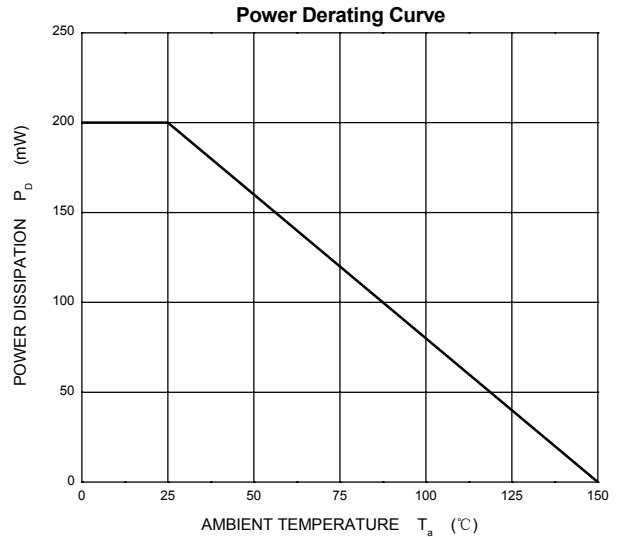
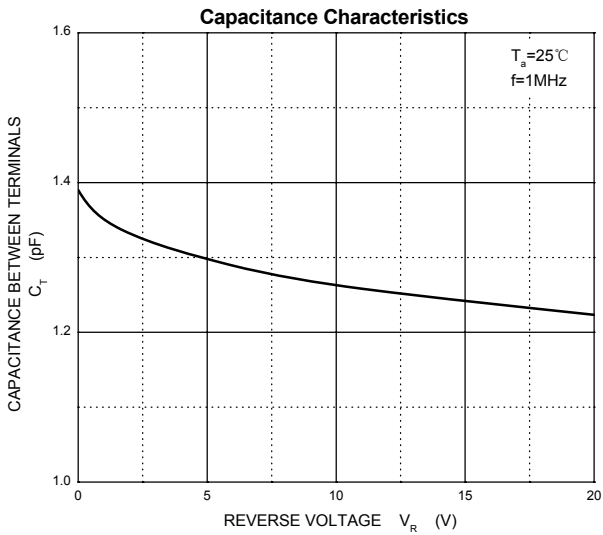
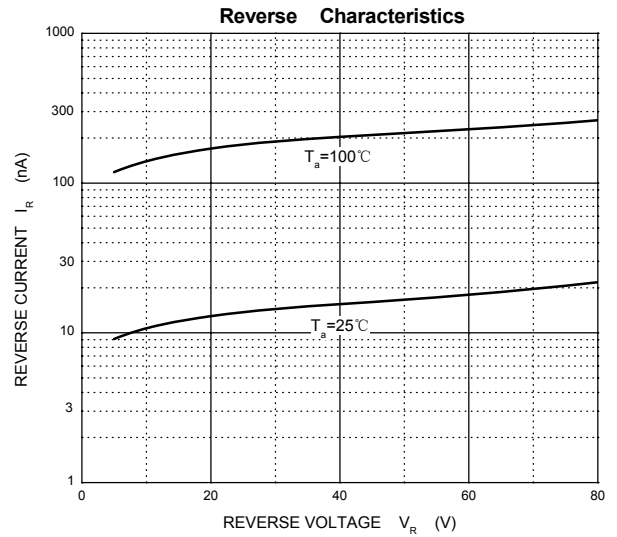
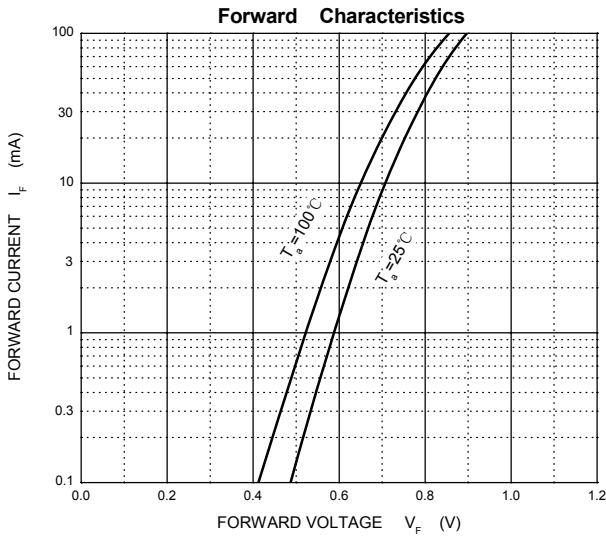



Outline Drawing

SOT-323

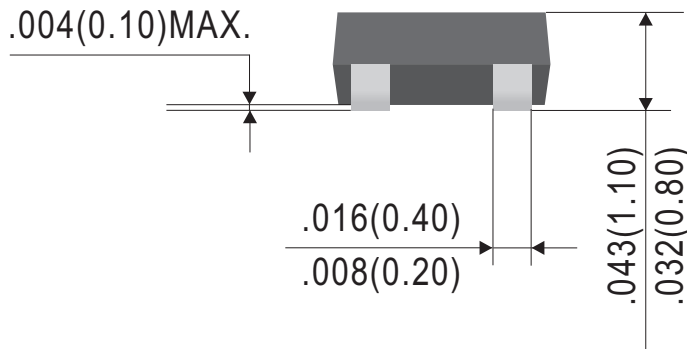
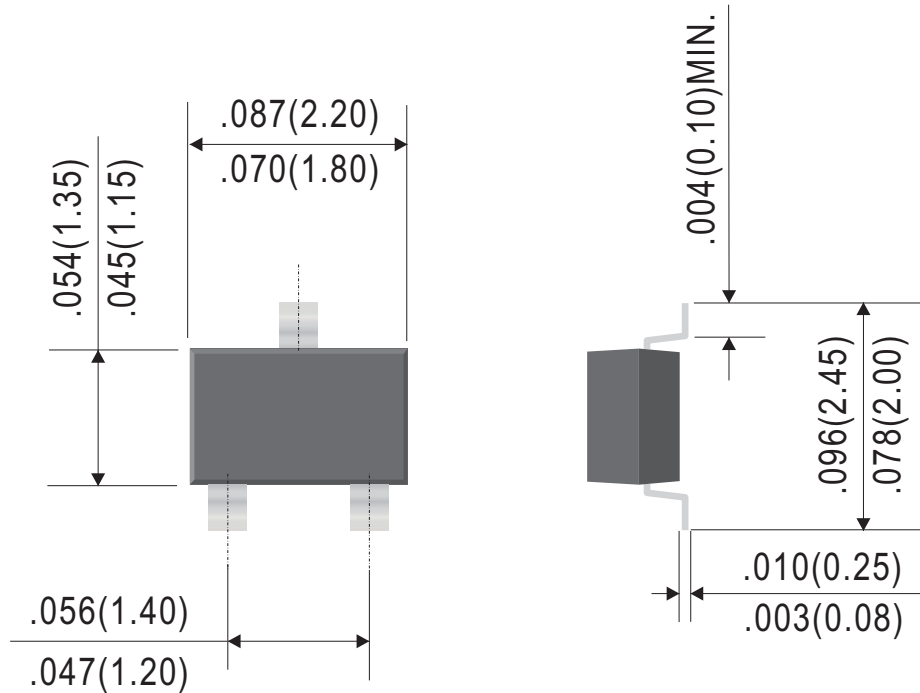

Dimensions in inches and (millimeters)