

Features

- Dual Diode Common Anode and Cathode
- Fast Switching
- Surface Mount Package Ideally Suited for Automatic Insertion
- For General Purpose Switching Applications
- Plastic Material – UL Recognition Flammability Classification 94V-0

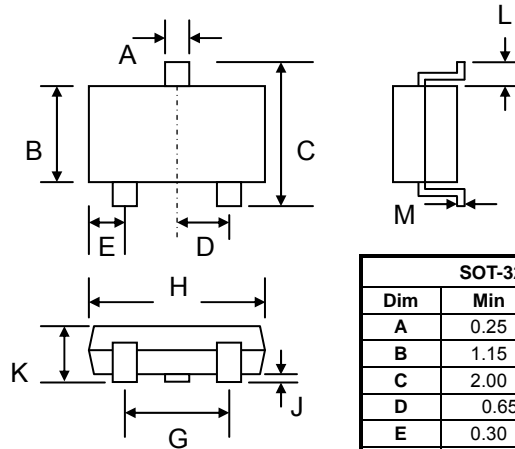

SOT-323		
Dim	Min	Max
A	0.25	0.40
B	1.15	1.35
C	2.00	2.40
D	0.65 Nominal	
E	0.30	0.40
G	1.20	1.40
H	1.80	2.20
J	—	0.10
K	0.90	1.10
L	0.25	—
M	0.05	0.15
All Dimensions in mm		

Mechanical Data

- Case: SOT-323, Molded Plastic
- Terminals: Plated Leads Solderable per MIL-STD-202, Method 208
- Polarity: See Diagrams Below
- Weight: 0.006 grams (approx.)
- Marking: Device Code, See Page 3
- Mounting Position: Any
- **Lead Free: For RoHS / Lead Free Version, Add "-LF" Suffix to Part Number, See Page 4**

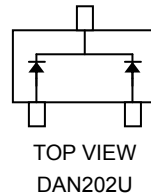
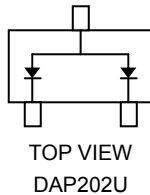

Maximum Ratings @ $T_A=25^\circ\text{C}$ unless otherwise specified

Characteristic	Symbol	Value	Unit
Peak Repetitive Reverse Voltage	VRRM	80	V
Working Peak Reverse Voltage DC Blocking Voltage	VRWM VR	80	V
Forward Continuous Current	IFM	300	mA
Average Rectified Output Current	IO	100	mA
Non-Repetitive Peak Forward Surge Current @ $t = 1.0\mu\text{s}$	IFSM	4.0	A
Operating and Storage Temperature Range	TJ, TSTG	-55 to +150	$^\circ\text{C}$

Thermal Characteristics

Characteristic	Symbol	Value	Unit
Power Dissipation (Note 1)	PD	200	mW

Note: 1. Mounted on FR-4 PC board with minimum recommended pad layout.

Electrical Characteristics @ $T_A=25^\circ\text{C}$ unless otherwise specified

Characteristic	Symbol	Min.	Typ.	Max.	Unit
Forward Voltage Drop @ $I_F = 100\text{mA}$	V_{FM}			1.2	V
Peak Reverse Leakage Current @ $V_R = 70\text{V}$	I_{RM}			100	nA
Diode Capacitance ($V_R = 6.0\text{V}$, $f = 1.0\text{MHz}$)	C_D			3.5	pF
Reverse Recovery Time ($I_F = I_R = 5.0\text{mA}$, $V_R = 6\text{V}$, $R_L = 50\Omega$)	t_{rr}			4.0	nS

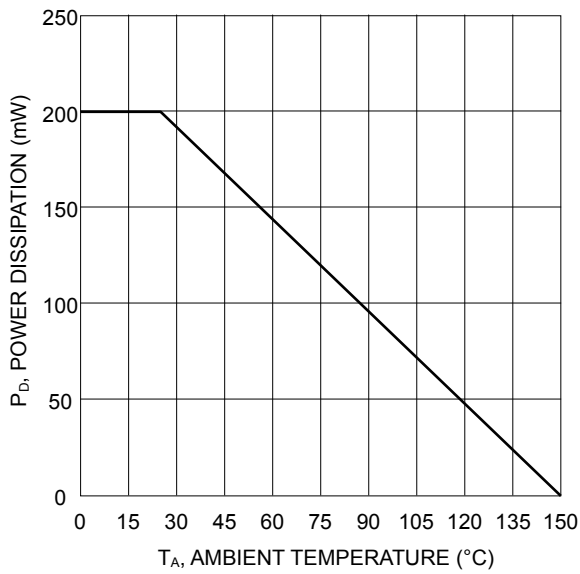

Fig. 1 Power Derating Curve

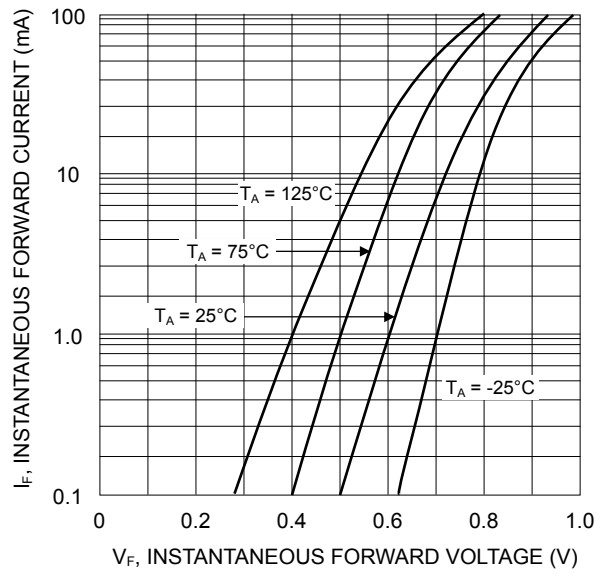

Fig. 2 Typical Forward Characteristics

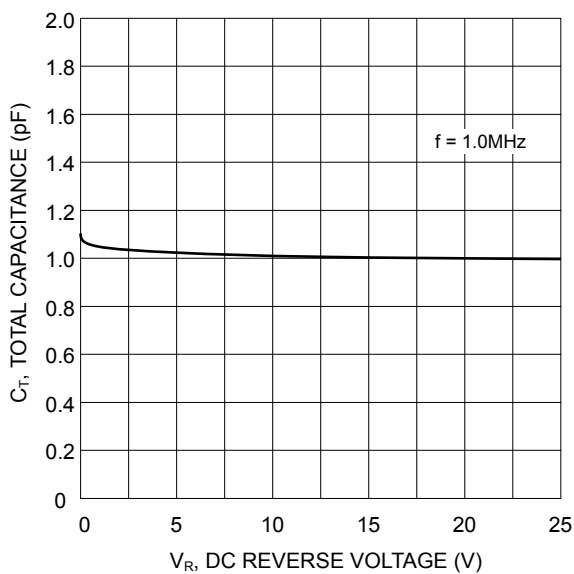

Fig. 3 Total Capacitance vs. Reverse Voltage

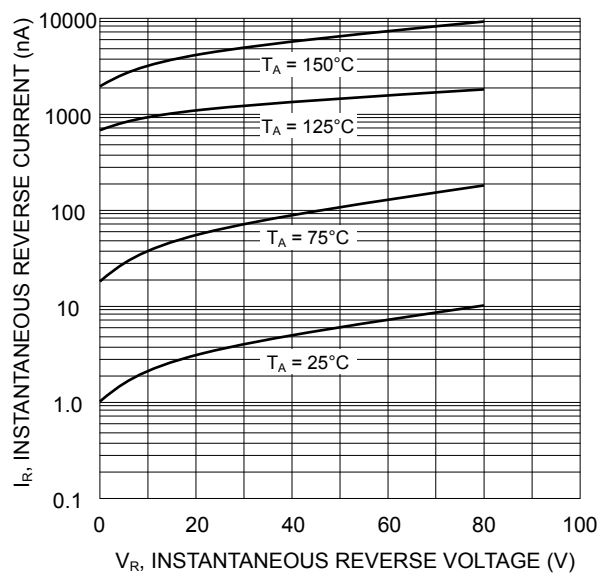
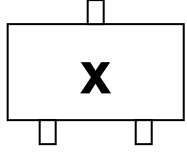

Fig. 4 Typical Reverse Characteristics

MARKING INFORMATION



x = Device Code, See Table Below

DAP202U	DAN202U
P	N

RECOMMENDED FOOTPRINT

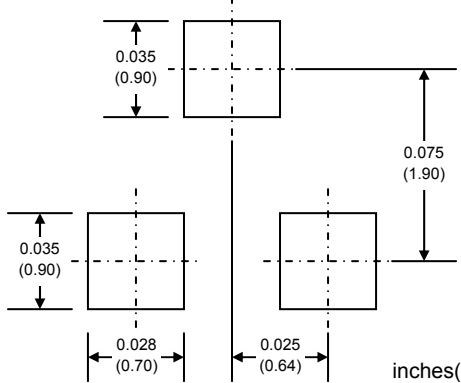

0.035 (0.90)
0.075 (1.90)
0.028 (0.70)
0.025 (0.64)
inches(mm)

PACKAGING INFORMATION

TAPE & REEL

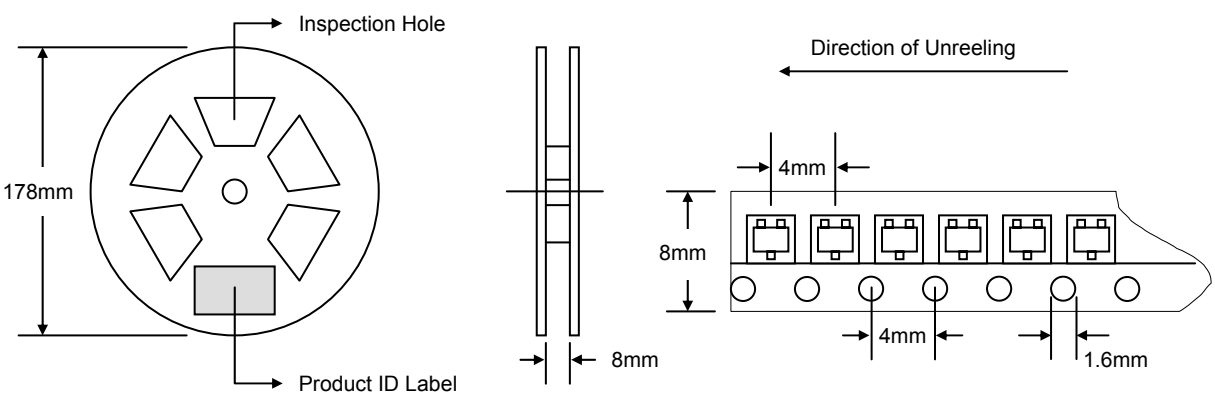

Reel Diameter (mm)	Quantity (PCS)	Inner Box Size L x W x H (mm)	Quantity (PCS)	Carton Size L x W x H (mm)	Quantity (PCS)	Approx. Gross Weight (KG)
178	3,000	187 x 187 x 65	15,000	390 x 240 x 420	150,000	10.0

Note: 1. Anti-static plastic reel, white, water clear or blue color. Inspection hole might be varied in different alignment.
2. Components are packed in accordance with EIA standard 481-1 and 481-2.

ORDERING INFORMATION

Product No.	Package Type	Shipping Quantity
DAP202U-T1	SOT-323	3000/Tape & Reel
DAN202U-T1	SOT-323	3000/Tape & Reel

1. Shipping quantity given is for minimum packing quantity only. For minimum order quantity, please consult the Sales Department.
2. **To order RoHS / Lead Free version (with Lead Free finish), add "-LF" suffix to part number above. For example, DAP202U-T1-LF.**

WON-TOP ELECTRONICS and  are registered trademarks of Won-Top Electronics Co., Ltd (WTE). WTE has checked all information carefully and believes it to be correct and accurate. However, WTE cannot assume any responsibility for inaccuracies. Furthermore, this information does not give the purchaser of semiconductor devices any license under patent rights to manufacturer. WTE reserves the right to change any or all information herein without further notice.

WARNING: DO NOT USE IN LIFE SUPPORT EQUIPMENT. WTE power semiconductor products are not authorized for use as critical components in life support devices or systems without the express written approval.

Won-Top Electronics Co., Ltd.
No. 44 Yu Kang North 3rd Road,
Chine Chen Dist., Kaohsiung 806, Taiwan
Phone: 886-7-822-5408 or 886-7-822-5410
Fax: 886-7-822-5417
Email: sales@wontop.com
Internet: <http://www.wontop.com>

We power your everyday.