



DB106G

DIODE

1.0A GLASS PASSIVATED SINGLE-PHASE BRIDGE RECTIFIER

DESCRIPTION

The UTC **DB106G** is a 1.0A glass passivated single-phase bridge rectifier.

The UTC **DB106G** is suitable for automatic insertion.

FEATURES

- * Surge overload ratings to 30 amperes peak
- * Recommended for non-automatic applications
- * Suitable for automatic insertion
- * Glass passivated chip junctions

SYMBOL

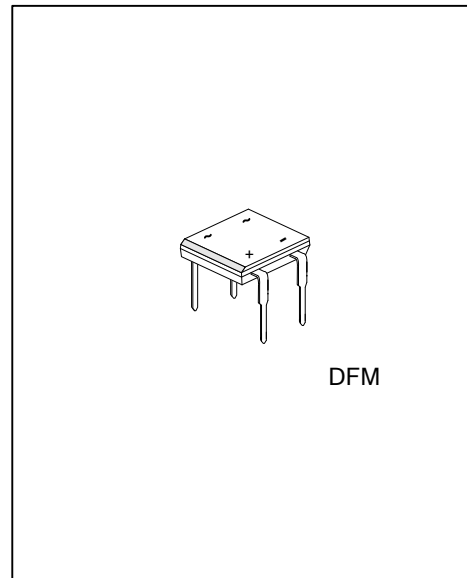
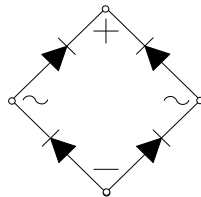

ORDERING INFORMATION

Ordering Number		Package	Packing
Lead Free	Halogen Free		
DB106GL-DFM-T	DB106GP-DFM-T	DFM	Tube

<p>DB106GL-DFM-T</p> <ul style="list-style-type: none"> (1) Packing Type (2) Package Type (3) Green Package 	<ul style="list-style-type: none"> (1) Tube: Tube (2) DFM: DFM (3) L: Lead Free, P: Halogen Free and Lead Free
--	---

MARKING

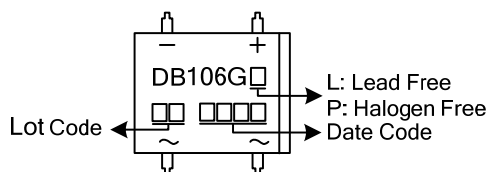

■ ABSOLUTE MAXIMUM RATINGS ($T_A=25^\circ\text{C}$ unless otherwise noted)

PARAMETER	SYMBOL	RATINGS	UNIT
Repetitive Peak Reverse Voltage	V_{RRM}	800	V
RMS Voltage	V_{RMS}	560	V
Continuous Reverse Voltage	V_R	800	V
Forward Rectified Current 0.06"(1.5mm) lead length at $T_A=40^\circ\text{C}$ (Note 2)	I_o	1.0	A
Peak Forward Surge Current 8.3ms Single Half Sine-Wave Superimposed on Rated Load	I_{FSM}	50	A
I^2t Rating for Fusing $t < 8.3\text{ms}$	I^2t	10	A^2s
Operating Temperature	T_J	-65~+150	$^\circ\text{C}$
Storage Temperature	T_{STG}	-65~+150	$^\circ\text{C}$

Note: Absolute maximum ratings are those values beyond which the device could be permanently damaged.
Absolute maximum ratings are stress ratings only and functional device operation is not implied.

■ THERMAL CHARACTERISTICS (Note 2)

PARAMETER	SYMBOL	RATINGS	UNIT
Junction to Ambient	θ_{JA}	40	$^\circ\text{C/W}$

■ ELECTRICAL CHARACTERISTICS ($T_A=25^\circ\text{C}$ unless otherwise noted)

PARAMETER	SYMBOL	TEST CONDITIONS	MIN	TYP	MAX	UNIT
Forward Voltage ($t < 8.3\text{ms}$)	V_F	$I_F=1.0\text{A}$			1.10	V
DC Reverse Current at Rated DC Blocking Voltage	I_R	$V_R=V_{RRM}, T_A=25^\circ\text{C}$			10	μA
		$V_R=V_{RRM}, T_A=100^\circ\text{C}$			500	μA
Junction Capacitance Per Element (Note 1)	C_J			25		pF

Notes: 1. Measured at 1.0MHz and applied reverse voltage of 4.0V D.C.

2. Mounted on P.C.B with 0.51"×0.51"(13×13mm) copper pads.

TYPICAL CHARACTERISTICS

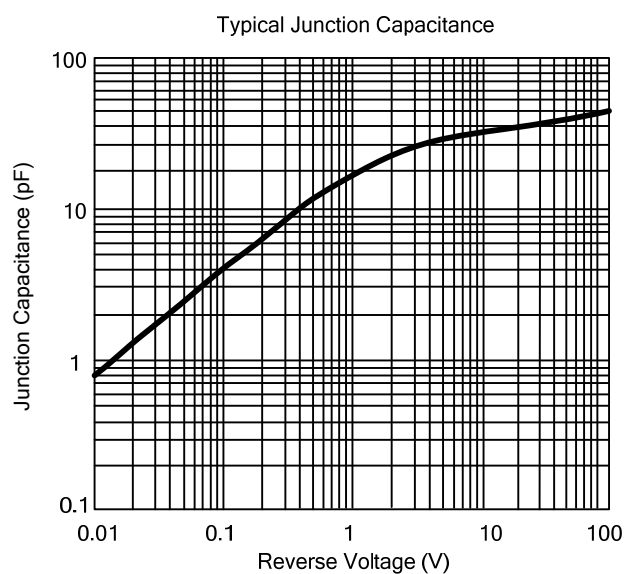
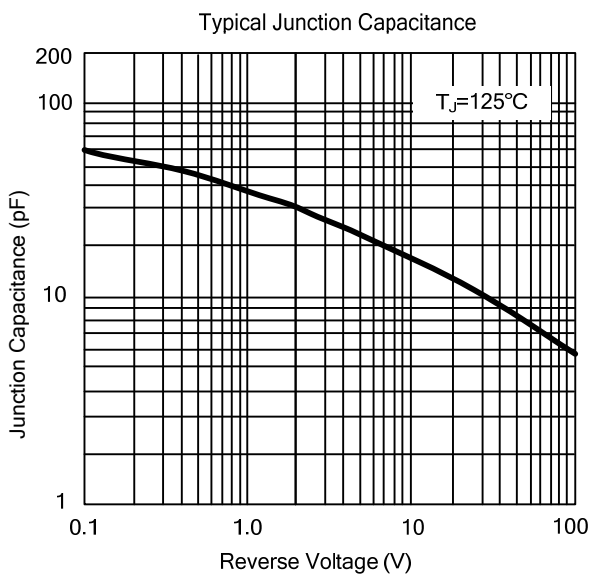
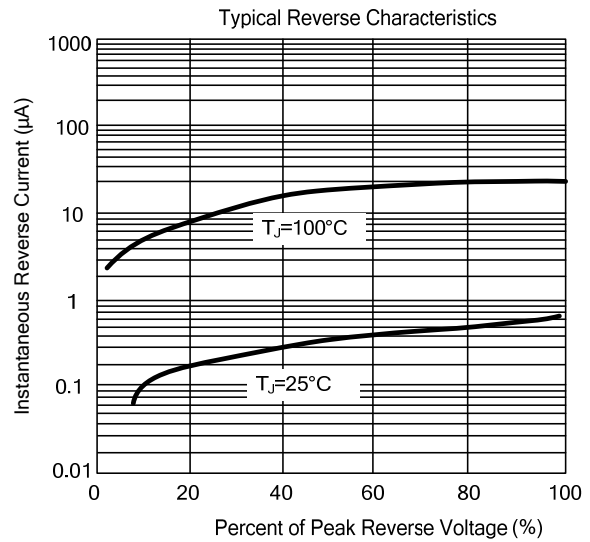
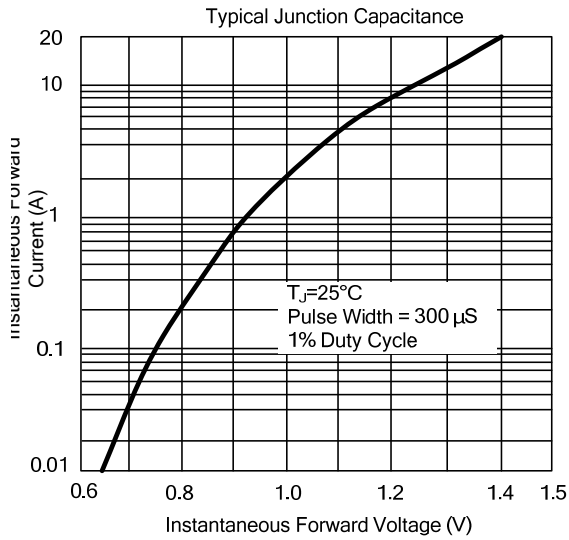
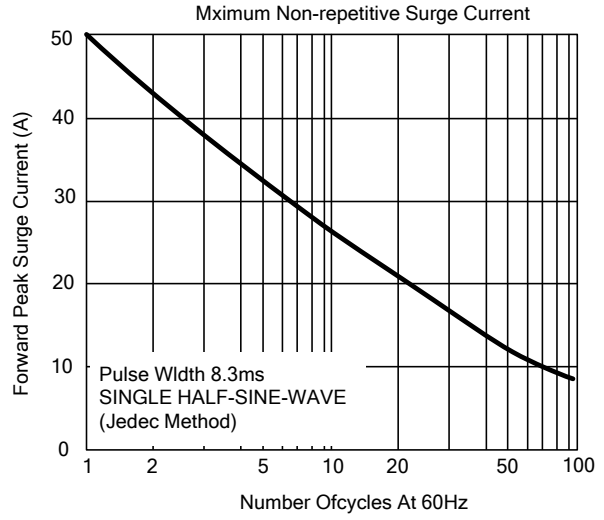
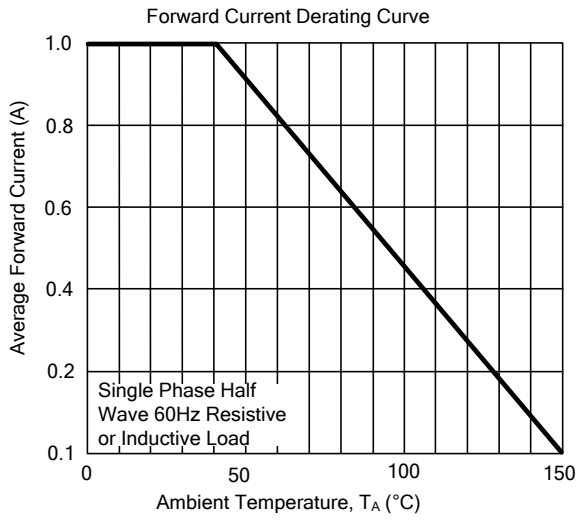

UTC assumes no responsibility for equipment failures that result from using products at values that exceed, even momentarily, rated values (such as maximum ratings, operating condition ranges, or other parameters) listed in products specifications of any and all UTC products described or contained herein. UTC products are not designed for use in life support appliances, devices or systems where malfunction of these products can be reasonably expected to result in personal injury. Reproduction in whole or in part is prohibited without the prior written consent of the copyright owner. The information presented in this document does not form part of any quotation or contract, is believed to be accurate and reliable and may be changed without notice.