



DB3

BI-DIRECTIONAL TRIGGER DIODES

DO-35玻璃封装双向触发二极管

符号 Symbol	参数 Parameter	测试条件 Test Condition	型号 Type	Min	Typ	Max	Unit	外型尺寸 Package (单位: mm)
V_{BO}	击穿电压 BREAKDOWN VOLTAGE	见图1 SEE FIG 1	DB-3 DB-4 DB-6	28 35 56	32 40 60	36 45 70	V	<p>DO-35尺寸图 (单位: mm)</p>
$ +V_{BO} - -V_{BO} $	击穿电压对称性 BREAKDOWN VOLTAGE SYMMETRY	见图1 SEE FIG 1	DB-3 DB-4 DB-6			3 3 4	V	
$ \pm \Delta V $	动态回弹电压 DYNAMIC BREAKBACK VOLTAGE	$\Delta I = I_{BO} \text{ to } I_F = 10\text{mA} $ 见图1 SEE FIG 1	DB-3 DB-4 DB-6	5 5 10			V	
V_O	输出电压 OUTPUT VOLTAGE	见图2 SEE FIG 2		5			V	
I_{BO}	击穿电流 BREAKDOWN current					100	μA	
t_r	上升时间 Rise time	见图3 SEE FIG 3			1.5		μs	
I_B	漏电电流 Bleakage Current	$V_m = 0.5V_{BO(\text{Max})}$ 见图1 SEE FIG 1				10	μA	

极限参数

LIMITING VALUES

符号 Symbol	参数 Parameter		Value	Unit
P_c	功耗 Power Dissipation On Pented Circuit	$t_a = 50^\circ C$	150	mW
I_{Fmax}	峰值脉冲电流	$t_p = 10 \mu s$ 120pps $T_a \leq 40^\circ C$	DB-3: 2.0 DB-4: 2.0 DB-6: 16	A
T_r	贮存与工作结温范围		40 to 125	$^\circ C$
T_j	Storage and Operation Junction Temperature Range		40 to 110	$^\circ C$

玻壳封装双向触发二极管特性曲线

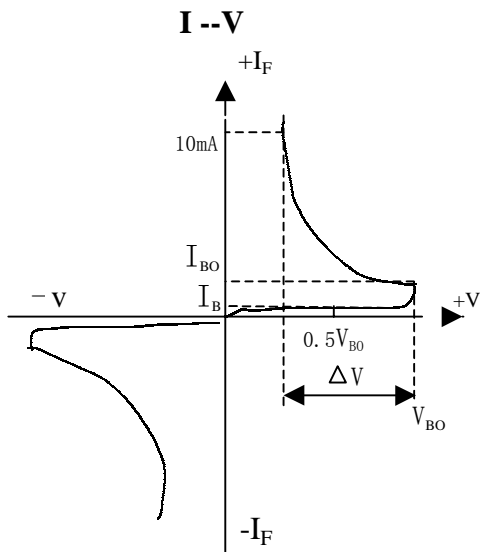

FIG-1 I - V 特性曲线
Current - voltage characteristics

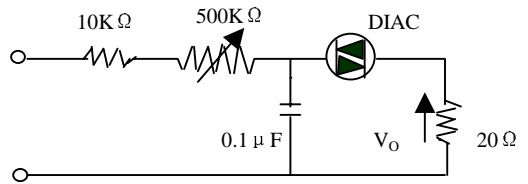

FIG-2 输出电压测试电路
Test circuit for output voltage

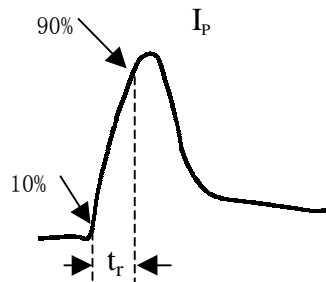

FIG-3 测试电路见图2, 调整R, $I_p=0.5A$
Test circuit see diagram 2, Adjust R for $I=0.5A$

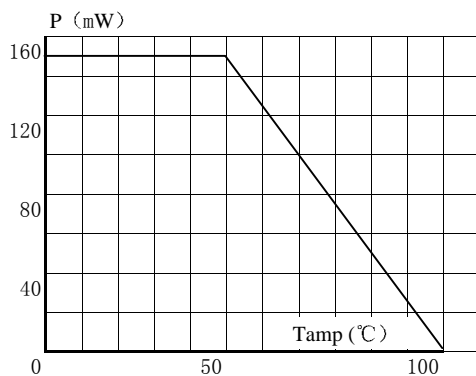

FIG -5 功耗环境温度关系曲线 (最大值)
Power dissipation versus ambient temperature (maximum values)

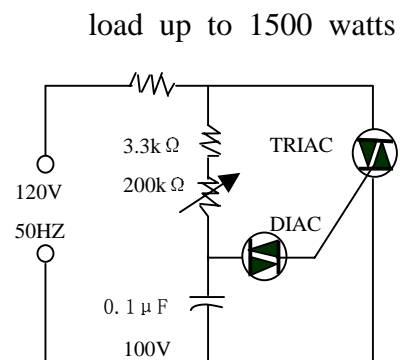

FIG-4 典型DIAC-TRIAC 全波相控电路
Typical DIAC-TRIAC full-wave phase control

DO-35 玻壳封装双向触发二极管特性曲线

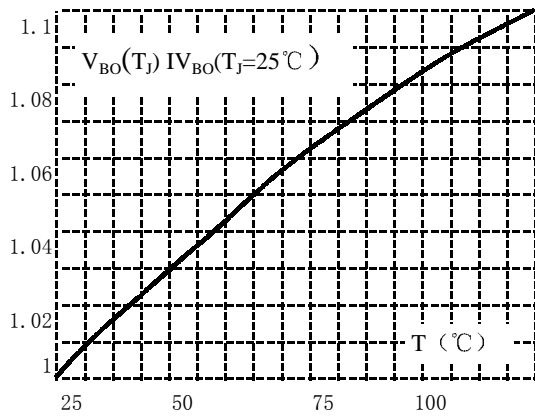

FIG-6 V_{BO} 的相对变化与结温关系曲线（典型值）
Relative variation of V_{BO} versus temperature (typical values)

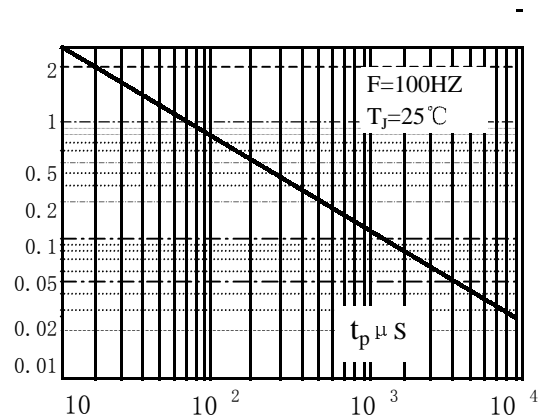

FIG-7 峰值脉冲电流与脉冲宽度关系曲线（最大值）
Peak Pulse Current Versus Pulse duration (maximum values)