

Triac / Sensitive Gate

Features

Repetitive Peak Off-State Voltage : 600V
 R.M.S On-State Current ($I_{T(RMS)} = 8 \text{ A}$)
 High Commutation dv/dt
 Sensitive Gate Triggering 3 Mode
 ($I_{GT} = 10\text{mA}$)
 Isolation Voltage ($V_{ISO} = 2500\text{V AC}$)

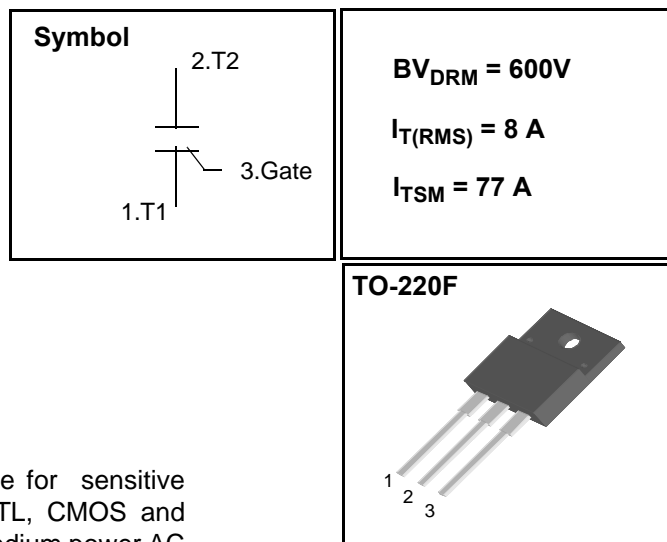

General Description

This device is fully isolated package suitable for sensitive gate triggering , direct coupling to TTL, HTL, CMOS and application such as various logic functions,medium power AC switching applications, such as fan speed control, lighting controllers and home appliance equipment.

Absolute Maximum Ratings ($T_J = 25^\circ\text{C}$ unless otherwise specified)

Symbol	Parameter	Condition	Ratings	Units
V_{DRM}	Repetitive Peak Off-State Voltage	Sine wave, 50 to 60 Hz, Gate Open	600	V
$I_{T(RMS)}$	R.M.S On-State Current	$T_C = 76^\circ\text{C}$	8.0	A
I_{TSM}	Surge On-State Current	One Cycle, 50Hz/60Hz, Peak, Non-Repetitive	70/77	A
I^2t	I^2t for fusing	$t = 10\text{ms}$	24	A^2s
P_{GM}	Peak Gate Power Dissipation	$T_C = 76^\circ\text{C}$, Pulse width 1.0us	5.0	W
$P_{G(AV)}$	Average Gate Power Dissipation	Over any 20ms period	0.5	W
I_{GM}	Peak Gate Current	$t_p = 20\mu\text{s}$, $T_J = 125^\circ\text{C}$	2.0	A
V_{GM}	Peak Gate Voltage	$t_p = 20\mu\text{s}$, $T_J = 125^\circ\text{C}$	10	V
V_{ISO}	Isolation Breakdown Voltage(R.M.S.)	A.C. 1 minute	2500	V
T_J	Operating Junction Temperature		- 40 ~ 125	$^\circ\text{C}$
T_{STG}	Storage Temperature		- 40 ~ 150	$^\circ\text{C}$

DBT137F-600

Electrical Characteristics

Symbol	Items		Conditions	Ratings			Unit
				Min.	Typ.	Max.	
I_{DRM}	Repetitive Peak Off-State Current		$V_D = V_{DRM}$, Single Phase, Half Wave $T_J = 125\text{ }^\circ\text{C}$			1.0	mA
V_{TM}	Peak On-State Voltage		$I_T = 10\text{ A}$, Inst. Measurement			1.6	V
I_{GT1}^+		Gate Trigger Current	$V_D = 6\text{ V}$, $R_L = 10$			10	mA
I_{GT1}^-						10	
I_{GT3}^-						10	
I_{GT3}^+	IV				25		
V_{GT1}^+		Gate Trigger Voltage	$V_D = 6\text{ V}$, $R_L = 10$			1.5	V
V_{GT1}						1.5	
V_{GT3}						1.5	
V_{GT3}^+	IV					2.5	
V_{GD}	Non-Trigger Gate Voltage		$T_J = 125\text{ }^\circ\text{C}$, $V_D = 1/2 V_{DRM}$	0.2			V
$(dv/dt)_c$	Critical Rate of Rise Off-State Voltage at Commutation		$T_J = 125\text{ }^\circ\text{C}$, $[di/dt]_c = -3.0\text{ A/ms}$, $V_D = 2/3 V_{DRM}$	5.0			V/ μs
I_H	Holding Current				10		mA
$R_{th(j-c)}$	Thermal Impedance		Junction to case (Half Cycle)			3.8	$^\circ\text{C/W}$

DBT137F-600

Fig 1. Gate Characteristics

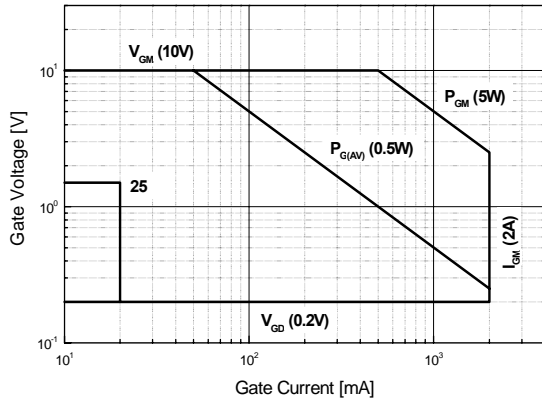

Fig 2. On-State Voltage

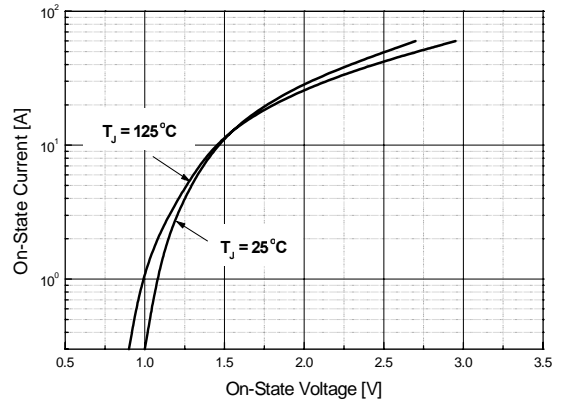

Fig 3. On State Current vs. Maximum Power Dissipation

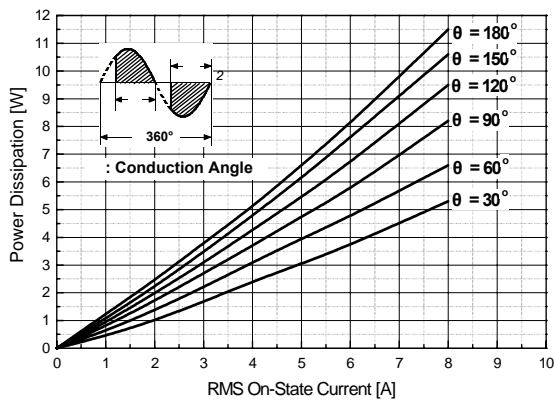

Fig 4. On State Current vs. Allowable Case Temperature

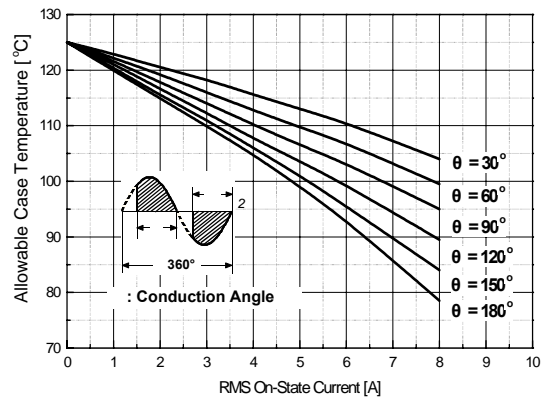

Fig 5. Surge On-State Current Rating (Non-Repetitive)

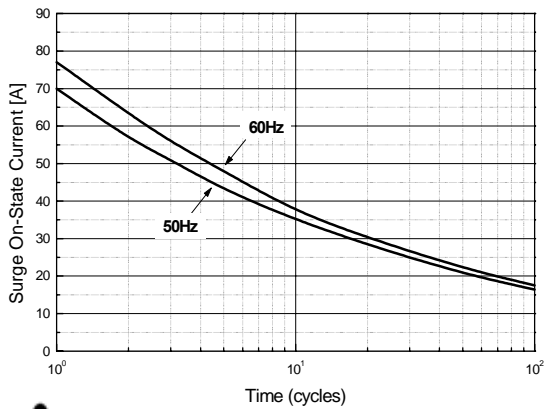
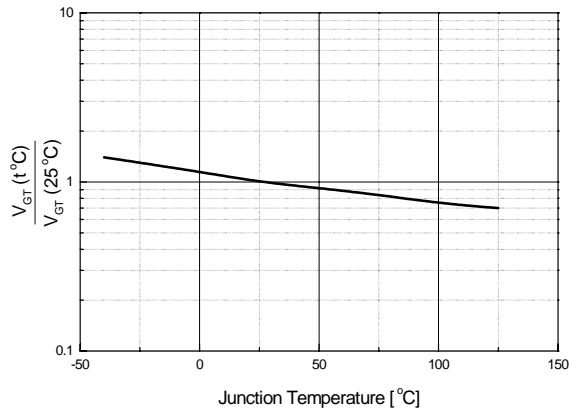

Fig 6. Gate Trigger Voltage vs. Junction Temperature



DBT137F-600

Fig 7. Gate Trigger Current vs. Junction Temperature

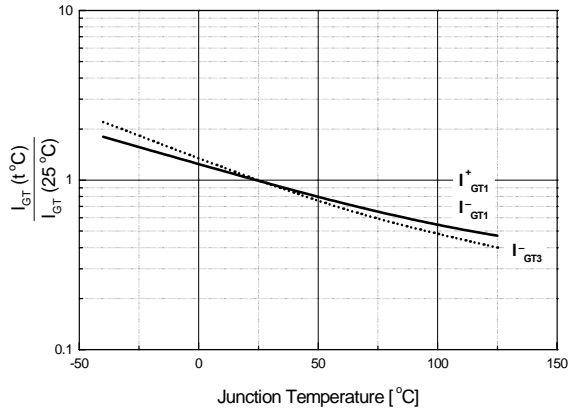

Fig 8. Transient Thermal Impedance

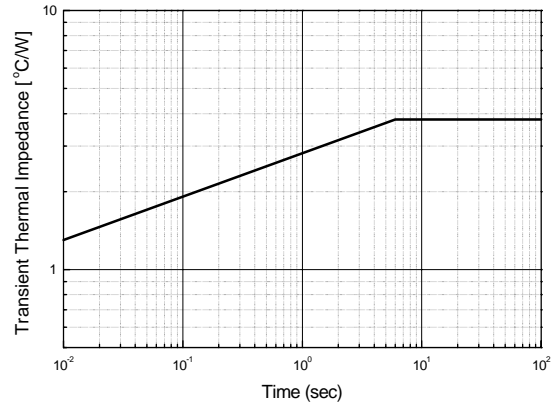
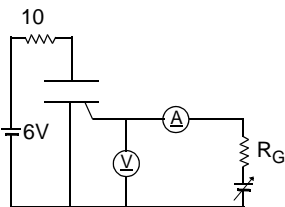
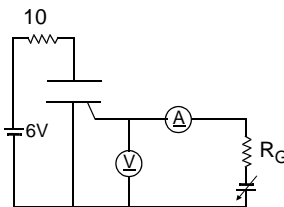

Fig 9. Gate Trigger Characteristics Test Circuit



Test Procedure



Test Procedure

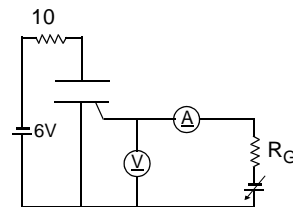

Test Procedure

DBT137F-600

TO-220F Package Dimension

Dim.	mm			Inch		
	Min.	Typ.	Max.	Min.	Typ.	Max.
A	10.4		10.6	0.409		0.417
B	6.18		6.44	0.243		0.254
C	9.55		9.81	0.376		0.386
D	13.47		13.73	0.530		0.540
E	6.05		6.15	0.238		0.242
F	1.26		1.36	0.050		0.054
G	3.17		3.43	0.125		0.135
H	1.87		2.13	0.074		0.084
I	2.57		2.83	0.101		0.111
J		2.54			0.100	
K		5.08			0.200	
L	2.51		2.62	0.099		0.103
M	1.25		1.55	0.049		0.061
N	0.45		0.63	0.018		0.025
O	0.6		1.0	0.024		0.039
		3.7			0.146	
1		3.2			0.126	
2		1.5			0.059	

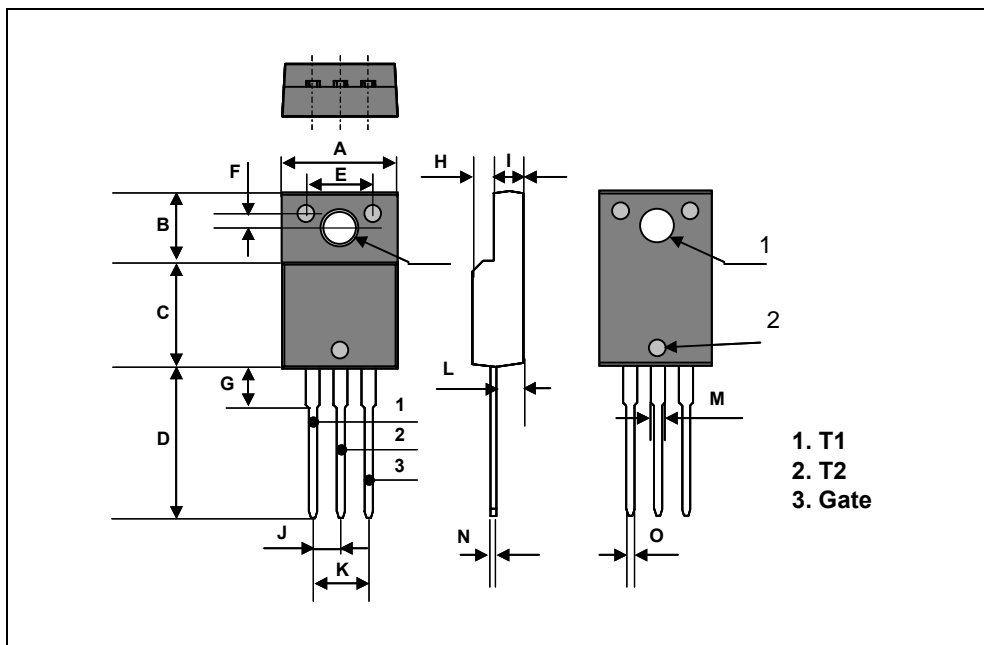

DBT137F-600

TO-220F Package Dimension, Forming

Dim.	mm			Inch		
	Min.	Typ.	Max.	Min.	Typ.	Max.
A	10.4		10.6	0.409		0.417
B	6.18		6.44	0.243		0.254
C	9.55		9.81	0.376		0.386
D	8.4		8.66	0.331		0.341
E	6.05		6.15	0.238		0.242
F	1.26		1.36	0.050		0.054
G	3.17		3.43	0.125		0.135
H	1.87		2.13	0.074		0.084
I	2.57		2.83	0.101		0.111
J		2.54			0.100	
K		5.08			0.200	
L	2.51		2.62	0.099		0.103
M	1.25		1.55	0.049		0.061
N	0.45		0.63	0.018		0.025
O	0.6		1.0	0.024		0.039
P		5.0			0.197	
		3.7			0.146	
1		3.2			0.126	
2		1.5			0.059	

