

SPECIFICATION FOR APPROVAL

(ANALOG RGB AND VIDEO INTERFACE CONTROLLER FOR TFT-LCD
INTERFACE)

MODEL : DCMR-3C

APPROVE	REFERENCE

(PLEASE RETURN ONE OF THESE TO US IMMEDIATELY WITH YOUR SIGNATURE FOR APPROVAL)

Content of Specification

<u>1.</u>	<u>Revision History</u>	<u>4</u>
<u>2.</u>	<u>Product Overview</u>	<u>5</u>
<u>3.</u>	<u>Features</u>	<u>5</u>
<u>4.</u>	<u>System Configuration</u>	<u>6</u>
<u>5.</u>	<u>Electrical Specifications</u>	<u>6</u>
5.1.	Video input timing	6
5.2.	Electrical Characteristics	8
<u>6.</u>	<u>Operational Setup</u>	<u>9</u>
<u>7.</u>	<u>OSD (On-Screen-Display)</u>	<u>10</u>
7.1.	Main Menu	10
7.2.	Sub-Menu : Color	11
7.3.	Sub-Menu : Image Setting	12
7.4.	Sub-Menu : Position	13
7.5.	Sub-Menu : OSD Menu	14
7.6.	Sub-Menu: Language	15
7.7.	Sub-Menu: Misc.	16
<u>8.</u>	<u>Input Connectors</u>	<u>17</u>
8.1.	Power Input connector	17
8.2.	CVBS Input connector	17
8.3.	Analog RGB Input connector	18

8.4.	OSD, LED Interface Connector (J502)	18
8.5.	External Power Connector (J501)	18
9.	<u>Output Connectors for LCD Interface</u>	19
9.1.	LVDS Interface (J500).....	19
9.2.	Backlight Power Connector (J503)	19
10.	<u>Mechanical Dimension</u>	20
11.	<u>Reliability</u>	21
12.	<u>Absolute maximum ratings</u>	21
13.	<u>Mounting rules</u>	21
14.	<u>Operating Precautions</u>	21
15.	<u>General Cautions</u>	22

1. Revision History

Version	Date	Section	Description
Ver 1.0	01.12.07	All	DCMR-3C Specification
Ver 1.1	8.07.09	All	DCMR-3C. Language update

2. Product Overview

This board accepts standard analog RGB and SYNC (CRT like) signals from any VGA to UXGA video controller and Composite PAL or NTSC signals. And also generates all the necessary control signals and the panel data to drive TFT-LCDs. This board supports to UXGA resolutions.

The user interface includes Phase, Brightness, Contrast, Horizontal and Vertical Position adjustment, etc. via on-screen programming.

3. Features

- Support up to SXGA / WXGA+.
- Input format detection
- Compatibility with standard VESA Mode and support user-defined mode.
- Smart engine for Phase/Image Position/Color calibration.
- Sharpness/Smooth filter enhancement.
- Support Sync On Green and various kinds of composite sync modes.
- Integrated 8-bit triple channel 165MHz ADC/PLL
- Dynamic contrast control / Independent color control.
- User friendly On Screen Display Menu to control image
 - Auto-Adjust
 - Color Adjust (Contrast, Brightness, etc.)
 - Image Setting (Clock, Phase, etc.)
 - Image Position
 - OSD Setting
 - Input Source Select
 - Reset
- Power management support (DPMS - VESA compliant)

4. System Configuration

- Figure 1. System Block Diagram

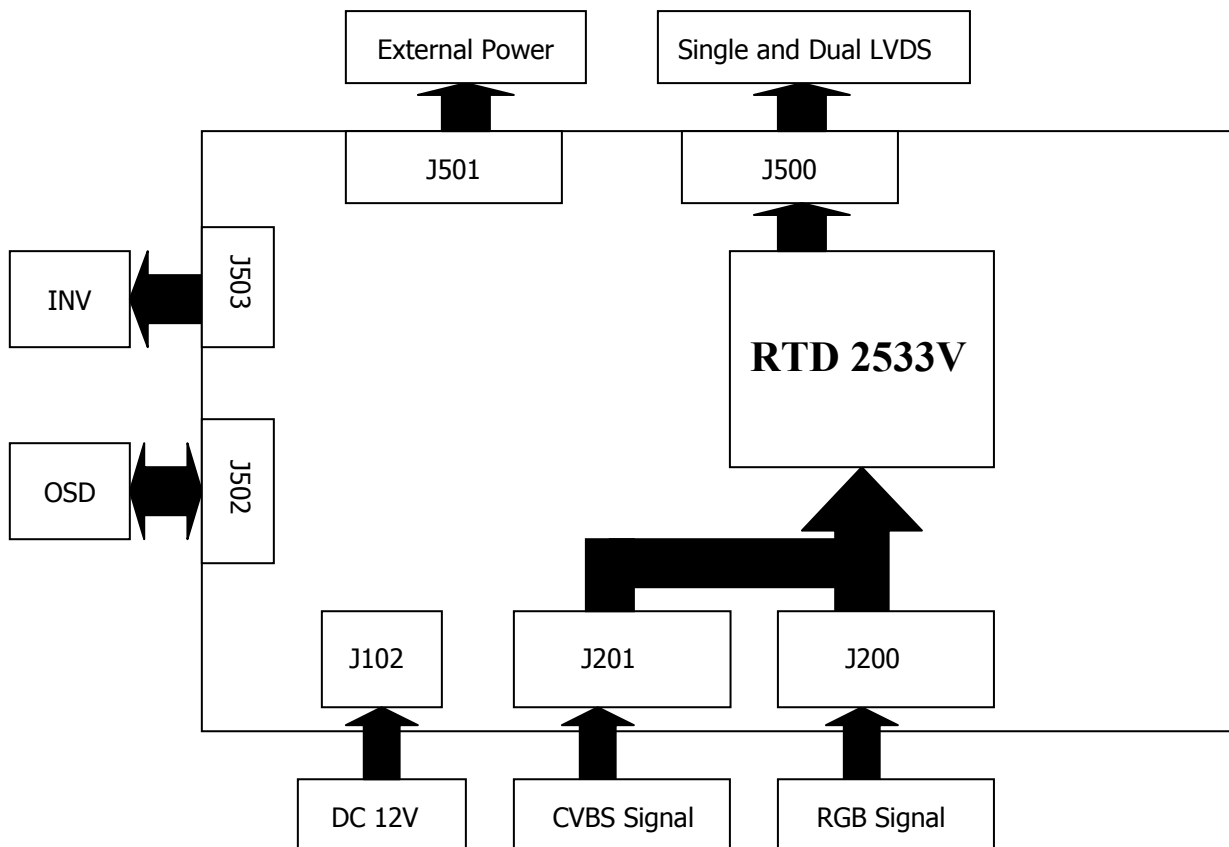

5. Electrical Specifications

5.1. Video input timing

- Supported vertical refresh rates for each modes as follow:
 - 640x350 70HZ
 - 640x350 85HZ
 - 720x400 70HZ
 - 720x400 85HZ
 - 640x480 60~85HZ
 - 800x600 56~85HZ

- 832x624* 75HZ
- 1024x768 60~85HZ
- 1024x800* 73HZ
- 1024x800* 85HZ
- 1152x864* 60~85HZ
- 1152x900* 66HZ
- 1152x900* 76HZ
- 1280x720* 60HZ
- 1280x720* 75HZ
- 1280x768* 60~75HZ
- 1280x800* 60~75HZ
- 1280x960* 60~85HZ
- 1280x1024 60~85HZ
- 1360x768* 60~75HZ
- 1440x900* 60HZ
- 1440x900* 75HZ
- 1600x1200 60~85HZ
- 1680x1050* 60HZ
- 1680x1050* 75HZ
- 1920x1200* 60~75HZ
- Sync. : H/V Separate, Sync On Green, Interlace
- Video:
 - RGB Analog (75 Ohm, 0.7Vp-p)
 - Composite video (NTSC or PAL)

* Depends on VGA signal source

5.2. Electrical Characteristics

Item	Symbol	Condition	MIN.	TYP.	MAX.	Unit
Supply Voltage		-----	7	12.0		Vdc
Absolute Max. Rating		-----	7	12.0		Vdc
Current Consumption ¹		Board Only	0.4	0.5	0.55	A
		With HT15X15- D01				A
In rush current				~		
Ext. power out Con101	5V	5 V Module PW		5		V
	12V	12 V Module PW		12		V

¹ Test was performed with the BOE Hydix HT15X15-D01 and inverters which are made by Frontek Inc

6. Operational Setup

The OSD provides certain functions to have clear image and others.

There are 5 buttons to control the OSD, PCB board and 1 LED for show status of board.

OSD Board

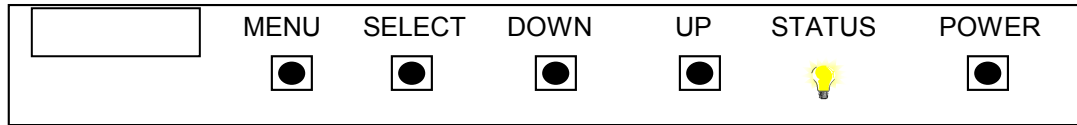

Function of each OSD key

No.	Button	Switch Function
1	Menu	1. Open the OSD Main Menu / Close the OSD Main Menu
2	Select	1. Select a Item
3	Down	1. Move to downside on menu list 2. decrease the value of selected item
4	Up	1. Move to upside on menu list 2. Increase the value of selected item
5	Power	1. Turn on power / Turn off power

- ◆ Hot-Key: One-click control
 - Auto adjust: "down" key
 - Source Switch (analog RGB, DVI) : "select" key
- ◆ Status LED
 - Green: Normal State
 - Amber flashing: DPMS mode (Can't find signal)

7. OSD (On-Screen-Display)

7.1. Main Menu



Color:	Adjust and correct the color
Image Setting:	Adjust and correct the image
Position:	Adjust the H-/V- Position of display
OSD Menu:	Adjust the On-Screen-Display
Language:	Select a language of OSD
Misc.:	All other settings
Exit:	Close the main menu

7.2. Sub-Menu : Color

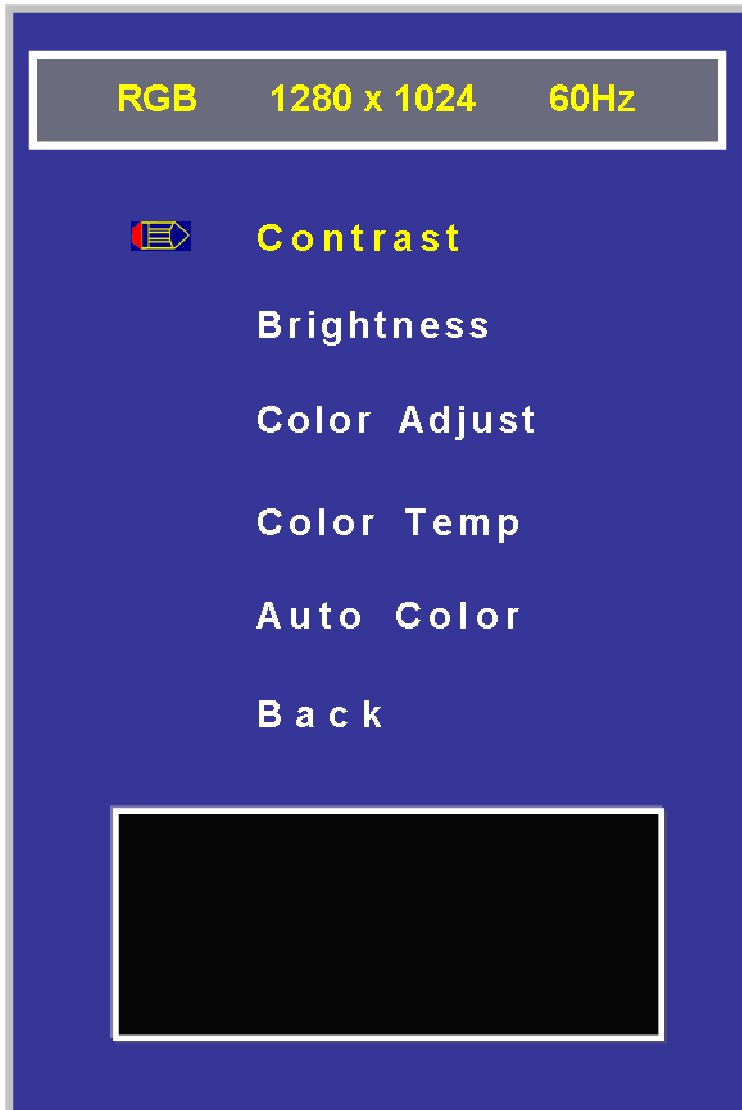

Contrast:	Adjust the contrast of the image
Brightness:	Adjust the brightness of the image
Color Adjust:	Adjust the value of red, green and blue
Color Temp:	Adjust the color temperature
Auto Color:	Run the auto config of the Color
Back:	Back to main menu

7.3. Sub-Menu : Image Setting

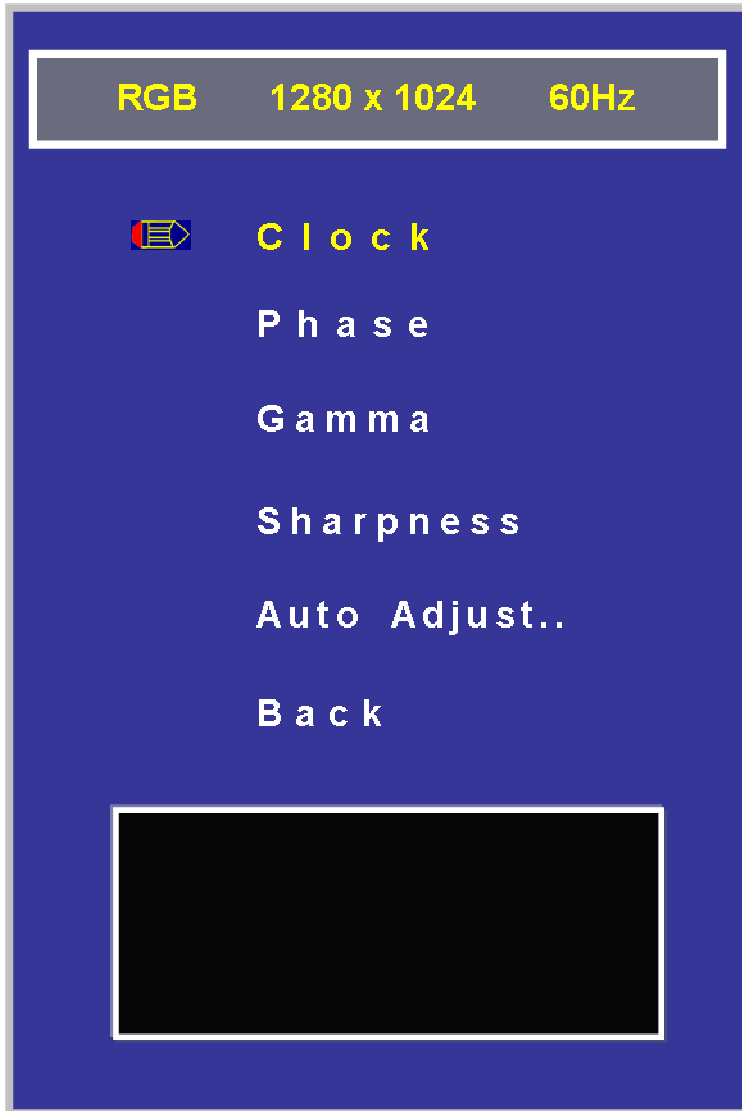

Clock:	Adjust the clock of the image
Phase:	Adjust the phase of the image
Gamma:	Adjust gamma level of the image
Sharpness:	Adjust the sharpness of the image
Auto Adjust:	Run the auto config of the image
Back:	Back to main menu

7.4. Sub-Menu : Position

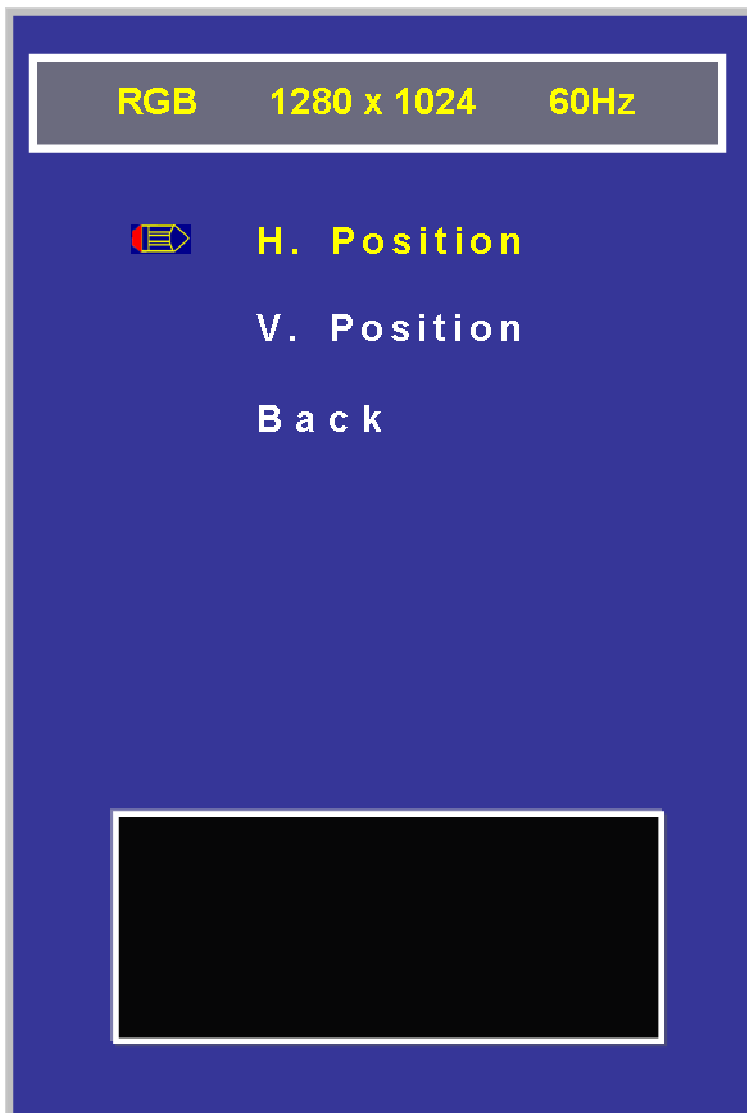

H. Position: Adjust the H. position of the image

V. Position: Adjust the V. position of the image

Back: Back to main menu

7.5. Sub-Menu : OSD Menu



- OSD H. Pos.: Adjust the H. position of the OSD
OSD V. Pos.: Adjust the H. position of the OSD
OSD Timer: Adjust the OSD off timer
Back: Back to main menu

7.6. Sub-Menu: Language

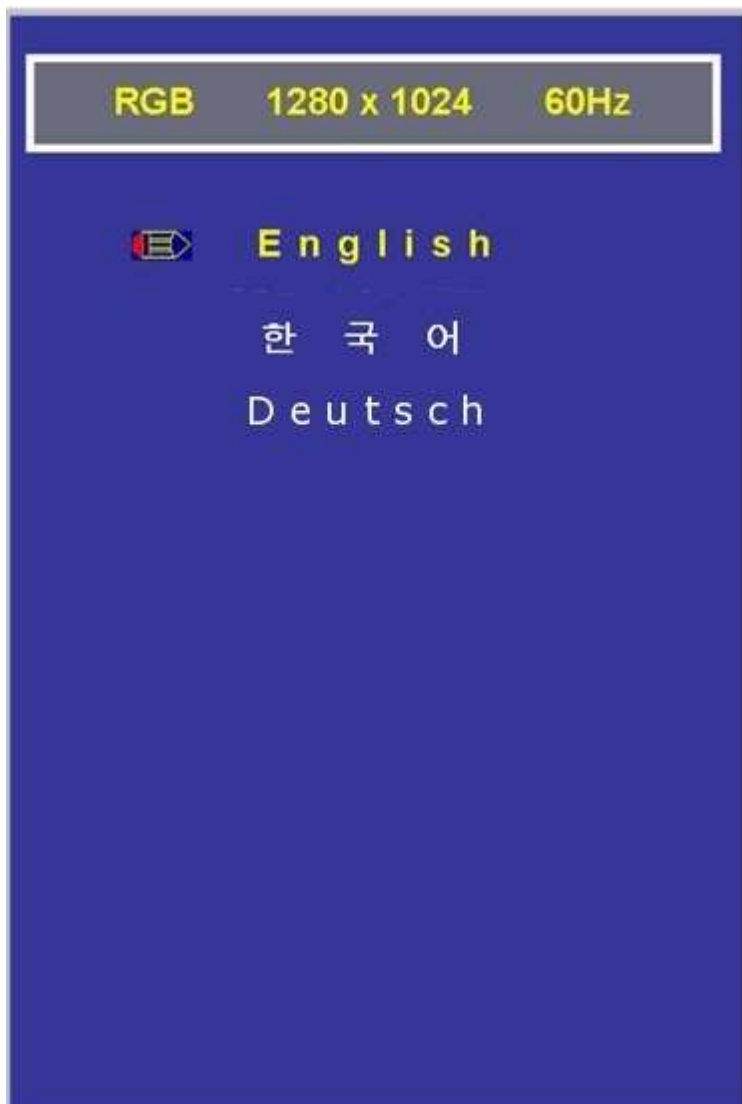

Korean: Select a Korean
English: Select a English
Deutsch: Select a Germany

7.7. Sub-Menu: Misc.

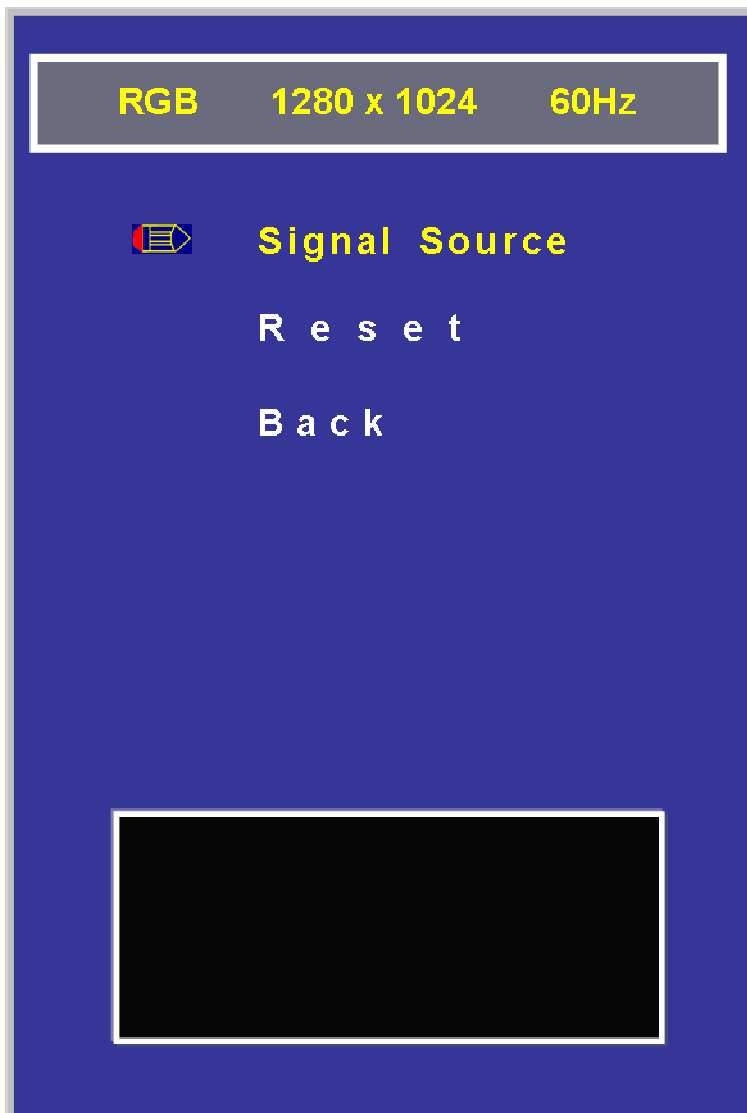

Signal Source: Select the input source

Reset: Factory reset

Back: Back to main menu

8. Input Connectors

8.1. Power Input connector

- Power input connector (J100) : 2.5 Power DC Jack

Pin No.	Symbol	Description
1	Vin	+12Vdc
2	GND	GND

- Power input connector (J102) : 20022WR-04/NC

Pin No.	Symbol	Description
1	Vin	+12Vdc
2	GND	GND

8.2. CVBS Input connector

- CVBS Input connector (J201)

Pin No.	Symbol	Signal Name
1	GND	Ground
2	Sign	CVBS signal
3	Sign	CVBS signal
4	GND	Ground

8.3. Analog RGB Input connector

- RGB Input connector (J200) : 20022WR-13

Pin No.	Symbol	Signal Name	Pin No.	Symbol	Signal Name
1	HSYNC	Horizontal Sync	8	GND	Ground
2	GND	Ground	9	RED	Analog RED
3	VSYNC	Vertical Sync	10	GND	Ground
4	GND	Ground	11	SCL	DDC Data Clock
5	BLUE	Analog BLUE	12	SDA	DDC Data
6	GND	Ground	13	NC	No Connect
7	GREEN	Analog GREEN			

8.4. OSD, LED Interface Connector (J502)

- 12505WR-14 by Yeonho (2mm Pitch / 14 Pin)

Pin No.	Symbol	Signal Name	Pin No.	Symbol	Signal Name
1	LED_R	LED RED	8	NC	No Connect
2	LED_R	LED GREEN	9	NC	No Connect
3	GND	Ground	10	KEY4	Down KEY
4	KEY1	Vol -	11	KEY5	Up KEY
5	NC	No Connect	12	KEY6	Menu Key
6	KEY2	Vol +	13	NC	No Connect
7	KEY3	Power KEY	14	NC	No Connect

8.5. External Power Connector (J501)

- 20022WR-04/NC by Yeonho (2mm Pitch / 4 Pin)

Pin No.	Symbol	Description
1	12	DC 12V
2	GND	Ground
3	GND	Ground
4	5	DC 5V

9. Output Connectors for LCD Interface

9.1. LVDS Interface (J500)

- 12507WR-30 by Yeonho (1.25mm Pitch / 30 Pin)

Pin No	Description	Pin No.	Description	Pin No.	Description
1	VCC	11	RXOIN1 -	21	RXEIN0 +
2	VCC	12	RXOIN1 +	22	RXEIN1 -
3	VCC	13	RXOIN2 -	23	RXEIN1 +
4	VCC	14	RXOIN2 +	24	RXEIN2 -
5	NC	15	RXOCKIN -	25	RXEIN2 +
6	GND	16	RXOCKIN +	26	RXECKIN -
7	GND	17	RXOIN3 -	27	RXECKIN +
8	GND	18	RXOIN3 +	28	RXEIN3 -
9	RXOIN0 -	19	GND	29	RXEIN3 +
10	RXOIN0 +	20	RXEIN0 -	30	GND

9.2. Backlight Power Connector (J503)

- 12505WR-07 by Yeonho (1.25mm Pitch / 7 Pin)

Pin No.	Symbol	Description
1	GND	Ground
2	GND	Ground
3	GND	Ground
4	ADJ	0.0 ~ 5.0 Vdc
5	On / Off	0 / 5 Vdc(High Active)
6	Vin	+12Vdc Input
7	Vin	+12Vdc Input

11. Reliability

Test item	Condition
High temperature storage test	+70°
Low temperature storage test	-20°
High temperature operation test	+60°
Low temperature operation test	-10°
Vibration test	
Shock test	
Altitude test	
Humidity test	

12. Absolute maximum ratings

Test item	Condition
High temperature storage	+70°
Low temperature storage	-20°
High temperature operation	+60°
Low temperature operation ²	-10°

13. Mounting rules

- You must mount a module using holes arranged in four corners.
- Avoid any bend force during mounting

14. Operating Precautions

- The spike noise causes the mis-operation of circuits. It should be lower than following voltage : $V = \pm 200\text{mV}$ (Over and under shoot voltage)
- Be careful for condensation at sudden temperature change. Condensation makes damage to electrical contacted parts.
- Module has high frequency circuits. Sufficient suppression to the electromagnetic interference shall be done by system manufacturers. Grounding and shielding methods may be important to minimized the interference

² Phase shift or clock shift can appear between -10°C and 0°C

15. General Cautions

- Never touch the inverter (dc-ac) while power is connected. Inverter should be properly mounted in the system. All transformers on the inverter should be covered with non-conductive heat-resistant material. Inverter is a source of very high voltages. Precaution must be taken to avoid electrical shocks.
- When preparing a cable for a specific flat panel, always refer to appropriate cable pin-out and flat panel specification. Always check the flat panel signals before connecting the cable. Any incorrect pin connection may damage the flat panel permanently.
- Should you need any technical help, please contact Beck GmbH & Co. Elektronik Bauelemente KG