

**FEATURES**

- Double Side Cooling
- High Surge Capability

**APPLICATIONS**

- High Power Drives
- High Voltage Power Supplies
- Static Switches

**VOLTAGE RATINGS**

Part and Ordering Number	Repetitive Peak Voltages $V_{DRM}$ and $V_{RRM}$ V	Conditions
DCR1560F26	2600	$T_{vj} = -40^{\circ}\text{C}$ to $125^{\circ}\text{C}$ , $I_{DRM} = I_{RRM} = 150\text{mA}$ , $V_{DRM}, V_{RRM} t_p = 10\text{ms}$ , $V_{DSM} \& V_{RSM} =$ $V_{DRM} \& V_{RRM} + 100\text{V}$ respectively
DCR1560F24	2400	
DCR1560F22	2200	
DCR1560F20	2000	

Lower voltage grades available.

**ORDERING INFORMATION**

When ordering, select the required part number shown in the Voltage Ratings selection table.

For example:

**DCR1560F26**

Note: Please use the complete part number when ordering and quote this number in any future correspondence relating to your order.

**KEY PARAMETERS**

$V_{DRM}$	<b>2600 V</b>
$I_{T(AV)}$	<b>1560 A</b>
$I_{TSM}$	<b>24000 A</b>
$dV/dt^*$	<b>1000 V/<math>\mu\text{s}</math></b>
$dI/dt$	<b>200 A/<math>\mu\text{s}</math></b>

\* Higher  $dV/dt$  selections available

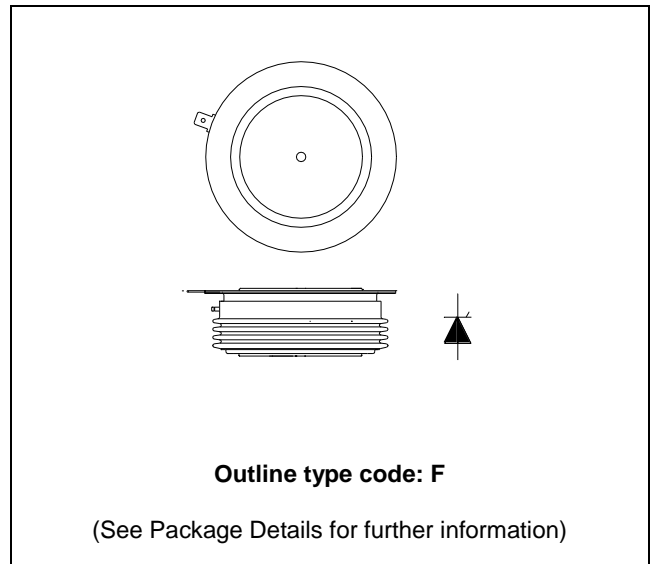

**Fig. 1 Package outline**

## CURRENT RATINGS

$T_{case} = 60^{\circ}\text{C}$  unless stated otherwise

Symbol	Parameter	Test Conditions	Max.	Units
<b>Double Side Cooled</b>				
$I_{T(AV)}$	Mean on-state current	Half wave resistive load	1560	A
$I_{T(RMS)}$	RMS value	-	2450	A
$I_T$	Continuous (direct) on-state current	-	2210	A

## SURGE RATINGS

Symbol	Parameter	Test Conditions	Max.	Units
$I_{TSM}$	Surge (non-repetitive) on-state current	10ms half sine, $T_{case} = 125^{\circ}\text{C}$	24.0	kA
$I^2t$	$I^2t$ for fusing	$V_R = 0$	2.88	$\text{MA}^2\text{s}$

## THERMAL AND MECHANICAL RATINGS

Symbol	Parameter	Test Conditions	Min.	Max.	Units
$R_{th(j-c)}$	Thermal resistance – junction to case	Double side cooled      DC	-	0.02	$^{\circ}\text{C/W}$
$R_{th(c-h)}$	Thermal resistance – case to heatsink	Double side cooled      DC	-	0.005	$^{\circ}\text{C/W}$
$T_{vj}$	Virtual junction temperature	Blocking $V_{DRM}/V_{RRM}$	-	125	$^{\circ}\text{C}$
$T_{stg}$	Storage temperature range		-40	140	$^{\circ}\text{C}$
$F_m$	Clamping force		18	26	kN

## DYNAMIC CHARACTERISTICS

Symbol	Parameter	Test Conditions	Min.	Max.	Units	
$I_{RRM}/I_{DRM}$	Peak reverse and off-state current	At $V_{RRM}/V_{DRM}$ , $T_{case} = 125^{\circ}C$	-	150	mA	
$dV/dt$	Max. linear rate of rise of off-state voltage	To 67% $V_{DRM}$ , $T_j = 125^{\circ}C$ , gate open	1000	-	V/ $\mu s$	
$dI/dt$	Rate of rise of on-state current	From 67% $V_{DRM}$ to 2000A	Repetitive 50Hz	-	200	A/ $\mu s$
		Gate source 30V, 10 $\Omega$ , $t_r < 0.5\mu s$ , $T_j = 125^{\circ}C$	Non-repetitive	-	1000	A/ $\mu s$
$V_T$	On-state voltage	$I_T = 1500A$ , $T_{case} = 125^{\circ}C$		1.30	V	
$V_{T(TO)}$	Threshold voltage – Low level	$T_{case} = 125^{\circ}C$	-	0.89	V	
$r_T$	On-state slope resistance – Low level	$T_{case} = 125^{\circ}C$	-	0.27	m $\Omega$	
$t_{gd}$	Delay time	$V_D = 67\% V_{DRM}$ , gate source 30V, 10 $\Omega$ $t_r = 0.5\mu s$ , $T_j = 25^{\circ}C$	-	3.0	$\mu s$	
$t_q$	Turn-off time	$T_j = 125^{\circ}C$ , $V_R = 100V$ , $dI/dt = 10A/\mu s$ , $dV_{DR}/dt = 20V/\mu s$ linear to 67% $V_{DRM}$	-	300	$\mu s$	
$Q_S$	Stored charge	$I_T = 2000A$ , $t_p = 1000\mu s$ , $T_j = 125^{\circ}C$ , $dI/dt = 10A/\mu s$ ,	-	3200	$\mu C$	
$I_{RR}$	Reverse recovery current		-	160	A	
$I_L$	Latching current	$T_j = 25^{\circ}C$ ,	-	1	A	
$I_H$	Holding current	$T_j = 25^{\circ}C$ ,	-	200	mA	

## GATE TRIGGER CHARACTERISTICS AND RATINGS

Symbol	Parameter	Test Conditions	Max.	Units
$V_{GT}$	Gate trigger voltage	$V_{DRM} = 5V$ , $T_{case} = 25^{\circ}C$	3	V
$V_{GD}$	Gate non-trigger voltage	At 40% $V_{DRM}$ , $T_{case} = 125^{\circ}C$	0.3	V
$I_{GT}$	Gate trigger current	$V_{DRM} = 5V$ , $T_{case} = 25^{\circ}C$	300	mA
$I_{GD}$	Gate non-trigger current	At 40% $V_{DRM}$ , $T_{case} = 125^{\circ}C$	20	mA

CURVES

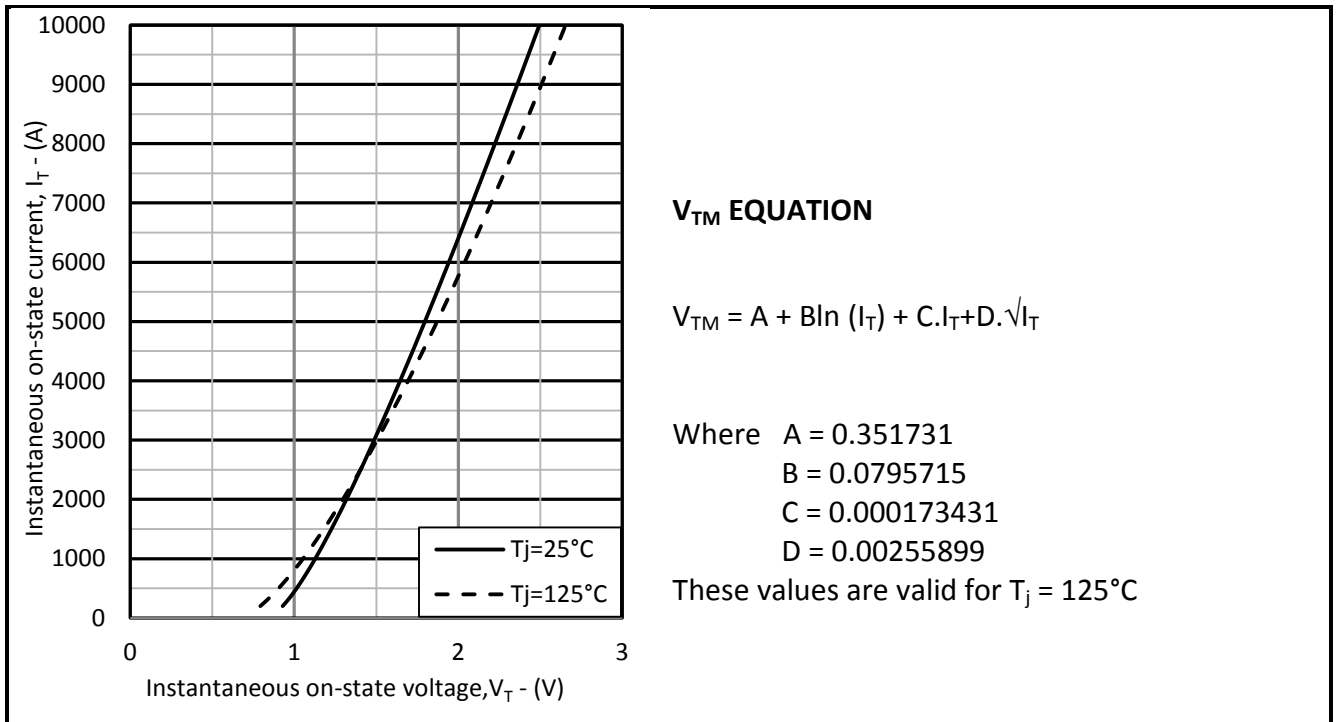

Fig.2 Maximum & minimum on-state characteristics

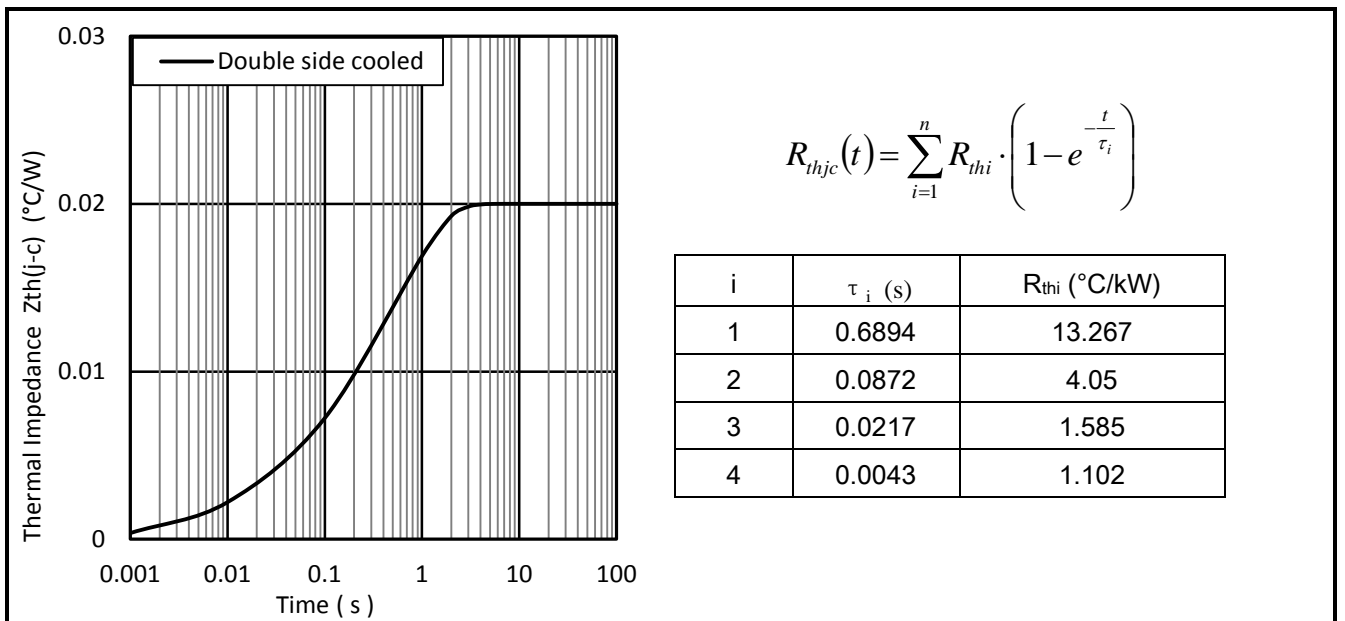

Fig.3 Maximum (limit) transient thermal impedance – junction to case (°C/W)

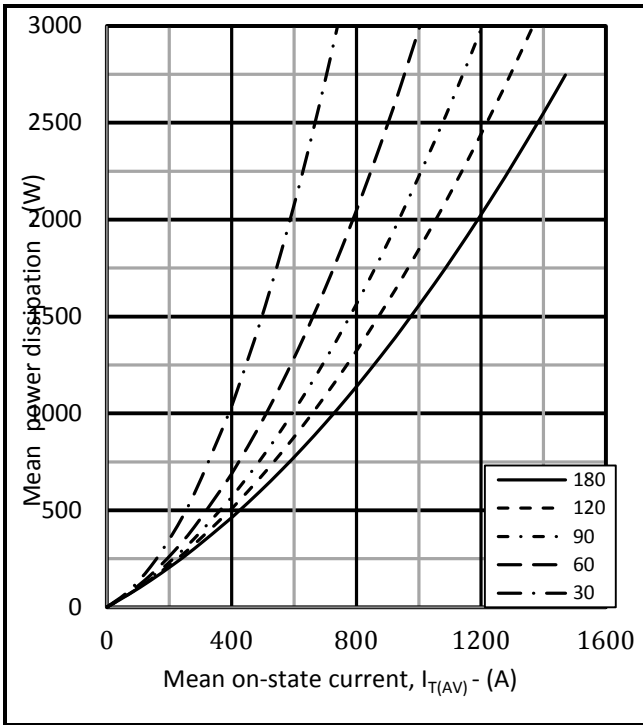

Fig.4 On-state power dissipation – sine wave

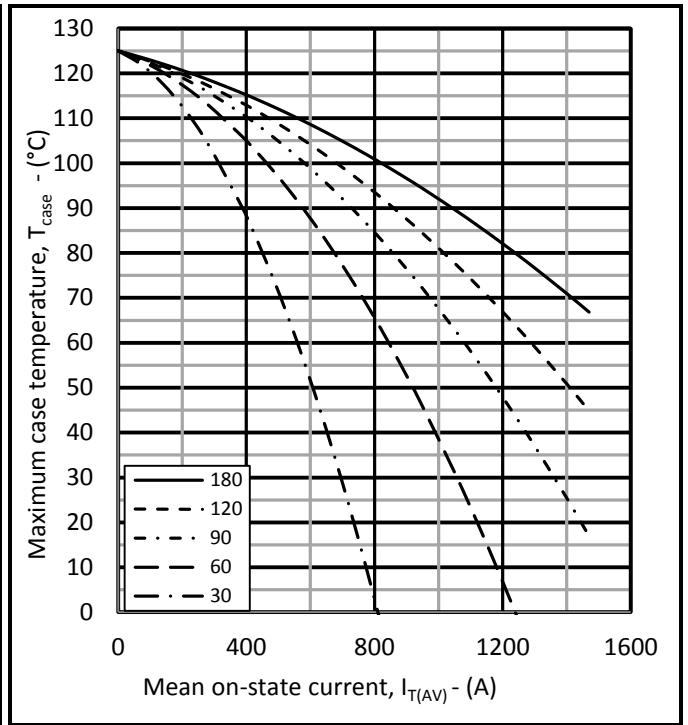

Fig.5 Maximum permissible case temperature, double side cooled – sine wave

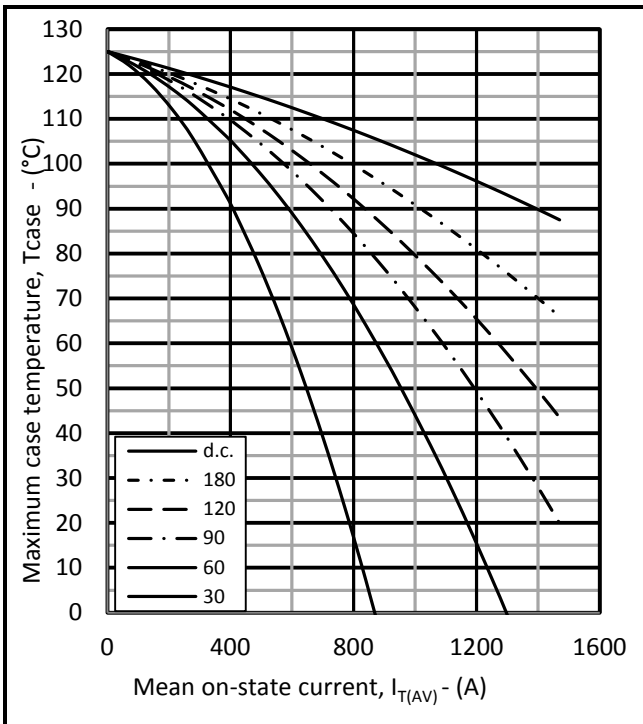

Fig.6 Maximum permissible case temperature, double side cooled – rectangular wave

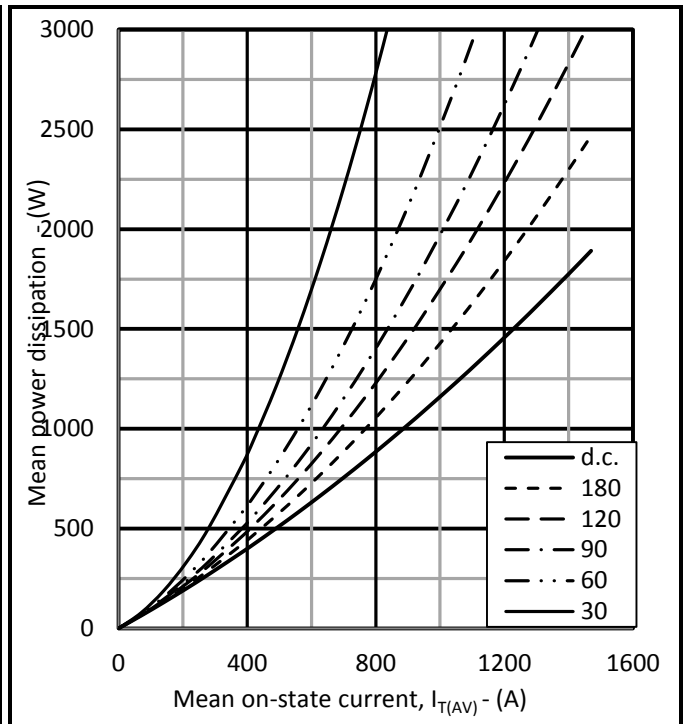

Fig.7 On-state power dissipation – rectangular wave

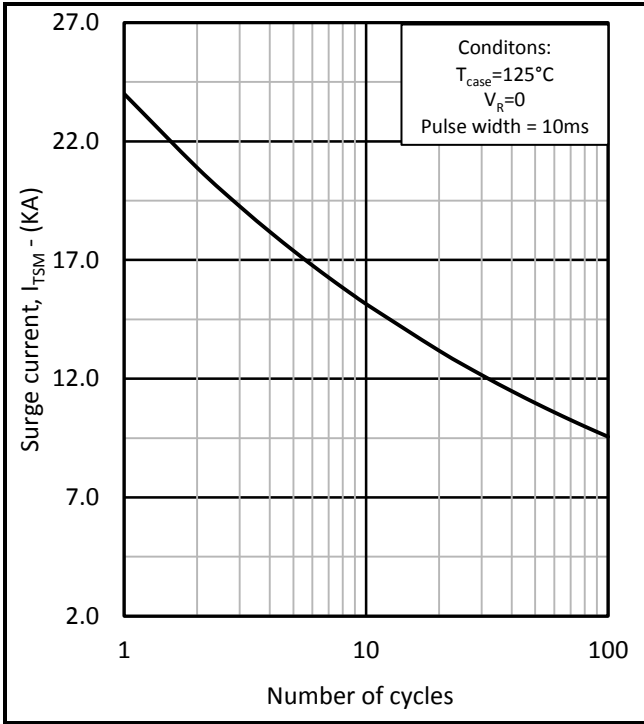

Fig.8 Multi-cycle surge current

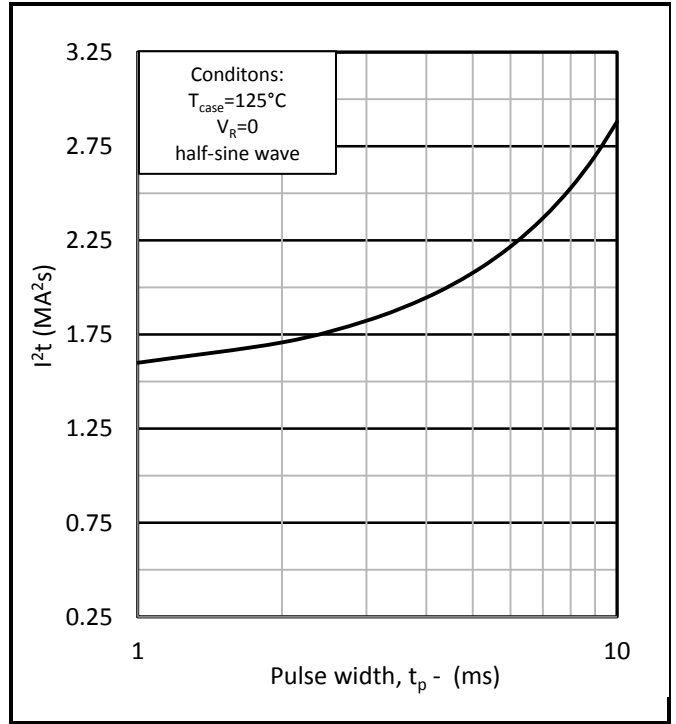

Fig.9 Single-cycle  $I^2t$

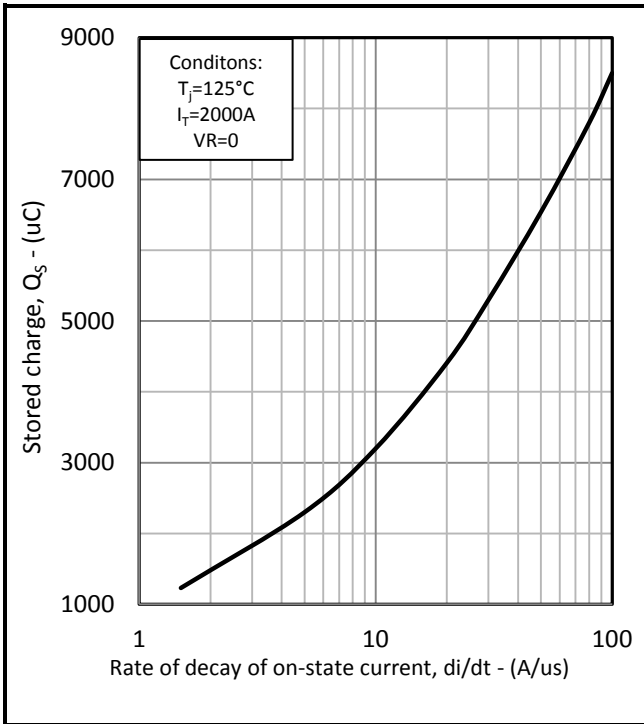

Fig.10 Stored charge vs  $di/dt$

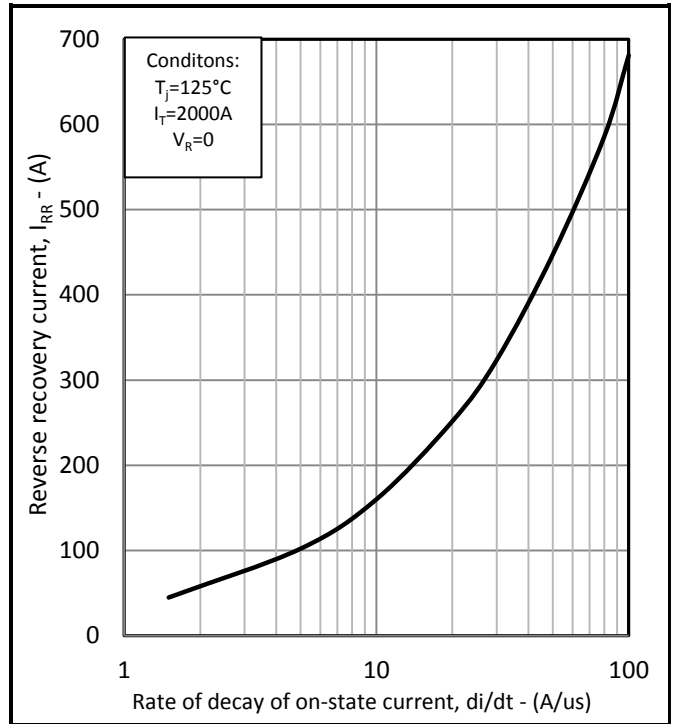

Fig.11 Reverse recovery current vs  $di/dt$

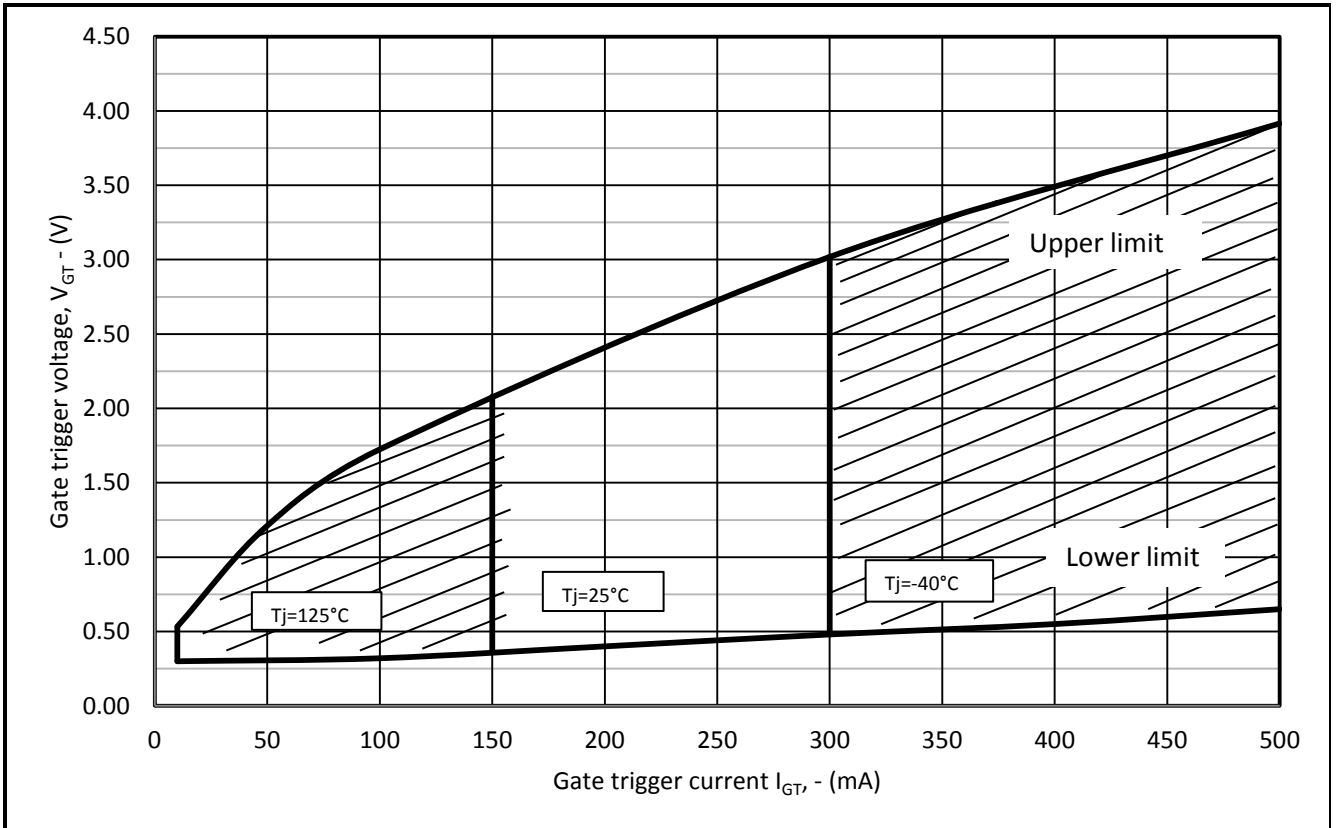

Fig.12 Gate characteristics

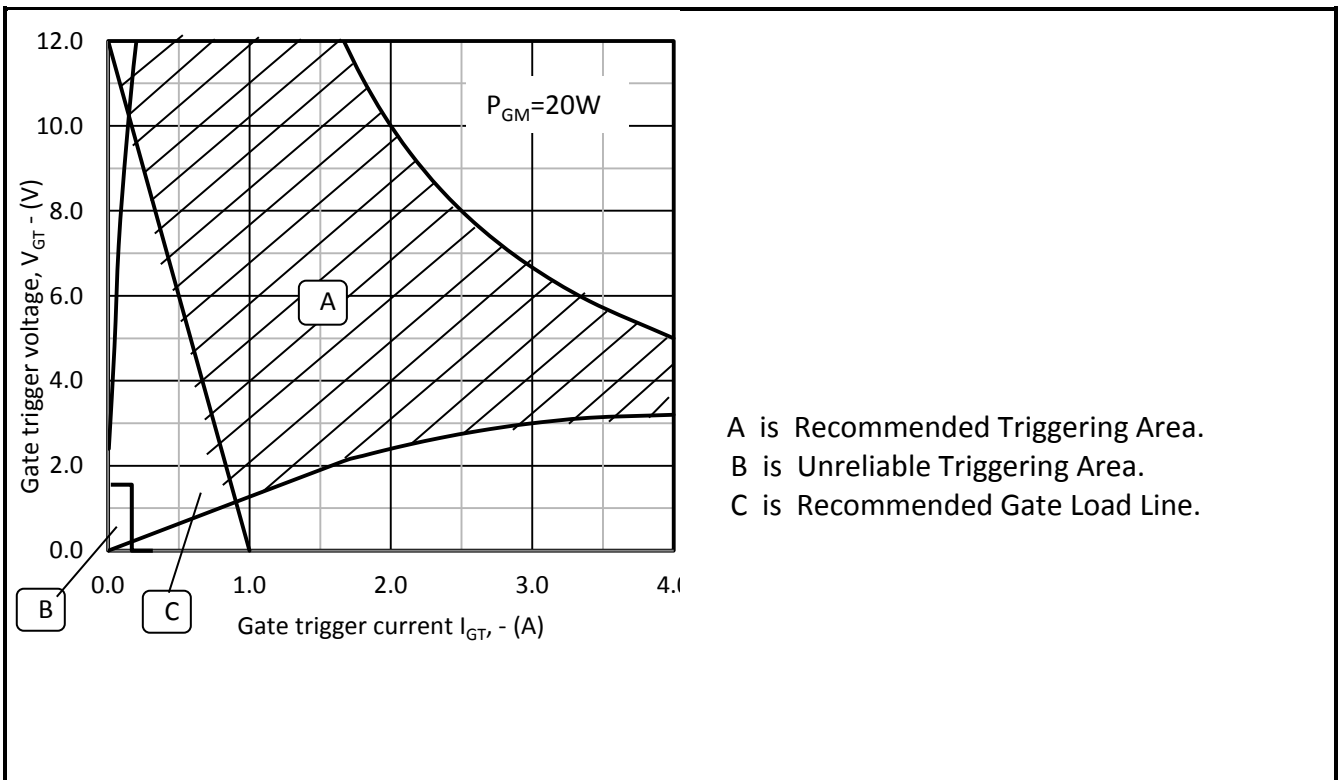

Fig.13 Gate characteristics

PACKAGE DETAILS

For further package information, please contact Customer Services. All dimensions in mm, unless stated otherwise. DO NOT SCALE.

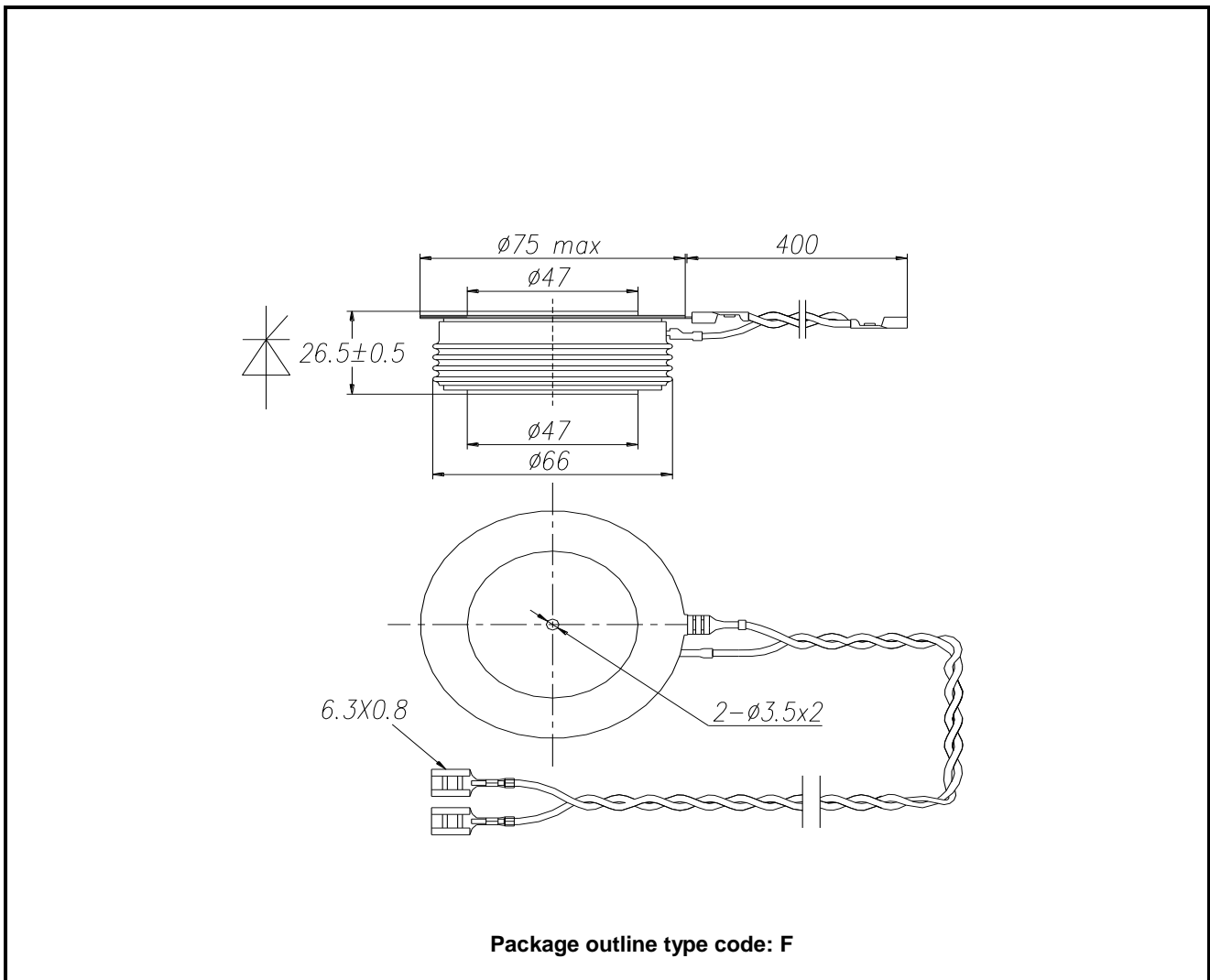

Fig.14 Package outline



**IMPORTANT INFORMATION:**

This publication is provided for information only and not for resale.

The products and information in this publication are intended for use by appropriately trained technical personnel.

Due to the diversity of product applications, the information contained herein is provided as a general guide only and does not constitute any guarantee of suitability for use in a specific application. The user must evaluate the suitability of the product and the completeness of the product data for the application. The user is responsible for product selection and ensuring all safety and any warning requirements are met. Should additional product information be needed please contact Customer Service.

Although we have endeavoured to carefully compile the information in this publication it may contain inaccuracies or typographical errors. The information is provided without any warranty or guarantee of any kind.

This publication is an uncontrolled document and is subject to change without notice. When referring to it please ensure that it is the most up to date version and has not been superseded.

The products are not intended for use in applications where a failure or malfunction may cause loss of life, injury or damage to property. The user must ensure that appropriate safety precautions are taken to prevent or mitigate the consequences of a product failure or malfunction.

The products must not be touched when operating because there is a danger of electrocution or severe burning. Always use protective safety equipment such as appropriate shields for the product and wear safety glasses. Even when disconnected any electric charge remaining in the product must be discharged and allowed to cool before safe handling using protective gloves.

Extended exposure to conditions outside the product ratings may affect reliability leading to premature product failure. Use outside the product ratings is likely to cause permanent damage to the product. In extreme conditions, as with all semiconductors, this may include potentially hazardous rupture, a large current to flow or high voltage arcing, resulting in fire or explosion. Appropriate application design and safety precautions should always be followed to protect persons and property.

**Product Status & Product Ordering:**

We annotate datasheets in the top right hand corner of the front page, to indicate product status if it is not yet fully approved for production. The annotations are as follows:-

<b>Target Information:</b>	This is the most tentative form of information and represents a very preliminary specification. No actual design work on the product has been started.
<b>Preliminary Information:</b>	The product design is complete and final characterisation for volume production is in progress. The datasheet represents the product as it is now understood but details may change.
<b>No Annotation:</b>	The product has been approved for production and unless otherwise notified by Dynex any product ordered will be supplied to the <b>current version of the data sheet prevailing at the time of our order acknowledgement.</b>

All products and materials are sold and services provided subject to Dynex's conditions of sale, which are available on request.

Any brand names and product names used in this publication are trademarks, registered trademarks or trade names of their respective owners.

**HEADQUARTERS OPERATIONS**

DYNEX SEMICONDUCTOR LIMITED  
 Doddington Road, Lincoln, Lincolnshire, LN6 3LF  
 United Kingdom.  
 Phone: +44 (0) 1522 500500  
 Web: <http://www.dynexsemi.com>

**CUSTOMER SERVICE**

Phone: +44 (0) 1522 502753 / 502901  
 e-mail: [powersolutions@dynexsemi.com](mailto:powersolutions@dynexsemi.com)