

### FEATURES

- Double Side Cooling
- High Surge Capability

### APPLICATIONS

- Crowbar
- High Power Drives
- High Voltage Power Supplies
- Static Switches

### VOLTAGE RATINGS

Part and Ordering Number	Repetitive Peak Voltages $V_{DRM}$ and $V_{RRM}$ (V)	Conditions
DCR4500A42*	4200	$T_{vj} = -40^{\circ}\text{C}$ to $125^{\circ}\text{C}$ , $I_{DRM} = I_{RRM} = 300\text{mA}$ , $V_{DRM}, V_{RRM} t_p = 10\text{ms}$ $V_{DSM} \& V_{RSM} =$ $V_{DRM} \& V_{RRM} + 100\text{V}$ respectively
DCR4500A40	4000	
DCR4500A36	3600	

Lower voltage grades available.

\*4100V @  $-40^{\circ}\text{C}$ , 4200V @  $0^{\circ}\text{C}$

### KEY PARAMETERS

$V_{DRM}$	<b>4200V</b>
$I_{T(AV)}$	<b>4450A</b>
$I_{TSM}$	<b>60000A</b>
$dV/dt^*$	<b>2000V/<math>\mu\text{s}</math></b>
$dI/dt$	<b>500A/<math>\mu\text{s}</math></b>

\* Higher  $dV/dt$  selections are available on request

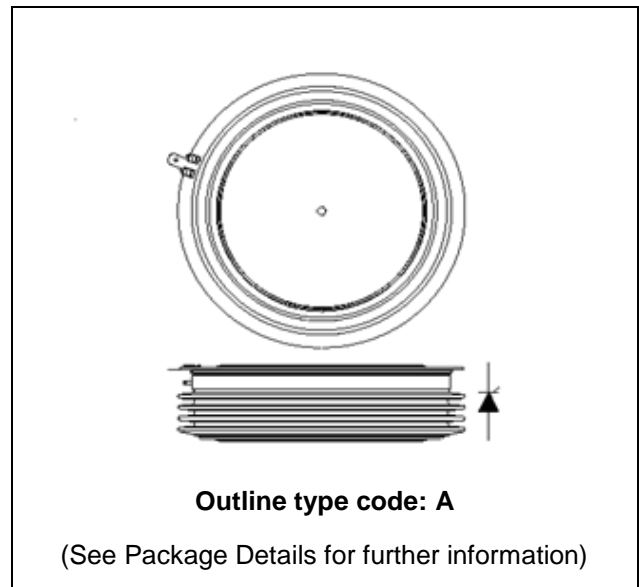

Fig. 1 Package outline

### ORDERING INFORMATION

When ordering, select the required part number shown in the Voltage Ratings selection table.

For example:

#### DCR4500A42

Note: Please use the complete part number when ordering and quote this number in any future correspondence relating to your order.

## CURRENT RATINGS

$T_{case} = 60^{\circ}\text{C}$  unless stated otherwise

Symbol	Parameter	Test Conditions	Max.	Units
<b>Double Side Cooled</b>				
$I_{T(AV)}$	Mean on-state current	Half wave resistive load	4450	A
$I_{T(RMS)}$	RMS value	-	6990	A
$I_r$	Continuous (direct) on-state current	-	6270	A

## SURGE RATINGS

Symbol	Parameter	Test Conditions	Max.	Units
$I_{TSM}$	Surge (non-repetitive) on-state current	10ms half sine, $T_{case} = 125^{\circ}\text{C}$ $V_R = 0$	60.0	kA
$I^2t$	$I^2t$ for fusing		18.0	MA <sup>2</sup> s

## THERMAL AND MECHANICAL RATINGS

Symbol	Parameter	Test Conditions		Min.	Max.	Units
$R_{th(j-c)}$	Thermal resistance - junction to case	Double side cooled	DC	-	6.0	$^{\circ}\text{C}/\text{kW}$
		Single side cooled	Anode DC	-	10.4	$^{\circ}\text{C}/\text{kW}$
			Cathode DC	-	14.9	$^{\circ}\text{C}/\text{kW}$
$R_{th(c-h)}$	Thermal resistance - case to heatsink	Clamping force 83kN (with mounting compound)	Double side	-	1.0	$^{\circ}\text{C}/\text{kW}$
			Single side	-	2.0	$^{\circ}\text{C}/\text{kW}$
$T_{vj}$	Virtual junction temperature	Blocking $V_{DRM} / V_{RRM}$		-	125	$^{\circ}\text{C}$
$T_{stg}$	Storage temperature range			-55	125	$^{\circ}\text{C}$
$F_m$	Clamping force			74	91	kN

**DYNAMIC CHARACTERISTICS**

Symbol	Parameter	Test Conditions	Typ.	Max.	Units
<b>I<sub>RRM</sub>/I<sub>DRM</sub></b>	Peak reverse and off-state current	At $V_{RRM}/V_{DRM}$ , $T_{case} = 125^{\circ}C$	-	300	mA
		At 50% $V_{RRM}/V_{DRM}$ , $T_{case} = 125^{\circ}C$	20	-	mA

Symbol	Parameter	Test Conditions	Min.	Max.	Units	
<b>V<sub>TM</sub></b>	Instantaneous forward voltage	At 4000A peak, $T_j = 125^{\circ}C$	1.30	1.45	V	
<b>dV/dt</b>	Max. linear rate of rise of off-state voltage	To 67% $V_{DRM}$ , $T_j = 125^{\circ}C$ , gate open	-	2000	V/ $\mu$ s	
<b>dI/dt</b>	Rate of rise of on-state current	From 67% $V_{DRM}$ to $2x I_{T(AV)}$ Gate source 30V, 10 $\Omega$ $t_r < 0.5\mu$ s, $T_j = 125^{\circ}C$	Repetitive 50Hz	-	200	A/ $\mu$ s
			Non-repetitive	-	500	A/ $\mu$ s
<b>V<sub>T(ro)</sub></b>	Threshold voltage - Low level	500A to 3400A at $T_{case} = 125^{\circ}C$	-	0.81	V	
	Threshold voltage - High level	3400A to 9000A at $T_{case} = 125^{\circ}C$	-	0.98	V	
<b>r<sub>T</sub></b>	On-state slope resistance - Low level	500A to 3400A at $T_{case} = 125^{\circ}C$	-	0.17	m $\Omega$	
	On-state slope resistance - High level	3400A to 9000A at $T_{case} = 125^{\circ}C$	-	0.12	m $\Omega$	
<b>t<sub>gd</sub></b>	Delay time	$V_D = 67\% V_{DRM}$ , gate source 30V, 10 $\Omega$ $t_r = 0.5\mu$ s, $T_j = 25^{\circ}C$	-	3	$\mu$ s	
<b>t<sub>q</sub></b>	Turn-off time	$I_T = 5000A$ , $T_j = 125^{\circ}C$ , $V_R = 200V$ , $dI/dt = 5A/\mu$ s, $dV_{DR}/dt = 20V/\mu$ s linear	-	900	$\mu$ s	
<b>Q<sub>s</sub></b>	Stored charge	$I_T = 1700A$ , $T_j = 125^{\circ}C$ , $dI/dt = 1A/\mu$ s,	2570	5350	$\mu$ C	
<b>I<sub>RR</sub></b>	Reverse recovery current	$V_R \sim 1700V$ , $C_s = 1\mu$ F, $R_s = 63\Omega$	42	68	A	
<b>I<sub>L</sub></b>	Latching current	$T_j = 25^{\circ}C$ , $V_D = 5V$	-	3	A	
<b>I<sub>H</sub></b>	Holding current	$T_j = 25^{\circ}C$ , $R_{G-K} = \infty$ , $I_{TM} = 500A$ , $I_T = 5A$	-	300	mA	

## GATE TRIGGER CHARACTERISTICS AND RATINGS

Symbol	Parameter	Test Conditions	Max.	Units
$V_{GT}$	Gate trigger voltage	$V_{DRM} = 5V, T_{case} = 25^{\circ}C$	1.5	V
$V_{GD}$	Gate non-trigger voltage	At 50% $V_{DRM}, T_{case} = 125^{\circ}C$	0.4	V
$I_{GT}$	Gate trigger current	$V_{DRM} = 5V, T_{case} = 25^{\circ}C$	400	mA
$I_{GD}$	Gate non-trigger current	At 50% $V_{DRM}, T_{case} = 125^{\circ}C$	10	mA

## CURVES

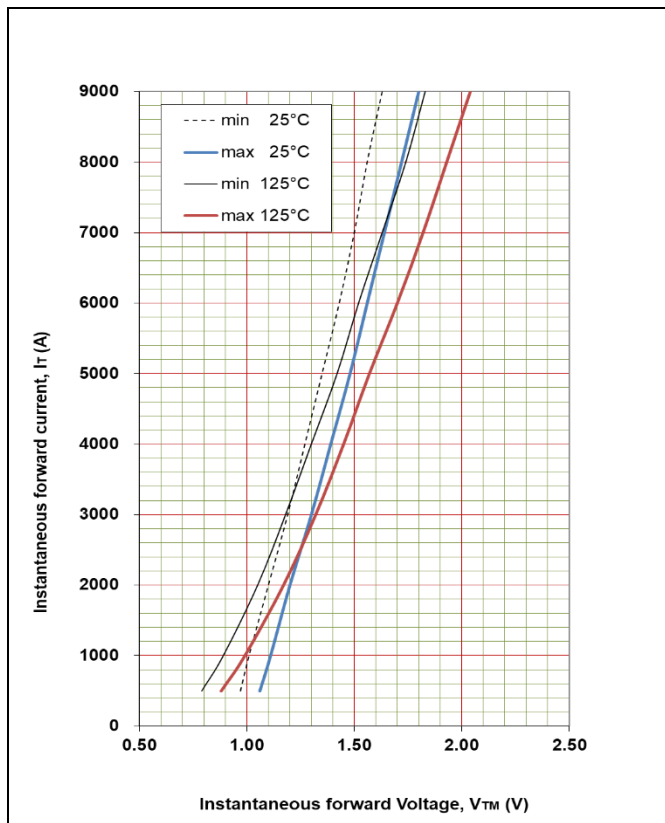

Fig. 2 Maximum & minimum on-state characteristics

## $V_{TM}$ EQUATION

$$V_{TM} = A + B \cdot \ln(I_T) + C \cdot I_T + D \cdot \sqrt{I_T}$$

Where  $A = 0.090451$

$B = 0.121408$

$C = 0.000109$

$D = -0.001368$

These values are valid for  $T_j = 125^{\circ}C$  for  $I_T$  500A to 9000A

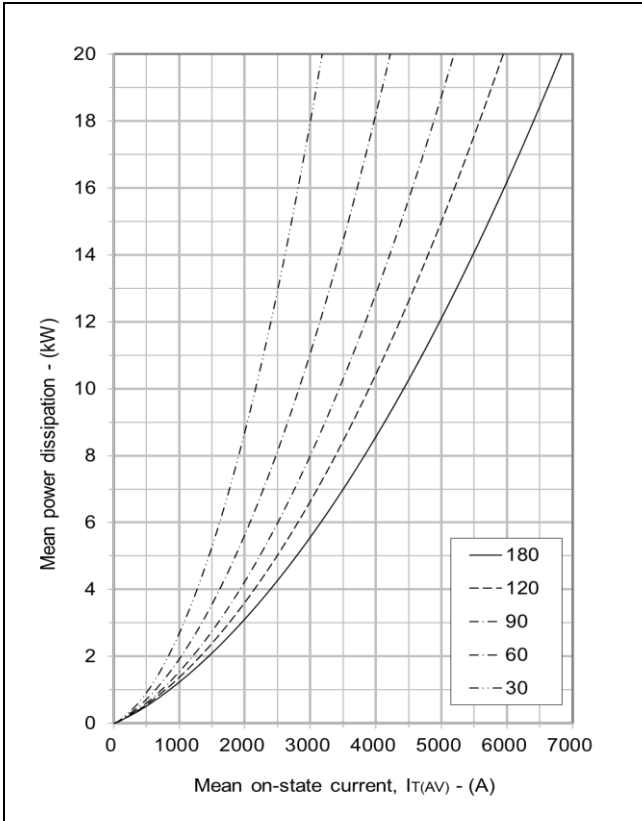

Fig. 3 On-state power dissipation - sine wave

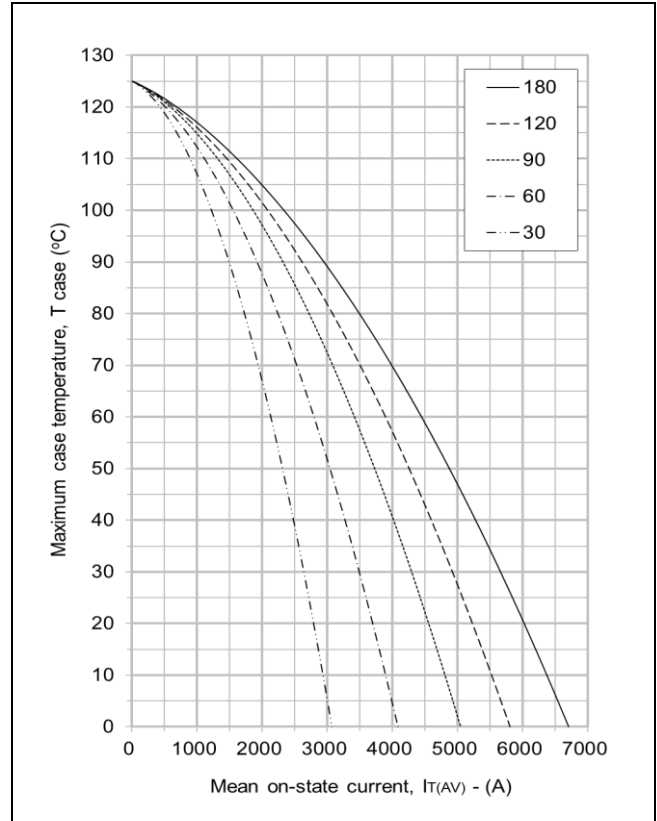

Fig. 4 Maximum permissible case temperature, double side cooled - sine wave

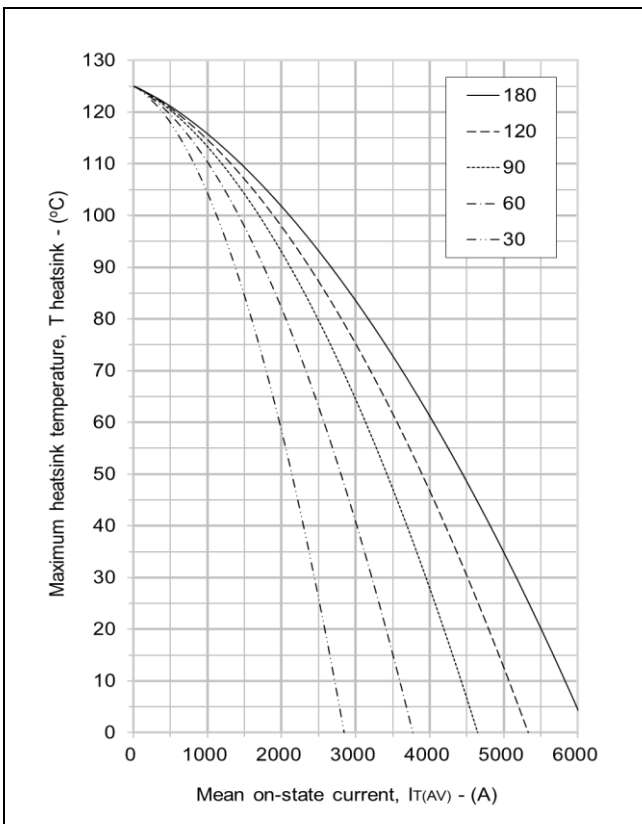

Fig. 5 Maximum permissible heatsink temperature, double side cooled - sine wave

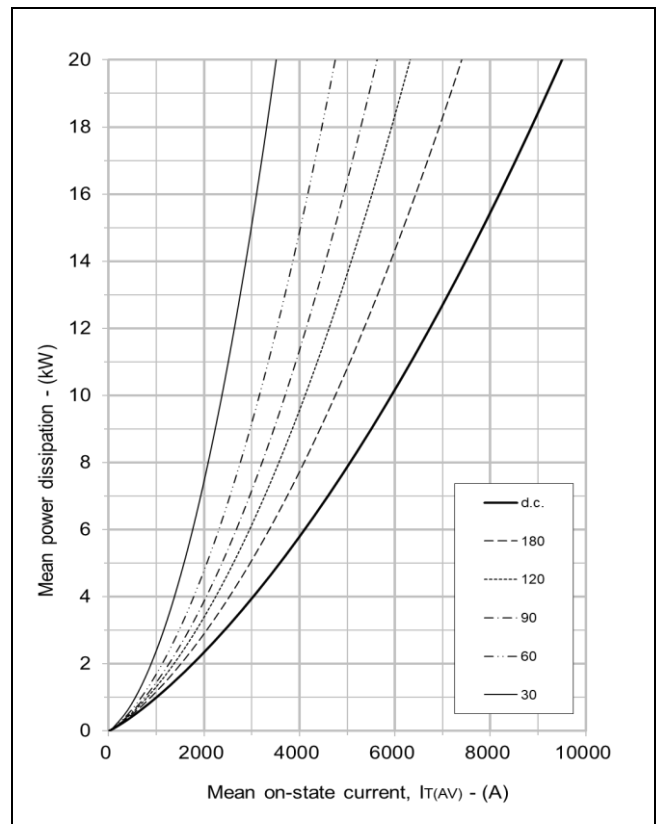

Fig. 6 On-state power dissipation - rectangular wave

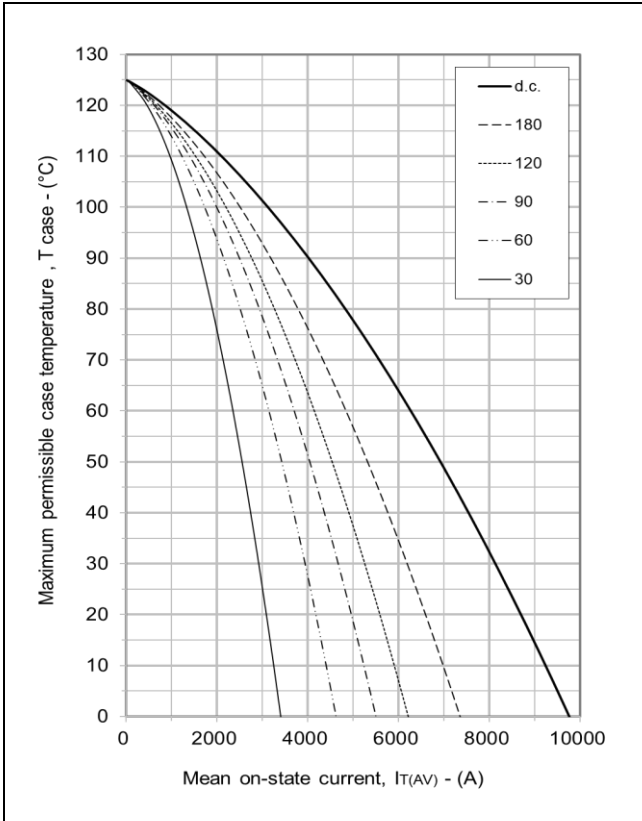

Fig. 7 Maximum permissible case temperature, double side cooled - rectangular wave

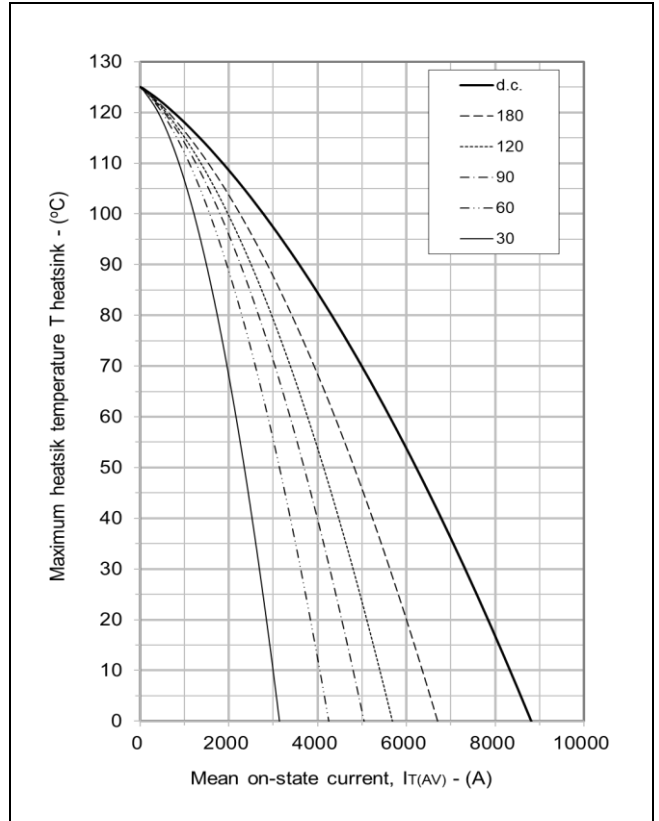

Fig. 8 Maximum permissible heatsink temperature, double side cooled - rectangular wave

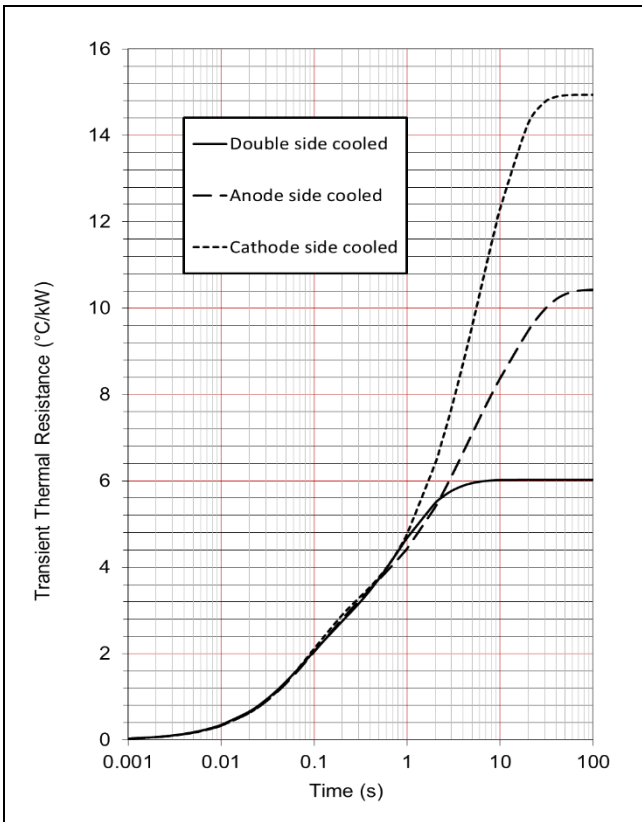

Fig.9 Maximum (limit) transient thermal impedance – junction to case (degC/kW)

		1	2	3	4
Double side cooled	Ri(°C/kW)	3.015	1.049	0.984	0.984
	Ti(s)	0.704	1.905	0.059	0.059
Anode side cooled	Ri(°C/kW)	3.156	4.093	1.557	1.624
	Ti(s)	2.690	13.792	0.059	0.206
Cathode side cooled	Ri(°C/kW)	7.077	3.483	1.746	2.634
	Ti(s)	6.649	8.436	1.762	0.081

$$Z_{th} = \sum_{i=1}^{i=4} R_i \cdot \left(1 - \exp\left(-\frac{T}{T_i}\right)\right)$$

$\Delta R_{th(j-c)}$  Conduction

Tables show the increments of thermal resistance  $R_{th(j-c)}$  when the device operates at conduction angles other than d.c.

Double side cooling			Anode Side Cooling			Cathode Sided Cooling					
$\theta^\circ$	$\Delta Z_{th} (z)$		$\Delta Z_{th} (z)$		$\Delta Z_{th} (z)$		$\theta^\circ$	$\Delta Z_{th} (z)$			
	sine.	rect.	sine.	rect.	sine.	rect.		sine.	rect.		
180	0.44	0.31	0.42	0.30	180	0.42	0.30	180	0.42	0.30	
120	0.49	0.43	120	0.47	0.41	120	0.47	0.41	120	0.47	0.41
90	0.55	0.49	90	0.52	0.46	90	0.52	0.46	90	0.52	0.46
60	0.60	0.55	60	0.57	0.52	60	0.57	0.52	60	0.57	0.52
30	0.64	0.61	30	0.61	0.58	30	0.61	0.58	30	0.60	0.58
15	0.66	0.64	15	0.62	0.61	15	0.62	0.60	15	0.62	0.60

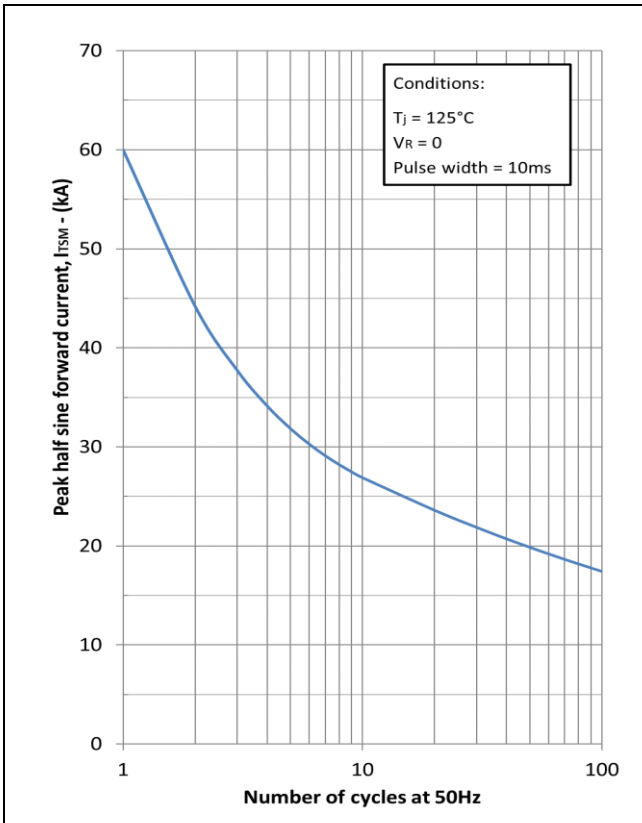

Fig. 10 Multi-cycle surge current

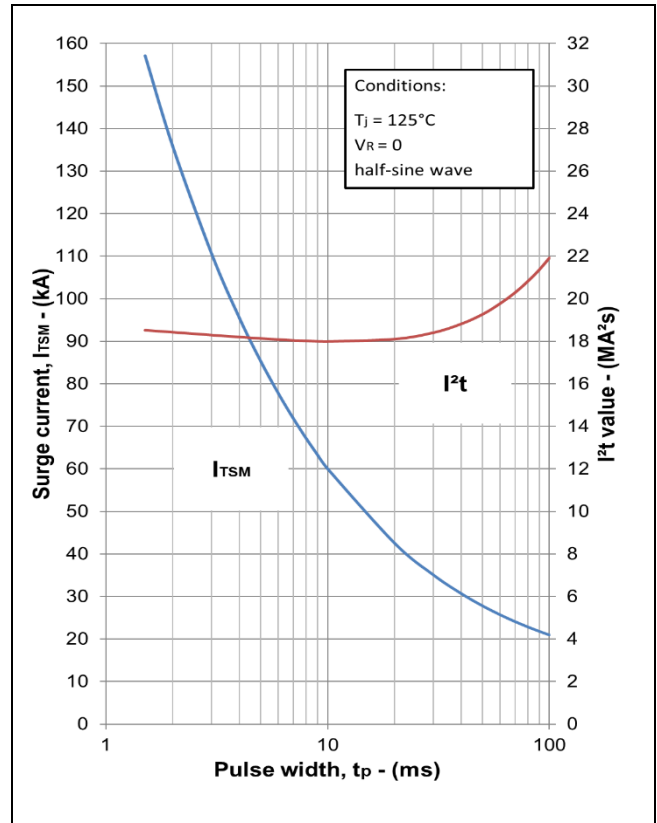

Fig. 11 Single-cycle surge current

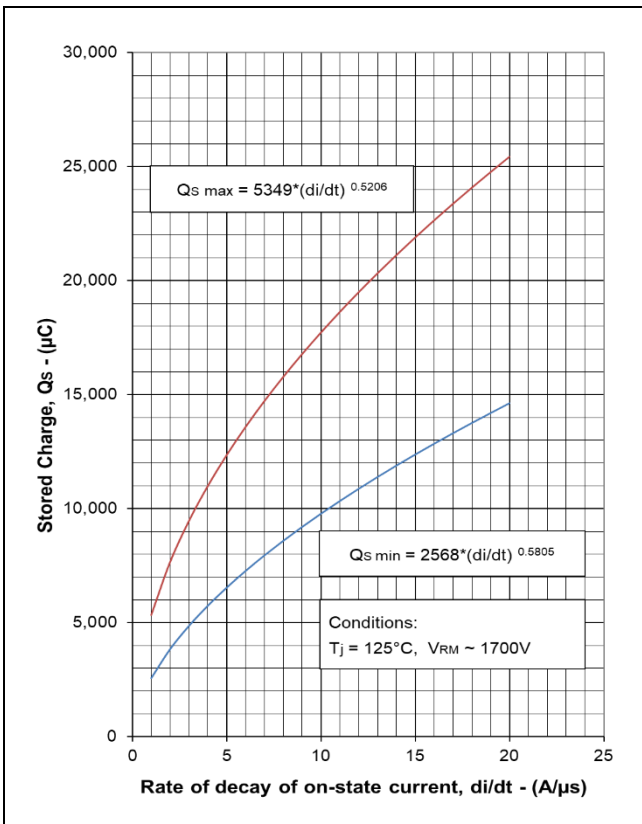

Fig. 12 Stored charge

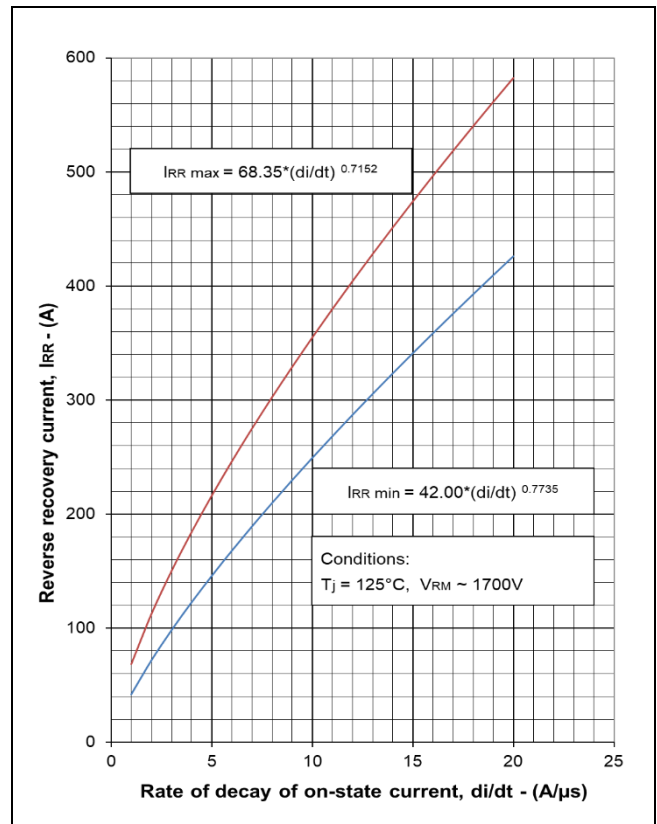

Fig. 13 Reverse recovery current

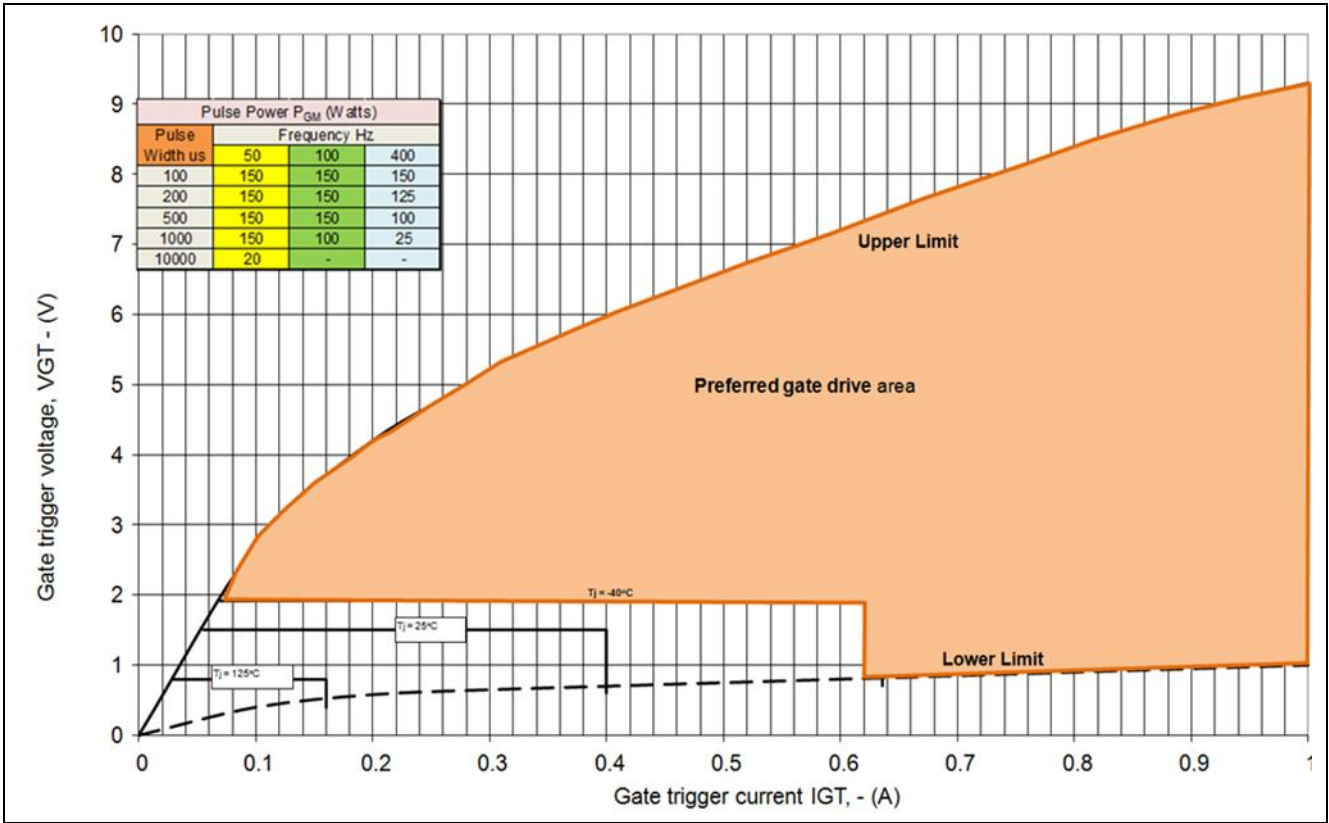

Fig.14 Gate characteristics

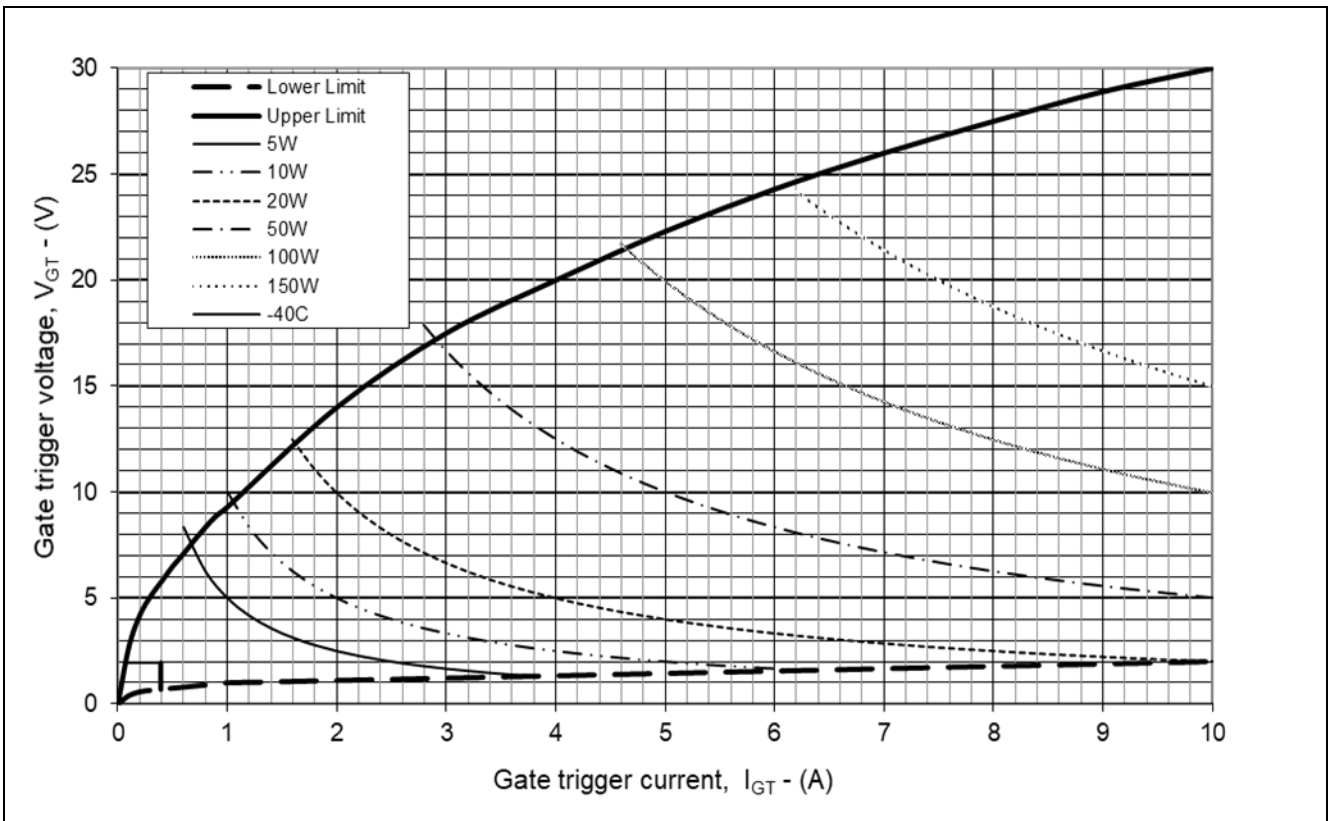

Fig. 15 Gate characteristics



**PACKAGE DETAILS**

For further package information, please contact Customer services.

All dimensions in mm, unless stated otherwise.

DO NOT SCALE

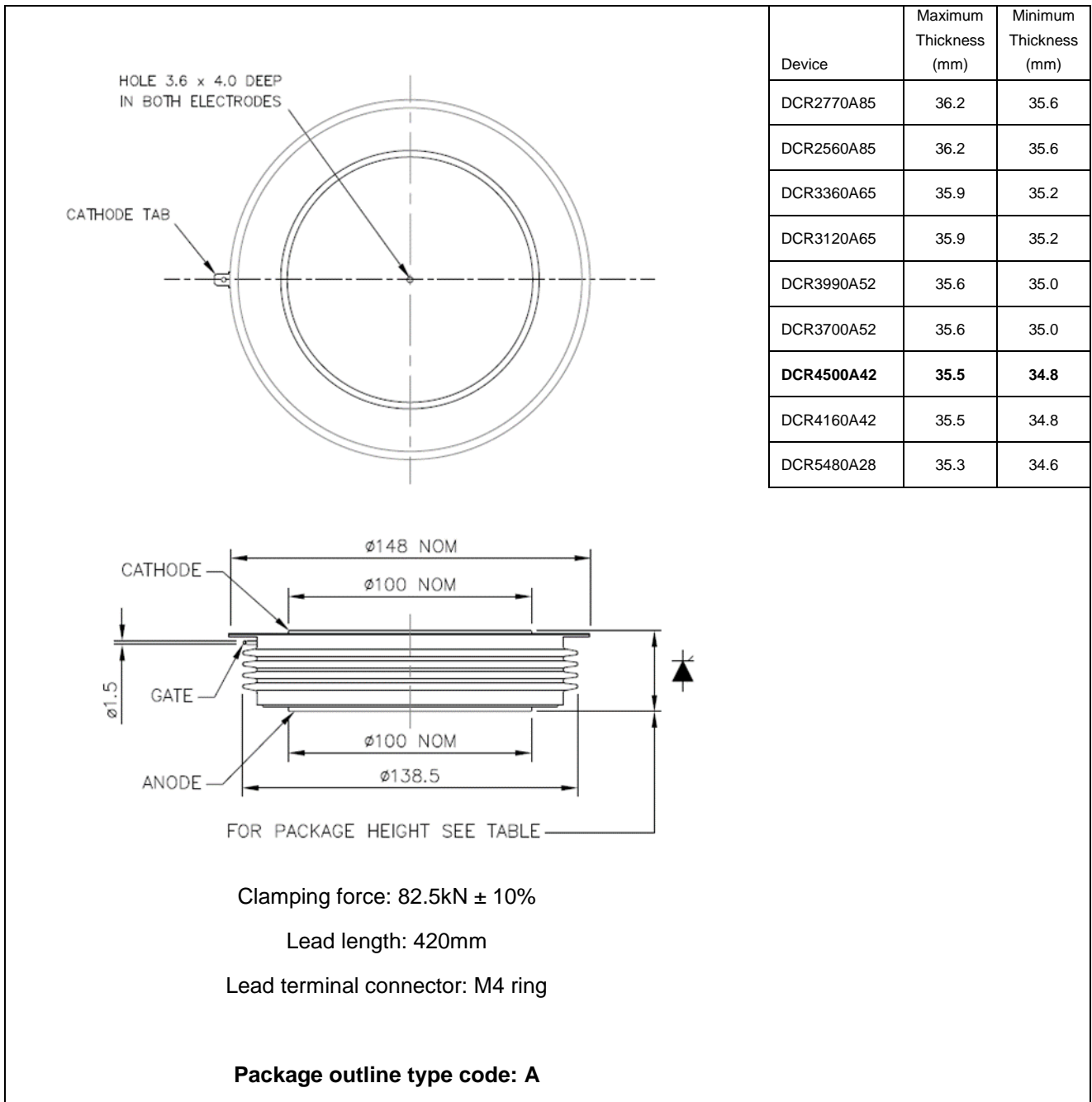

Fig. 16 Package outline

**IMPORTANT INFORMATION:**

This publication is provided for information only and not for resale.

The products and information in this publication are intended for use by appropriately trained technical personnel.

Due to the diversity of product applications, the information contained herein is provided as a general guide only and does not constitute any guarantee of suitability for use in a specific application. The user must evaluate the suitability of the product and the completeness of the product data for the application. The user is responsible for product selection and ensuring all safety and any warning requirements are met. Should additional product information be needed please contact Customer Service.

Although we have endeavoured to carefully compile the information in this publication it may contain inaccuracies or typographical errors. The information is provided without any warranty or guarantee of any kind.

This publication is an uncontrolled document and is subject to change without notice. When referring to it please ensure that it is the most up to date version and has not been superseded.

The products are not intended for use in applications where a failure or malfunction may cause loss of life, injury or damage to property. The user must ensure that appropriate safety precautions are taken to prevent or mitigate the consequences of a product failure or malfunction.

The products must not be touched when operating because there is a danger of electrocution or severe burning. Always use protective safety equipment such as appropriate shields for the product and wear safety glasses. Even when disconnected any electric charge remaining in the product must be discharged and allowed to cool before safe handling using protective gloves.

Extended exposure to conditions outside the product ratings may affect reliability leading to premature product failure. Use outside the product ratings is likely to cause permanent damage to the product. In extreme conditions, as with all semiconductors, this may include potentially hazardous rupture, a large current to flow or high voltage arcing, resulting in fire or explosion. Appropriate application design and safety precautions should always be followed to protect persons and property.

**Product Status & Product Ordering:**

We annotate datasheets in the top right hand corner of the front page, to indicate product status if it is not yet fully approved for production. The annotations are as follows:

<b>Target Information:</b>	This is the most tentative form of information and represents a very preliminary specification. No actual design work on the product has been started.
<b>Provisional Information:</b>	Some initial development work has been performed. The datasheet represents a view of the end product based on very limited information. Certain details will change.
<b>Preliminary Information:</b>	The product design is complete and final characterisation for volume production is in progress. The datasheet represents the product as it is now understood but details may change.
<b>No Annotation:</b>	The product has been approved for production and unless otherwise notified by Dynex any product ordered will be supplied to the <b>current version of the data sheet prevailing at the time of our order acknowledgement.</b>

All products and materials are sold and services provided subject to Dynex's conditions of sale, which are available on request.

Any brand names and product names used in this publication are trademarks, registered trademarks or trade names of their respective owners.

**HEADQUARTERS OPERATIONS**

DYNEX SEMICONDUCTOR LIMITED  
 Doddington Road, Lincoln, Lincolnshire. LN6 3LF  
 United Kingdom.  
 Phone: +44 (0) 1522 500500  
 Fax: +44 (0) 1522 500550  
 Web: <http://www.dynexsemi.com>

**CUSTOMER SERVICE**

Phone: +44 (0) 1522 502753 / 502901  
 e-mail: [powersolutions@dynexsemi.com](mailto:powersolutions@dynexsemi.com)