

Display Elektronik GmbH

DATA SHEET

TFT MODULE

**DEM 1024600K
TMH-PW-N**

10,1“ TFT

Product Specification

Ver.: 0

27.07.2018

Table of Contents

No.	Item	Page
1.	General Description	4
2.	Module Parameter.....	4
3.	Absolute Maximum Ratings	4
4.	DC Characteristics	5
5.	Backlight Characteristic.....	5
5.1.	Backlight Characteristic	5
5.2.	Backlighting circuit	5
6.	Optical Characteristics	6
6.1.	Optical Characteristics	6
6.2.	Definition of Response Time.....	6
6.3.	Definition of Contrast Ratio	7
6.4.	Definition of Viewing Angles	7
6.5.	Definition of Color Appearance	8
6.6.	Definition of Surface Luminance, Uniformity and Transmittance.....	8
7.	Block Diagram and Power Supply	9
8.	Interface Pins Definition	10
9.	AC characteristics	12
9.1.	LVDS mode AC electrical characteristics.....	12
9.2.	Data input format	13
9.3.	Parallel RGB input timing table.....	13
10.	Quality Assurance	14
10.1.	Purpose.....	14
10.2.	Standard for Quality Test	14
10.3.	Nonconforming Analysis & Disposition	14
F HYPERLINK \l "_Toc26782 10.4.	Agreement Items.....	14
10.5.	Standard of the Product Visual Inspection.....	15
10.6.	Inspection Specification	15
10.7.	Classification of Defects	19
10.8.	Identification/marketing criteria	19
10.9.	Packing	20
11.	Reliability Specification.....	21
12.	Precautions and Warranty.....	22
12.1.	Safety.....	22
12.2.	Handling.....	22
12.3.	Storage.....	22
12.4.	Metal Pin (Apply to Products with Metal Pins).....	22
12.5.	Operation	23
12.6.	Static Electricity.....	23
12.7.	Limited Warranty.....	23
13.	Outline Drawing.....	24

1. General Description

The specification is a transmissive type color active matrix liquid crystal display (LCD) which uses amorphous thin film transistor (TFT) as switching devices. This product is composed of a TFT-LCD panel, driver ICs and a backlight unit.

2. Module Parameter

Features	Details	Unit
Display Size (Diagonal)	10.1"	-
LCD Type	TN TFT	-
Display Mode	Transmissive / Normally White	-
Resolution	1024 x RGB x 600	Pixels
View Direction	12 O'CLOCK	Best Image
Gray Scale Inversion Direction	6 O'CLOCK	-
Module Outline	235.00 x 143.00 x 4.90 (Note 1)	mm
Active Area	222.72 x 125.28	mm
Pixel Pitch	0.2175 x 0.2088	um
Pixel Arrangement	RGB Vertical Stripe	-
Polarizer Surface Treatment	Anti-Glare	-
Display Colors	16.7 Million	-
Interface	LVDS Interface	-
Driver IC	HX8282-A01 & HX8696-A01	-
With or without the Touch Panel	No Touch	-
Operating Temperature	-20°C to +70°C	°C
Storage Temperature	-30°C to +80°C	°C
Weight	t.b.d.	g

Note 1: Inclusive hooks, posts, FFC/FPC tail etc.

3. Absolute Maximum Ratings

V_{SS}=0V, Ta=25°C

Item	Symbol	Min.	Max.	Unit
Supply Voltage	VDD	-0.5	+3.96	V
	AVDD	-0.5	+14.85	V
	VGH	-0.3	+42.0	V
	VGL	VGH-42	+0.3	V
Storage Temperature	T _{stg}	-30	+80	°C
Operating Temperature	T _{op}	-20	+70	°C

Note 1: If Ta below 50°C, the maximal humidity is 90%RH, if Ta over 50°C, absolute humidity should be less than 60%RH.

Note 2: The response time will be extremely slow when the operating temperature is around -10°C, and the back ground will become darker at high temperature operating.

4. DC Characteristics

Item	Symbol	Min.	Typ.	Max.	Unit
Supply Voltage	VDD	3.0	-	3.6	V
	AVDD	6.5	10.8	13.5	V
	VGH	(16)	21	(26)	V
	VGL	(-13)	-8	(-3)	V
Input Signal Voltage	VCOM	-	3.7	-	V
Logic Low Input Voltage	V _{IL}	0	-	0.3*DVDD	V
Logic High Input Voltage	V _{IH}	0.7*DVDD	-	DVDD	V
Logic Low Output Voltage	V _{OL}	-	-	GND+0.4	
Logic High Output Voltage	V _{OH}	DVDD-0.4	-	-	
Current Consumption (All Black)	I _{CC} + I _{IN}	-	t.b.d.	-	mA

Note 1: All of the voltage listed above are with respect to GND = 0V.

Note 2: Device is subject to be damaged permanently if stresses beyond those absolute maximum rating listed above

5. Backlight Characteristic

5.1. Backlight Characteristic

Item	Symbol	Condition	Min.	Typ.	Max.	Unit
Forward Voltage	V _F	T _a =25 °C, I _F =20mA/LED	8.4	9.4	10.2	V
Forward Current	I _F	T _a =25 °C, V _F =3.3V/LED	-	180	-	mA
Power Dissipation	P _D	-	-	1692	1836	mW
Uniformity	Avg	-	-	80	-	%
LED Lifetime (25°C)	-	-	20.000	30.000	-	Hrs
Drive Method	Constant Current					
LED Configuration	27 White LEDs (3 LEDs in one string and 9 groups in parallel)					

Note1: LED life time defined as follows: The final brightness is at 50% of original brightness.

The environmental conducted under ambient air flow, at T_a=25°C±2 °C, 60%RH±5%, I_F=20mA.

5.2. Backlighting Circuit

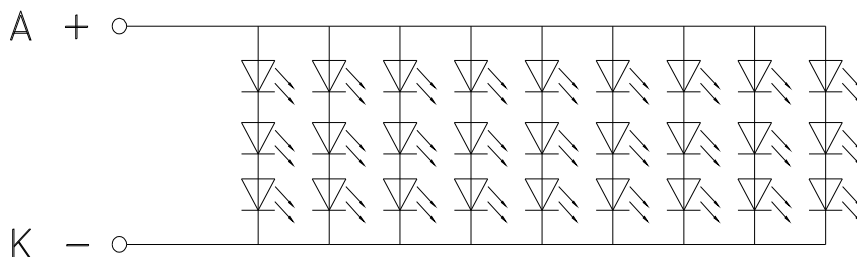

6. Optical Characteristics

6.1. Optical Characteristics

Ta=25°C, VDD=3.3V

	Item	Symbol	Condition	Specification			Unit	
				Min.	Typ.	Max.		
Backlight On (Transmissive Mode)	Luminance on TFT($I_f=20\text{mA/LED}$)	Lv		240	300	-	cd/m ²	
	Contrast Ratio(See 6.3)	CR		400	450	-		
	Response Time (See 6.2)	TR+TF		-	8	-	ms	
	Chromaticity Transmissive (See 6.5)	Red	XR	Center CR≥10	-	TBD	-	
			YR		-	TBD	-	
		Green	XG		-	TBD	-	
			YG		-	TBD	-	
		Blue	XB		-	TBD	-	
			YB		-	TBD	-	
	White	XW	-	TBD	-			
		YW	-	TBD	-			
	Viewing Angle (See 6.4)	Horizontal	θ_{x+}	Center CR≥10	60	70	-	Deg.
			θ_{x-}		60	70	-	
Vertical		ϕ_{y+}	50		60	-		
		ϕ_{y-}	60		70	-		
NTSC ratio (Color gamut)				-	52	-	%	

6.2. Definition of Response Time

6.2.1. Normally Black Type (Negative)

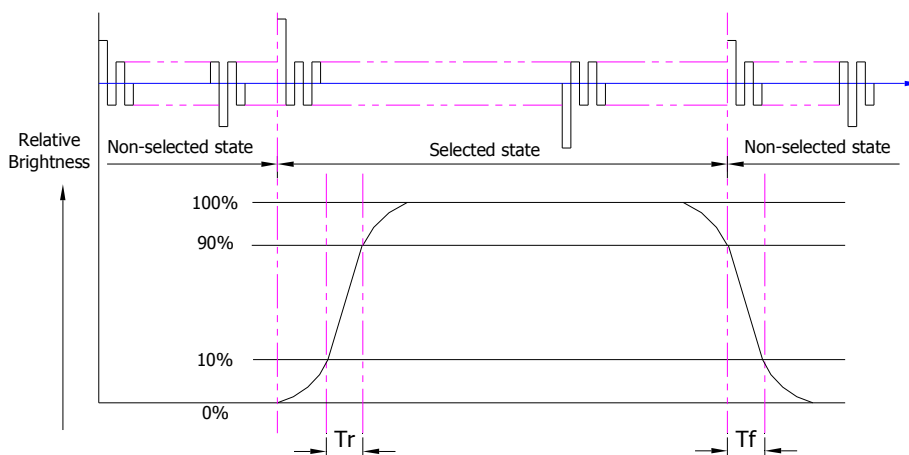

Tr is the time it takes to change from non-selected stage with relative luminance 10% to selected state with relative luminance 90%;

Tf is the time it takes to change from selected state with relative luminance 90% to non-selected state with relative luminance 10%.

Note: Measuring machine: LCD-5100

6.2.2. Normally White Type (Positive)

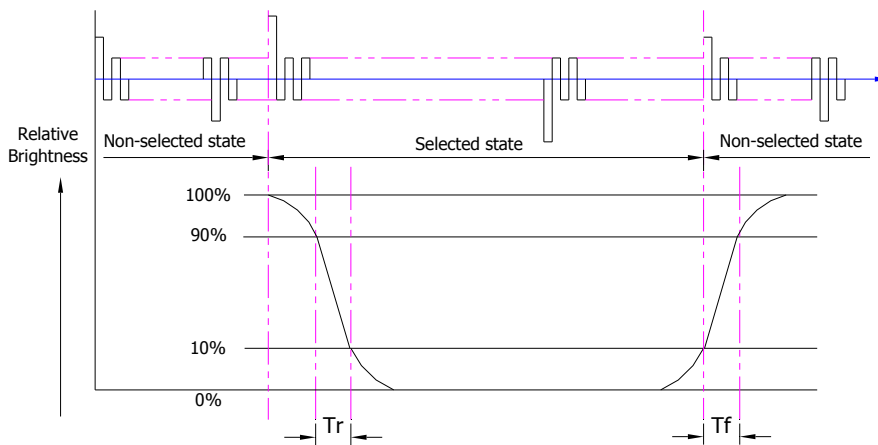

T_r is the time it takes to change from non-selected stage with relative luminance 90% to selected state with relative luminance 10%;

T_f is the time it takes to change from selected state with relative luminance 10% to non-selected state with relative luminance 90%;

Note: Measuring machine: LCD-5100 or EQUI

6.3. Definition of Contrast Ratio

Contrast is measured perpendicular to display surface in reflective and transmissive mode. The measurement condition is:

Measuring Equipment	Eldim or Equivalent
Measuring Point Diameter	3mm//1mm
Measuring Point Location	Active Area centre point
Test pattern	A: All Pixels white
	B: All Pixel black
Contrast setting	Maximum

Definitions: CR (Contrast) = Luminance of White Pixel / Luminance of Black Pixel

6.4. Definition of Viewing Angles

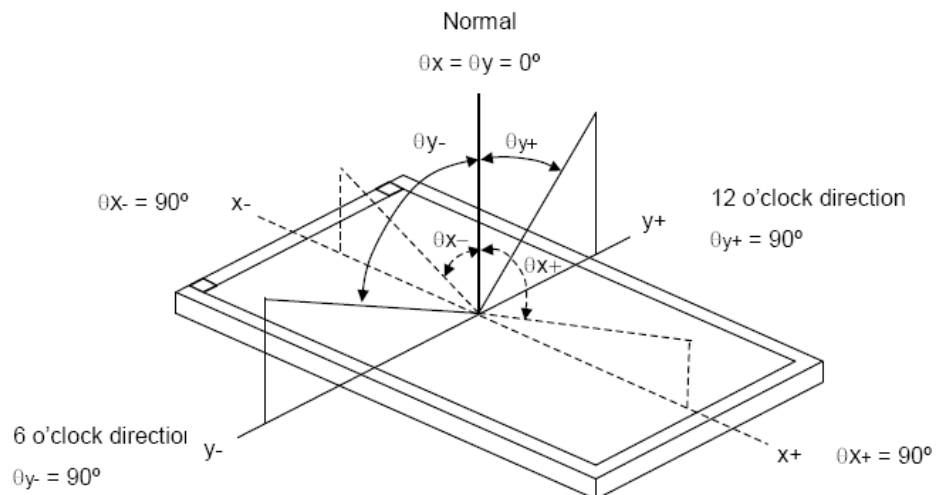

Measuring machine: LCD-5100 or EQUI

6.5. Definition of Color Appearance

R,G,B and W are defined by (x, y) on the IE chromaticity diagram

NTSC=area of RGB triangle/area of NTSC triangleX100%

Measuring picture: Red, Green, Blue and White (Measuring machine: BM-7)

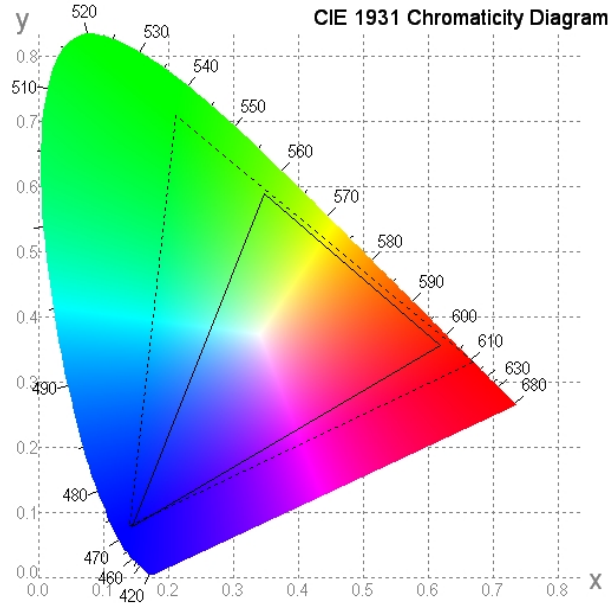

6.6. Definition of Surface Luminance, Uniformity and Transmittance

Using the transmissive mode measurement approach, measure the white screen luminance of the display panel and backlight.

- 6.6.1. Surface Luminance: $L_v = \text{average} (L_{P1}:L_{P9})$
- 6.6.2. Uniformity = $\text{Minimal} (L_{P1}:L_{P9}) / \text{Maximal} (L_{P1}:L_{P9}) * 100\%$
- 6.6.3. Transmittance = $L_v \text{ on LCD} / L_v \text{ on Backlight} * 100\%$

Note: Measuring machine: BM-7

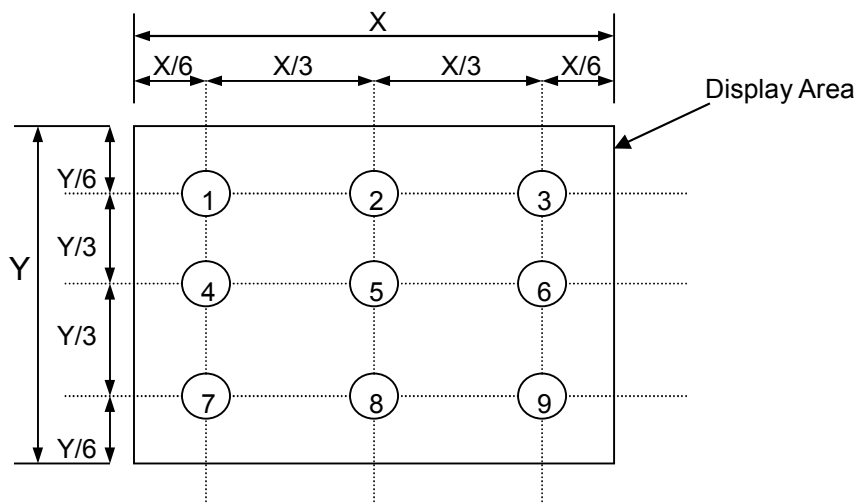

7. Block Diagram and Power Supply

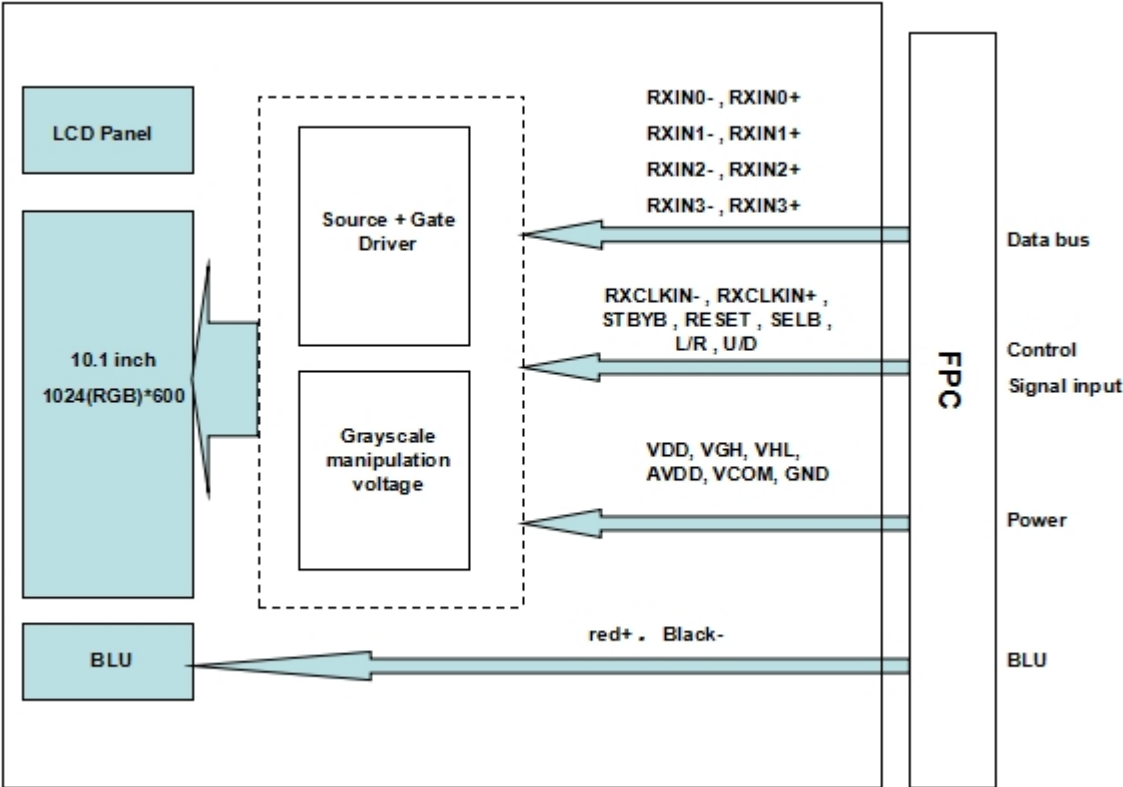

8. Interface Pins Definition

1	VCOM	Common Voltage
2	VDD	Power Voltage for digital circuit
3	VDD	Power Voltage for digital circuit
4	NC	No connection
5	RESET	Global reset pin
6	STBYB	Standby mode, Normally pulled high. STBYB="1", normal operation STBYB="0", timing controller, source driver will turn off
7	GND	Ground
8	RXIN0-	-LVDS differential data input
9	RXIN0+	+LVDS differential data input
10	GND	Ground
11	RXIN1-	-LVDS differential data input
12	RXIN1+	+LVDS differential data input
13	GND	Ground
14	RXIN2-	-LVDS differential data input
15	RXIN2+	+LVDS differential data input
16	GND	Ground
17	RXCLKIN-	-LVDS differential clock input
18	RXCLKIN+	+LVDS differential clock input
19	GND	Ground
20	RXIN3-	-LVDS differential data input
21	RXIN3+	+LVDS differential data input
22	GND	Ground
23	NC	No connection
24	NC	No connection
25	GND	Ground
26	NC	No connection
27	NC	No connection
28	SELB	"L": 8bit LVDS interface "H":6bit LVDS interface
29	AVDD	Power for Analog Circuit
30	GND	Ground
31	LED-	No connection
32	LED-	No connection
33	L/R	Horizontal inversion
34	U/D	Vertical inversion
35	VGL	Gate OFF Voltage
36	NC	No connection
37	NC	No connection
38	VGH	Gate ON Voltage
39	LED+	No connection
40	LED+	No connection

8.1 BACKLIGHT UNIT PIN:

Symbol	Function
red+	LED Anode
Black-	LED Cathode

9. AC Characteristics

9.1. LVDS Mode AC Electrical Characteristics

Parameter	Symbol	Spec.			Unit	Condition
		Min.	Typ.	Max.		
Clock frequency	R_{XFCLK}	20	-	71	MHz	-
Input data skew margin	T_{RSKM}	500	-	-	pS	$ V_{ID} =400mV$ $R_{XVCM}=1.2V$ $R_{XFCLK}=71MHz$
Clock high time	T_{LVCH}	-	$4/(7 * R_{XFCLK})$	-	ns	-
Clock low time	T_{LVCL}	-	$3/(7 * R_{XFCLK})$	-	ns	-
PLL wake-up time	T_{emPLL}	-	-	150	μs	-

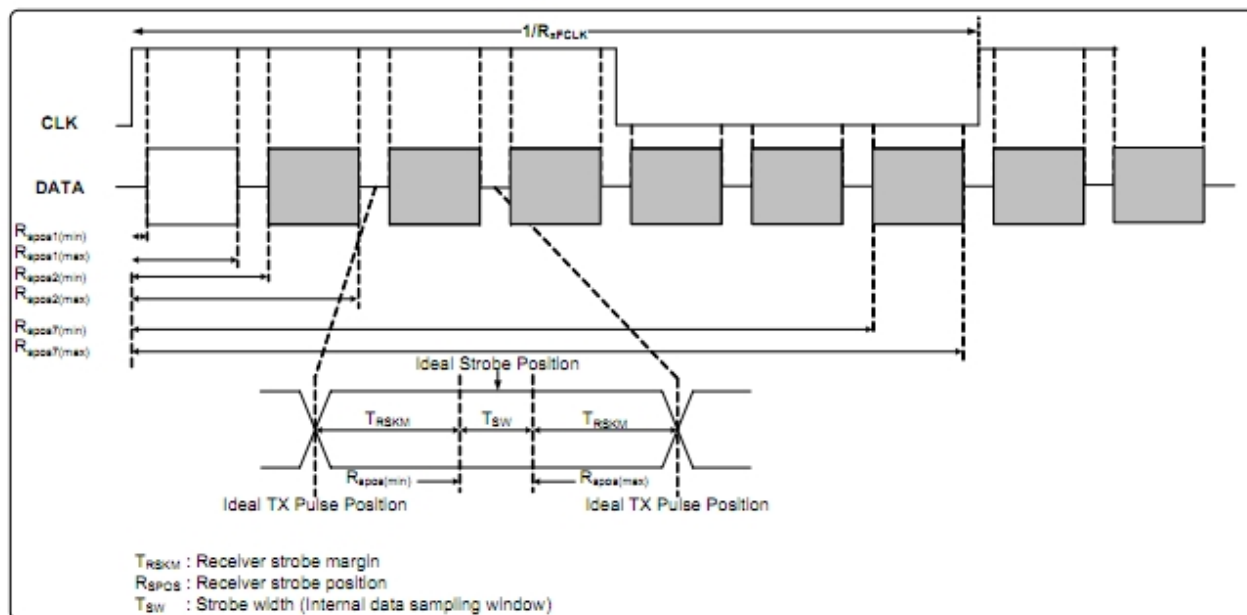
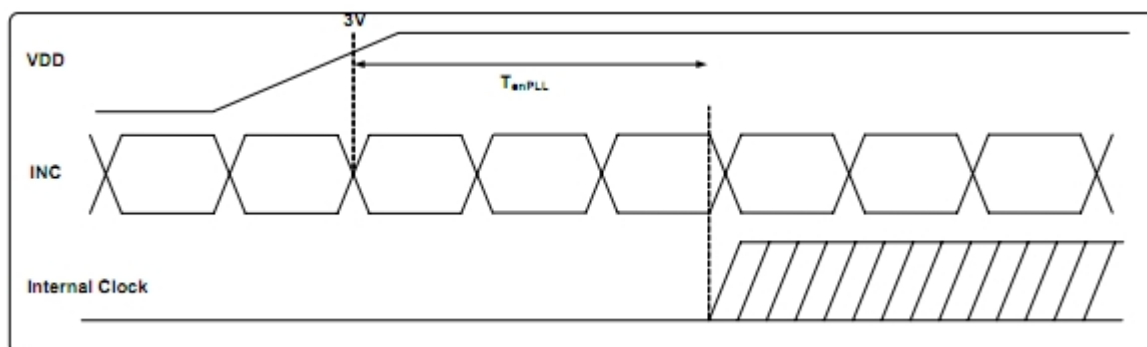
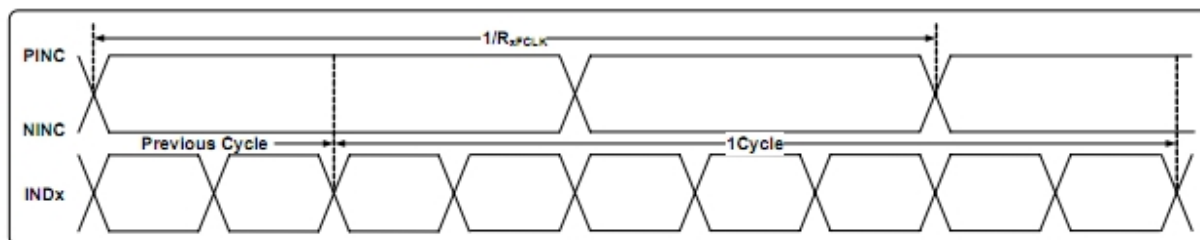

Parameter	Symbol	Spec.			Unit	Condition
		Min.	Typ.	Max.		
Modulation Frequency	SSC _{MF}	23	-	93	KHz	-
Modulation Rate	SSC _{MR}	-	-	±3	%	LVDS clock =71MHz center spread

9.2. Data Input Format

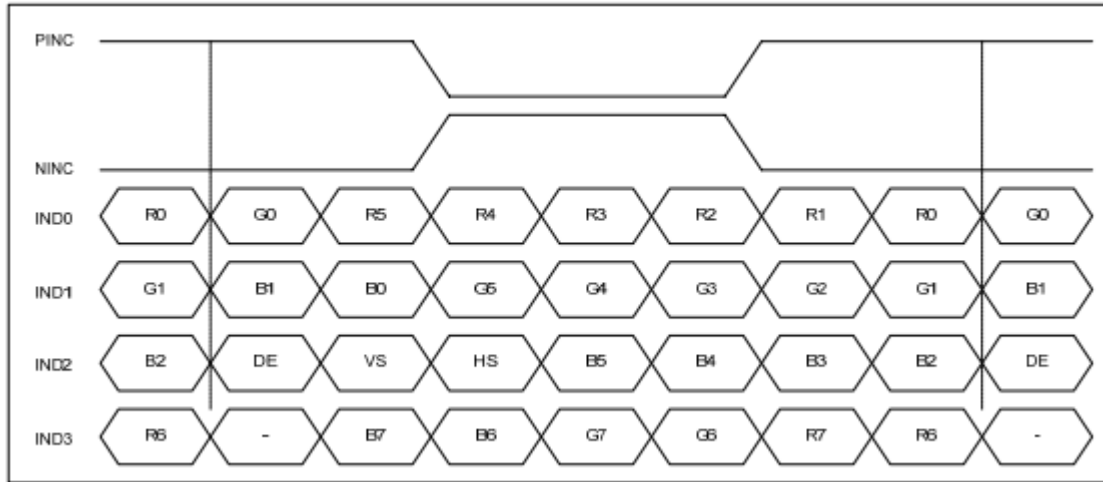

8-bit LVDS input

9.3. Parallel RGB Input Timing Table

DE Mode

Parameter	Symbol	Spec.			Unit
		Min.	Typ.	Max.	
DCLK Frequency	fclk	40.8	51.2	67.2	MHz
Horizontal Display Area	thd	1024			DCLK
HSD Period	th	1114	1344	1600	DCLK
HSD Blanking	thb+ thfp	90	320	376	DCLK
Vertical Display Area	tvd	600			T _H
VSD Period	tvbp	610	635	800	T _H
VSD Blanking	tvbp+ tvfp	10	35	200	T _H

HV Mode

Horizontal timing

Parameter	Symbol	Spec.			Unit
		Min.	Typ.	Max.	
DCLK Frequency	fclk	44.9	51.2	63	MHz
Horizontal Display Area	thd	1024			DCLK
HSD Period	th	1200	1344	1400	DCLK
HSD Pulse Width	thpw	1	-	140	DCLK
HSD Back Porch	thbp	160			DCLK
HSD Front Porch	thfp	16	160	216	DCLK

Vertical Timing

Parameter	Symbol	Spec.			Unit
		Min.	Typ.	Max.	
Vertical Display Area	tvd	600			T _H
VSD Period	tv	624	635	750	T _H
VSD Pulse Width	tvpw	1	-	20	T _H
VSD Back Porch	tvbp	23			T _H
VSD Front Porch	tvfp	1	12	127	T _H

10. Quality Assurance

10.1.Purpose

This standard for Quality Assurance assures the quality of LCD module products supplied to customer.

10.2.Standard for Quality Test

10.2.1. Sampling Plan:

GB2828.1-2012

Single sampling, general inspection level II

10.2.2. Sampling Criteria:

Visual inspection: AQL 1.5%

Electrical functional: AQL 0.65%.

10.2.3. Reliability Test:

Detailed requirement refer to Reliability Test Specification.

10.3.Nonconforming Analysis & Disposition

10.3.1. Nonconforming analysis:

10.3.1.1. Customer should provide overall information of non-conforming sample for their complaints.

10.3.1.2. After receipt of detailed information from customer, the analysis of nonconforming parts usually should be finished in one week.

10.3.1.3. If cannot finish the analysis on time, customer will be notified with the progress status.

10.3.2. Disposition of nonconforming:

10.3.2.1. Non-conforming product over PPM level will be replaced.

10.3.2.2. The cause of non-conformance will be analyzed. Corrective action will be discussed and implemented.

10.4.Agreement Items

Shall negotiate with customer if the following situation occurs:

10.4.1. There is any discrepancy in standard of quality assurance.

10.4.2. Additional requirement to be added in product specification.

10.4.3. Any other special problem.

10.5. Standard of the Product Visual Inspection

10.5.1. Appearance inspection:

10.5.1.1. The inspection must be under illumination about 1000 – 1500 lx, and the distance of view must be at 30cm ± 2cm.

10.5.1.2. The viewing angle should be 45° from the vertical line without reflection light or follows customer's viewing angle specifications.

10.5.1.3. Definition of area: A Zone: Active Area, B Zone: Viewing Area,

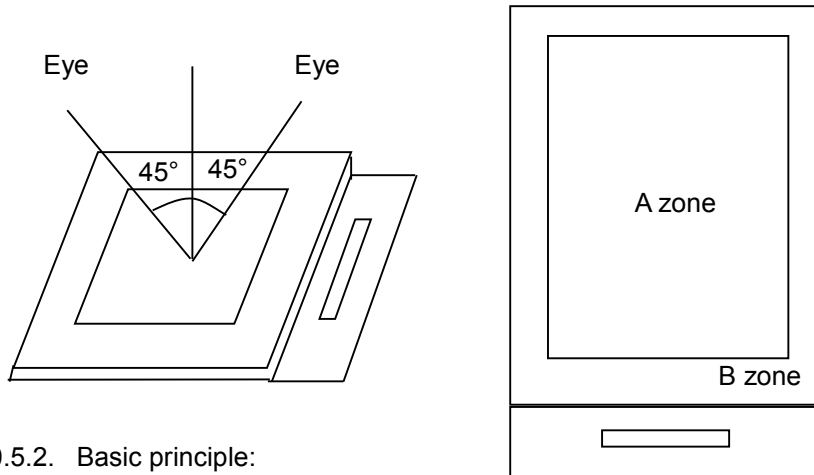

10.5.2. Basic principle:

10.5.2.1. A set of sample to indicate the limit of acceptable quality level must be discussed by both us and customer when there is any dispute happened.

10.5.2.2. New item must be added on time when it is necessary.

10.6. Inspection Specification

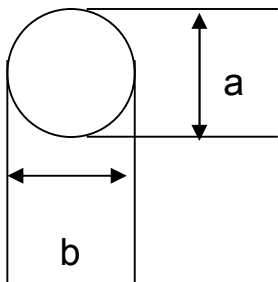
No.	Item	Criteria (Unit: mm)												
01	Black / White spot Foreign material (Round type) Pinholes Stain Particles inside cell. (Minor defect)	 <div style="margin-top: 10px;"> $\phi = (a + b) / 2$ </div> <p>Distance between 2 defects should more than 5mm apart.</p> <table border="1" style="margin-left: 20px;"> <thead> <tr> <th>Size</th> <th>Area</th> <th>Acc. Qty</th> </tr> </thead> <tbody> <tr> <td>$\phi \leq 0.20$</td> <td></td> <td>Ignore</td> </tr> <tr> <td>$0.20 < \phi \leq 0.50$</td> <td></td> <td>$N \leq 3$</td> </tr> <tr> <td>$0.50 < \phi$</td> <td></td> <td>0</td> </tr> </tbody> </table>	Size	Area	Acc. Qty	$\phi \leq 0.20$		Ignore	$0.20 < \phi \leq 0.50$		$N \leq 3$	$0.50 < \phi$		0
Size	Area	Acc. Qty												
$\phi \leq 0.20$		Ignore												
$0.20 < \phi \leq 0.50$		$N \leq 3$												
$0.50 < \phi$		0												

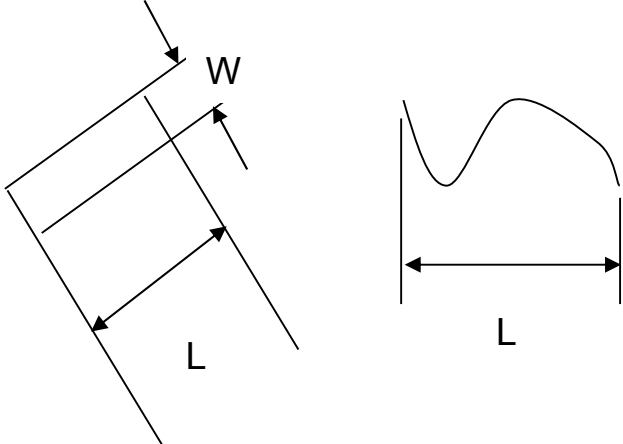
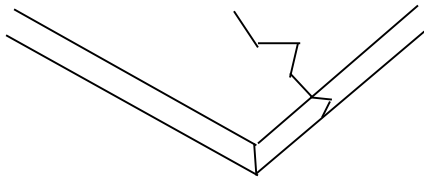
<p>02</p>	<p>Electrical Defect (Minor defect)</p>	<table border="1"> <tr> <td rowspan="2">Bright dot</td> <td>Display Area</td> <td>Total</td> <td rowspan="3">Note1</td> </tr> <tr> <td>$N \leq 2$</td> <td>$N \leq 2$</td> </tr> <tr> <td>Dark dot</td> <td>$N \leq 4$</td> <td>$N \leq 4$</td> </tr> <tr> <td>Total dot</td> <td>$N \leq 4$</td> <td>$N \leq 4$</td> <td></td> </tr> <tr> <td>Mura</td> <td colspan="2">Not visible through 5% ND filters.</td> <td>Note 2</td> </tr> </table> <p>Remark: 1. Bright dot caused by scratch and foreign object accords to item 1.</p>	Bright dot	Display Area	Total	Note1	$N \leq 2$	$N \leq 2$	Dark dot	$N \leq 4$	$N \leq 4$	Total dot	$N \leq 4$	$N \leq 4$		Mura	Not visible through 5% ND filters.		Note 2
Bright dot	Display Area	Total		Note1															
	$N \leq 2$	$N \leq 2$																	
Dark dot	$N \leq 4$	$N \leq 4$																	
Total dot	$N \leq 4$	$N \leq 4$																	
Mura	Not visible through 5% ND filters.		Note 2																
<p>03</p>	<p>Black and White line Scratch Foreign material (Line type) (Minor defect)</p>	 <table border="1"> <thead> <tr> <th>Length</th> <th>Width</th> <th>Acc. Qty</th> </tr> </thead> <tbody> <tr> <td>/</td> <td>$W \leq 0.1$</td> <td>Ignore</td> </tr> <tr> <td>$L \leq 2.5$</td> <td>$0.1 < W \leq 0.2$</td> <td>3</td> </tr> <tr> <td>$L > 2.5$</td> <td>$0.2 < W$</td> <td>0</td> </tr> <tr> <td colspan="2">Total</td> <td>3</td> </tr> </tbody> </table> <p>Distance between 2 defects should more than 3mm apart. Scratches not viewable through the back of the display are acceptable.</p>	Length	Width	Acc. Qty	/	$W \leq 0.1$	Ignore	$L \leq 2.5$	$0.1 < W \leq 0.2$	3	$L > 2.5$	$0.2 < W$	0	Total		3		
Length	Width	Acc. Qty																	
/	$W \leq 0.1$	Ignore																	
$L \leq 2.5$	$0.1 < W \leq 0.2$	3																	
$L > 2.5$	$0.2 < W$	0																	
Total		3																	
<p>04</p>	<p>Glass Crack (Minor defect)</p>	 <p>Crack is potential to enlarge, any type is not allowed.</p>																	

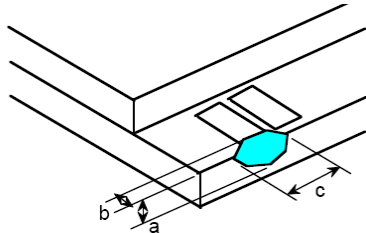
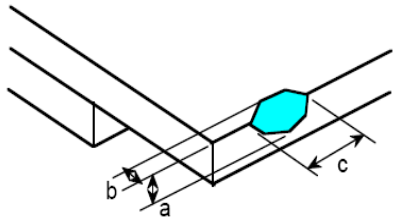
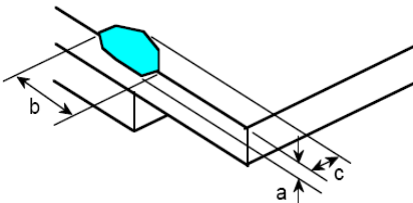
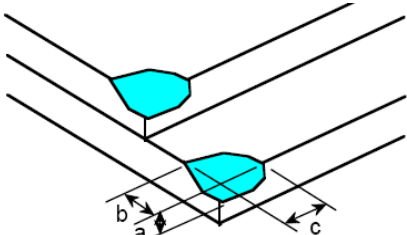
<p>05</p>	<p>Glass Chipping Pad Area: (Minor defect)</p> 	<table border="1"> <thead> <tr> <th>Length and Width</th> <th>Acc. Qty</th> </tr> </thead> <tbody> <tr> <td>$c > 3.0, b < 1.0$</td> <td>1</td> </tr> <tr> <td>$c < 3.0, b < 1.0$</td> <td>3</td> </tr> <tr> <td colspan="2" style="text-align: center;">$a < \text{Glass Thickness}$</td> </tr> </tbody> </table>	Length and Width	Acc. Qty	$c > 3.0, b < 1.0$	1	$c < 3.0, b < 1.0$	3	$a < \text{Glass Thickness}$			
Length and Width	Acc. Qty											
$c > 3.0, b < 1.0$	1											
$c < 3.0, b < 1.0$	3											
$a < \text{Glass Thickness}$												
<p>06</p>	<p>Glass Chipping Rear of Pad Area: (Minor defect)</p> 	<table border="1"> <thead> <tr> <th>Length and Width</th> <th>Acc. Qty</th> </tr> </thead> <tbody> <tr> <td>$c > 3.0, b < 1.0$</td> <td>1</td> </tr> <tr> <td>$c < 3.0, b < 1.0$</td> <td>2</td> </tr> <tr> <td>$c < 3.0, b < 0.5$</td> <td>4</td> </tr> <tr> <td colspan="2" style="text-align: center;">$a < \text{Glass Thickness}$</td> </tr> </tbody> </table>	Length and Width	Acc. Qty	$c > 3.0, b < 1.0$	1	$c < 3.0, b < 1.0$	2	$c < 3.0, b < 0.5$	4	$a < \text{Glass Thickness}$	
Length and Width	Acc. Qty											
$c > 3.0, b < 1.0$	1											
$c < 3.0, b < 1.0$	2											
$c < 3.0, b < 0.5$	4											
$a < \text{Glass Thickness}$												
<p>07</p>	<p>Glass Chipping Except Pad Area: (Minor defect)</p> 	<table border="1"> <thead> <tr> <th>Length and Width</th> <th>Acc. Qty</th> </tr> </thead> <tbody> <tr> <td>$c > 3.0, b < 1.0$</td> <td>1</td> </tr> <tr> <td>$c < 3.0, b < 1.0$</td> <td>2</td> </tr> <tr> <td>$c < 3.0, b < 0.5$</td> <td>4</td> </tr> <tr> <td colspan="2" style="text-align: center;">$a < \text{Glass Thickness}$</td> </tr> </tbody> </table>	Length and Width	Acc. Qty	$c > 3.0, b < 1.0$	1	$c < 3.0, b < 1.0$	2	$c < 3.0, b < 0.5$	4	$a < \text{Glass Thickness}$	
Length and Width	Acc. Qty											
$c > 3.0, b < 1.0$	1											
$c < 3.0, b < 1.0$	2											
$c < 3.0, b < 0.5$	4											
$a < \text{Glass Thickness}$												
<p>08</p>	<p>Glass Corner Chipping: (Minor defect)</p> 	<table border="1"> <thead> <tr> <th>Length and Width</th> <th>Acc. Qty</th> </tr> </thead> <tbody> <tr> <td>$c < 3.0, b < 3.0$</td> <td>Ignore</td> </tr> <tr> <td colspan="2" style="text-align: center;">$a < \text{Glass Thickness}$</td> </tr> </tbody> </table>	Length and Width	Acc. Qty	$c < 3.0, b < 3.0$	Ignore	$a < \text{Glass Thickness}$					
Length and Width	Acc. Qty											
$c < 3.0, b < 3.0$	Ignore											
$a < \text{Glass Thickness}$												

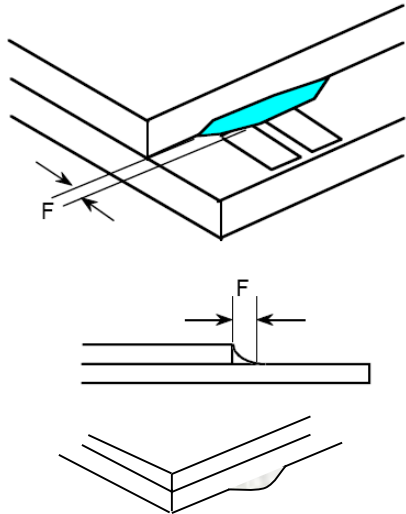
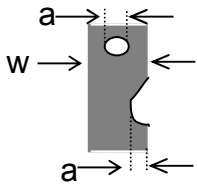
<p>09</p>	<p>Glass Burr: (Minor defect)</p> 	<table border="1" data-bbox="860 264 1332 351"> <thead> <tr> <th>Length</th> <th>Acc. Qty</th> </tr> </thead> <tbody> <tr> <td>$F < 1.0$</td> <td>Ignore</td> </tr> </tbody> </table> <p>Glass burr don't affect assemble and module dimension.</p>	Length	Acc. Qty	$F < 1.0$	Ignore				
Length	Acc. Qty									
$F < 1.0$	Ignore									
<p>10</p>	<p>FPC Defect: (Minor defect)</p> 	<p>10.1 Dent, pinhole width $a < w/3$. (w: circuitry width.)</p> <p>10.2 Open circuit is unacceptable.</p> <p>10.3 No oxidation, contamination and distortion.</p>								
<p>11</p>	<p>Bubble on Polarizer (Minor defect)</p>	<table border="1" data-bbox="735 1339 1206 1512"> <thead> <tr> <th>Diameter</th> <th>Acc. Qty</th> </tr> </thead> <tbody> <tr> <td>$\varphi \leq 0.30$</td> <td>Ignore</td> </tr> <tr> <td>$0.30 < \varphi \leq 0.50$</td> <td>$N \leq 2$</td> </tr> <tr> <td>$0.50 < \varphi$</td> <td>$N = 0$</td> </tr> </tbody> </table>	Diameter	Acc. Qty	$\varphi \leq 0.30$	Ignore	$0.30 < \varphi \leq 0.50$	$N \leq 2$	$0.50 < \varphi$	$N = 0$
Diameter	Acc. Qty									
$\varphi \leq 0.30$	Ignore									
$0.30 < \varphi \leq 0.50$	$N \leq 2$									
$0.50 < \varphi$	$N = 0$									
<p>12</p>	<p>Dent on Polarizer (Minor defect)</p>	<table border="1" data-bbox="735 1585 1206 1758"> <thead> <tr> <th>Diameter</th> <th>Acc. Qty</th> </tr> </thead> <tbody> <tr> <td>$\varphi \leq 0.25$</td> <td>Ignore</td> </tr> <tr> <td>$0.25 < \varphi \leq 0.50$</td> <td>$N \leq 4$</td> </tr> <tr> <td>$0.50 < \varphi$</td> <td>None</td> </tr> </tbody> </table>	Diameter	Acc. Qty	$\varphi \leq 0.25$	Ignore	$0.25 < \varphi \leq 0.50$	$N \leq 4$	$0.50 < \varphi$	None
Diameter	Acc. Qty									
$\varphi \leq 0.25$	Ignore									
$0.25 < \varphi \leq 0.50$	$N \leq 4$									
$0.50 < \varphi$	None									
<p>13</p>	<p>Bezel</p>	<p>13.1 No rust, distortion on the Bezel.</p> <p>13.2 No visible fingerprints, stains or other contamination.</p>								

14	Touch Panel	<p>D: Diameter W: width L: length</p> <p>14.1 Spot: $D < 0.25$ is acceptable $0.25 \leq D \leq 0.4$</p> <p>2dots are acceptable and the distance between defects should more than 10 mm.</p> <p>$D > 0.4$ is unacceptable</p> <p>14.2 Dent: $D > 0.40$ is unacceptable</p> <p>14.3 Scratch: $W \leq 0.03$, $L \leq 10$ is acceptable, $0.03 < W \leq 0.10$, $L \leq 10$ is acceptable</p> <p>Distance between 2 defects should more than 10 mm. $W > 0.10$ is unacceptable.</p>
15	PCB	<p>15.1 No distortion or contamination on PCB terminals.</p> <p>15.2 All components on PCB must same as documented on the BOM/component layout.</p> <p>15.3 Follow IPC-A-600F.</p>
16	Soldering	Follow IPC-A-610C standard
17	Electrical Defect (Major defect)	<p>The below defects must be rejected.</p> <p>17.1 Missing vertical / horizontal segment,</p> <p>17.2 Abnormal Display.</p> <p>17.3 No function or no display.</p> <p>17.4 Current exceeds product specifications.</p> <p>17.5 LCD viewing angle defect.</p> <p>17.6 No Backlight.</p> <p>17.7 Dark Backlight.</p> <p>17.8 Touch Panel no function.</p>

Remark: LCD Panel Broken shall be rejected. Defect out of LCD viewing area is acceptable.

10.7. Classification of Defects

10.7.1. Visual defects (Except no / wrong label) are treated as minor defect and electrical defect is major.

10.7.2. Two minor defects are equal to one major in lot sampling inspection.

10.8. Identification/marketing criteria

Any unit with illegible / wrong /double or no marking/ label shall be rejected.

10.9.Packing

- 10.9.1. There should be no damage of the outside carton box, each packaging box should have one identical label.
- 10.9.2. Modules inside package box should have compliant mark.
- 10.9.3. All direct package materials shall offer ESD protection.

Note1: Bright dot is defined as the defective area of the dot is larger than 50% of one sub-pixel area.

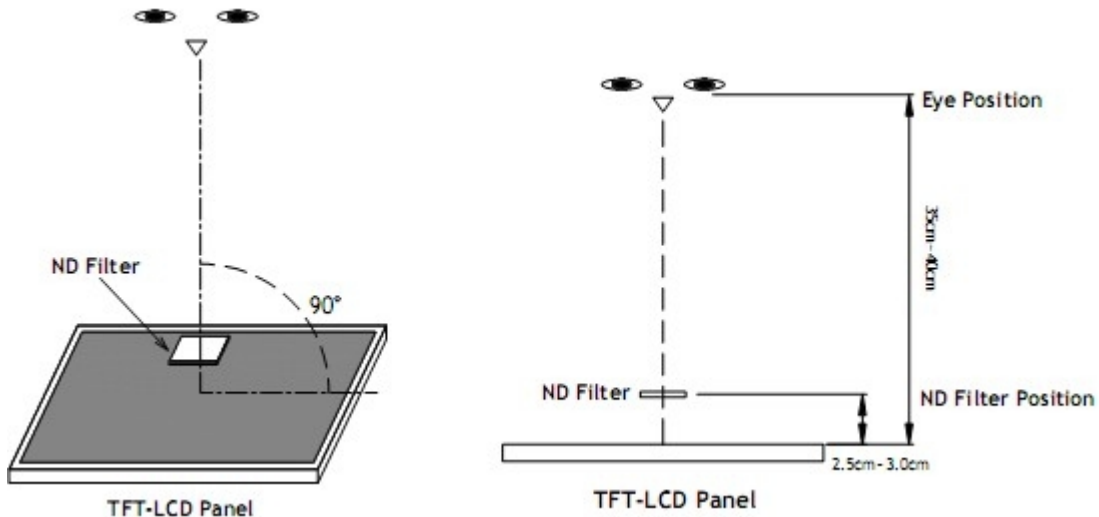

Bright dot: The bright dot size defect at black display pattern. It can be recognized by 2% transparency of filter when the distance between eyes and panel is 350mm ± 50mm.

Dark dot: Cyan, Magenta or Yellow dot size defect at white display pattern. It can be recognized by 5% transparency of filter when the distance between eyes and panel is 350mm ± 50mm.

Note2: Mura on display which appears darker / brighter against background brightness on parts of display area.

11. Reliability Specification

No	Item	Condition	Quantity	Criteria
1	High Temperature Operating	+70°C, 96Hrs	2	GB/T2423.2-2008
2	Low Temperature Operating	-20°C, 96Hrs	2	GB/T2423.1-2008
3	High Humidity	+50°C, 90%RH, 96Hrs	2	GB/T2423.3-2006
4	High Temperature Storage	+80°C, 96Hrs	2	GB/T2423.2-2008
5	Low Temperature Storage	-30°C, 96Hrs	2	GB/T2423.1-2008
6	Thermal Cycling Test	-20°C, 60min~+70°C, 60min, 20 cycles.	2	GB/T2423.22-2012
7	Packing vibration	Frequency Range:10Hz~50Hz Acceleration of Gravity:5G X,Y,Z 30 min for each Direction.	2	GB/T5170.14-2009
8	Electrical Static Discharge	Air: ±8kV 150pF/330 Ω 5 times Contact: ±4kV 150pF/330 Ω 5 times	2	GB/T17626.2-2006
9	Drop Test (Packaged)	Height:80 cm,1 corner, 3 edges, 6 Surfaces.	2	GB/T2423.8-1995

Note1. No defection cosmetic and operational function allowable.

Note2. Total current Consumption should be below double of initial value

12. Precautions and Warranty

12.1. Safety

- 12.1.1. The liquid crystal in the LCD is poisonous. Do not put it in your mouth. If the liquid crystal touches your skin or clothes, wash it off immediately using soap and water.
- 12.1.2. Since the liquid crystal cells are made of glass, do not apply strong impact on them. Handle with care.

12.2. Handling

- 12.2.1. Reverse and use within ratings in order to keep performance and prevent damage.
- 12.2.2. Do not wipe the polarizer with dry cloth, as it might cause scratch. If the surface of the LCD needs to be cleaned, wipe it swiftly with cotton or other soft cloth soaked with petroleum IPA, do not use other chemicals.

12.3. Storage

- 12.3.1. Do not store the LCD module beyond the specified temperature ranges.
- 12.3.2. Strong light exposure causes degradation of polarizer and color filter.

12.4. Metal Pin (Apply to Products with Metal Pins)

12.4.1. Pins of LCD and Backlight

12.4.1.1. Solder tip can touch and press on the tip of Pin LEAD during the soldering

12.4.1.2. Recommended Soldering Conditions

Solder Type: Sn96.3~94-Ag3.3~4.3-Cu0.4~1.1

Maximum Solder Temperature: 370°C

Maximum Solder Time: 3s at the maximum temperature

Recommended Soldering Temp: 350±20°C

Typical Soldering Time: ≤3s

12.4.1.3. Solder Wetting

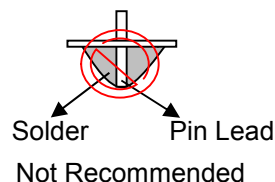
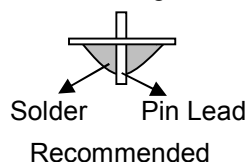

12.4.2. Pins of EL

12.4.2.1. Solder tip can touch and press on the tip of EL leads during soldering.

12.4.2.2. No Solder Paste on the soldering pad on the motherboard is recommended.

12.4.2.3. Recommended Soldering Conditions

Solder type: Nippon Alimit Leadfree SR-34, size 0.5mm

Recommended Solder Temperature: 270~290°C

Typical Soldering Time: ≤2s

Minimum solder distance from EL lamp (body):2.0mm

12.4.2.4. No horizontal press on the EL leads during soldering.

12.4.2.5. 180° bend EL leads three times is not allowed.

12.4.2.6. Solder Wetting

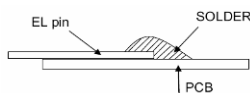

Recommended



Not Recommended

12.4.2.7. The type of the solder iron:

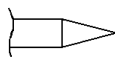

Recommended

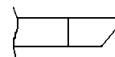

Not Recommended

12.4.2.8. Solder Pad

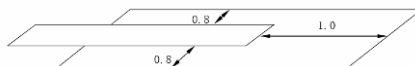

12.5.Operation

- 12.5.1. Do not drive LCD with DC voltage
- 12.5.2. Response time will increase below lower temperature
- 12.5.3. Display may change color with different temperature
- 12.5.4. Mechanical disturbance during operation, such as pressing on the display area, may cause the segments to appear “fractured”.
- 12.5.5. Do not connect or disconnect the LCM to or from the system when power is on.
- 12.5.6. Never use the LCM under abnormal condition of high temperature and high humidity.
- 12.5.7. Module has high frequency circuits. Sufficient suppression to the electromagnetic interface shall be done by system manufacturers. Grounding and shielding methods may be important to minimize the interference.
- 12.5.8. Do not display the fixed pattern for long time(we suggest the time not longer than one hour) because it may develop image sticking due to the TFT structure.

12.6.Static Electricity

- 12.6.1. CMOS LSIs are equipped in this unit, so care must be taken to avoid the electro-static charge, by ground human body, etc.
- 12.6.2. The normal static prevention measures should be observed for work clothes and benches.
- 12.6.3. The module should be kept into anti-static bags or other containers resistant to static for storage.

12.7.Limited Warranty

- 12.7.1. Our warranty liability is limited to repair and/or replacement. We will not be responsible for any consequential loss.
- 12.7.2. If possible, we suggest customer to use up all modules in six months. If the module storage time over twelve months, we suggest that recheck it before the module be used.
- 12.7.3. After the product shipped, any product quality issues must be feedback within three months, otherwise, we will not be responsible for the subsequent or consequential events.

13. Outline Drawing

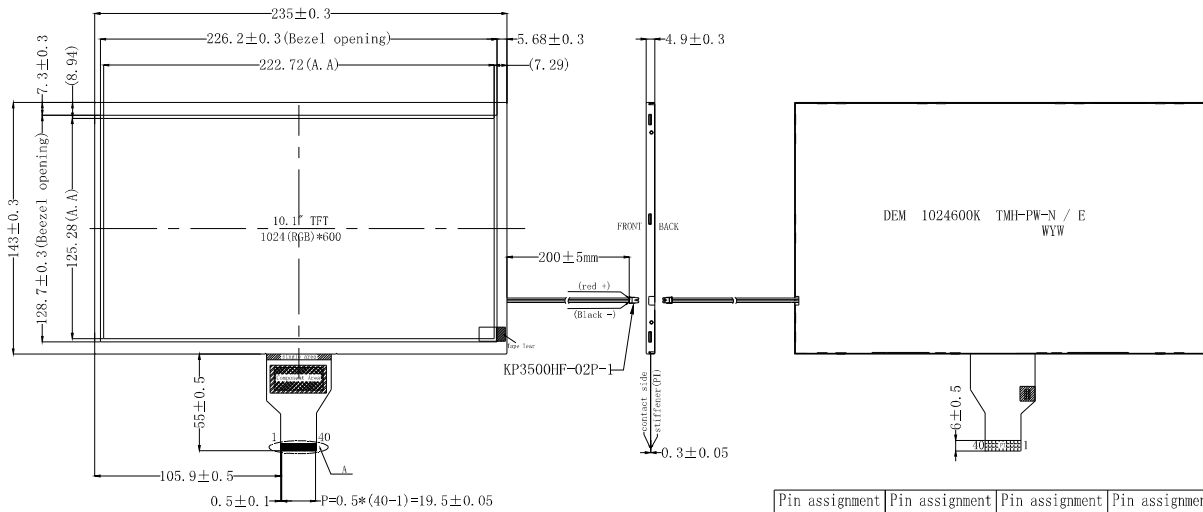

NOTES:

1. Display Size: 10.1" TFT
 2. Viewing Direction: 12 O' CLOCK
 3. Gary Scale Inversion Direction: 6 O' CLOCK
 4. Display Mode: Transmissive / Normal White
 5. Operation Temperature: -20° C to +70° C
 6. Storage Temperature: -30° C to +80° C
 7. Backlight: White (27xLEDs, 9.4V/180mA (typ.))
Luminance: 300cd/m2
 8. LED Lifetime: 30,000h(typ.)
 9. ROHS must be complied
- * Unspecification Tolerance are: +/-0.3mm

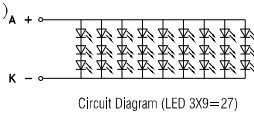
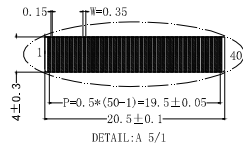

Pin assignment		Pin assignment		Pin assignment		Pin assignment	
PIN	SYMBOL	PIN	SYMBOL	PIN	SYMBOL	PIN	SYMBOL
1	VCOM	11	RXIN1-	21	RXIN3+	31	LED-
2	VDD	12	RXIN1+	22	GND	32	LED-
3	VDD	13	GND	23	NC	33	L/R
4	NC	14	RXIN2-	24	NC	34	U/D
5	RESET	15	RXIN2+	25	GND	35	VGL
6	STBYB	16	GND	26	NC	36	NC
7	GND	17	RXCLKN1-	27	NC	37	NC
8	RXIN0-	18	RXCLKN1+	28	SELB	38	VGH
9	RXIN0+	19	GND	29	AVDD	39	LED+
10	GND	20	RXIN3-	30	GND	40	LED+