

# Combo D® – Coaxial/50 Ohm

## Straight Receptacle for PCB Mounting (Board Thickness Up To .125 [3.18])

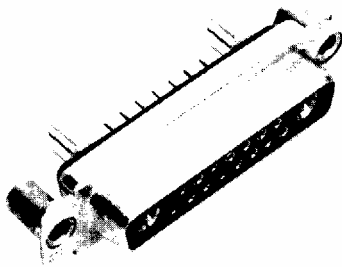

PCB Hole Patterns – Pages 35-36

Part numbers come complete with fixed, female, signal and coaxial contacts.

Tin PC tails, add – A220.

Contact Finish Integral Boardlock	Gold Over Ni No	Gold Over Ni Yes	30μ in. Gold No	30μ in. Gold Yes
DE-5W1	DEM5X1SNA197	DEM25X1SNA197	DEM5X1SNK126	DEM25X1SNK126
DA-7W2	DAMV7X2SNA197	DAM27X2SNA197	DAMV7X2SNK126	DAM27X2SNK126
DA-11W1	DAMV11X1SNA197	DAM211X1SNA197	DAMV11X1SNK126	DAM211X1SNK126
DA-3W3	DAMV3X3SNA197	DAM23X3SNA197	DAMV3X3SNK126	DAM23X3SNK126
DB-5W5	DBMV5X5SNA197	DBM25X5SNA197	DBMV5X5SNK126	DBM25X5SNK126
DB-9W4	DBMV9X4SNA197	DBM29X4SNA197	DBMV9X4SNK126	DBM29X4SNK126
DB-13W3	DBMV13X3SNA197	DBM213X3SNA197	DBMV13X3SNK126	DBM213X3SNK126
DB-17W2	DBMV17X2SNA197	DBM217X2SNA197	DBMV17X2SNK126	DBM217X2SNK126
DB-21W1	DBMV21X1SNA197	DBM221X1SNA197	DBMV21X1SNK126	DBM221X1SNK126
DC-8W8	DCMV8X8SNA197	DCM28X8SNA197	DCMV8X8SNK126	DCM28X8SNK126
DC-13W6	DCMV13X6SNA197	DCM213X6SNA197	DCMV13X6SNK126	DCM213X6SNK126
DC-17W5	DCMV17X5SNA197	DCM217X5SNA197	DCMV17X5SNK126	DCM217X5SNK126
DC-21WA4	DCMV21XA4SNA197	DCM221XA4SNA197	DCMV21XA4SNK126	DCM221XA4SNK126
DC-25W3	DCMV25X3SNA197	DCM225X3SNA197	DCMV25X3SNK126	DCM225X3SNK126
DC-27W2	DCMV27X2SNA197	DCM227X2SNA197	DCMV27X2SNK126	DCM227X2SNK126
DD-24W7	DDMV24X7SNA197	DDM24X7SNA197	DDMV24X7SNK126	DDM24X7SNK126
DD-36W4	DDMV36X4SNA197	DDM236X4SNA197	DDMV36X4SNK126	DDM236X4SNK126
DD-43W2	DDMV43X2SNA197	DDM243X2SNA197	DDMV43X2SNK126	DDM243X2SNK126
DD-47W1	DDMV47X1SNA197	DDM247X1SNA197	DDMV47X1SNK126	DDM247X1SNK126

## Straight Plug for PCB Mounting (Board Thickness up to .125 [3.18])

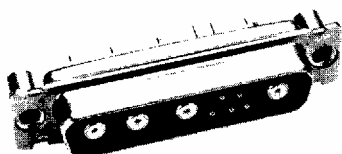

PCB Hole Patterns – Pages 35-36

Part numbers come complete with fixed, male, signal and coaxial contacts and standoffs.

Tin PC tails, add – A220.

Contact Finish Integral Boardlock	Gold Over Ni No	Gold Over Ni Yes	30μ in. Gold No	30μ in. Gold Yes
DE-5W1	DEM5X1PNK87	DEM25X1PNK87	DEM5X1PNK127	DEM25X1PNK127
DA-7W2	DAMV7X2PNK87	DAM27X2PNK87	DAMV7X2PNK127	DAM27X2PNK127
DA-11W1	DAMV11X1PNK87	DAM211X1PNK87	DAMV11X1PNK127	DAM211X1PNK127
DA-3W3	DAMV3X3PNK87	DAM23X3PNK87	DAMV3X3PNK127	DAM23X3PNK127
DB-5W5	DBMV5X5PNK87	DBM25X5PNK87	DBMV5X5PNK127	DBM25X5PNK127
DB-9W4	DBMV9X4PNK87	DBM29X4PNK87	DBMV9X4PNK127	DBM29X4PNK127
DB-13W3	DBMV13X3PNK87	DBM213X3PNK87	DBMV13X3PNK127	DBM213X3PNK127
DB-17W2	DBMV17X2PNK87	DBM217X2PNK87	DBMV17X2PNK127	DBM217X2PNK127
DB-21W1	DBMV21X1PNK87	DBM221X1PNK87	DBMV21X1PNK127	DBM221X1PNK127
DC-8W8	DCMV8X8PNK87	DCM28X8PNK87	DCMV8X8PNK127	DCM28X8PNK127
DC-13W6	DCMV13X6PNK87	DCM213X6PNK87	DCMV13X6PNK127	DCM213X6PNK127
DC-17W5	DCMV17X5PNK87	DCM217X5PNK87	DCMV17X5PNK127	DCM217X5PNK127
DC-21WA4	DCMV21XA4PNK87	DCM221XA4PNK87	DCMV21XA4PNK127	DCM221XA4PNK127
DC-25W3	DCMV25X3PNK87	DCM225X3PNK87	DCMV25X3PNK127	DCM225X3PNK127
DC-27W2	DCMV27X2PNK87	DCM227X2PNK87	DCMV27X2PNK127	DCM227X2PNK127
DD-24W7	DDMV24X7PNK87	DDM24X7PNK87	DDMV24X7PNK127	DDM24X7PNK127
DD-36W4	DDMV36X4PNK87	DDM236X4PNK87	DDMV36X4PNK127	DDM236X4PNK127
DD-43W2	DDMV43X2PNK87	DDM243X2PNK87	DDMV43X2PNK127	DDM243X2PNK127
DD-47W1	DDMV47X1PNK87	DDM247X1PNK87	DDMV47X1PNK127	DDM247X1PNK127

Highlighted part numbers indicate standard product; usually available with shorter lead times.

### Dimensions

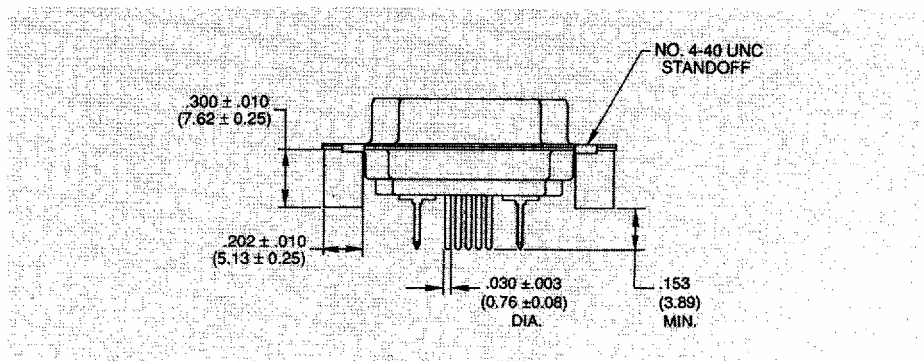

**ITT Cannon**

Dimensions are shown in inches (millimeters).  
Dimensions subject to change.

For technical assistance, price or delivery information, call your local technical sales office or distributor.

# Straight Printed Circuit Board Hole Pattern

Face view, pin insert  
(for receptacle, hole pattern is a mirror image)

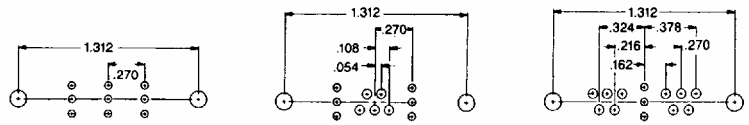
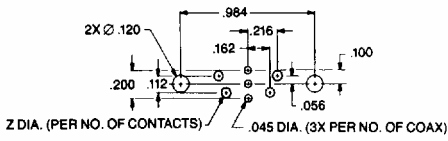

Shell Size **E**  
Contact Arrangement **5W1**  
No. of Signal Contacts **4 #20**  
No. of PC Coaxial Contacts **1**

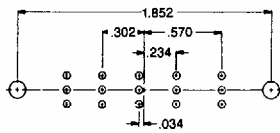

Shell Size **A**  
Contact Arrangement **3W3**  
No. of Signal Contacts **—**  
No. of PC Coaxial Contacts **3**

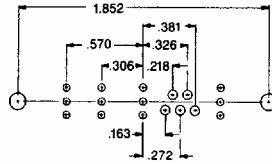

Shell Size **A**  
Contact Arrangement **7W2**  
No. of Signal Contacts **5 #20**  
No. of PC Coaxial Contacts **2**

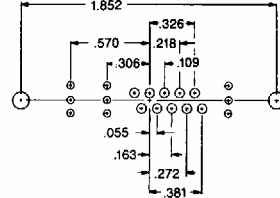

Shell Size **A**  
Contact Arrangement **11W1**  
No. of Signal Contacts **10 #20**  
No. of PC Coaxial Contacts **1**

Shell Size **B**  
Contact Arrangement **5W5**  
No. of Signal Contacts **—**  
No. of PC Coaxial Contacts **5**

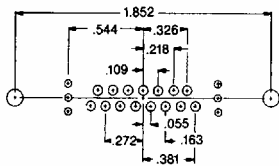

Shell Size **B**  
Contact Arrangement **9W4**  
No. of Signal Contacts **5 #20**  
No. of PC Coaxial Contacts **4**

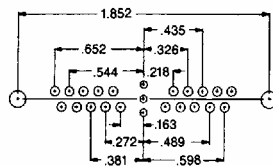

Shell Size **B**  
Contact Arrangement **13W3**  
No. of Signal Contacts **10 #20**  
No. of PC Coaxial Contacts **3**

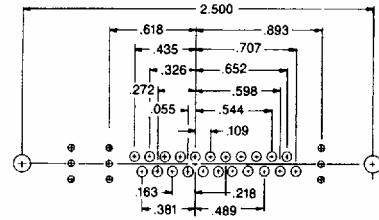

Shell Size **B**  
Contact Arrangement **17W2**  
No. of Signal Contacts **15 #20**  
No. of PC Coaxial Contacts **2**

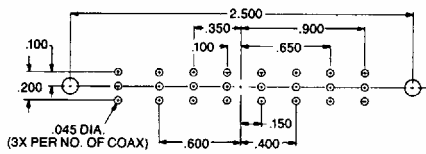

Shell Size **B**  
Contact Arrangement **21W1**  
No. of Signal Contacts **20 #20**  
No. of PC Coaxial Contacts **1**

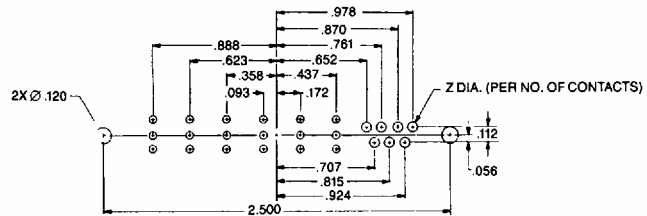

Shell Size **C**  
Contact Arrangement **25W3**  
No. of Signal Contacts **22 #20**  
No. of PC Coaxial Contacts **3**

Shell Size **C**  
Contact Arrangement **8W8**  
No. of Signal Contacts **—**  
No. of PC Coaxial Contacts **8**

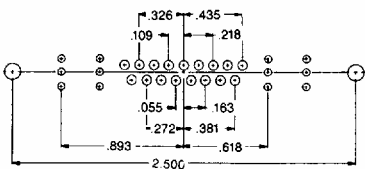

Shell Size **C**  
Contact Arrangement **13W6**  
No. of Signal Contacts **7 #20**  
No. of PC Coaxial Contacts **6**

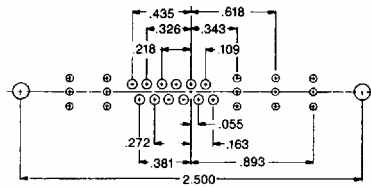

Shell Size **C**  
Contact Arrangement **21WA4**  
No. of Signal Contacts **17 #20**  
No. of PC Coaxial Contacts **4**

Shell Size **C**  
Contact Arrangement **17W5**  
No. of Signal Contacts **12 #20**  
No. of PC Coaxial Contacts **5**

Size No. 20	Contact PC	Z
Tail Dia.	Tail Dia.	Dia.
.030 (0.76)		.045 (1.14)

**ITT Cannon**

For technical assistance, price or delivery information, call your local technical sales office or distributor.

Dimensions are shown in inches (millimeters).  
Dimensions subject to change.

# Combo D<sup>®</sup> - Coaxial

## Straight Printed Circuit Board Hole Patterns

Face view, pin insert  
(for receptacle, hole pattern is a mirror image)

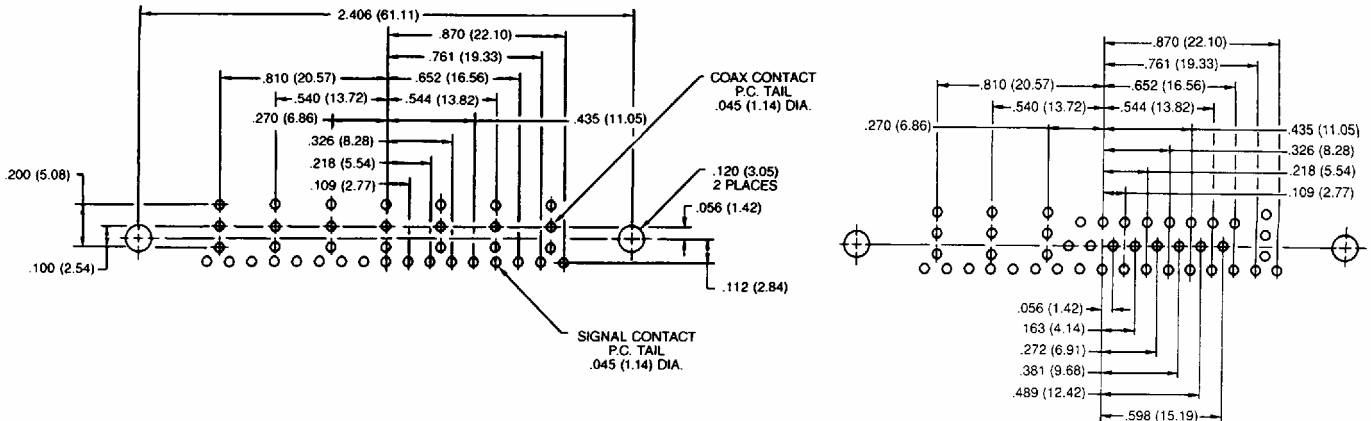

Shell Size  
Contact Arrangement  
No. of Signal Contacts  
No. of Coaxial Contacts

**D**  
**24W7**  
**17 #20**  
**7**

**D**  
**36W4**  
**32 #20**  
**4**

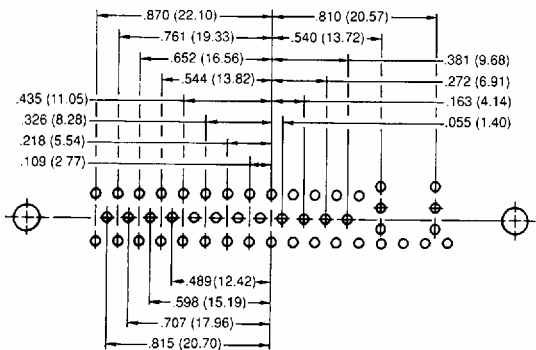

Shell Size  
Contact Arrangement  
No. of Signal Contacts  
No. of Coaxial Contacts

**D**  
**43W2**  
**41 #20**  
**2**

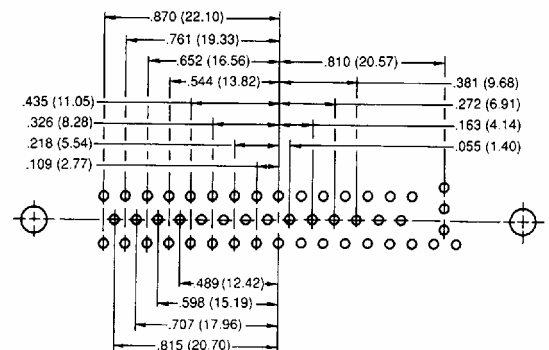

**D**  
**47W1**  
**46 #20**  
**1**



For technical assistance, price or delivery information, call your local technical sales office or distributor.

Dimensions are shown in inches (millimeters).  
Dimensions subject to change.

Combination D Subminiature connectors are the fastest growing segment of the D Subminiature market. ITT Cannon engineering teams, in keeping pace with the demands of the industry, have developed the broadest selection of Combination D Subminiatures available.

We offer the ability to integrate signal and 50 and 75 ohm coax, high power, and high voltage. You can mix red, green, and blue video lines with signal and up to 40 amps of power in the same package.

Design variations of the new Combo D connector, versus other packaging methods, include the proven ITT Cannon polarized "D" shape to prevent mismatching; dense, space-saving packaging; and diverse mounting options. Choose from a variety of cable and printed wiring board selections. Printed wiring board combos come pre-assembled with fixed contacts eliminating the need to buy several components.

This new line of connectors offers you **unlimited design versatility**.

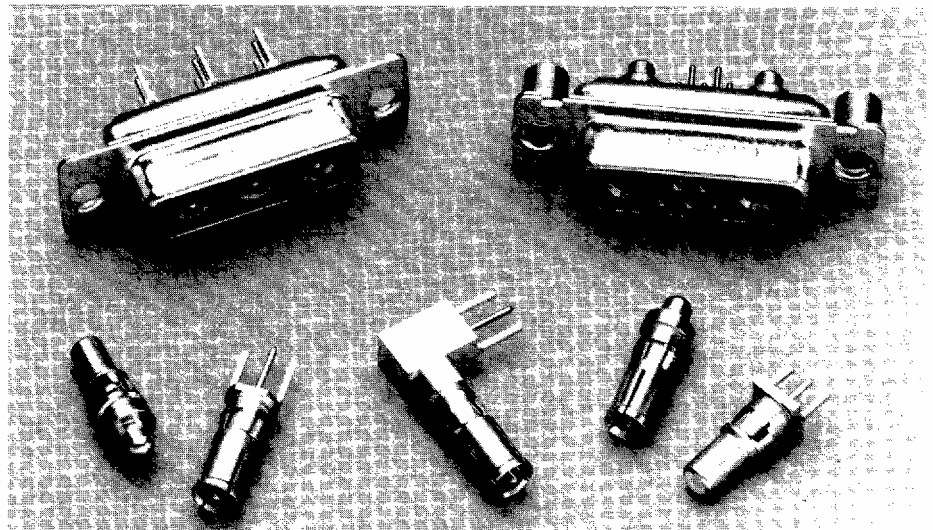

Straight and right angle printed wiring board contacts are available in both coax and high power versions.

## Performance and Material Specifications

### Connector Assemblies

Description	Material	Finish
Shell	Steel	Tin
Insulator	Thermoplastic or Diallyl Phthalate, UL 94V-0 rated.	None
Size 20 contacts when applicable	Copper alloy	Gold over nickel or 30μ inches, gold over nickel.
Standoff	Copper alloy	Electrodeposited Tin/Lead over Copper
Bracket	Steel	
Rivnut	Steel or Copper alloy	Electrodeposited Tin/Lead over Copper.
Eyelet	Copper alloy	

### Coaxial Assembly

Contacts and shells	Copper alloy	Gold over nickel or 50μ inches gold over copper.
Ring, retaining	Copper alloy	Nickel
Insulator	Teflon	None

U.L. File Number: E8572

### Performance Data

Signal Contact Current Rating	5 Amp
Temperature Rating	-65°C to +150°C
Signal Contact Resistance millivolt max.	55 @ 7.5 Amp test current
Coax Impedance	75 or 50 ohm
Coax VSWR	Less than 1.3-1.0 up to 500 megahertz
Coax Insertion Loss	.1 db loss at 500 megahertz.

### Dielectric Withstanding Voltage

Type of Contact		Altitude (feet/m)							
		Sea Level		20,000/6096		50,000/15240		70,000/1336	
		90°	Straight	90°	Straight	90°	Straight	90°	Straight
Center Conductor to Coaxial Shell	Average Flashover	1200	1500	900	1000	600	700	400	500
	Test	800	1000	600	650	400	475	275	325
Coaxial Shell to Nearest Standard Solder Pot Contact	Average Flashover	•	1500	•	1500	•	900	•	650
	Test	•	1000	•	1000	•	600	•	425
High Power contact and/or Coaxial Shell to Plug Shell	Average Flashover	1500	1500	1000	1000	500	500	500	500
	Test	1000	1000	650	650	325	325	325	325
#20 Signal	Average Flashover	1700		1000		650		500	
	Test	1250		750		475		375	
HV Contact to Nearest Contact or to Shell	Average Flashover	3800	3800	2300	2300	900	900	650	650
	Test	2800	2800	1700	1700	675	675	475	475

All voltage figures are rms AC 60 rms cps, measured at approximately +25°C, 50% rh.

Impedance: 50 ohm, 75 ohm

# ITT Cannon

For technical assistance, price or delivery information, call your local technical sales office or distributor.

# Combo D® – Coaxial 75 and 50 Ohm

## Coaxial Housing With Solder Cup Signal Contacts

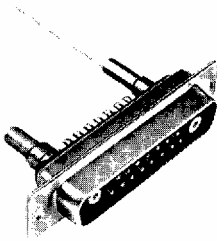

- Cable combinations supplied with preloaded solder signal contacts
- 50 ohm coax contacts supplied separately (see pages 27-28)
- 75 ohm coax contacts supplied separately (see page 23)

Clinch Nut and Float Mount Options Available:

Add: E = 4-40 Clinch Nut

Y = Float Mounting

Example: DAME3W3PK87

DAMY3W3PK87

Mounting Method Detail – Page 6.

Layout	Standard Socket	30 $\mu$ in. Gold Socket	Standard Pin	30 $\mu$ in. Gold Pin
DE-5W1	DEM5W1SA197	DEM5W1SK126	DEM5W1PK87	DEM5W1PK127
DA-7W2	DAM7W2SA197	DAM7W2SK126	DAM7W2PK87	DAM7W2PK127
DA-11W1	DAM11W1SA197	DAM11W1SK126	DAM11W1PK87	DAM11W1PK127
DA-3W3	DAM3W3SA197	DAM3W3SK126	DAM3W3PK87	DAM3W3PK127
DB-5W5	DBM5W5SA197	DBM5W5SK126	DBM5W5PK87	DBM5W5PK127
DB-9W4	DBM9W4SA197	DBM9W4SK126	DBM9W4PK87	DBM9W4PK127
DB-13W3	DBM13W3SA197	DBM13W3SK126	DBM13W3PK87	DBM13W3PK127
DB-17W2	DBM17W2SA197	DBM17W2SK126	DBM17W2PK87	DBM17W2PK127
DB-21W1	DBM21W1SA197	DBM21W1SK126	DBM21W1PK87	DBM21W1PK127
DC-8W8	DCM8W8SA197	DCM8W8SK126	DCM8W8PK87	DCM8W8PK127
DC-13W6	DCM13W6SA197	DCM13W6SK126	DCM13W6PK87	DCM13W6PK127
DC-17W5	DCM17W5SA197	DCM17W5SK126	DCM17W5PK87	DCM17W5PK127
DC-21WA4	DCM21WA4SA197	DCM21WA4SK126	DCM21WA4PK87	DCM21WA4PK127
DC-25W3	DCM25W3SA197	DCM25W3SK126	DCM25W3PK87	DCM25W3PK127
DC-27W2	DCM27W2SA197	DCM27W2SK126	DCM27W2PK87	DCM27W2PK127
DD-24W7	DDM24W7SA197	DDM24W7SK126	DDM24W7PK87	DDM24W7PK127
DD-36W4	DDM36W4SA197	DDM36W4SK126	DDM36W4PK87	DDM36W4PK127
DD-43W2	DDM43W2SA197	DDM43W2SK126	DDM43W2PK87	DDM43W2PK127
DD-47W1	DDM47W1SA197	DDM47W1SK126	DDM47W1PK87	DDM47W1PK127

Highlighted part numbers indicate standard product; usually available with shorter lead times.

## Contact Arrangements

(Will accommodate Removable Coax, Power and/or High Voltage Contacts)

Note: Color Code — Pin Connector: Red, Socket Connector: Blue

Shell Size	E	A	A	A	B	B
Contact Arrangement	5W1	3W3	7W2	11W1	5W5	9W4
No. of Signal Contacts	4 #20	0	5 #20	10 #20	0	5 #20
No. of Coaxial Contacts	1	3	2	1	5	4
Shell Size	B	B	B	C		
Contact Arrangement	13W3	17W2	21W1	8W8		
No. of Signal Contacts	10 #20	15 #20	20 #20	0		
No. of Coaxial Contacts	3	2	1	8		
Shell Size	C	C	C	C		
Contact Arrangement	13W6	17W5	21WA4	25W3		
No. of Signal Contacts	7 #20	12 #20	17 #20	22 #20		
No. of Coaxial Contacts	6	5	4	3		
Shell Size	C	D	D			
Contact Arrangement	27W2	36W4	43W2			
No. of Signal Contacts	25 #20	32 #20	41 #20			
No. of Coaxial Contacts	2	4	2			
Shell Size	D	D				
Contact Arrangement	24W7	47W1				
No. of Signal Contacts	17 #20	46 #20				
No. of Coaxial Contacts	7	1				

**ITT Cannon**

Dimensions are shown in inches (millimeters).  
Dimensions subject to change.

For technical assistance, price or delivery information, call your local technical sales office or distributor.