

SHINDENGEN

Schottky Rectifiers (SBD)

Dual

DF30PC3M

30V 30A

FEATURES

- SMT
- Super low $V_F=0.4V$
- High current capacity with Small Package

APPLICATION

- Reversed Battery Connection Protection
- DC OR output
- DC/DC converter
- Mobile telephone, personal computer

OUTLINE DIMENSIONS

Case : STO-220

Unit : mm

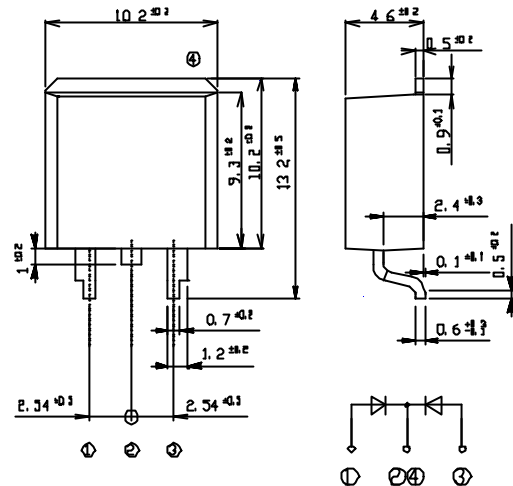

RATINGS

Absolute Maximum Ratings (If not specified $T_c=25$)

Item	Symbol	Conditions	Ratings	Unit
Storage Temperature	T_{stg}		-55 ~ 125	
Operating Junction Temperature	T_j		125	
Maximum Reverse Voltage	V_{RM}		30	V
Repetitive Peak Surge Reverse Voltage	V_{RRSM}	Pulse width 0.5ms, duty 1/40	35	V
Average Rectified Forward Current	I_o	50Hz sine wave, R-load, Rating for each diode $I_o/2$, $T_c=97$	30	A
Peak Surge Forward Current	I_{FSM}	50Hz sine wave, Non-repetitive 1 cycle peak value, $T_j=25$	300	A

Electrical Characteristics (If not specified $T_c=25$)

Item	Symbol	Conditions	Ratings	Unit
Forward Voltage	V_F	$I_F=10A$, Pulse measurement, Rating of per diode	Max.0.4	V
Reverse Current	I_R	$V_R=V_{RM}$, Pulse measurement, Rating of per diode	Max.50	mA
Junction Capacitance	C_j	$f=1MHz$, $V_R=10V$, Rating of per diode	Typ.840	pF
Thermal Resistance	θ_{jc}	junction to case	Max.1.6	/W

DF30PC3M Forward Voltage

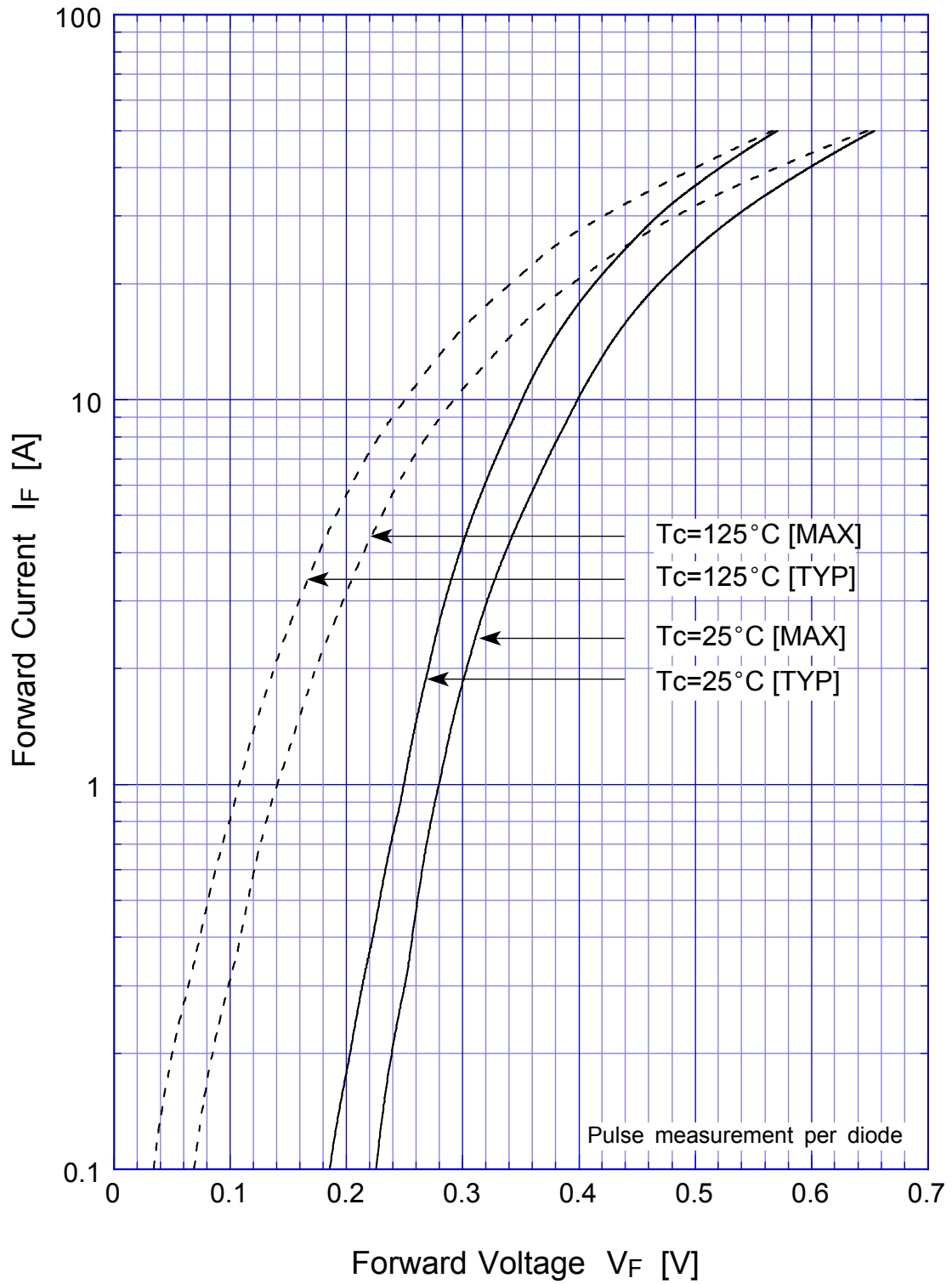

DF30PC3M Junction Capacitance

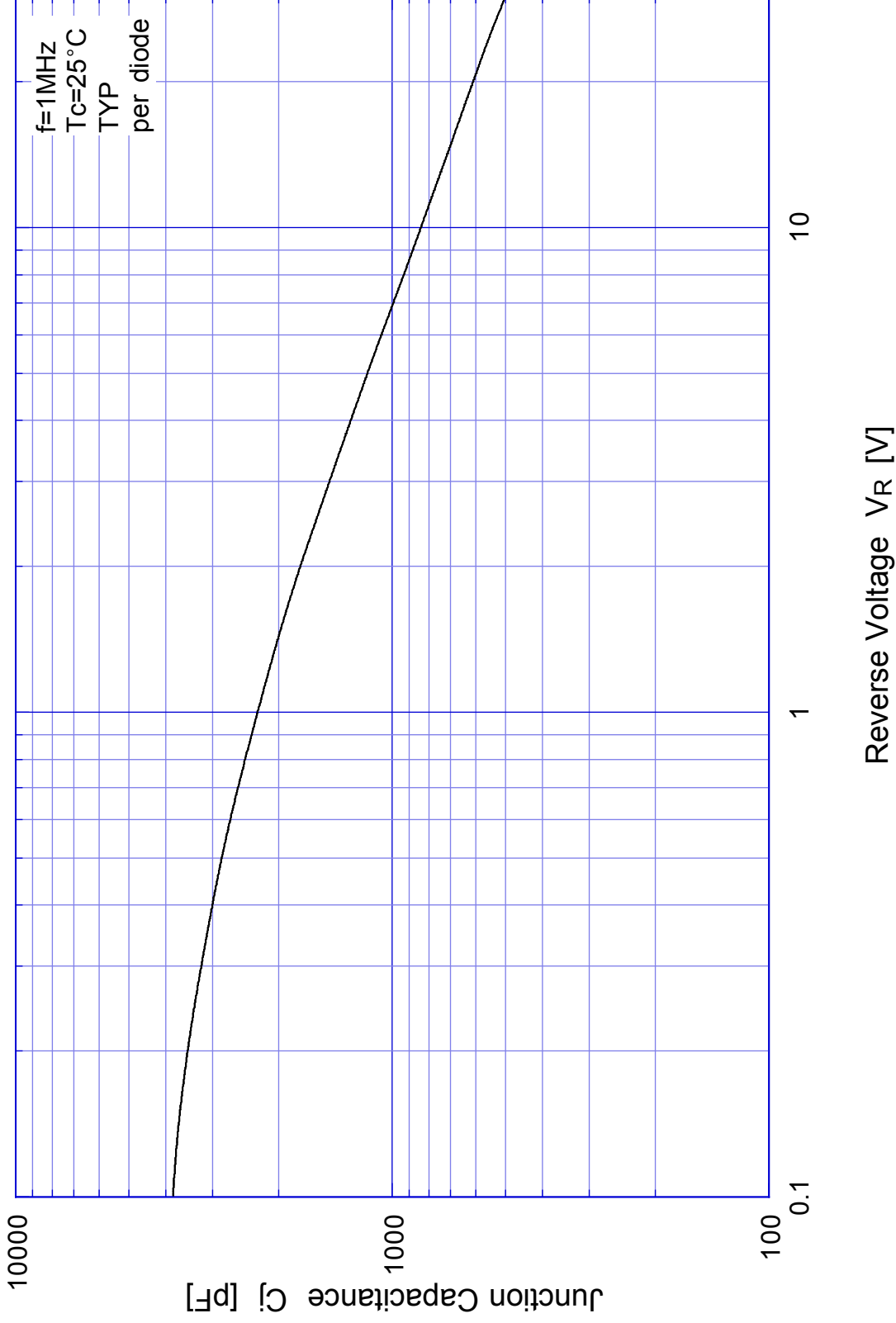

DF30PC3M Reverse Current

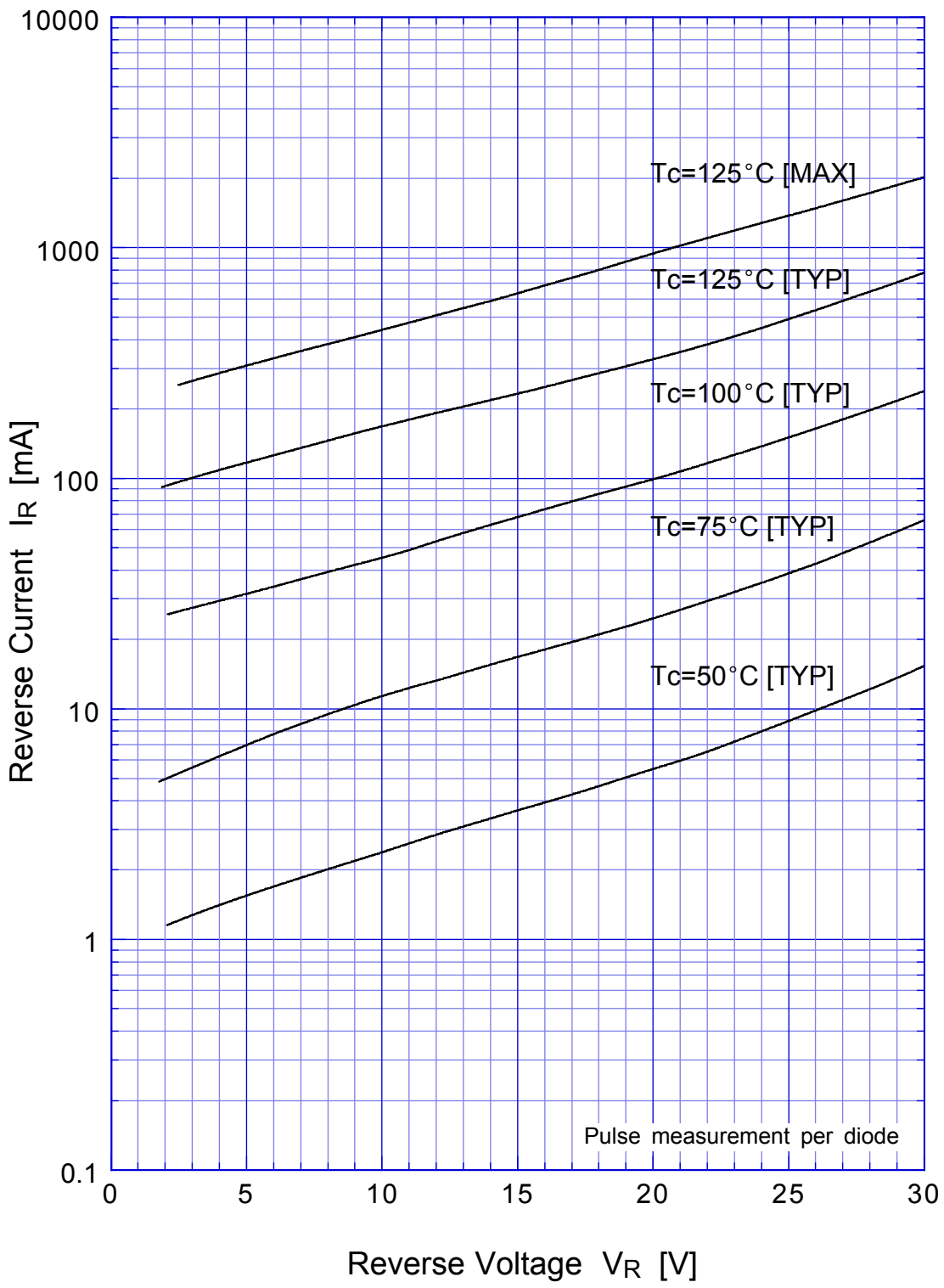

DF30PC3M Reverse Power Dissipation

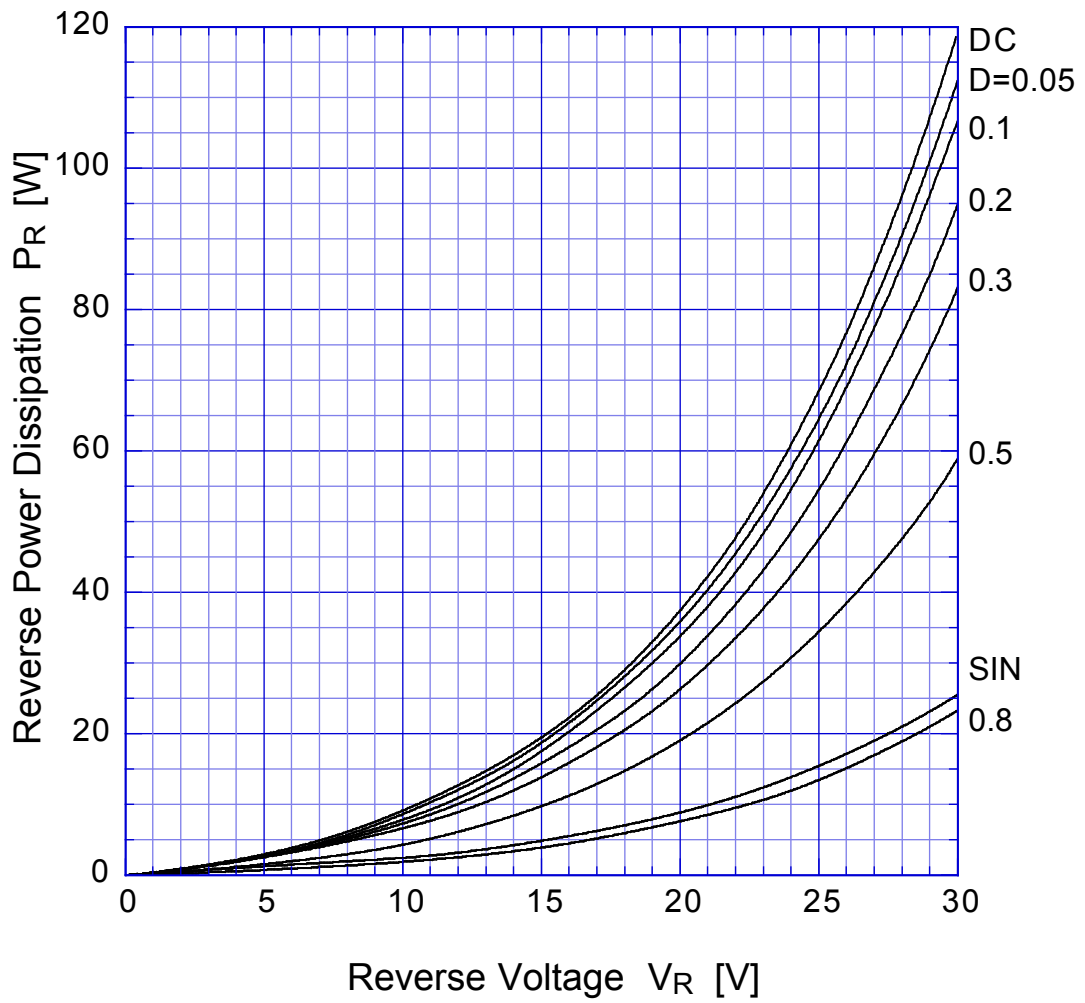

$T_j = T_{jmax}$

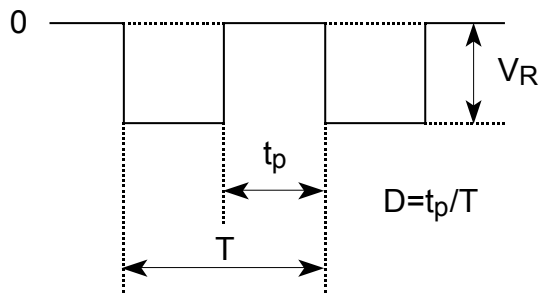

DF30PC3M Forward Power Dissipation

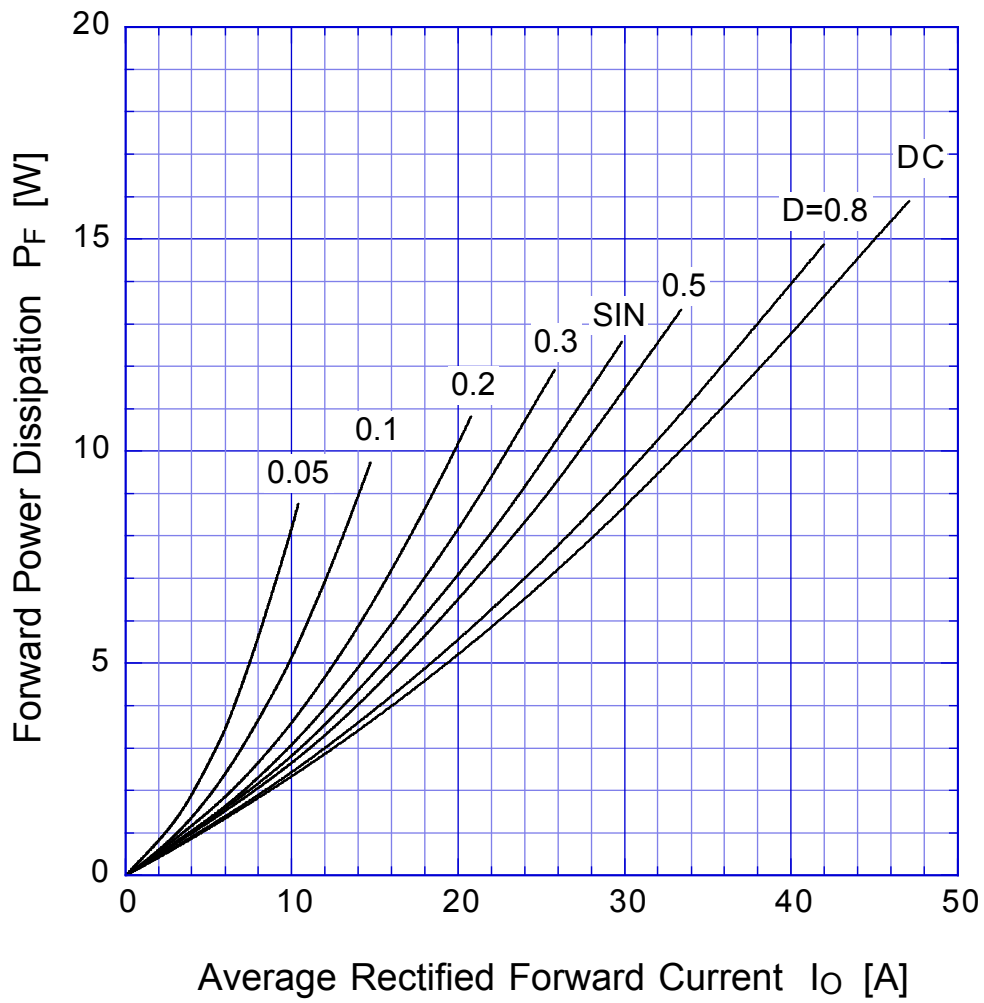

$T_j = T_{jmax}$

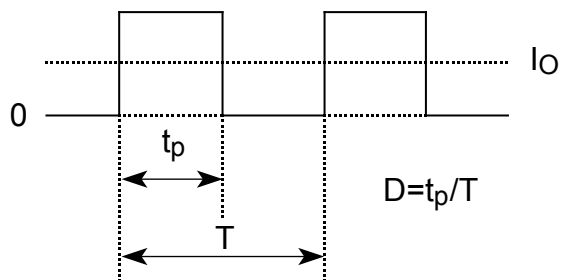

DF30PC3M

Derating Curve

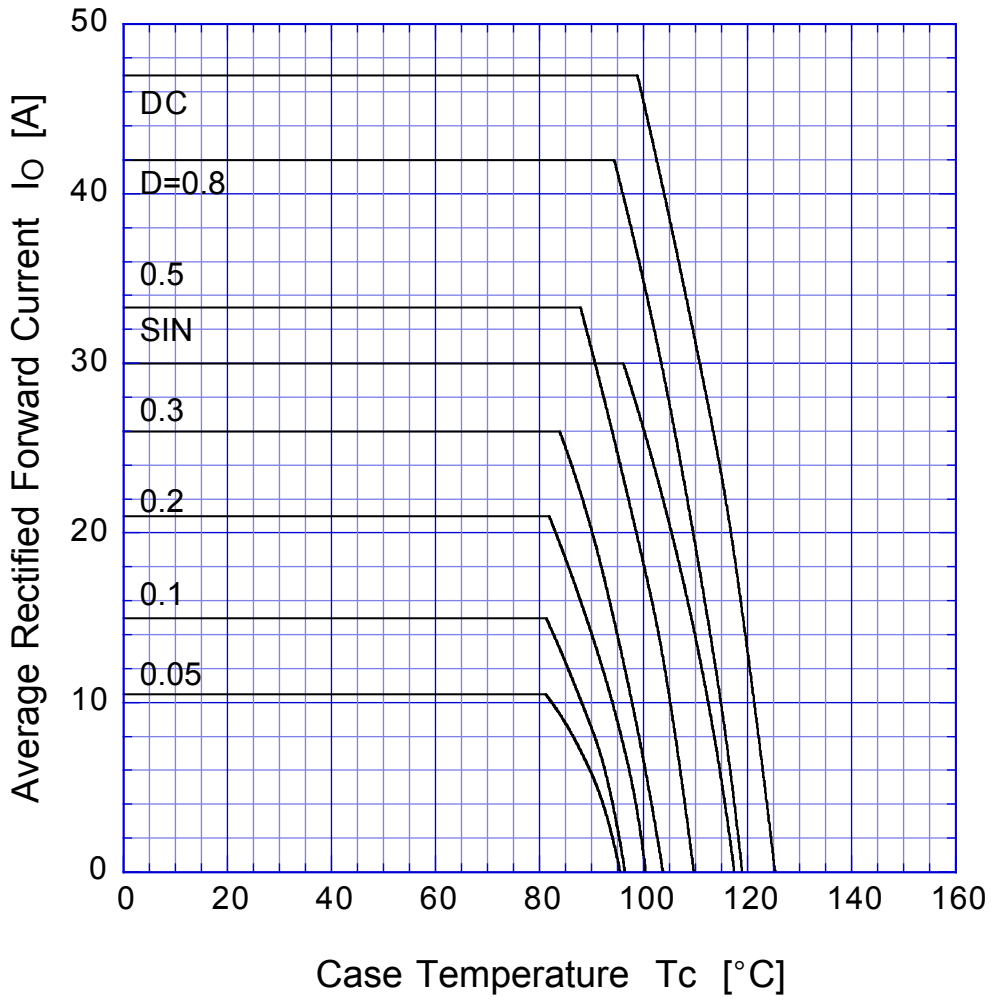

$$V_R = V_{RM}/2$$

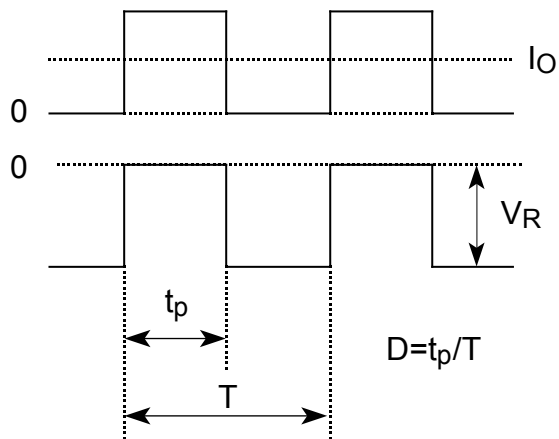

DF30PC3M Peak Surge Forward Capability

