

## 40mA 150V LED DRIVER

### FEATURES

- High reliability DFN-8 package
- 160V wide operating voltage
- Adjustable output current with constant current source
- Voltage surge suppressing—protecting LEDs
- Temperature protection function
- Simple, economical and robust device, is more suitable in micromodule
- RoHS compliant
- Apply to AC110V/AC220V power supply system
- HBM ESD 10KV min.

### APPLICATIONS

- Home appliance & industrial LED lighting
- AC lighting panels, display signboard, decorative lighting, channel indicator lamp
- Automobile: chevron side mirror marker, cluster, display instrument backlighting
- Switch contact wetting

### DFN-8

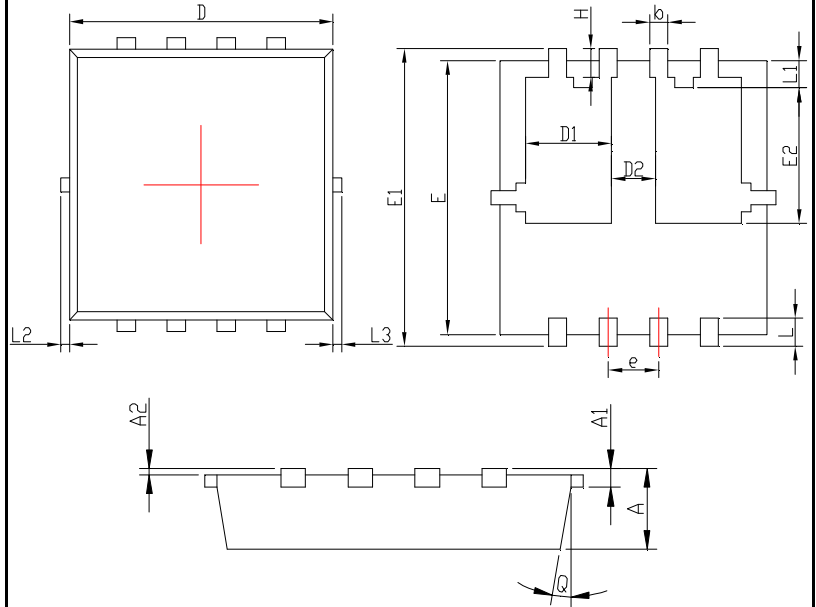

Symbol	Dimensions In Millimeters		Dimensions In Inches	
	Min.	Max.	Min.	Max.
A	0.650	0.850	0.026	0.033
A1	0.152 REF		0.006 REF	
A2	0~0.05		0~0.002	
D	2.900	3.100	0.114	0.122
D1	0.935	1.135	0.037	0.045
D2	0.280	0.480	0.011	0.019
E	2.900	3.100	0.114	0.122
E1	3.150	3.450	0.124	0.136
E2	1.535	1.935	0.060	0.076
b	0.200	0.400	0.008	0.016
e	0.550	0.750	0.022	0.030
L	0.300	0.500	0.012	0.020
L1	0.180	0.480	0.007	0.019
L2	0~0.100		0~0.004	
L3	0~0.100		0~0.004	
H	0.315	0.515	0.012	0.020
Q	9°	13°	9°	13°

### MAXIMUM RATINGS ( $T_A=25^\circ\text{C}$ unless otherwise noted)

RATING	SYMBOL	VALUE	UNIT
Anode-Cathode Voltage	$V_{ak}$ Max.	150	V
Reverse Voltage	$V_R$	500	mV
ESD Rating: Human Body Model	ESD	10000	V

### ELECTRICAL CHARACTERISTICS ( $T_A=25^\circ\text{C}$ unless otherwise noted)

CHARACTERISTICS	SYMBOL	Min.	Typ.	Max.	UNIT
Steady State Current (Regulable)	$I_{reg(SS)}$	31	40	49	mA
Pulse Current (Regulable)	$I_{reg(P)}$	33.3	44	54	mA
Capacitance@ $V_{ak}=7.5V$ , $f=1\text{MHZ}$	C		17		pF
Capacitance@ $V_{ak}=0V$ , $f=1\text{MHZ}$	C		70		pF

FIG. 1 – Steady State Current ( $I_{reg(SS)}$ ) vs Anode-Cathode Voltage ( $V_{ak}$ )

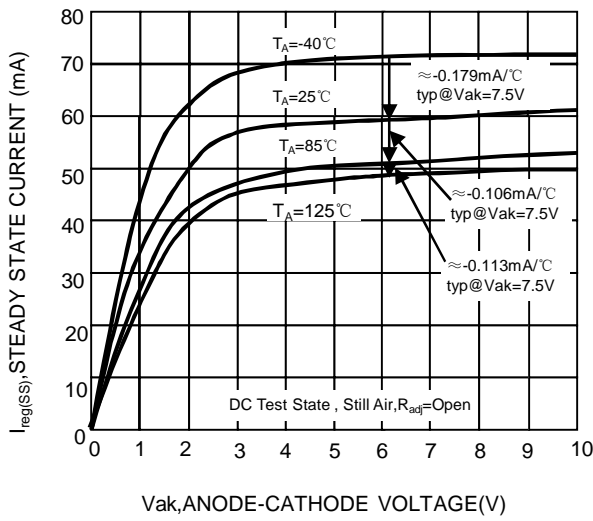

FIG. 2 – Pulse Current ( $I_{reg(p)}$ ) vs Anode-Cathode Voltage ( $V_{ak}$ )

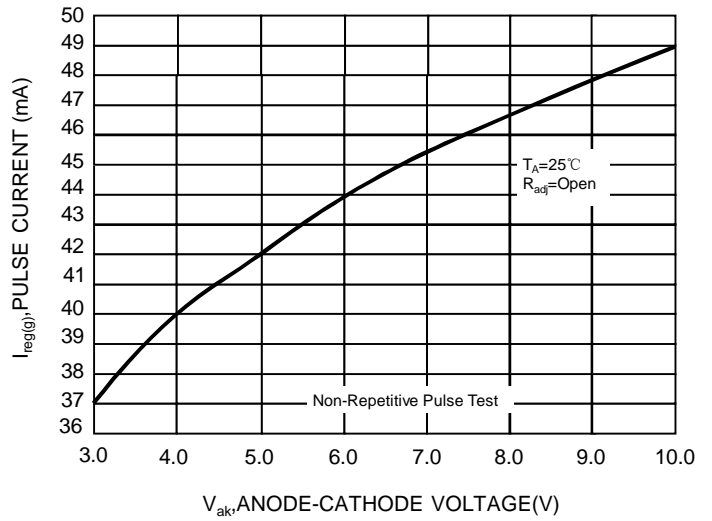

FIG. 3 – Steady State Current vs Pulse Current Testing

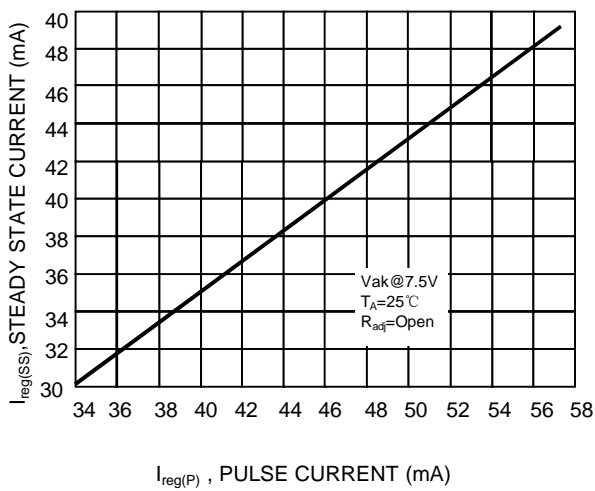

FIG. 4 – Current Regulation vs Time

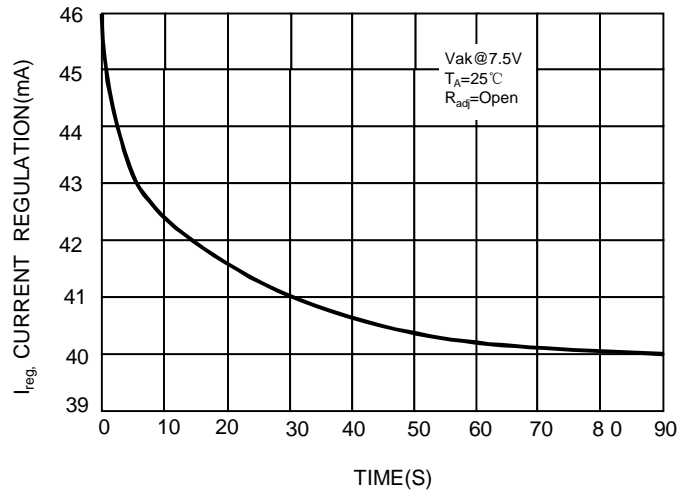
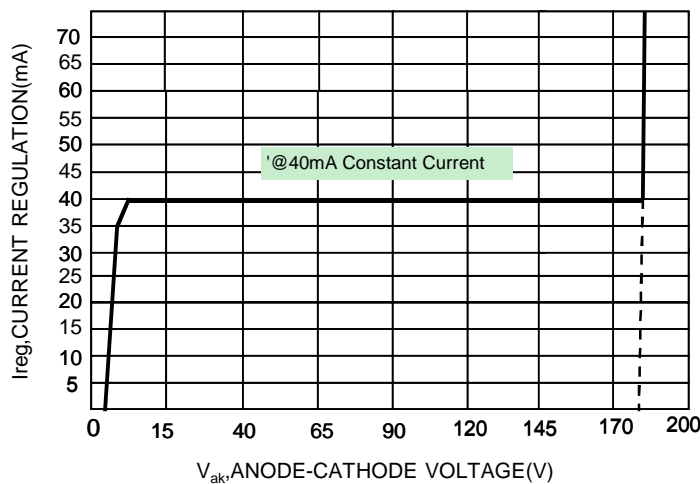
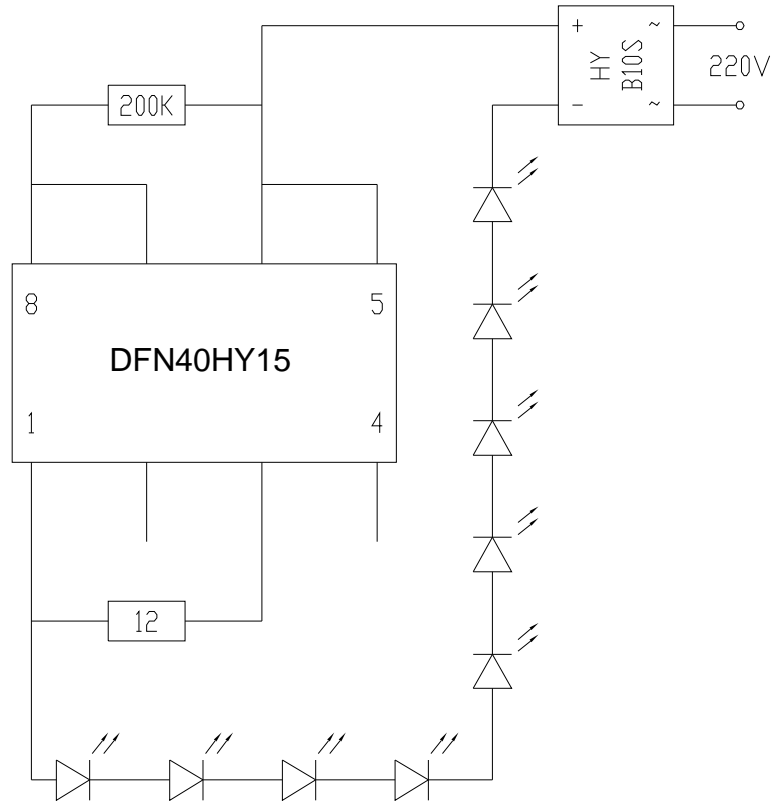

FIG. 5 – General Performance Curve



**APPLICATIONS**

Pin No.	Function	Pin No.	Function
1	Constant Current Output	5	DC Power Input
2	No Connection	6	
3	Current Adjust Resistor Input	7	Start voltage input by bias resistor
4	No Connection	8	



**SOLDERING FOOTPRINT**

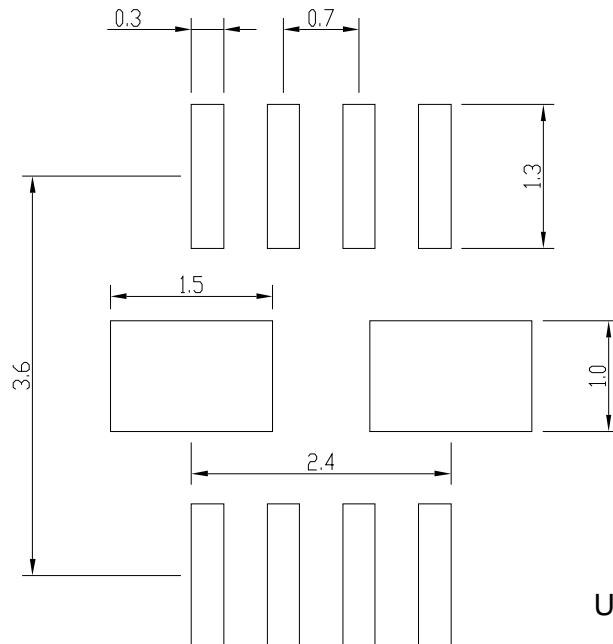

Unit:mm