

N-Channel MOSFET

Features

- Low $R_{DS(on)}$ (0.04 Ω) @ $V_{GS}=10V$
- Low Gate Charge (Typical 27nC)
- Low C_{rss} (Typical 75pF)
- Improved dv/dt Capability
- 100% Avalanche Tested
- Maximum Junction Temperature Range

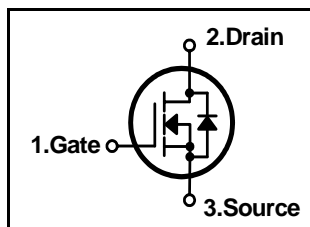

$$BV_{DSS} = 60V$$

$$R_{DS(ON)} = 0.04 \text{ ohm}$$

$$I_D = 30A$$

General Description

This N-channel enhancement mode field-effect power transistor using DI semiconductor's advanced planar stripe, DMOS technology intended for battery operated systems like a DC-DC converter motor control, ups, audio amplifier. Also, especially designed to minimize $r_{ds(on)}$, low gate charge and high rugged avalanche characteristics.

TO-220

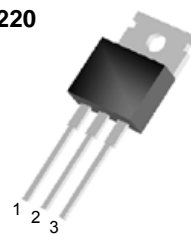

Absolute Maximum Ratings

Symbol	Parameter	Value	Units
V_{DSS}	Drain to Source Voltage	60	V
I_D	Continuous Drain Current(@ $T_C = 25^\circ C$)	30	A
	Continuous Drain Current(@ $T_C = 100^\circ C$)	21.2	A
I_{DM}	Drain Current Pulsed (Note 1)	120	A
V_{GS}	Gate to Source Voltage	± 20	V
E_{AS}	Single Pulsed Avalanche Energy (Note 2)	430	mJ
dv/dt	Peak Diode Recovery dv/dt (Note 3)	7.0	V/ns
P_D	Total Power Dissipation(@ $T_C = 25^\circ C$)	79	W
	Derating Factor above $25^\circ C$	0.53	W/ $^\circ C$
T_{STG}, T_J	Operating Junction Temperature & Storage Temperature	- 55 ~ 175	$^\circ C$
T_L	Maximum Lead Temperature for soldering purpose, 1/8 from Case for 5 seconds.	300	$^\circ C$

Thermal Characteristics

Symbol	Parameter	Value			Units
		Min.	Typ.	Max.	
$R_{\theta JC}$	Thermal Resistance, Junction-to-Case	-	-	1.90	$^\circ C/W$
$R_{\theta CS}$	Thermal Resistance, Case to Sink	-	0.5	-	$^\circ C/W$
$R_{\theta JA}$	Thermal Resistance, Junction-to-Ambient	-	-	62.5	$^\circ C/W$

DFP30N06

Electrical Characteristics (T_C = 25 °C unless otherwise noted)

Symbol	Parameter	Test Conditions	Min	Typ	Max	Units
Off Characteristics						
BV _{DSS}	Drain-Source Breakdown Voltage	V _{GS} = 0V, I _D = 250uA	60	-	-	V
BV _{DSS} /T _J	Breakdown Voltage Temperature coefficient	I _D = 250uA, referenced to 25 °C	-	0.062	-	V/°C
I _{DSS}	Zero Gate Voltage Drain Current	V _{DS} = 60V, V _{GS} = 0V	-	-	1	uA
		V _{DS} = 48V, T _C = 150 °C	-	-	10	uA
I _{GSS}	Gate-Source Leakage, Forward	V _{GS} = 20V, V _{DS} = 0V	-	-	100	nA
	Gate-Source Leakage, Reverse	V _{GS} = -20V, V _{DS} = 0V	-	-	-100	nA
On Characteristics						
V _{GS(th)}	Gate Threshold Voltage	V _{DS} = V _{GS} , I _D = 250uA	2.0	-	4.0	V
R _{DS(ON)}	Static Drain-Source On-state Resistance	V _{GS} = 10 V, I _D = 15A	-	0.029	0.04	
Dynamic Characteristics						
C _{iss}	Input Capacitance	V _{GS} = 0 V, V _{DS} = 25V, f = 1MHz	-	930	1210	pF
C _{oss}	Output Capacitance		-	290	380	
C _{rss}	Reverse Transfer Capacitance		-	75	100	
Dynamic Characteristics						
t _{d(on)}	Turn-on Delay Time	V _{DD} = 30V, I _D = 15A, R _G = 50 see fig. 13. (Note 4, 5)	-	15	40	ns
t _r	Rise Time		-	25	60	
t _{d(off)}	Turn-off Delay Time		-	60	130	
t _f	Fall Time		-	40	90	
Q _g	Total Gate Charge	V _{DS} = 48V, V _{GS} = 10V, I _D = 30A see fig. 12. (Note 4, 5)	-	27	35	nC
Q _{gs}	Gate-Source Charge		-	6.2	-	
Q _{gd}	Gate-Drain Charge(Miller Charge)		-	11.1	-	

Source-Drain Diode Ratings and Characteristics

Symbol	Parameter	Test Conditions	Min.	Typ.	Max.	Unit.
I _S	Continuous Source Current	Integral Reverse p-n Junction Diode in the MOSFET	-	-	30	A
I _{SM}	Pulsed Source Current		-	-	120	
V _{SD}	Diode Forward Voltage	I _S = 30A, V _{GS} = 0V	-	-	1.5	V
t _{rr}	Reverse Recovery Time	I _S = 30A, V _{GS} = 0V, di _F /dt = 100A/us	-	45	-	ns
Q _{rr}	Reverse Recovery Charge		-	65	-	nC

NOTES

1. Repeativity rating : pulse width limited by junction temperature
2. L = 560uH, I_{AS} = 30A, V_{DD} = 25V, R_G = 0 , Starting T_J = 25°C
3. I_{SD} 30A, di/dt 300A/us, V_{DD} BV_{DSS}, Starting T_J = 25°C
4. Pulse Test : Pulse Width 300us, Duty Cycle 2%
5. Essentially independent of operating temperature.

DFP30N06

Fig 1. On-State Characteristics

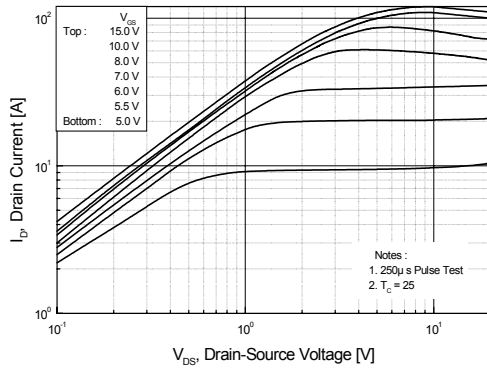

Fig 2. Transfer Characteristics

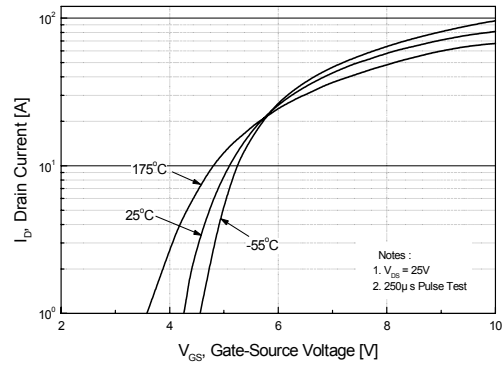

Fig 3. On Resistance Variation vs. Drain Current and Gate Voltage

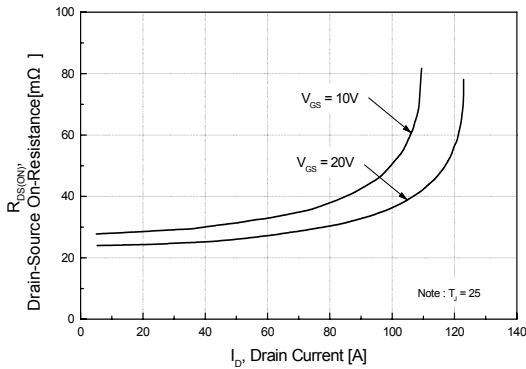

Fig 4. On State Current vs. Allowable Case Temperature

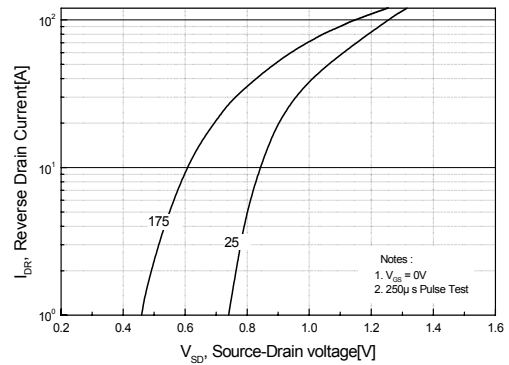

Fig 5. Capacitance Characteristics

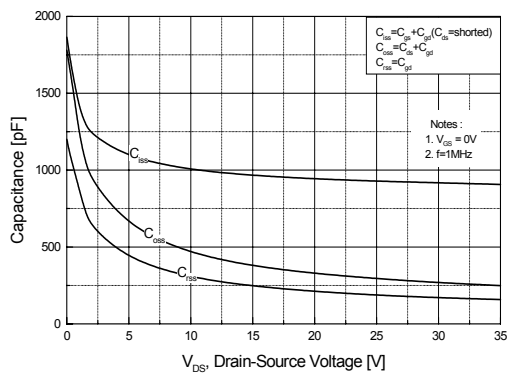
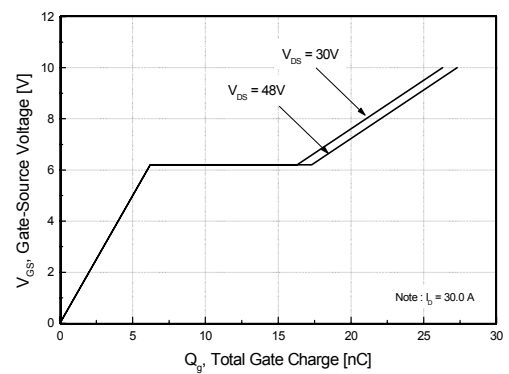

Fig 6. Gate Charge Characteristics



DFP30N06

Fig 7. Breakdown Voltage Variation vs. Junction Temperature

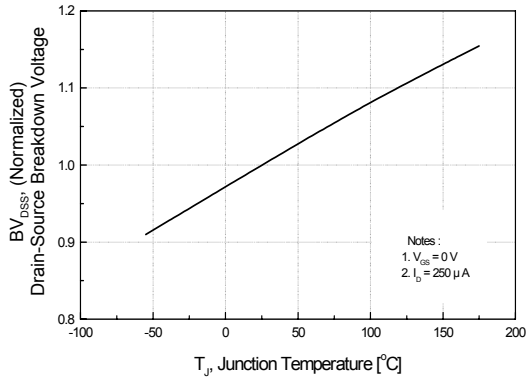

Fig 8. On-Resistance Variation vs. Junction Temperature

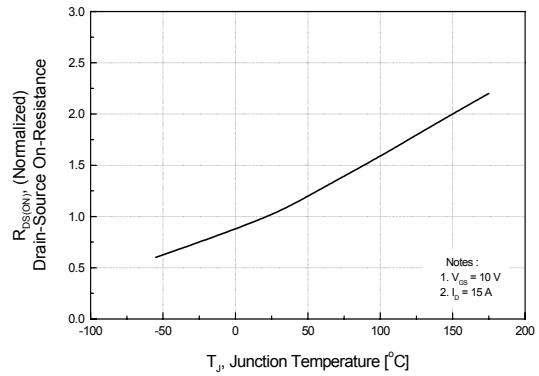

Fig 9. Maximum Safe Operating Area

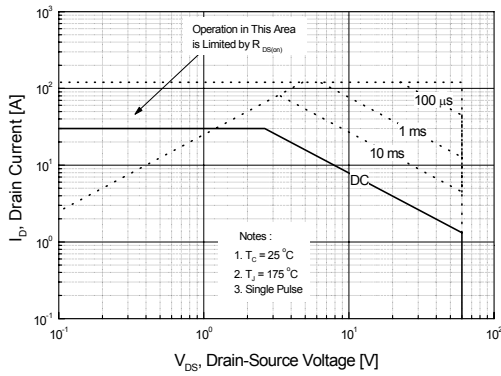

Fig 10. Maximum Drain Current vs. Case Temperature

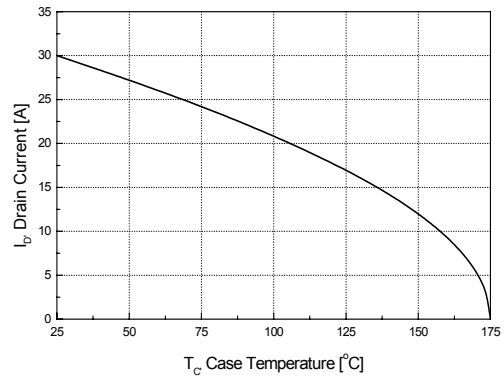
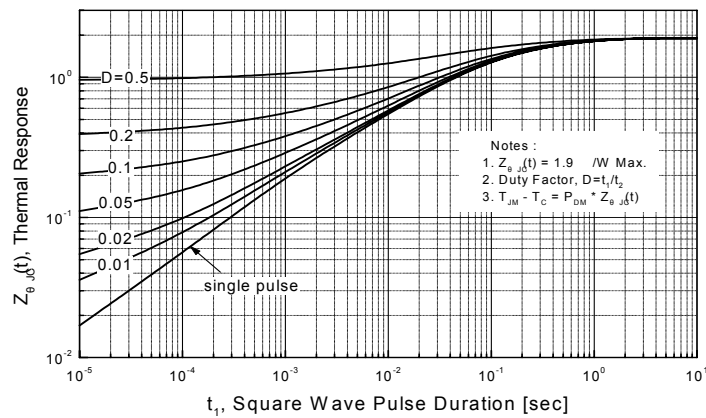

Fig 11. Transient Thermal Response Curve



DFP30N06

Fig. 12. Gate Charge Test Circuit & Waveforms

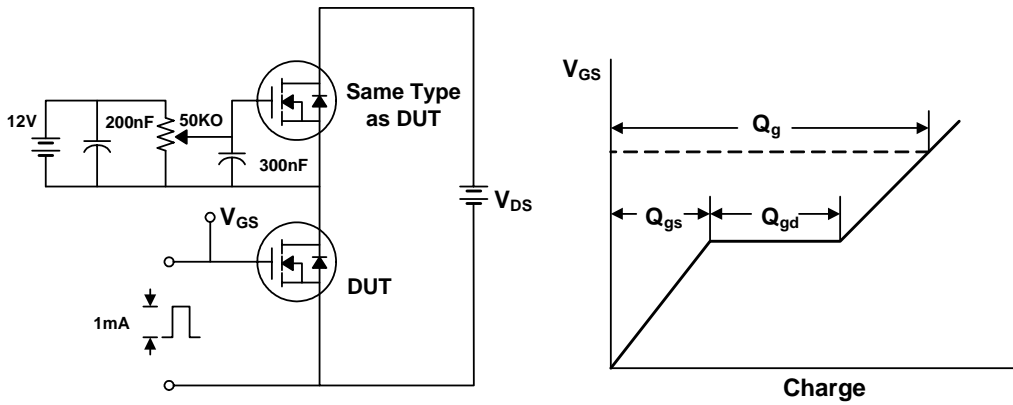

Fig 13. Switching Time Test Circuit & Waveforms

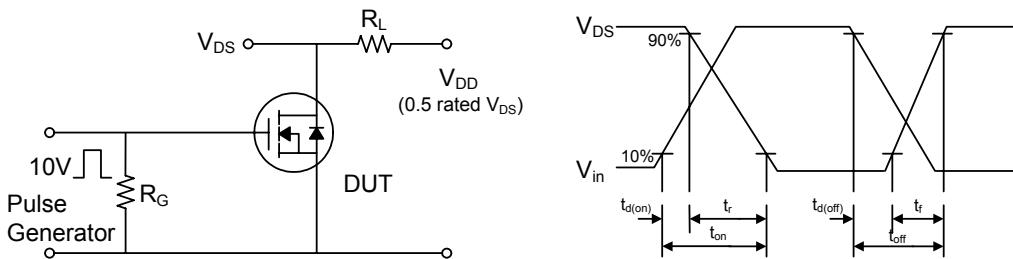
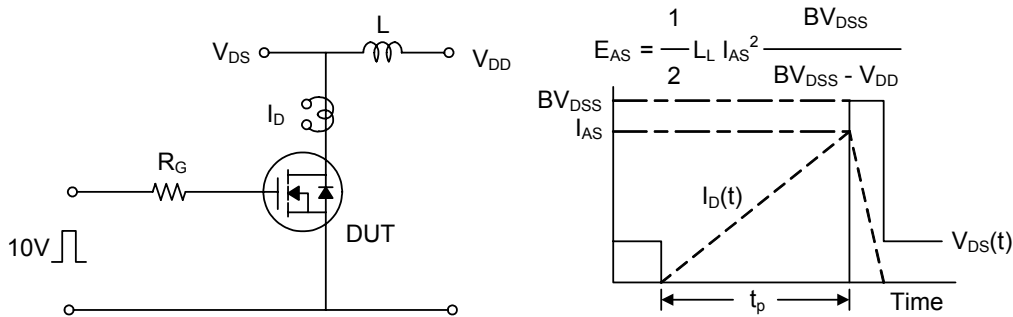
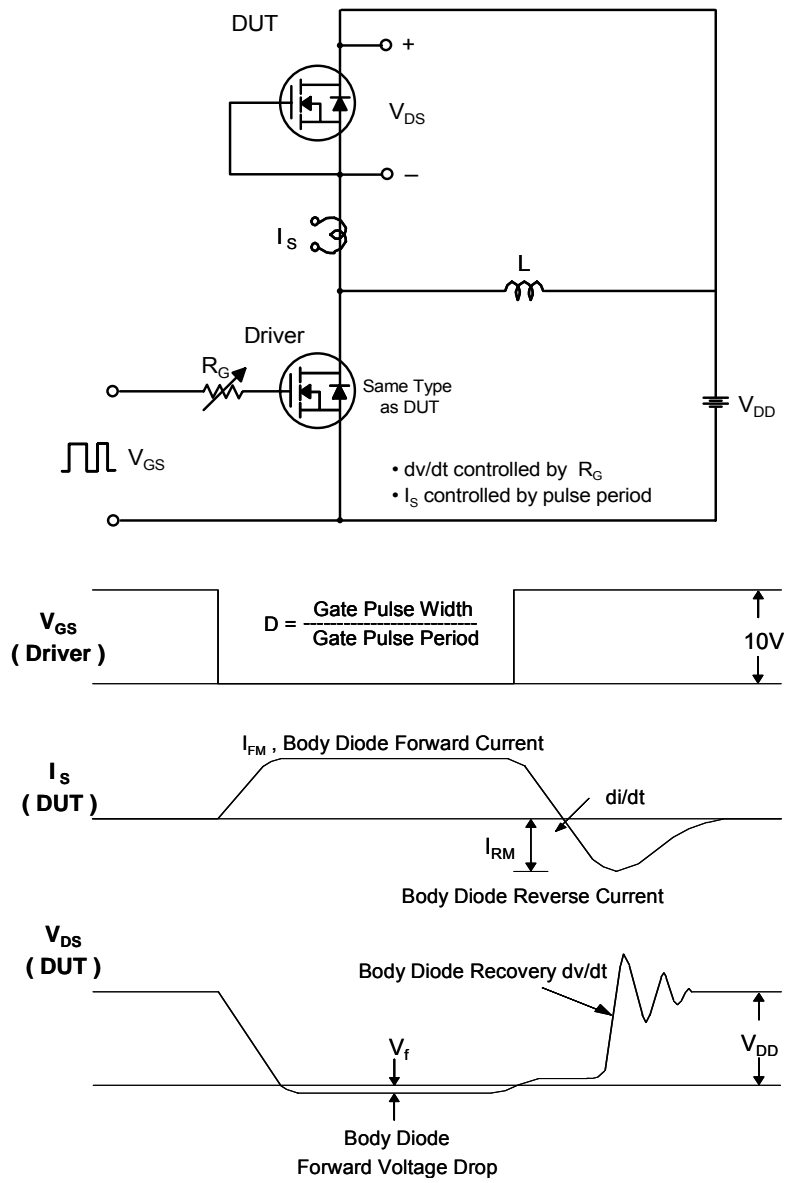

Fig 14. Unclamped Inductive Switching Test Circuit & Waveforms



DFP30N06

Fig. 15. Peak Diode Recovery dv/dt Test Circuit & Waveforms



DFP30N06

TO-220 Package Dimension

Dim.	mm			Inch		
	Min.	Typ.	Max.	Min.	Typ.	Max.
A	6.12	6.32	6.52	0.241	0.249	0.257
B	9.00	9.20	9.40	0.354	0.362	0.370
C	12.88	13.08	13.28	0.507	0.515	0.523
D	2.70	2.80	2.90	0.106	0.110	0.114
E	1.20	1.30	1.40	0.047	0.051	0.055
F	15.12	15.52	15.92	0.595	0.611	0.627
G	2.70	3.00	3.30	0.106	0.118	0.130
H	4.30	4.50	4.70	0.169	0.177	0.185
I	1.25	1.30	1.40	0.049	0.051	0.055
J	0.45	0.50	0.60	0.018	0.020	0.024
K	2.30	2.40	2.50	0.091	0.094	0.098
L		9.90			0.390	
M	1.42	1.52	1.62	0.056	0.060	0.064
N	0.75	0.85	0.95	0.030	0.033	0.037
O	2.44	2.54	2.64	0.096	0.100	0.104
P	4.88	5.08	5.28	0.192	0.200	0.208
		3.60			0.142	

