

Standard Sinterglass Diode

Features

- Specially designed for clamping circuits, horizontal deflection systems and damper applications
- High temperature metallurgically bonded construction
- Cavity-free glass passivated junction
- 1.5 ampere operation at $T_{amb} = 50\text{ }^{\circ}\text{C}$ with no thermal runaway
- Hermetically sealed package

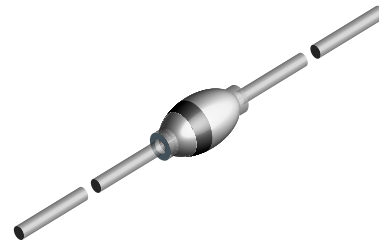

17031

Mechanical Data

Case: DO-204AP Sintered glass case

Terminals: Solder plated axial leads, solderable per MILSTD- 750, Method 2026

Polarity: Color band denotes cathode end

Mounting Position: Any

Weight: approx. 560 mg

Parts Table

Part	Type differentiation	Package
CG1	$V_{RRM} = 1400\text{ V}$	DO-204AP(G-1)
DG1	$V_{RRM} = 1500\text{ V}$	DO-204AP(G-1)

Absolute Maximum Ratings

$T_{amb} = 25\text{ }^{\circ}\text{C}$, unless otherwise specified

Parameter	Test condition	Part	Symbol	Value	Unit
Reverse voltage = Repetitive peak reverse voltage	see electrical characteristics	CG1	$V_R = V_{RRM}$	1400	V
		DG1	$V_R = V_{RRM}$	1500	V
Maximum average forward rectified current	0.375 " (9.5 mm) lead length at $T_{amb} = 50\text{ }^{\circ}\text{C}$		$I_{F(AV)}$	1.5	A
Peak forward surge current	8.3 ms single half sine wave superimposed on rated load (JEDEC Method)		I_{FSM}	40	A
Maximum full load reverse current full cycle average	0.375 " (9.5 mm) lead length at $T_{amb} = 100\text{ }^{\circ}\text{C}$		$I_{R(AV)}$	50	μA
Operating junction and storage temperature range			T_J, T_{STG}	- 55 to + 175	$^{\circ}\text{C}$

Maximum Thermal Resistance

$T_{amb} = 25\text{ }^{\circ}\text{C}$, unless otherwise specified

Parameter	Test condition	Symbol	Value	Unit
Typical thermal resistance ¹⁾		$R_{\theta JA}$	55	K/W

¹⁾ Thermal resistance from junction to ambient at 0.375 " (9.5 mm) lead length, P.C.B. mounted

Electrical Characteristics

$T_{amb} = 25\text{ }^{\circ}\text{C}$, unless otherwise specified

Parameter	Test condition	Part	Symbol	Min	Typ.	Max	Unit
Maximum instantaneous forward voltage	$I_F = 1.0\text{ A}$		V_F			1.1	V
Maximum reverse current	$V_R = V_{RRM}, T_{amb} = 25\text{ }^{\circ}\text{C}$		I_R			5.0	μA
	$V_R = V_{RRM}, T_{amb} = 100\text{ }^{\circ}\text{C}$		I_R			100	μA
Maximum reverse recovery time	$I_F = 0.5\text{ A}, I_R = 50\text{ mA}$	CG1	t_{rr}			15	μs
		DG1	t_{rr}			20	μs
	$I_F = 0.5\text{ A}, I_R = 1.0\text{ A}, I_r = 0.25\text{ A}$	CG1	t_{rr}		0.7	1.5	μs
		DG1	t_{rr}		0.7	1.5	μs
Typical junction capacitance	$V_R = 4.0\text{ V}, f = 1\text{ MHz}$		C_j		15		pF

Typical Characteristics ($T_{amb} = 25\text{ }^{\circ}\text{C}$ unless otherwise specified)

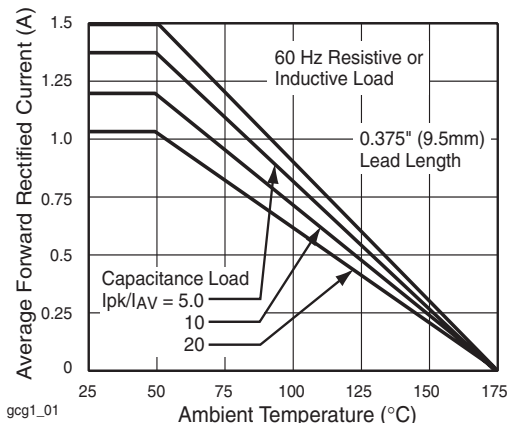

Figure 1. Forward Current Derating Curve

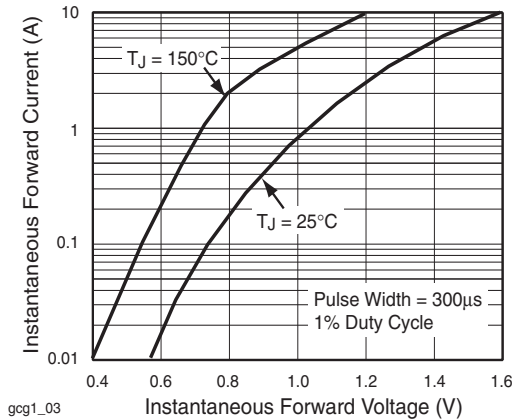

Figure 3. Typical Instantaneous Forward Characteristics

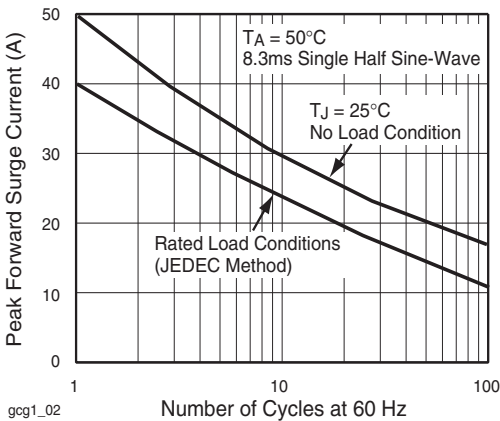

Figure 2. Maximum Non-Repetitive Peak Forward Surge Current

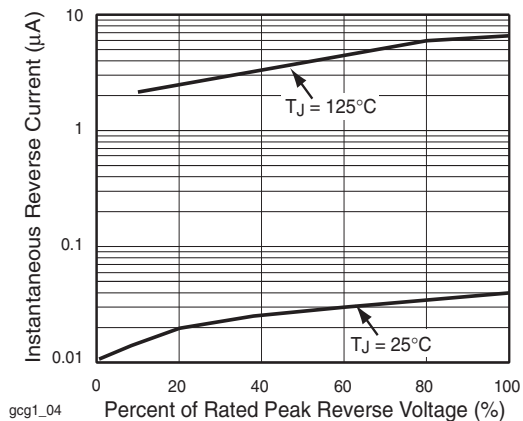

Figure 4. Typical Reverse Characteristics

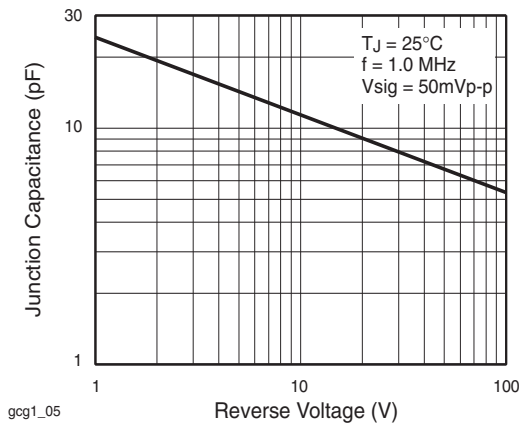
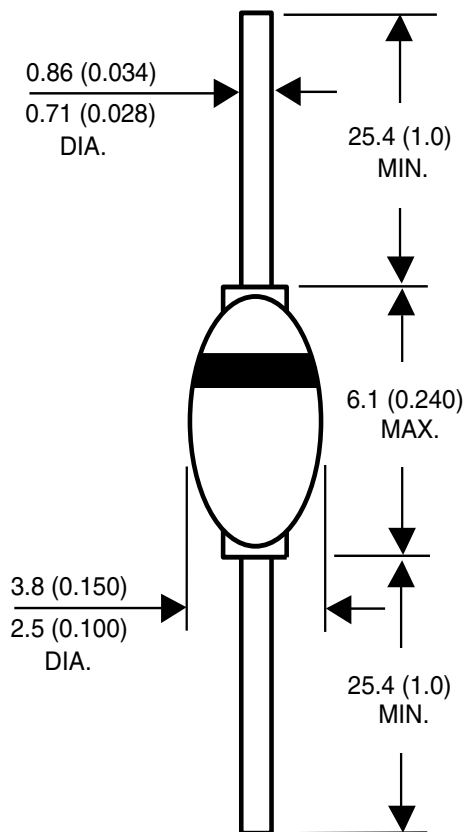

Figure 5. Typical Junction Capacitance

Package Dimensions in mm (Inches)



17030

Ozone Depleting Substances Policy Statement

It is the policy of **Vishay Semiconductor GmbH** to

1. Meet all present and future national and international statutory requirements.
2. Regularly and continuously improve the performance of our products, processes, distribution and operating systems with respect to their impact on the health and safety of our employees and the public, as well as their impact on the environment.

It is particular concern to control or eliminate releases of those substances into the atmosphere which are known as ozone depleting substances (ODSs).

The Montreal Protocol (1987) and its London Amendments (1990) intend to severely restrict the use of ODSs and forbid their use within the next ten years. Various national and international initiatives are pressing for an earlier ban on these substances.

Vishay Semiconductor GmbH has been able to use its policy of continuous improvements to eliminate the use of ODSs listed in the following documents.

1. Annex A, B and list of transitional substances of the Montreal Protocol and the London Amendments respectively
2. Class I and II ozone depleting substances in the Clean Air Act Amendments of 1990 by the Environmental Protection Agency (EPA) in the USA
3. Council Decision 88/540/EEC and 91/690/EEC Annex A, B and C (transitional substances) respectively.

Vishay Semiconductor GmbH can certify that our semiconductors are not manufactured with ozone depleting substances and do not contain such substances.

**We reserve the right to make changes to improve technical design
and may do so without further notice.**

Parameters can vary in different applications. All operating parameters must be validated for each customer application by the customer. Should the buyer use Vishay Semiconductors products for any unintended or unauthorized application, the buyer shall indemnify Vishay Semiconductors against all claims, costs, damages, and expenses, arising out of, directly or indirectly, any claim of personal damage, injury or death associated with such unintended or unauthorized use.

Vishay Semiconductor GmbH, P.O.B. 3535, D-74025 Heilbronn, Germany
Telephone: 49 (0)7131 67 2831, Fax number: 49 (0)7131 67 2423