

APPLICATIONS

The DGT409 BCA is a symmetrical GTO designed for applications which specifically require a reverse blocking capability, such as current source inverters (CSI). Reverse recovery ratings and characteristics are included.

KEY PARAMETERS

I_{TCM}	1500A
V_{DRM}/V_{DRM}	6500V
dV_D/dt	1000V/ μ s
di_T/dt	300A/ μ s

FEATURES

- Reverse Blocking Capability
- Double Side Cooling
- High Reliability In Service
- High Voltage Capability
- Fault Protection Without Fuses
- Turn-off Capability Allows Reduction In Equipment Size And Weight. Low Noise Emission Reduces Acoustic Cladding Necessary For Environmental Requirements

ORDERING INFORMATION

Order as: **DGT409BCA6565**

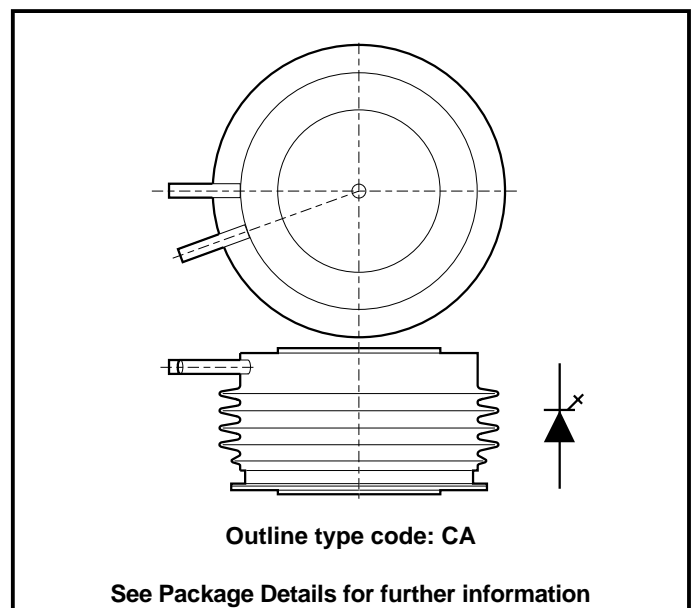

Fig. 1 Package outline

DGT409BCA

ABSOLUTE MAXIMUM RATINGS

Stresses above those listed under 'Absolute Maximum Ratings' may cause permanent damage to the device. This is a stress rating only and functional operation of the device at these or any other conditions above those indicated in the operational sections of this specification is not implied. Exposure to Absolute Maximum Ratings for extended periods may affect device reliability.

$T_j = 115^\circ\text{C}$ unless stated otherwise

Symbol	Parameter	Conditions	Max.	Units
V_{DRM}	Repetitive peak off-state voltage	$I_{\text{DM}} = 100\text{mA}$	6500	V
V_{RRM}	Repetitive peak reverse voltage	$I_{\text{RRM}} = 100\text{mA}$	6500	V
I_{TCM}	Repetitive peak controllable on-state current	$V_{\text{D}} = 4300\text{V}$, $di_{\text{GQ}}/dt = 20\text{A}/\mu\text{s}$, $C_{\text{S}} = 2.0\mu\text{F}$	1500	A
I_{TSM}	Surge (non-repetitive) on-state current	10ms half sine.	3	kA
I^2t	I^2t for fusing	10ms half sine.	45×10^3	A^2s
di_{T}/dt	Critical rate of rise of on-state current	$V_{\text{D}} = 3000\text{V}$, $I_{\text{T}} = 800\text{A}$, $I_{\text{FG}} > 20\text{A}$, $t_{\text{r}} > 1.5\mu\text{s}$	300	$\text{A}/\mu\text{s}$
dV_{D}/dt	Rate of rise of off-state voltage	$V_{\text{D}} = 3000\text{V}$, $R_{\text{GK}} \leq 1.5\Omega$	175	$\text{V}/\mu\text{s}$
		$V_{\text{D}} = 3000\text{V}$, $V_{\text{RG}} = -2\text{V}$	1000	$\text{V}/\mu\text{s}$
L_{S}	Peak stray inductance in snubber circuit	$I_{\text{T}} = 1500\text{A}$, $V_{\text{DM}} = 6000\text{V}$, $di_{\text{GQ}}/dt = 20\text{A}/\mu\text{s}$, $C_{\text{S}} = 2\mu\text{F}$	200	nH

GATE RATINGS

Symbol	Parameter	Conditions	Min.	Max.	Units
V_{RGM}	Peak reverse gate voltage	This value may be exceeded during turn-off	-	25	V
I_{FGM}	Peak forward gate current		20	70	A
$P_{\text{FG(AV)}}$	Average forward gate power		-	10	W
P_{RGM}	Peak reverse gate power		-	15	kW
di_{GQ}/dt	Rate of rise of reverse gate current		15	60	$\text{A}/\mu\text{s}$
$t_{\text{ON(min)}}$	Minimum permissible on time		50	-	μs
$t_{\text{OFF(min)}}$	Minimum permissible off time		150	-	μs
I_{RGM}	Continuous reverse gate-cathode current	$V_{\text{RGM}} = 16\text{V}$, No gate cathode resistor	-	50	mA

THERMAL RATINGS AND MECHANICAL DATA

Symbol	Parameter	Conditions	Min.	Max.	Units	
$R_{th(j-hs)}$	DC thermal resistance - junction to heatsink surface	Double side cooled	-	0.046	°C/W	
		Anode side cooled	-	0.073	°C/W	
		Cathode side cooled	-	0.124	°C/W	
$R_{th(c-hs)}$	Contact thermal resistance	Clamping force 12.0kN With mounting compound	per contact	-	0.009	°C/W
T_{vj}	Virtual junction temperature		-	115	°C	
T_{OP}/T_{stg}	Operating junction/storage temperature range		-40	115	°C	
-	Clamping force		11.0	15.0	kN	

CHARACTERISTICS

$T_j = 115^\circ\text{C}$ unless stated otherwise					
Symbol	Parameter	Conditions	Min.	Max.	Units
V_{TM}	On-state voltage	At 200A peak, $I_{G(ON)} = 4\text{A d.c.}$	-	4	V
I_{DM}	Peak off-state current	$V_{DRM} = 6500\text{V}$, $V_{RG} = 0\text{V}$	-	100	mA
I_{RRM}	Peak reverse current	At $V_{RRM} = 6500\text{V}$	-	100	mA
V_{GT}	Gate trigger voltage	$V_D = 24\text{V}$, $I_T = 100\text{A}$, $T_j = 25^\circ\text{C}$	-	1	V
I_{GT}	Gate trigger current	$V_D = 24\text{V}$, $I_T = 100\text{A}$, $T_j = 25^\circ\text{C}$	-	2	A
I_{RGM}	Reverse gate cathode current	$V_{RGM} = 16\text{V}$, No gate/cathode resistor	-	50	mA
E_{ON}	Turn-on energy	$V_D = 3000\text{V}$	-	2500	mJ
t_d	Delay time	$I_T = 400\text{A}$, $di_T/dt = 150\text{A}/\mu\text{s}$	-	3	μs
t_r	Rise time	$I_{FG} = 20\text{A}$, $t_r < 1.5\mu\text{s}$	-	7	μs
E_{OFF}	Turn-off energy		-	2500	mJ
t_{gs}	Storage time		See Figs. 16 and 17		μs
t_{gf}	Fall time	$I_T = 800\text{A}$, $V_{DM} = 3000\text{V}$	See Figs. 16 and 17		μs
t_{gq}	Gate controlled turn-off time	Snubber Cap $C_s = 2\mu\text{F}$,	See Figs. 16 and 17		μs
Q_{GQ}	Turn-off gate charge	$di_{GQ}/dt = 20\text{A}/\mu\text{s}$	-	3600	μC
Q_{GQT}	Total turn-off gate charge		-	7200	μC
I_{GQM}	Peak reverse gate current		-	350	A

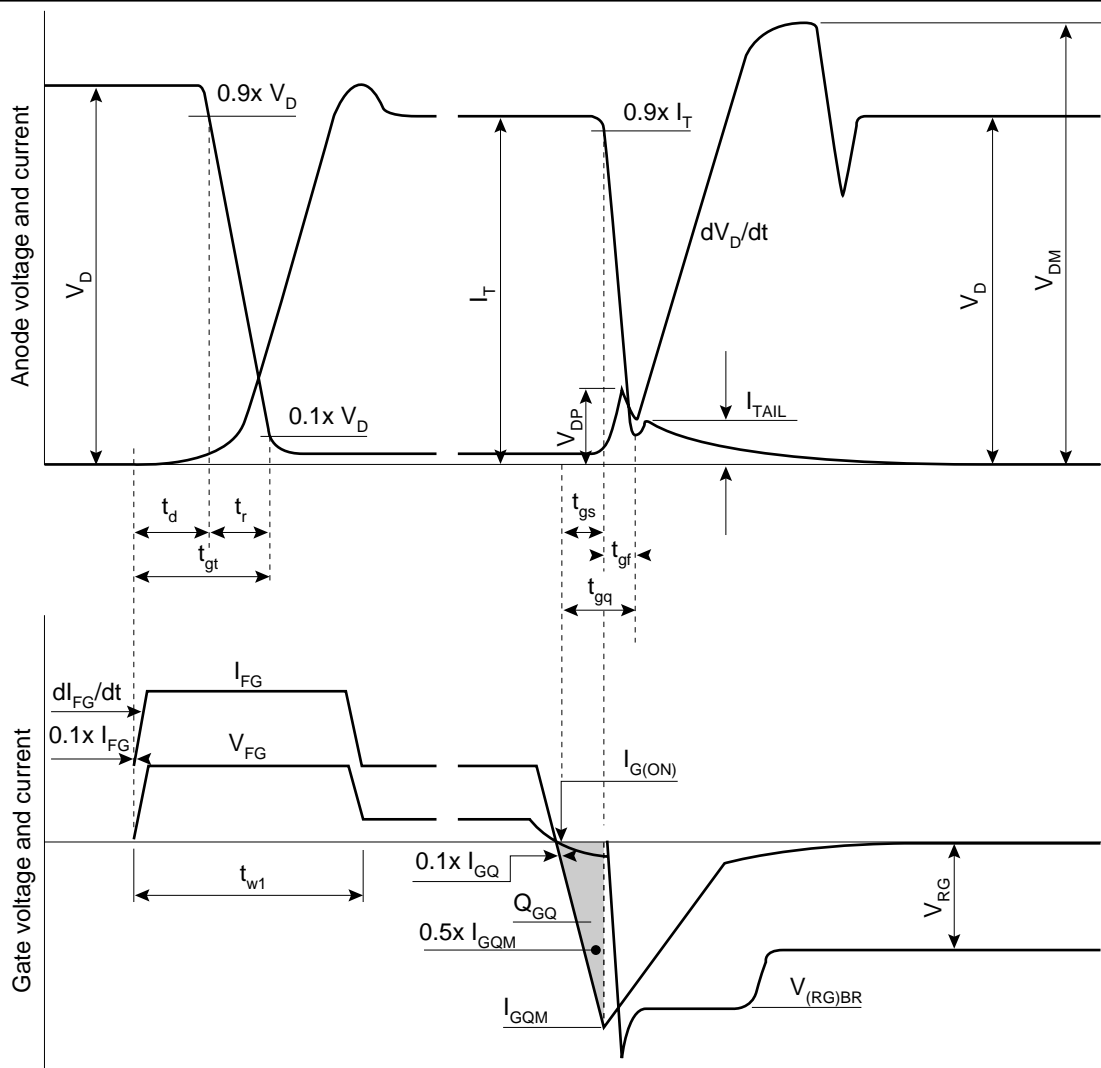

Recommended gate conditions to switch off $I_{TCM} = 800A$:

- $I_{FG} = 30A$
- $I_{G(ON)} = 4A$ d.c.
- $t_{w1(min)} = 20\mu s$
- $I_{GQM} = 270A$ typical
- $di_{GQ}/dt = 30A/\mu s$
- $Q_{GQ} = 2200\mu C$
- $V_{RG(min)} = 2V$
- $V_{RG(max)} = 15V$

These are recommended Dynex Semiconductor conditions. Other conditions are permitted according to users gate drive specifications.

Fig.2 General switching waveforms

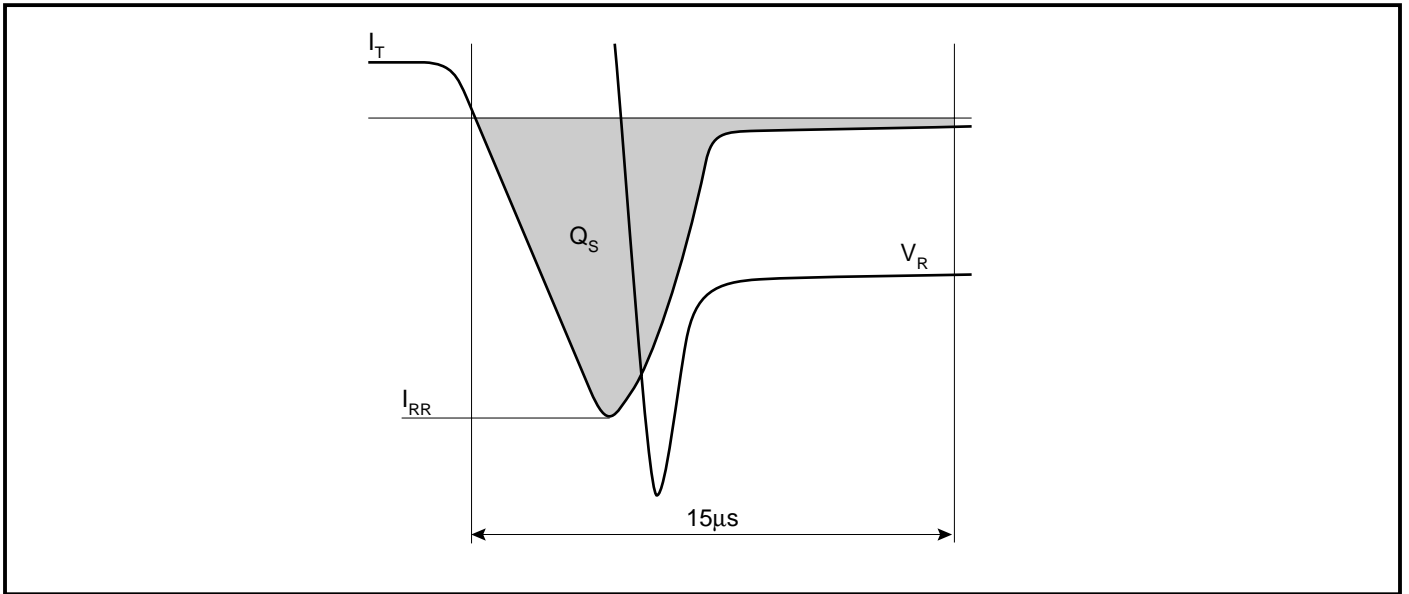

Fig.3 Reverse recovery waveforms

CURVES

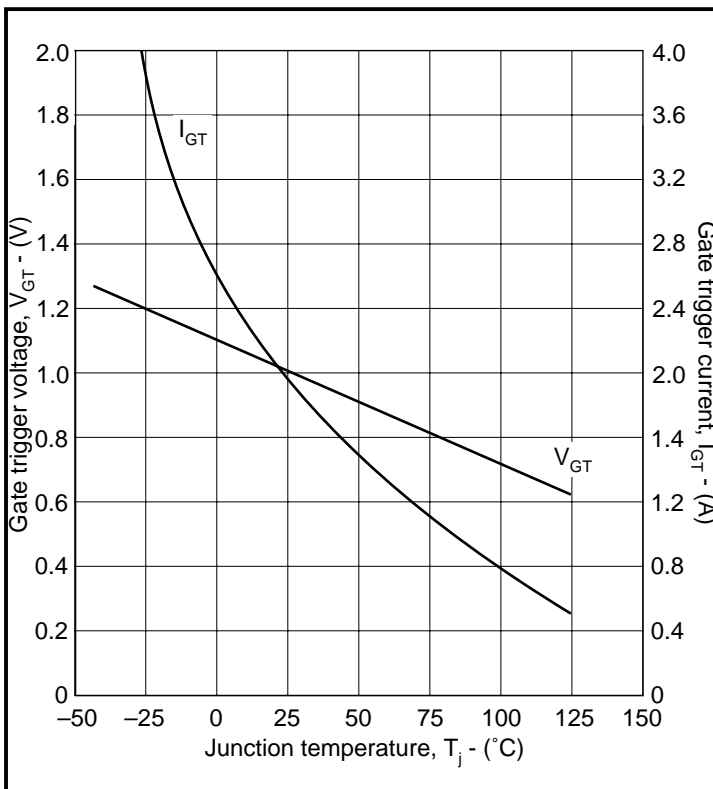

Fig.4 Maximum gate trigger voltage/current vs junction temperature

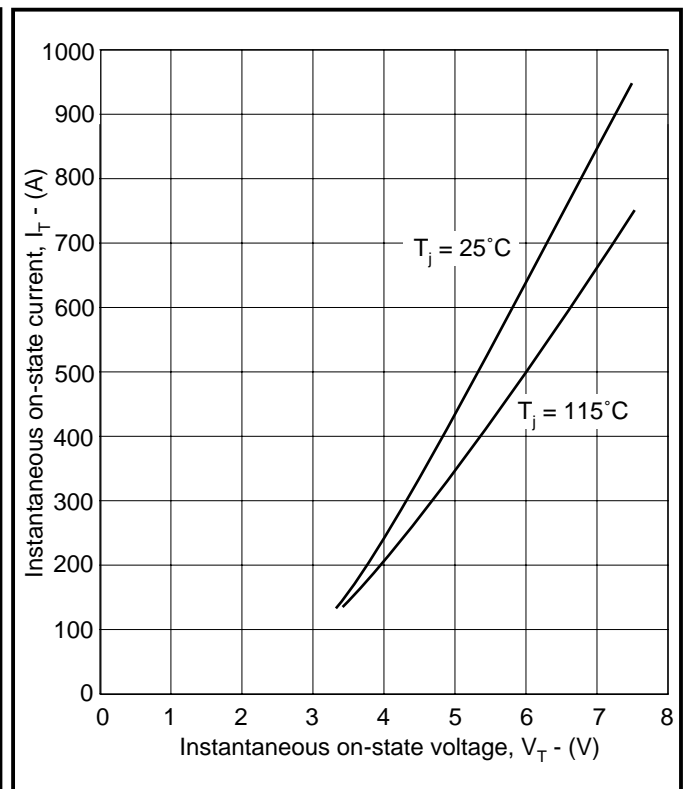

Fig.5 Maximum on-state characteristics

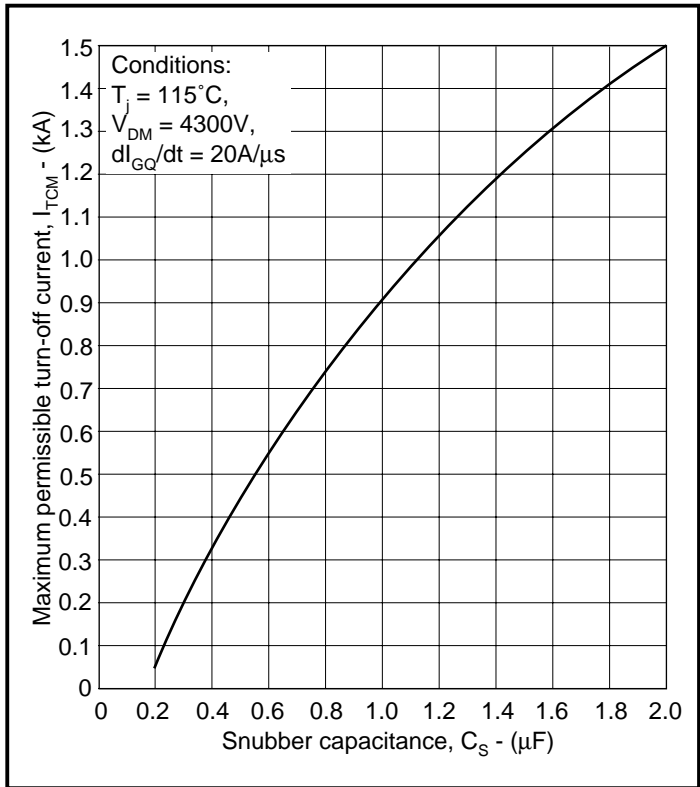

Fig.5 Maximum dependence of I_{TCM} on C_S

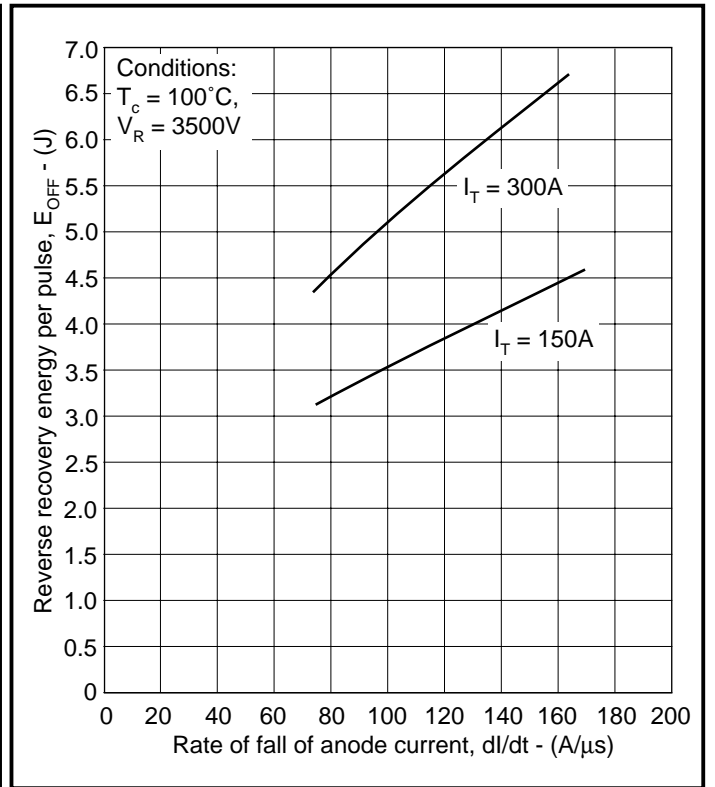

Fig.6 Maximum reverse recovery energy vs rate of fall of anode current

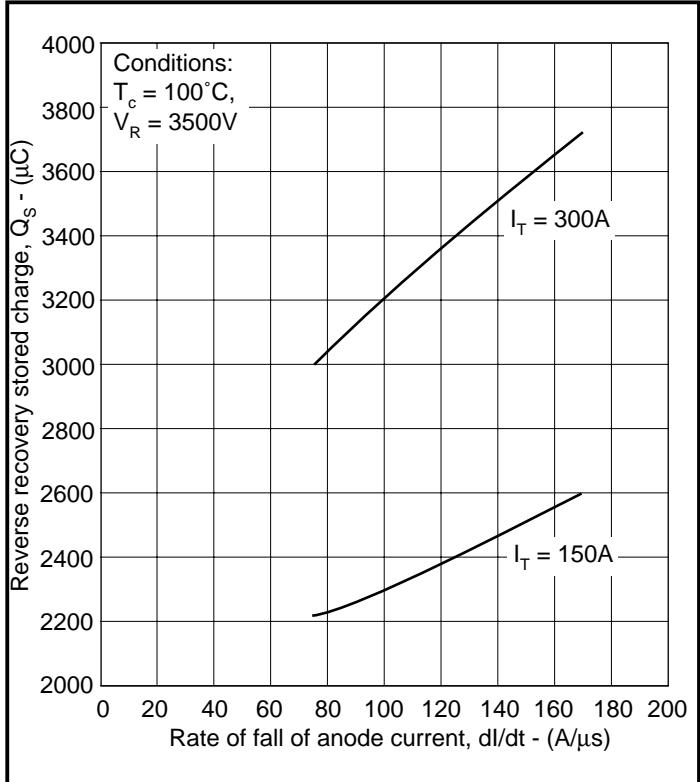

Fig.7 Maximum reverse recovery stored charge vs rate of fall of anode current

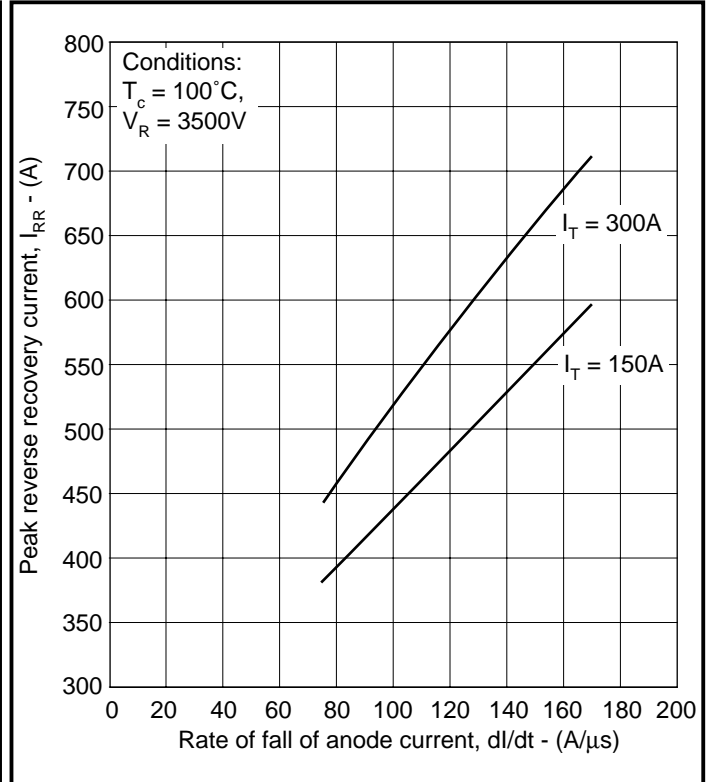

Fig.8 Maximum reverse recovery current vs rate of fall of anode current

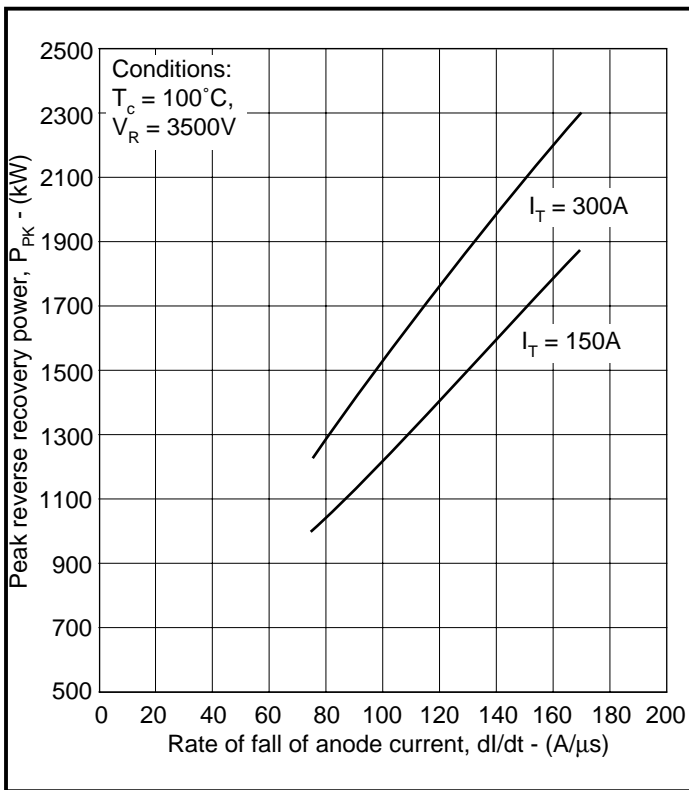

Fig.9 Maximum reverse recovery power vs rate of fall of anode current

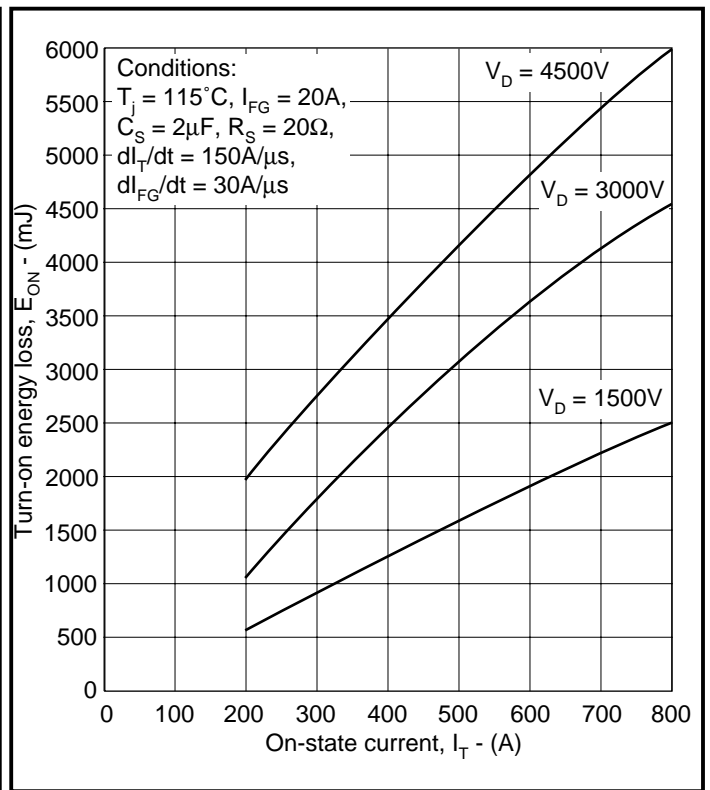

Fig.10 Turn-on energy vs on-state current

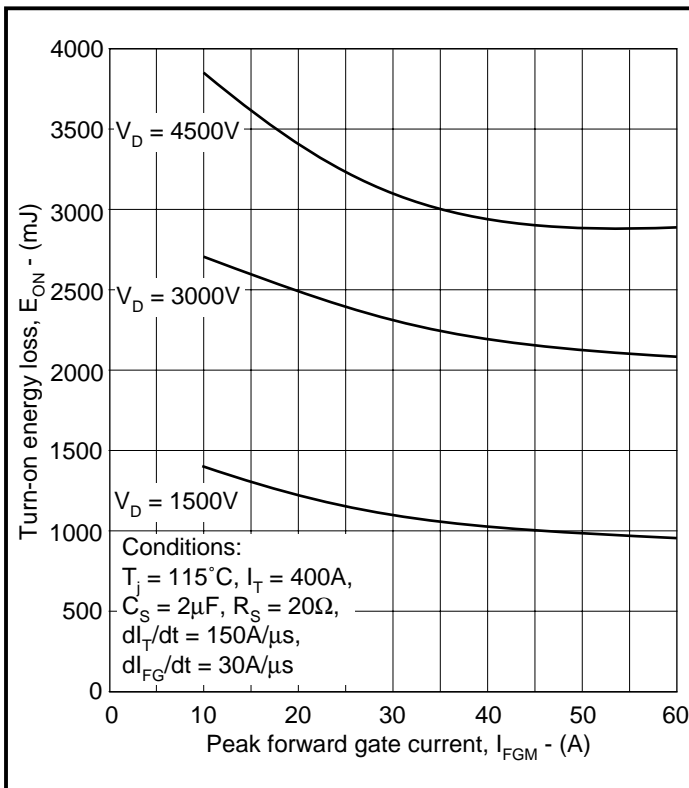

Fig.11 Turn-on energy vs peak forward gate current

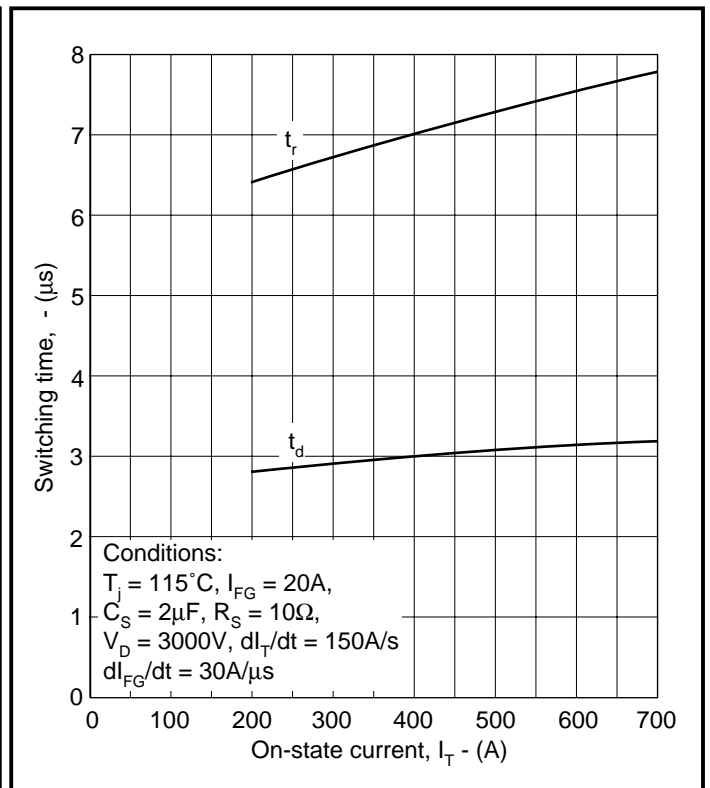

Fig.12 Delay time and rise time vs on-state current

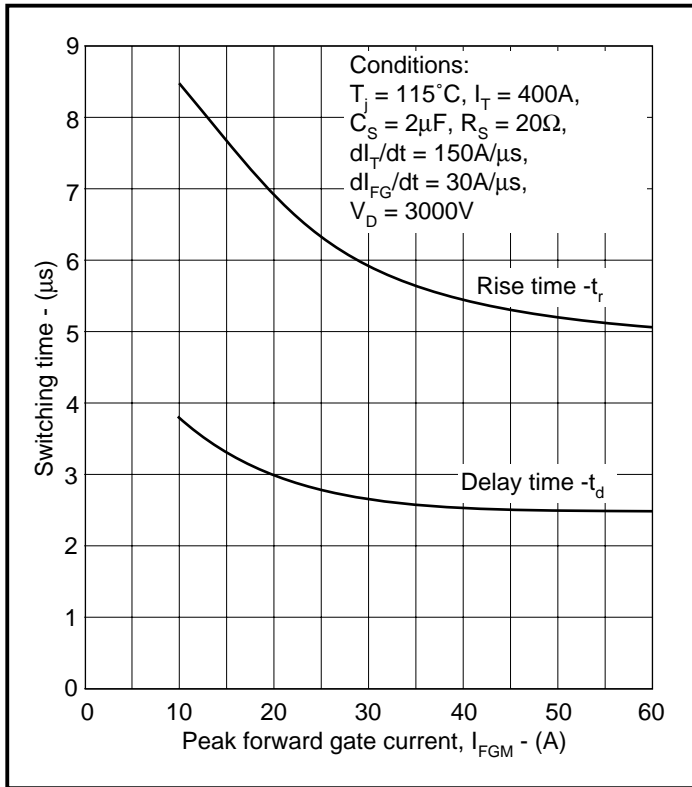

Fig.13 Switching times vs peak forward gate current

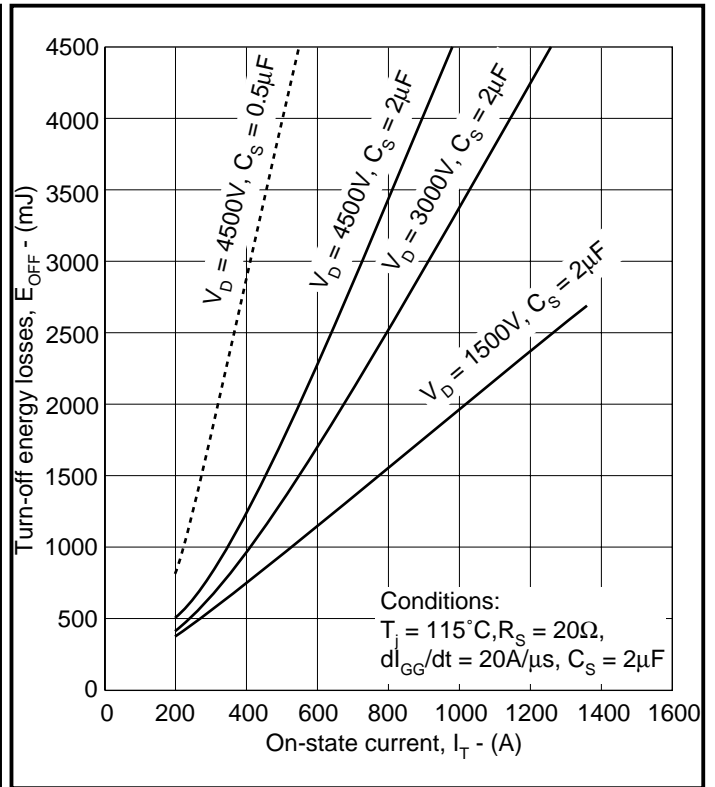

Fig.14 Maximum turn-off energy vs on-state current

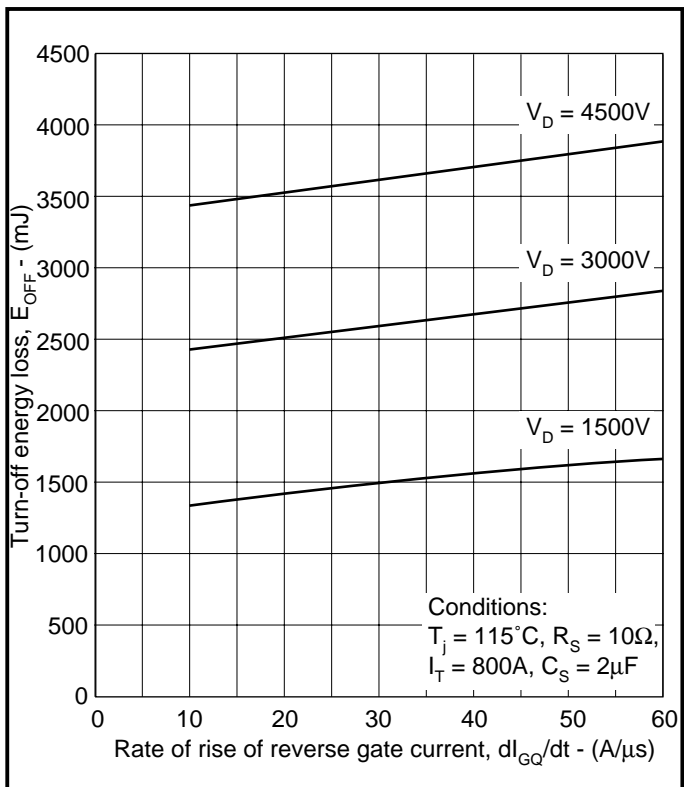

Fig.15 Turn-off energy vs rate of rise of reverse gate current

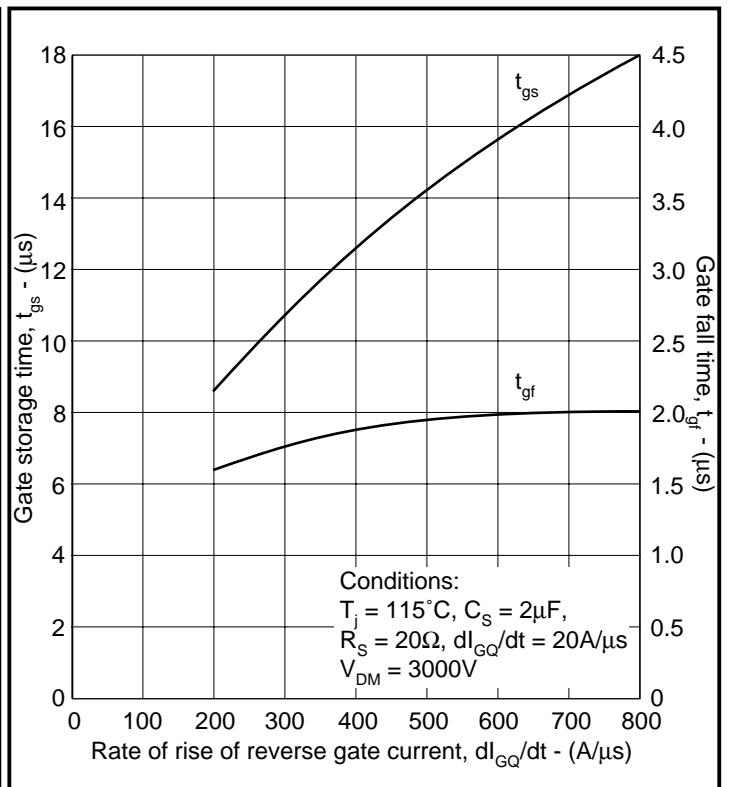

Fig.16 Gate storage time and fall time vs on-state current

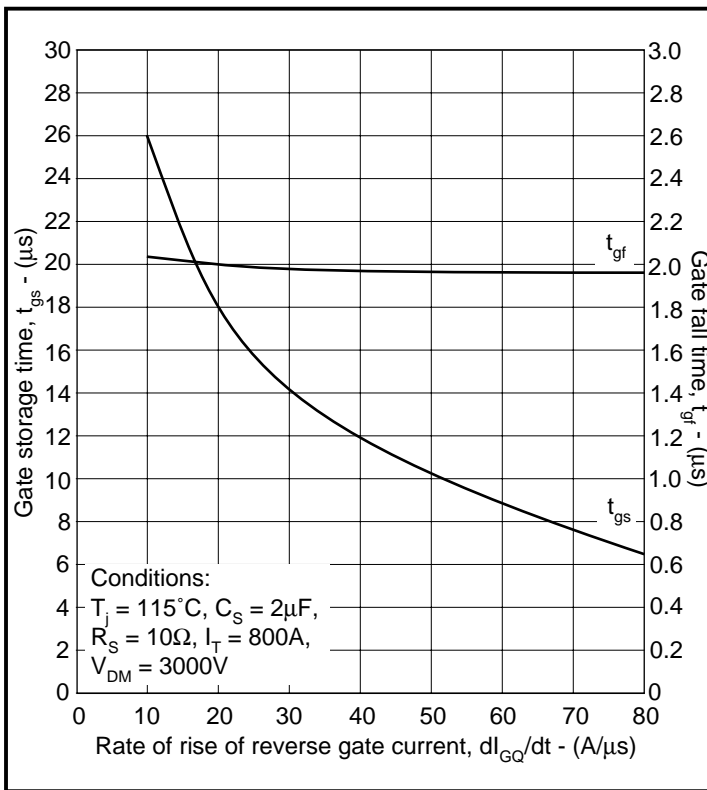

Fig.17 Gate storage time and fall time vs rate of rise of reverse gate current

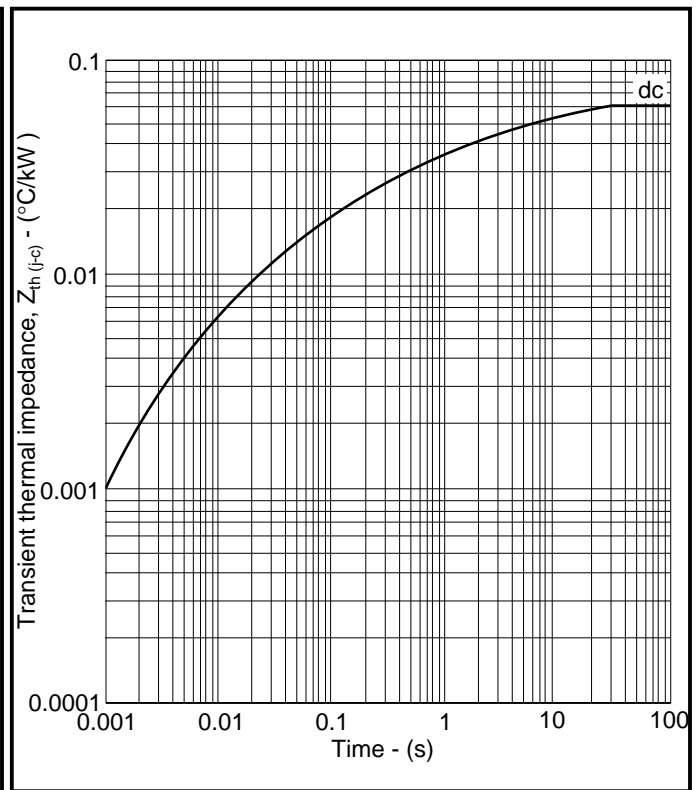
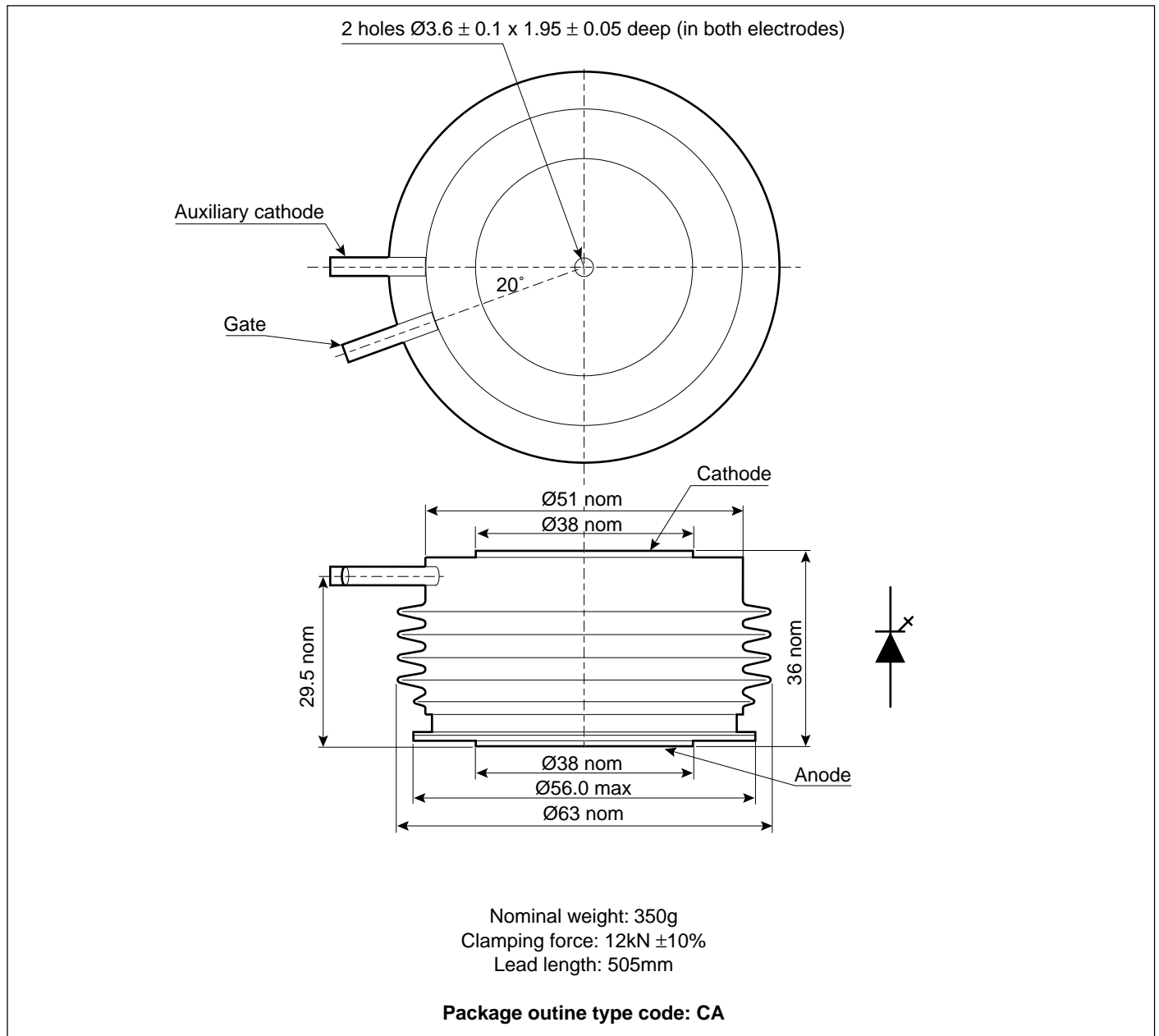

Fig.18 Maximum (limit) transient thermal impedance - double side cooled

DGT409BCA

PACKAGE DETAILS

For further package information, please contact the Customer Service Centre. All dimensions in mm, unless stated otherwise. DO NOT SCALE.



ASSOCIATED PUBLICATIONS

Title	Application Note
	Number
Calculating the junction temperature or power semiconductors	AN4506
GTO gate drive units	AN4571
Recommendations for clamping power semiconductors	AN4839
Use of V_{TO} , r_T on-state characteristic	AN5001
Improved gate drive for GTO series connections	AN5177

POWER ASSEMBLY CAPABILITY

The Power Assembly group was set up to provide a support service for those customers requiring more than the basic semiconductor, and has developed a flexible range of heatsink and clamping systems in line with advances in device voltages and current capability of our semiconductors.

We offer an extensive range of air and liquid cooled assemblies covering the full range of circuit designs in general use today. The Assembly group continues to offer high quality engineering support dedicated to designing new units to satisfy the growing needs of our customers.

Using the latest CAD methods our team of design and applications engineers aim to provide the Power Assembly Complete Solution (PACs).

DEVICE CLAMPS

Disc devices require the correct clamping force to ensure their safe operation. The PACS range includes a varied selection of pre-loaded clamps to suit all of our manufactured devices. Types available include cube clamps for single side cooling of 'T' 23mm and 'E' 30mm discs, and bar clamps right up to 83kN for our 'Z' 100mm thyristors and diodes.

Clamps are available for single or double side cooling, with high insulation versions for high voltage assemblies.

Please refer to our application note on device clamping, AN4839

HEATSINKS

The Power Assembly group has its own proprietary range of extruded aluminium heatsinks. They have been designed to optimise the performance of Dynex semiconductors. Data with respect to air natural, forced air and liquid cooling (with flow rates) is available on request.

For further information on device clamps, heatsinks and assemblies, please contact your nearest sales representative or Customer Services.



<http://www.dynexsemi.com>

e-mail: power_solutions@dynexsemi.com

HEADQUARTERS OPERATIONS

DYNEX SEMICONDUCTOR LTD

Doddington Road, Lincoln.

Lincolnshire. LN6 3LF. United Kingdom.

Tel: 00-44-(0)1522-500500

Fax: 00-44-(0)1522-500550

CUSTOMER SERVICES

Tel: +44 (0)1522 502753/502901. Fax: +44 (0)1522 500020

SALES OFFICES

North America Tel: (613) 723-7035. Fax: (613) 723-1518. Toll Free: 1.888.33.DYNEX (39639) /

Tel: (949) 733-3005. Fax: (949) 733-2986.

Rest Of World Tel: +44 (0)1522 502753/502901. Fax: +44 (0)1522 500020

These offices are supported by Representatives and Distributors in many countries world-wide.

© Dynex Semiconductor 2002 Publication No. DS4414-4 Issue No. 4.1 February 2002

TECHNICAL DOCUMENTATION – NOT FOR RESALE. PRODUCED IN UNITED KINGDOM

Datasheet Annotations:

Dynex Semiconductor annotate datasheets in the top right hand corner of the front page, to indicate product status. The annotations are as follows:-

Target Information: This is the most tentative form of information and represents a very preliminary specification. No actual design work on the product has been started.

Preliminary Information: The product is in design and development. The datasheet represents the product as it is understood but details may change.

Advance Information: The product design is complete and final characterisation for volume production is well in hand.

No Annotation: The product parameters are fixed and the product is available to datasheet specification.

This publication is issued to provide information only which (unless agreed by the Company in writing) may not be used, applied or reproduced for any purpose nor form part of any order or contract nor to be regarded as a representation relating to the products or services concerned. No warranty or guarantee express or implied is made regarding the capability, performance or suitability of any product or service. The Company reserves the right to alter without prior notice the specification, design or price of any product or service. Information concerning possible methods of use is provided as a guide only and does not constitute any guarantee that such methods of use will be satisfactory in a specific piece of equipment. It is the user's responsibility to fully determine the performance and suitability of any equipment using such information and to ensure that any publication or data used is up to date and has not been superseded. These products are not suitable for use in any medical products whose failure to perform may result in significant injury or death to the user. All products and materials are sold and services provided subject to the Company's conditions of sale, which are available on request.

All brand names and product names used in this publication are trademarks, registered trademarks or trade names of their respective owners.