



Instruction Manual For FINE OVEN

**Model DF411 DF611
DH411 DH611**

Version 4

- Thank you for purchasing the Yamato Scientific DF/DH fine oven.
- For correct use of this Fine oven, read this manual and the guarantee thoroughly before use. After reading them, keep the manual and the guarantee in a safe place for quick reference whenever required.



WARNING: Before using this product, carefully read and fully understand the instructions on safety . (WARNINGS and CAUTIONS) that appears elsewhere in this manual.

Be sure to follow the instructions and requirements on safety described in this manual when handling the product. Yamato Scientific Co., Ltd. assumes no liability for customer failure to comply with these instructions and requirements.

Yamato Scientific Co., LTD.

This paper has been printed on recycled paper.

EXPLANATIONS ABOUT SYMBOL MARKS	1
Symbol mark table	2
PERIL ARTICLES	4
BEFORE USING IT	5
To install and preparation before using	5
·Requirements for Installation	9
PRECAUTIONS IN HANDLING	10
SAFETY DEVICES AND ERROR CODES	14
Purposes and Operations of Safety Device and Counter-measures	14
DESCRIPTION AND FUNCTION OF EACH PART	15
Main unit	15
PREPARATION AND CHECK BEFORE USING	17
POWER ON/OFF	18
METHOD OF OPERATION MENU	19
Selection of operation mode	19
FIXED TEMPERATURE OPERATION INSTRUCTION	21
AUTO START OPERATION INSTRUCTION	23
AUTO STOP OPERATION METHOD	25
PROGRAMMED OPERATION METHOD	28
HANDLING METHOD OF PROGRAM MENU	31
To choose program menu function	31
TO MAKE OUT NEW PROGRAM	33
TO EDIT PROGRAM	34
TO EDIT SEGMENT	35
TO ADD SEGMENT	39
TO FINISH PROGRAM EDITING	40
TO DELETE PROGRAM	41
HANDLING METHOD OF FUNCTION MENU	42
To select function menu item	42
TO SET UP TIMER MODE	45
TO SET UP KEYLOCK MODE	46
TO SET UP BUZZER MODE	47
Calibration Offset Function	48
SETTING THE CALIBRATION OFFSET FUNCTION	50
TO CHECK ACCUMULATED OPERATION TIME	51
TO ADJUST TIME	52
TO MODULATE FAN BLADE(OPTION)	54
TO MODULATE DAMPER (OPTION)	55
SETTING THE COMMUNICATION LOCKOUT (OPTIONAL)	57
INDEPENDENT OVERHEAT PREVENTION	58
Setting the Temperature Range and Function	58
Activation/Setting Method	58
Precautions	58
MAINTENANCE AND INSPECTION	59
Daily check/care	59
LONG STORAGE AND DISPOSAL	59
AFTER SERVICE AND WARRANTY	60
MEASURE	61
SCHEMATICS	63
REPLACEMENT PARTS TABLE	67

NOTICE

This product and the instruction manual have several symbol marks to use safely. The accident might happen caused by incorrect interpret and using, classified shown in below.

Read this instruction manual after fully understand the meaning of the symbol marks.

 **WARNING** Accident might cause a person to die or seriously injured (※1).

 **CAUTION** Accident might cause a person to slightly injured (※2) or objective damages (※3) .

(※1) “Seriously injured” means injured by electrical shock, fracture of a bone, poisoning and the like with hospitalized or attend to hospital in long turn.

(※2) “Slightly injured” means injured by electrical shock, and the like not necessary to send to a hospital.

(※3) “Physically damages” means damages of property just like equipments, machines, structures and so on.

Denotes of symbol marks



This symbol mark shows “WARNING” (include “CAUTION”)subject. Concretely warning description is shown near to this symbol mark.



This symbol mark shows prohibit subject. Concretely prohibit description is shown near to this symbol mark.



This symbol mark shows the subject sure to do. Concretely description put into practice is shown near to this symbol mark.

Symbol mark table

Warning



Warning,
generally



Warning,
high voltage



Warning,
high temperature



Warning,
drive train



Warning,
explosive

Caution



Caution,
generally



Caution,
electrical shock



Caution,
scald



Caution,
no road heating



Caution,
not to drench



Caution,
water only



Caution,
deadly poison

Prohibit



Prohibit,
generally



Prohibit,
inflammable



Prohibit
to disassemble



Prohibit
to touch

Compulsion



Compulsion,
generally



Compulsion,
connect to the
grounding terminal



Compulsion,
install on a
flat surface



Compulsion,
disconnect the
power plug



Compulsion,
periodical
inspection

EXPLANATIONS ABOUT SYMBOL MARKS

WARNING

 Prohibit to use in the following locations, where a flammable or explosive gas is present.

**Never to use this product in the locations as a flammable or an explosive gas is present.
If not, It may cause a fire or an explosion, because this product is not expansion-proof.**

 Always connect the protective grounding wire to the ground.

Connect the ground-line correctly. This could cause a fire or an electrical shock due to leakage.

 Prohibit to use in unusual operation.

If the smoke or unusual smell come up, turn-off the power switch immediately and disconnect the power plug from the receptacle. This could cause a fire or an electrical shock.

 Do not use the power cord tie up in a bundle.

This could cause to a fire from over heat of the power cord.

 Do not injure the power cord.

Do not bend or twist or tug the power cord forcibly. This could cause a fire or an electrical shock.

 Do not use samples containing a flammable or explosive substance.

Never to use samples containing a flammable or explosive substance. This could cause a fire or an explosion.

 Do not disassemble and make modifications this product.

Do not disassemble and make modifications this product. This could cause a failure or a fire or an electrical shock.

 Do not touch the door during or immediately after operation

Do not touch the door during or immediately after operation. Severe burning injury may be caused due to the high temperature

CAUTION

 When thunder is coming.

When it thunders, turn off the power switch immediately. This could cause a failure or a fire or an electrical shock.

Explosive articles	Explosive	①Nitroglycol, Nitroglycerin, Nitrocellulose, and other explosive articles sort of nitric ester.
		②Trinitrobenzen, Trinitrotoluene, Picric acid, and other explosive articles sort of nitric compound.
		③Peracetic acid, Methyl-ethylketone peroxide, and other explosive articles sort of organic peroxide.
Combustible articles	Combustible	Metallic lithium, Metallic potassium, Metallic sodium, Yellow-phosphorus, Phosphorus sulfide, Red phosphorus, Sort of Celluloid, Calcium carbide, Lime phosphide, Magnesium powder, Aluminum powder, Other metallic powders except for magnesium and aluminum, Sodium dithionite(Hydrosulfite).
	Oxidizable	①Potassium chlorate, Sodium chlorate, Ammonium chlorate, and other articles sort of chlorate.
		②Potassium perchlorate, Sodium perchlorate, Ammonium perchlorate, and other articles sort of perchlorate.
		③Potassium peroxide, Sodium peroxide, Barium peroxide, and other articles sort of inorganic peroxide.
		④Potassium nitrate, Sodium nitrate, Ammonium nitrate, and other articles sort of nitrate.
		⑤Sodium chlorite, and other articles sort of chlorite.
		⑥Calcium hypochlorite, and other articles sort of hypochlorite.
	Flammable	①Ethyl-ether, Gasoline, Acetaldehyde, Propylene chloride, and other articles that have flammable temperature less than-30°C.
		②Normal hexane, Ethylene oxide, Acetone, Benzene, Methyl-ethylketone, and other articles that have flammable temperature less than0°C, over-30°C.
		③Methanol, Ethanol, Xylene, Pentyl acetate (Amyl acetate), and other articles that have flammable temperature less than30°C, over0°C.
		④Kerosene, Light oil, Turpentine oil, Isopentyl alcohol(Isoamyl alcohol), Acetic acid, and other articles that have flammable temperature less than 65°C, over 30°C.
	Inflammable gas	Hydrogen, Acetylene, Methan, Ethan, Propane, Butane, and other inflammable gaseous articles at 15 °C 1 atm.

(Extract from Japanese Government ordinance)

To install and preparation before using**WARNING****1. Always ground the unit**

- Connect the grounding cable to your ground conductor or ground terminal
- Do not forget to ground the Oven, to protect you and the unit from electrical shock in case of power surge
- Do not connect the grounding wire to a gas pipe, or by means of a lightning rod or telephone line. A fire or electrical shock will occur.

NOTE: The oven has not a plug connected because of the 220V specification

2. Choose a proper place for installation.

- Do not install the oven in a place where:
 - Flammable gas or corrosive gas is generated.
 - Ambient temperature exceeds 35°C
 - Ambient temperature fluctuates violently.
 - There is direct sunlight.
 - There is excessive humidity and dust.
 - There is a constant vibration.

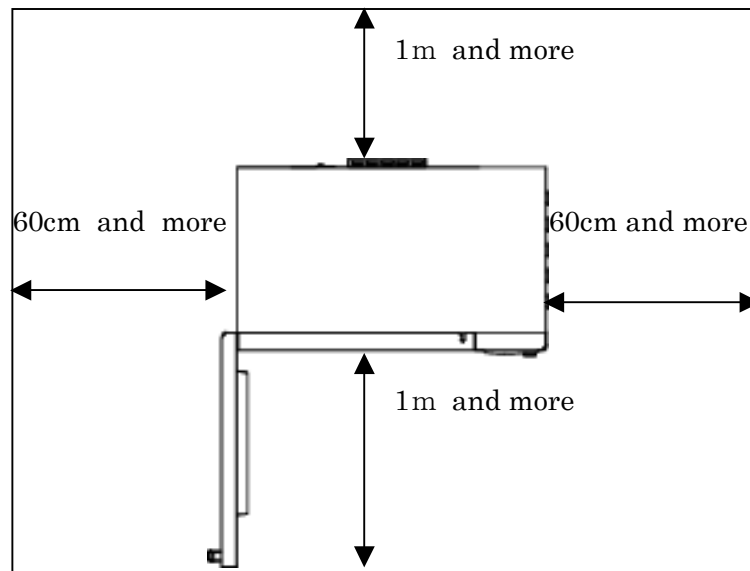

- Keep the following clearance around the oven.

**3. . Operation with ventilation**

When using this machine with ventilation (with Damper opened) it is required to make sure of full ventilation around the place. Without enough ventilation around the machine a hot flats from its exhaust opening will raise room temperature or the room can be filled with smoke and gas discharged from its materials. Therefore do not forget to connect an exhaust duct at its exhaust opening in order to discharge a blast wind outside. We can offer exhaust pipe flange and exhaust dust as an option by request.

BEFORE USING IT

REQUIREMENTS FOR INSTALLATION



WARNING

4. Choose a correct power distribution board.



- Choose a correct power distribution switchboard or receptacle that meets the oven's rated electric capacity.

Electric capacity :	Model DF411	AC200V	Single phase	11A
	Model DF611	AC200V	Single phase	16A
	Model DH411	AC200V	Single phase	14A
	Model DH611	AC200V	Single phase	20A

- Do not connect the oven to an outlet that differs from the above specifications because a fire or electrical shock will occur

5. Supply connections for the oven



- Request the supply connection for the 200V specifications from a licensed electrician.
- Failure to have this operation complete by certified personnel will cause a fire or electrical shock during Oven operations.

6. Do not use the unit in an area where there is flammable or explosive gas.



- Never use the unit in an area where there is flammable or explosive gas. The unit is not explosion-proof. An arc may be generated when the power switch is turned ON or OFF, and fire/explosion may result.



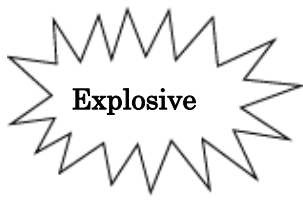

Flammable gas

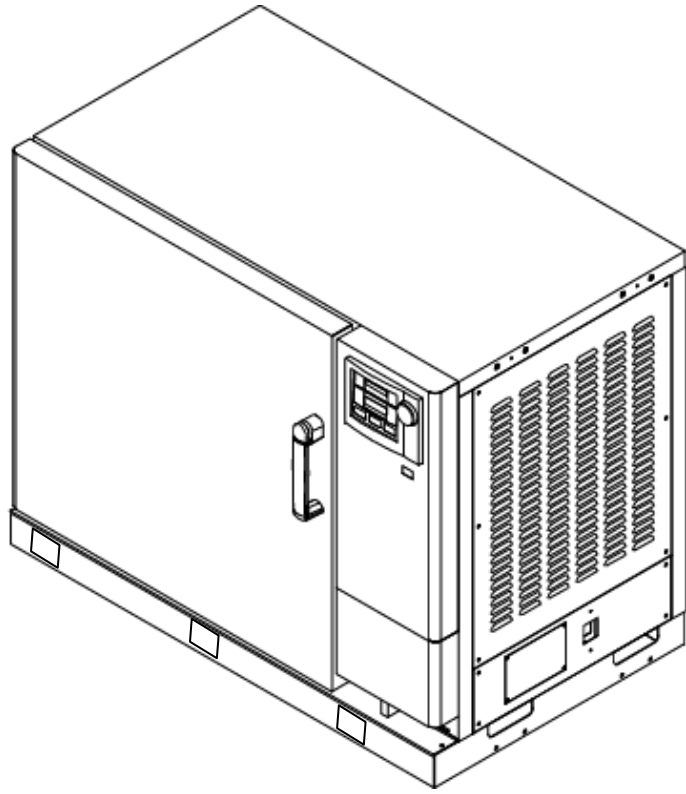

REQUIREMENTS FOR INSTALLATION**⚠ WARNING****7. Do NOT Make Modifications to the Product**

- Modification of the product is strictly prohibited. This could cause a failure

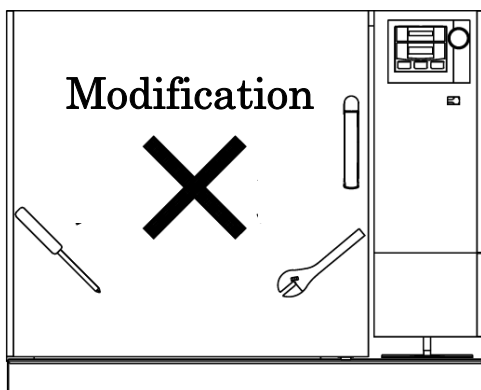
**8. Installation on Flat Surface**

- Install the product on a flat surface. Unanticipated problems or failures may occur otherwise.

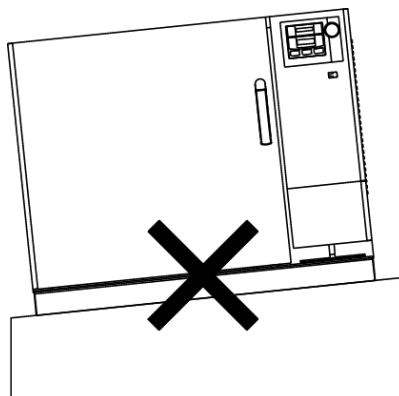
**CAUTION**

After installed, you should:



- It may cause injure to a person if this oven falls down or moves by the earthquake and the impact. etc..
- To prevent, take measures that the unit cannot fall down
- Secure the unit by putting the stoppers on the casters

·Requirements for Installation**CAUTION****Handling of power code.**

- Do not use the power cord if it is bundled or tangled. If it is used in this manner, it can overheat and fire may be caused.
- Do not process, bend, wring, or stretch the power cord forcibly. Fire or electrical shock may result.
- Do not put the power cord under the desk, chair, etc., or through an object. Fire or electrical shock may be caused.
- Do not run the power cord next to heating equipment such as a heater. The cover of the cord may melt and fire or electrical shock may result.



- When the power cord is damaged (exposure of the core wires, disconnection, etc.), turn off the power key right immediately, then turn off the circuit breaker and the main power. Contact customer service for a replacement immediately. If this procedure is not followed, fire or electrical shock may be caused.

Caution in setting shelves

- Do not use any shelves but the attached ones.
- If it is used in this manner, the oven cannot occasionally regulate temperatures properly.



- Put the attached shelves on the shelf brackets fitted to the chamber when you use the oven.



WARNING

Substances that Can be used



- Never use explosive substances (shown on page 34) , flammable substances (shown on page 34) and substances that include explosive or flammable ingredients in the unit
Explosion or fire may occur

Do not put the foreign substances in the oven



- Do not put a foreign substances such as metals or flammable substances in the opening of the unit (ventilation hole and exhaust port, etc.). If this procedure is not



- followed, fire, electrical shock or burn may result
- If the foreign substances enter the unit, turn off the circuit breaker immediately and contact a service technician for inspection. If this procedure s not followed, fire, electrical shock or burn may result

Caution in taking out a samples



- During and immediately after operation the internal surfaces of the chamber and the door are extremely "HOT". To prevent injury take out the samples when the chamber has cooled down or wear gloves while the chamber is still hot

When you open the door during working at the high temperature.



- Do not touch the internal surfaces of the chamber and the door when you will open the door, because they are extremely hot.



- To open the door while the chamber is still hot may cause the malfunction of a fire detector if it is installed near the oven.

Do not touch heated parts.



- Do not touch the door during or immediately after operation. Severe burning injury may be caused due to the high temperature

Do not climb on the oven



- Do not climb on top of the oven because it will fall down and break.
Failure to observe this caution may cause injury to a person

Do not put anything on the oven



- Do not put anything on top of the oven because they will fall and result in injury to a person.

CAUTION

Caution about the temperature range.

-  · Use the oven in the range of 40°C to 210°C

When you use the oven for the first time

-  · During the initial operation, the oven may occasionally generate an odor especially when high temperatures are reached. This odor is normal and does not signal a problem with the oven. The nature of the odor is caused by the adhesive on the insulation melting



About the temperature in the chamber

-  · Temperature display indicates the sensor temperature installed in the unit, however it does not always correspond to the temperature of the sample when the sample volume is very large or when the temperature is on the increase.

Caution about a drenched sample

-  · When using a very wet sample, try to drain it as much as possible before putting it in chamber.

Caution about powdery sample and the loading of samples

-  · There are times when a powder sample is scattered by the sudden decompression operation or purge operation. When performing decompression or purge, open the valve very slowly.
-  · It occasionally takes a long time before the chamber reaches the target temperature if the chamber is congested with samples with the large specific heat is in it.
In such cases, reduce samples. Moreover, note that the temperature display occasionally unsettles when you process an exothermic sample.

Distribute samples

-  · Each shelf can carry a uniform load of 15 kg (33 lb.). When you place samples on a shelf, distribute them evenly over the shelf area.
· If a shelf is congested with samples, the oven occasionally cannot regulate temperatures properly. To ensure the oven's temperature accuracy, there should be open space of at least 30% on each shelf.

CAUTION

Never use corrosive samples

-  · Most parts are made of stainless steel(SUS304). However, strong acid occasionally corrodes even stainless steel. Besides this,
- The silicone rubber packing is also vulnerable to acid, alkali, oil and halogen's solvent

Install the Oven on a level area

-  · Do not installation the oven on a non level surface. This will cause hazards to the operator and create problems during actual operation.



CAUTION

Do not place any samples on the bottom of the chamber



• Do not place any samples on the bottom of the chamber to heat, because it affects the temperature control of the oven.

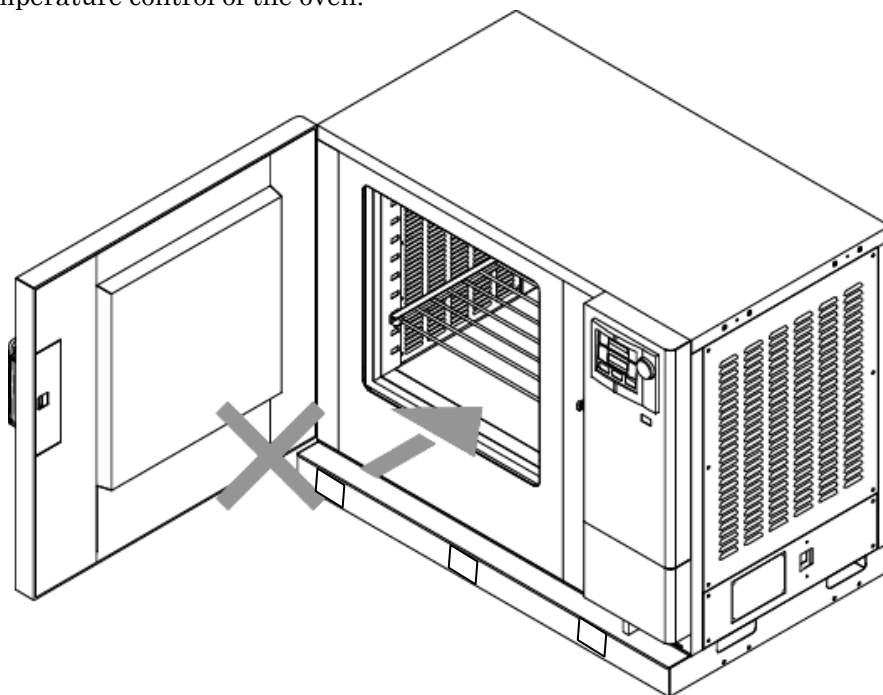

• Always put the samples on the attached shelves. Place sample so that it does not touch the interior wall of the chamber

• Set the shelves on the shelf brackets that will accommodate the size of the sample

During a thunder storm



• During a thunder storm, turn off the power key immediately, then turn off the circuit breaker and main power. If this procedure is not followed, fire or electrical shock may be caused

when having a blackout



• Once the power supply is recovered, the oven can resume when it stopped because of having a blackout

When you open and shut the door



• Do not put your hand either face near the door when you open and shut the door. Failure to observe this caution may result in injury because the door hits your hand or face.

SAFETY DEVICES AND ERROR CODES

Purposes and Operations of Safety Device and Counter-measures

When an abnormal condition occurs, an error code is displayed in the main display. Immediate action should be taken according to the specific counter-measures.

Er.No	Error name	Main Display	Sub display
Er.00	Communication Er	Er.00	Communication Er Ex a connection
Er.01	Sensor Error	Er.01	Sensor Error Calls a service
Er.02	SSR Error	Er.02	SSR Error Calls a service
Er.03	Heat Error	Er.03	Heat Error Calls a service
Er.04	Fan Error	Er.04	Fan Error Calls a service
Er.05	Auto-damper Er	Er.05	Auto-damper Er Calls a service
Er.07	Overheat Error	Er.07	Overheat Error Calls a service
Er.08	Controller Er	Er.08	Controller Er Calls a service
Er.10	Main relay Er	Er.10	Main relay Er Calls a service
Er.14	RAM Error	Er.14	Controller Er Calls a service
Er.15	EEPROM Error	Er.15	Controller Er Calls a service

How to manage

- In case these error code mentioned above is displayed, recode the error code and shut off the power immediately
- In case “ Er14” is displayed, once turn off a circuit breaker. Then, after more than 30seconds, turn on the breaker again. In case “Er14”is still displayed even after the breaker is turned on, then contact a customer support center
- In case anyabnormal condition occurs, parts replacement or device inspection should be taken. Contact a customer support center. In contacting, never fail to inform of error number. Refer to P 60(AFTER SERVICE AND WARRANTY)

DESCRIPTION AND FUNCTION OF EACH PART

Main unit

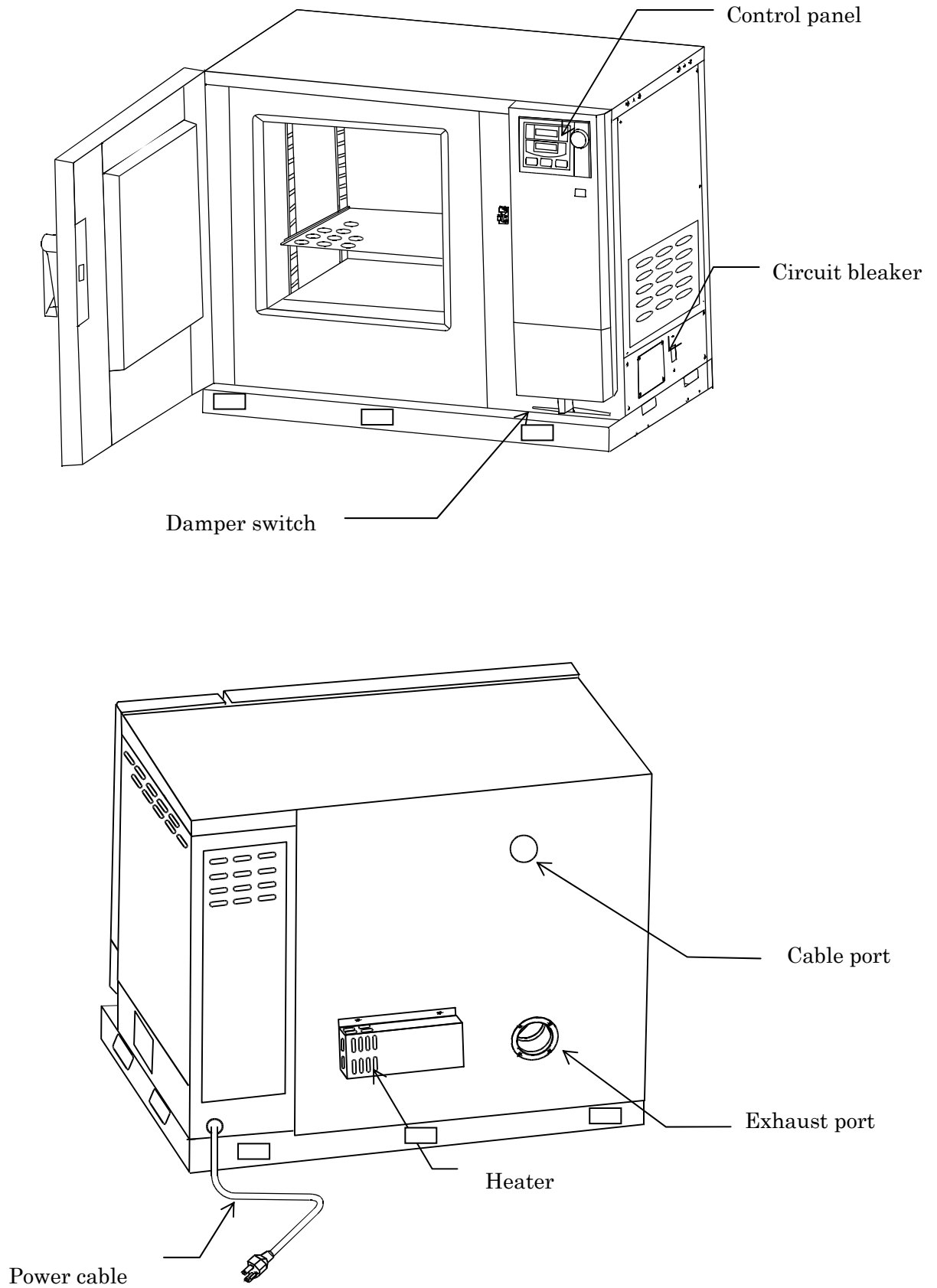

Control Panel

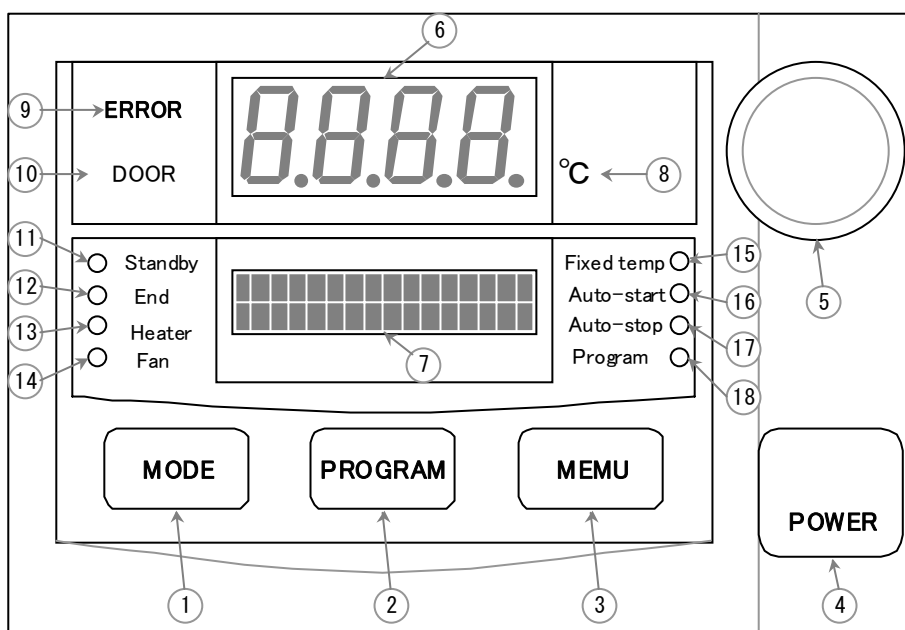

1	MODE key	Key to select a function from program input, edit,delete modes,hour/time setting, change-over mode, and other functions.
2	PROGRAM key	Starting/Closing of program menus
3	MENU key	Key to select the operation mode. Each mode of fixed temprature, auto-start,auto-stop and program operation can be selected.
4	POWER key	Key to change over the controller from the standby mode to the operation mode or from the operation mode to the standby mode.
5	Jog Dial	Key to select menu items, compile parameters etc.
6	Main Display	It displays temperatyre measurements,set values (temperature, time, hour, etc.), program information, error information, etc.
7	Sub Display	It displays set temperture, remaining time, current hour and execution segment No. etc.
8	°C lamp	It flashes when displaying temperature of the inside of tank at main display
9	ERROR lamp	It flashes when any trpuble within equiment
10	DOOR lamp	It flashes to indicate that door is being opened
11	STANDBY lamp	It flashes to indicate that the instrument is in the preoperational standby mode.
12	END lamp	Stays lit in the end of operation
13	HEAT lamp	Stays lit or blinks when heater is on
14	FAN lamp	It flashes when fan is charged with electricity.
15	FIXED-TEMP	It flashes while it is operated at fixed temperature.It blinks when operation mode is selected.
16	AUTO-START	It flashes to indicate that auto start is carried out. It blinks when operation mode is selected.
17	AUTO-STOP	It flashes to indicate that auto stop is carried out. It blinks when operation mode is selected.
18	PROGRAM lamp	It flashes to indicate that program operation is carried out. It blinks when operation mode is selected.

PREPARATION AND CHECK BEFORE USING



Warning

Never fail to connect earth (green core wire of power supply code) with your grounding wire or grounding terminal part in order to avoid electric shock.

- Don't connect earth to gas pipe or water main
- Don't use forked plug receptacle since it can cause heat generation etc.
- Don't install it at place where inflammable gas or corrosive gas breaks out.



Caution

Plug receptacle check

- Connect power supply code to proper switch board or plug receptacle

Safety check

- Make sure that independent overheat prevention is set 15°C higher than the temperature of its inside to be used.

Charge check

- In order to charge battery for date back-up, in case of new installment or circuit breaker is off for many hours, turn on the breaker and keep the equipment with electricity on and have it for more than 25 hours

Turn on of circuit breaker.

- When power supply is off, present date and time are shown on sub display
 ※Clock is not set correctly when it is forwarded from factory. Refer to page51 for handling and adjust date and time accordingly

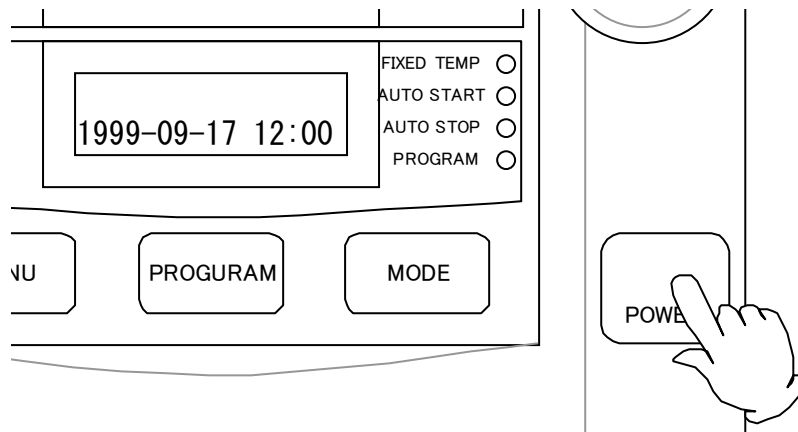
Push the power key

- After short sound of beep, power supply is turned on.

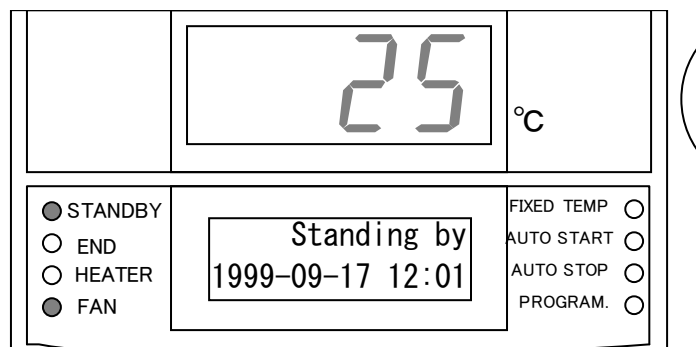

- After power supply is turned on, fan starts to spin and “fan lamp” flashes. Main display indicates temperature of the inside of tank and “°C lamp” flashes. Sub display indicates “standing by” and “standing by lamp” flashes. This is “On standby” state.
- A power supply breaks off with when a key is pushed again.
- When you press “Power supply key” again, the power will be turned off. In case of first use, power supply of the equipment is still off. If you turn off short circuit breaker while using or main power supply is shut out because of power failure, it will be restored to the condition which main power supply is yet to be shut out. This is “Instantaneous suspension recovery function”.

METHOD OF OPERATION MENU

Four kinds of “Operation modes” as follows

No.	Operation mode	Function
1	FIXED-TEMP	It is a operation method to bring the oven to the desired temperature and keep it steady.
2	AUTO-START	It is a operation method to stop a fixed temperature operation when reached the set time or hours.
3	AUTO-STOP	It is a operation method to start the fixed temperature operation when reached the set time or hours.
4	PROGRAM	It is a operation method that can start or stop a operation either when reached the set time or hours. Moreover, it can change the temperature when reached time and repeat to do that.

Selection of operation mode

- Confirm that a power supply is on

1. Push the MENU key

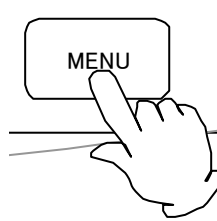

- Operation menu start and becomes an Operation mode Choice screen.

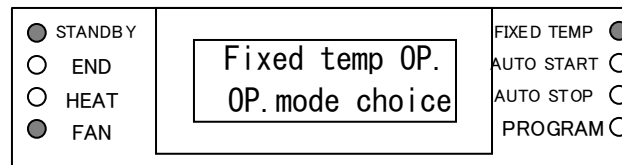

- On operation mode choice screen, you can see blinking display at sub display which indicates the name of operation mode currently selected, and operation lamp blinks correspondingly.
 - ※ When the equipment is used for the first time, fixed temperature operation mode is already selected. Other than that case, the operation mode that is carried out in the last use will be selected.

No.	Operation mode	Indicate lamp	Sub display
1	Fixed temp OP.	Fixed temp Lamp	Fixed temp OP. OP. mode choice
2	Auto-start OP.	Auto start Lamp	Auto-start OP. OP. mode choice
3	Auto-stop OP.	Auto stop Lamp	Auto-stop OP. OP. mode choice
4	Program OP.	Program OP. Lamp	Program OP. OP. mode choice

2. Turn the jogdial

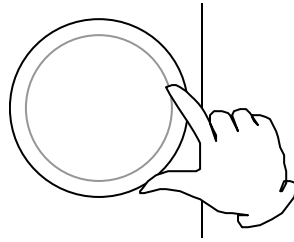

- Use the jogdial to change the displayed setting to the operation mode

3. Press the jogdial

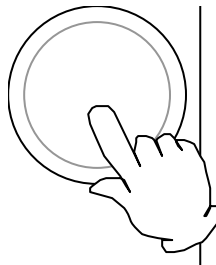

- Operation mode was decided. Input screen of each operation mode

4. Method of Cancellation

- Press “Operation menu key” again if you want to cancel the operation menu halfway

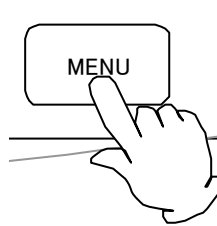

FIXED TEMPERATURE OPERATION INSTRUCTION

1. Chose the “Operation at the constant”

- It is made to indicate “Fixed temp OP.” at operation mode choice screen, and push the jog dial

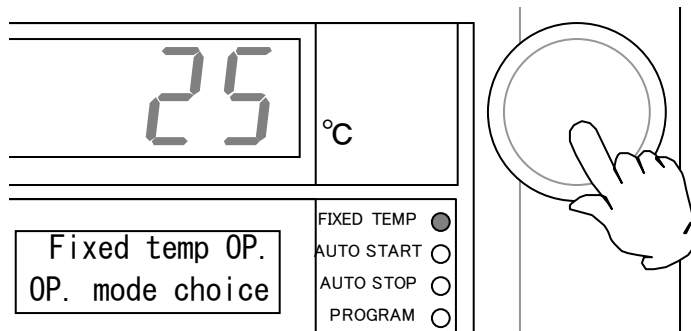

2. Set up temperature

- Next it moves to input screen of setup temperature, sub display indicates “Setup Temp” and the number which indicates the temperature blinks.

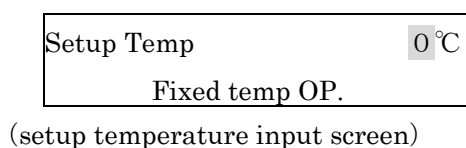

- Turn the jog dial and setup temperature should be indicated.

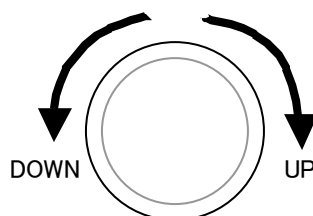

3. Push the jog dial

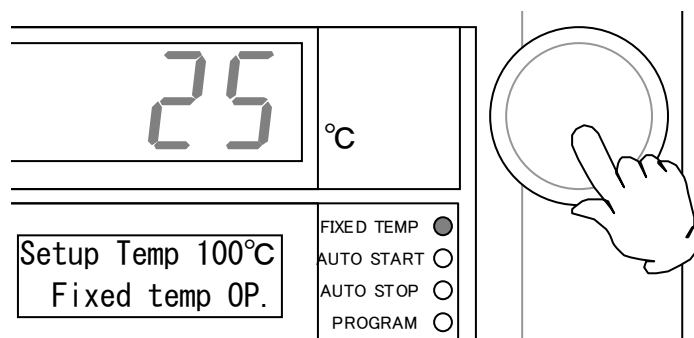

- Set up temperature is decision. And to start the fixed temperature operation

- When fixed temperature operation starts, heater will work on and off according to setup temperature. When heater is on, “Heater” lamp flashes. “Fix temp” lamp will change from blink to flash.

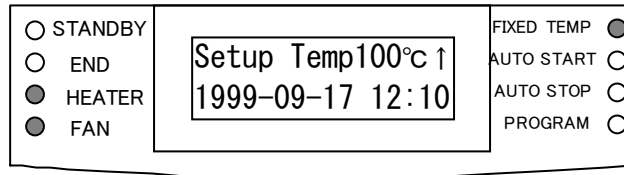

- During fixed temperature operation, sub display indicates temperature and you can see blinking display of arrow sign, which indicates the condition of temperature control. The direction of arrow sign will be as follows according to the relationship between setup temperature when fixed temperature operation starts and temperature of the inside of chamber.

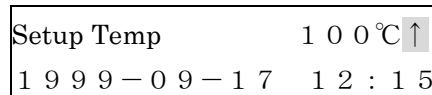

(When setup temperature is higher than that of the inside of chamber)

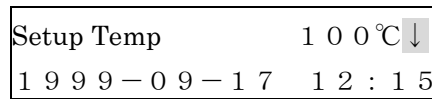

(When setup temperature is lower than that of the inside of chamber)

- The direction of arrow sign will be as follows when temperature of the inside of chamber becomes higher or lower by 2.5°C that setup temperature.

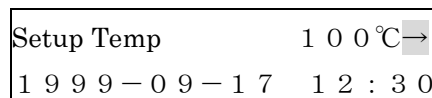

(When temperature of the inside of chamber reaches setup temperature)

4. How to “Stop”

- Operation stopped at press “POWER” key

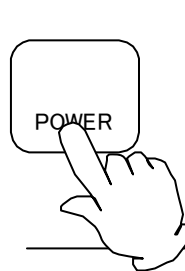

AUTO START OPERATION INSTRUCTION

1. Choose “Auto Start Mode”

- Indicate “Auto start” at operation mode and press jog dial.

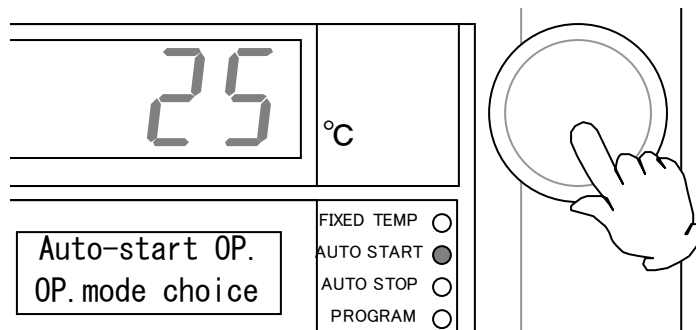

2. Input and decision to “setup temperature”

- Input setup temperature by jog dial and fix it

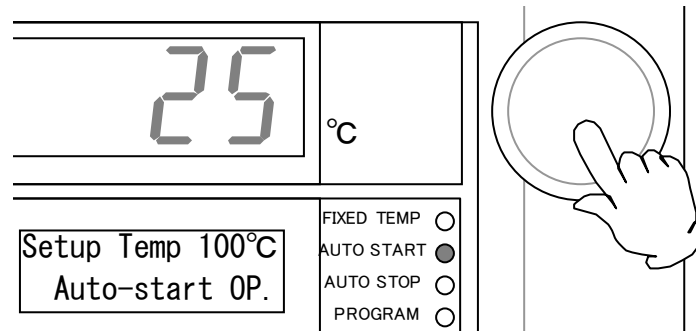

3. Input “Wait Time to operate / Start time”

- After setup temperature is decided, input screen for wait time to operate or start time appears. When timer mode setup indicates “Timer”, you can input wait time to operate and when “The hour” is indicated, you can input start time to operate
※ When it is forwarded from factory, “Time” is selected. Concerning timer mode, refer to page45.

Wait Time	3 0 m i n
Auto-start OP.	

(Input screen for wait time)

Start Time	0 : 0 0
Auto-start OP.	

(Input screen for start time)

- Turn the jog dial indicate to hoping hour or time.

4. Press "Jog dial"

- After wait time/start time is decided, it will go into wait time for auto start mode operation. "Auto start lamp" will change from blink to flash and "Standby lamp" will blink. Sub display indicates setup temperature and remaining time for startup.

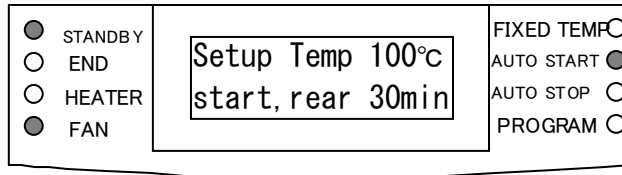

- When remaining time becomes 0, operation begins. when operation begins, "Standby Lamp" goes out and sub display indicates the same display as is shown in fixed temperature operation.

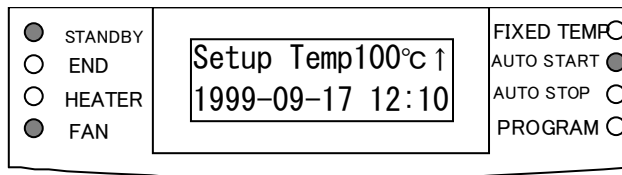

5. How to "Stop"

- If you want to suspend the state of operation waiting or stop operation halfway, press "Power Key"

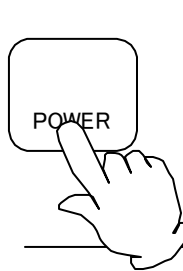

1. Choose “Auto stop”

- Have “Auto stop” display on operation mode choice screen and press jog dial.

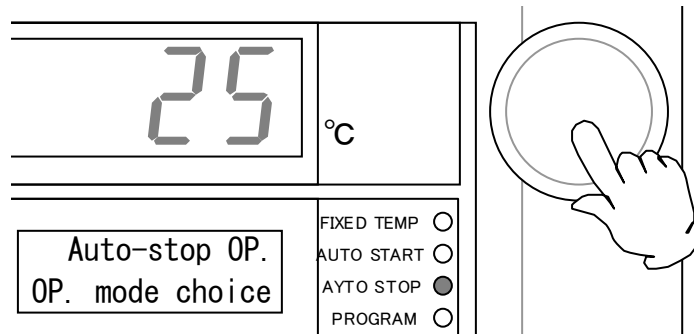

2. Input “Setup temperature” and fix it

- Input setup temperature by jog dial and fix it

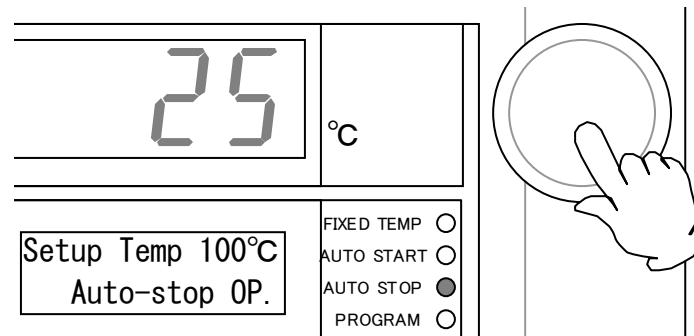

3. Input and fix operation time / operation stop hour

- When setup temperature is fixed, input screen for operation time or Auto stop operation appears. If timer mode setup indicates “Time”, it is to input operation time. If it indicates “Hour”, it is to input the hour to stop operation.

stop Time	3 0 m i n
Auto-stop OP.	

(Edit screen for operation time)

stop. Time	0 : 0 0
Auto-stop OP.	

(Edit screen for operation stop hour)

- Turn jog dial to have designated time or hour display and press the jogdial.

4. To choose and fix “Wait function”.

- Choice screen for wait function is displayed only when it is set as “Time” of timer mode. It is not displayed when it is to set as “Hour” of timer mode, so proceed to the next stage “Choice of fan”.
- Turn jog dial to choose either “On” or “Off” and press the jog dial to fix it.

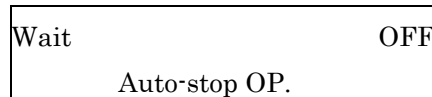

(Wait function choice screen)

5. Choose “Fan”.

- Turn jog dial to choose either “On” or “Off” and press the jog dial to fix it.

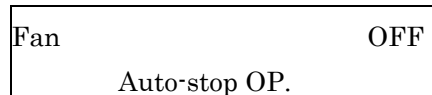

(Fan choice screen)

6. Press Jog dial.

- Fan function is fixed and auto stop mode operation starts. “Auto stop lamp” will change from blink to flash and sub display indicates temperature and remaining time toward operation stoppage.

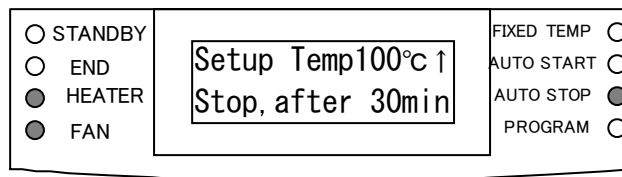

- While wait function is “On”, when temperature of the inside of chamber is lower by 3°C or more, or higher by 6°C or more than setup temperature, timer countdown will be suspended for a while and sub display indicates blinking sign of “Waiting”.

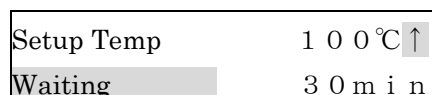

(Indication in wait)

- When remaining time is up, operation stops. When operation stops, “End lamp” blinks and sub display indicates operation stop time.

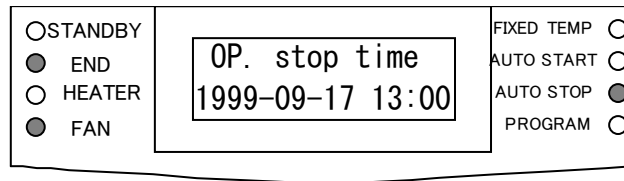

- When you choose “Off” on fan function, fan will stop at the same time that operation stops.

7. How to stop

- Press “Power Key” if you want to suspend operation.

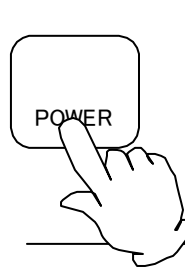

PROGRAMMED OPERATION METHOD

- To carry out program operation, register program at the beginning through program menu.

1. To choose “Program operation mode”

- To have “Program operation” display on operation mode choice screen and press jogdial.

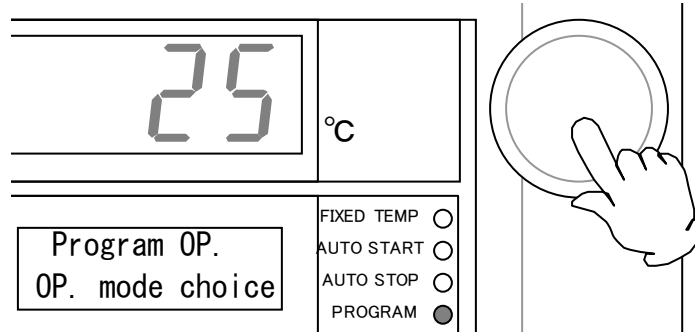

2. To Choose “Program number” and Fix it.

- Choose program number by jog dial and fix it.

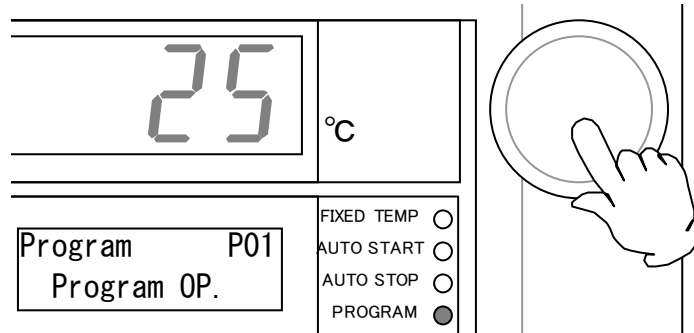

- In case no program is registered, after beep sound of buzzer and sub display indicates message. In that case register the program again and do it over from the beginning on “Program menu”.

A program isn't
Registered

(Indication in no program)

3. To edit operation wait time / hour

- When program number is fixed, edit screen for wait time or start time appears. When timer mode setup indicates “Time”, it is to edit wait time to operate and when “Hour” is indicated, it is to edit start time to operate.

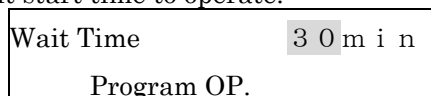

(Edit screen for wait time to operation)



(Edit screen for start time for operation)

- Turn jog dial and have designated time or hour display.

4. To press jog dial

- Wait time / Start time will be fixed and it will go into operation standby of program operation mode. While operation is in the state of waiting, “Program lamp” changes from blink to flash and “Standby lamp” blinks. Sub display indicates program number and remaining time toward operation startup.

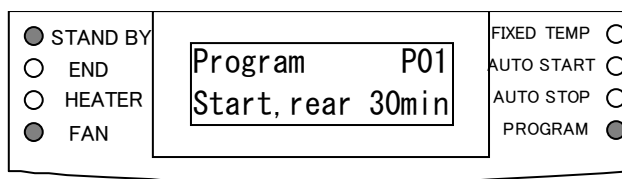

- When remaining time becomes 0, program operation begins. When operation begins, “Standby Lamp” goes out and sub display indicates segment number which is being carried out and setup temperature.

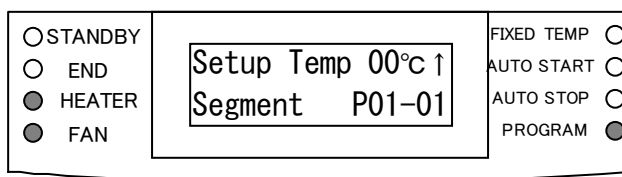

- While lamp is turned on, segment number and remaining time of lamp time are displayed alternately.



(Segment number during the practice)

↓



(The rest time of the lamp time)

- During Soak operation, segment number and rest time of Soak time are displayed alternately. However in case of waiting the blinking message “Waiting” is shown.

Setup Temp	1 0 0 °C ↑
Segment	P 0 1 - 0 1

(Segment number during the practice)



Setup Temp	1 0 0 °C ↑
Soak , after	3 0 m i n

(The rest time of the Soak time)

Setup Temp	1 0 0 °C ↑
Waiting	1 m i n

(A case during the wait)

- While segment of repeat section is being carried out, segment number and the rest number of repeat times are displayed alternately.

Setup Temp	1 0 0 °C ↑
Rep. rest	1 0

(The rest number of times of the repeat)

- When program operation ends, “End lamp” blinks and sub display indicates the time when the operation ends.

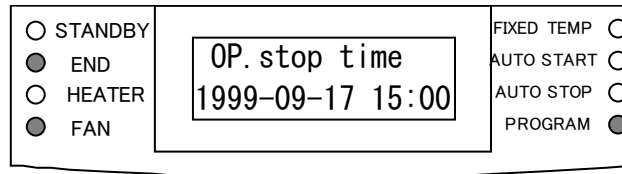

- When you choose “Off” in setting fan-spinning speed of program segment, fan will stop at the same time that operation ends.

5. How to stop

- If you want to suspend the state of operation standby or stop program operation halfway, press “Power key”.

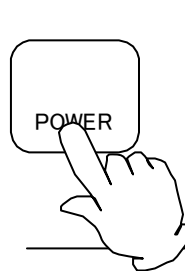

HANDLING METHOD OF PROGRAM MENU

Program menus are three kinds.

No.	Function name	Contents
1	New program making	Function to make new program and register
2	Program editing	Function to edit and check registered program
3	Program deletion	Function to delete registered program

To choose program menu function

- Make sure that power is on.

1. Press “Program Key”

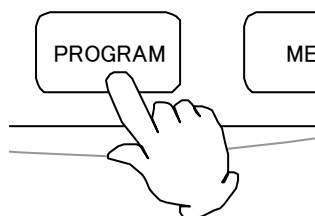

- Program menu starts up and function choice screen appears.

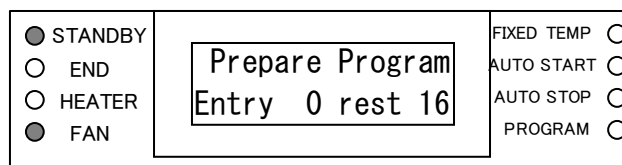

- Sub display indicates the number of registered program and the number of remaining segment and also blinking display of function name which is being chosen.

No.	Function name	Sub display
1	Prepare Program	Prepare Program Entry 0 rest 1 6
2	Edit Program	Edit Program Entry 0 rest 1 6
3	Delete Program	Delete Program Entry 0 rest 1 6

2. Turn “Jog dial”

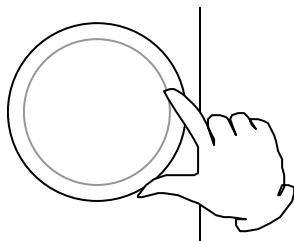

- Function name is replaced by turns.

3. Press “Jog dial”

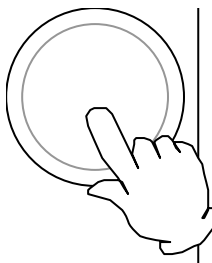

- Kind of function is fixed and input screen of each function appears.

4. How to cancel

- If you want to cancel program menu halfway, press “Program Key” again.



TO MAKE OUT NEW PROGRAM

- First of all, make sure that the number of remaining segment is not 0. In case the number is 0, delete either registered program before making new one.

1. To choose “Prepare program”

- On function choice screen in program menu, have “Prepare program” display and press jog dial.

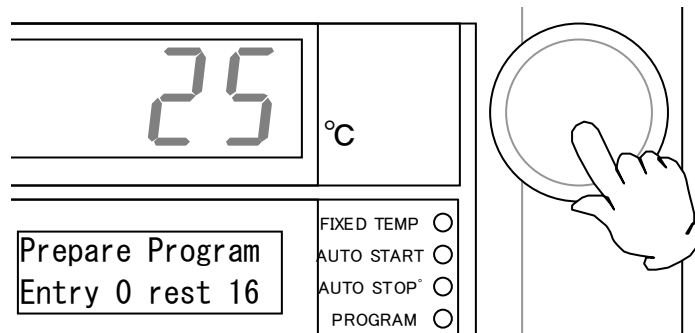

2. To choose “Program number”

- Program number choice screen appears, sub display indicates “Prepare” and the number which indicates program number blinks. Turn jog dial to have the program number which you need display from “P01~P99”.
- * However program number, which is already registered is not displayed.

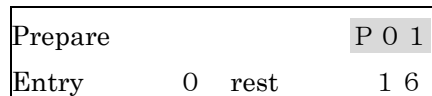

(Program number choice screen)

3. Press “Jog dial”

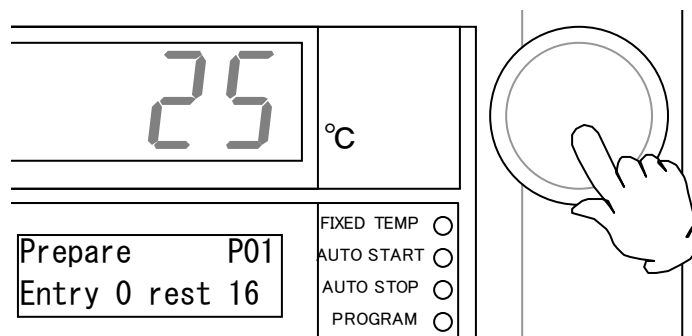

- This fixes program number. When program number is decided, “Edit program” screen appears, so that you proceed to page35.

TO EDIT PROGRAM

- First of all, make sure that program is already registered.

1. To choose “Edit program”

- On function choice screen in program menu, have “Edit program” display and press jog dial.

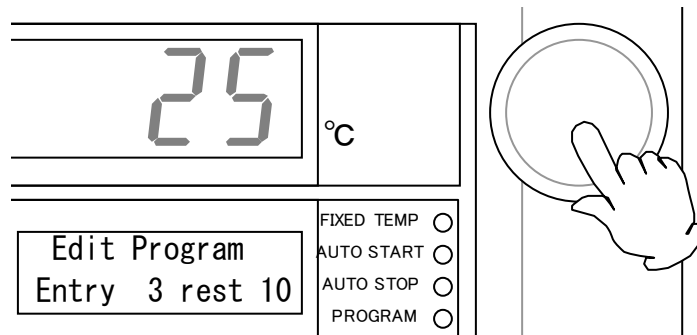

2. To choose “program number”

- Program number choice screen appears and sub display indicates “Editing” and the number which indicates program number blinks. Turn jog dial and have program number which you want to edit display among registered program. Sub display indicates the number of segment which chosen program uses and also the number of remaining segment on lower berth.

Editing	P 0 1
Use 5	rest 1 0

(Program number choice screen)

3. Press “Jog dial”

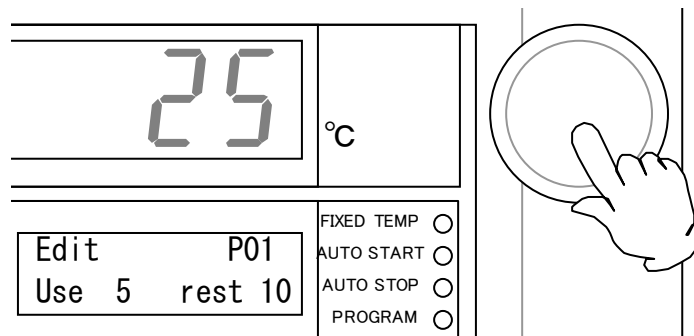

- This fixes program number. When program number is fixed, “Edit Segment” screen appears, so that proceed to page 35.

- There are 12 kinds of setup items of 1 segment. (Full option installation)

No.	Name	Setup range	Option
1	Ramp time	step, 1mi~999hr, end	
2	Setup temp	A setup temperature range by the model	
3	Soak time	0mi~999hr, Hold	
4	Wait mode	OFF, ON	
5	Fan	OFF, 1~10 (or ON) ※	○
6	Damper	0%, 25%, 50%, 75%, 100%	○
7	Event 1	OFF, ON	○
8	Event 2	OFF, ON	○
9	Event 3	OFF, ON	○
10	Event 4	OFF, ON	○
11	Rep. start segment	No. Segment number that 1 - 5 have been registered	
12	Rep count	1~9999, Infinity	

※ In case “Wind velocity variable device” option is not equipped, you can choose “On” or “Off” of fan only by “End segment”

- Concept of segment is shown as below. However “Start temp” corresponds to “Temperature of the inside of chamber” when you carry out segment number 1 just after program starts. Other than that case it will be “Setup temp” of segment, which is carried out most recently.

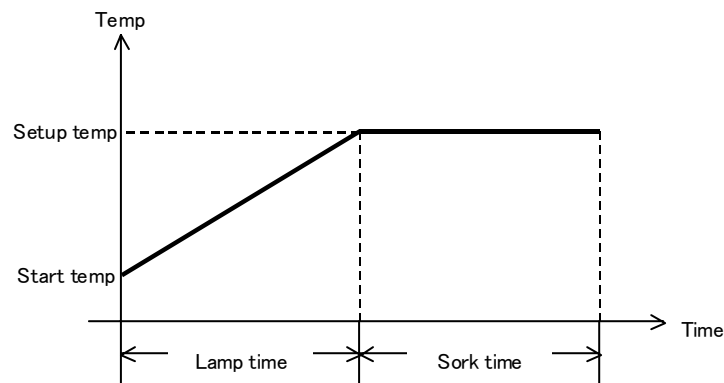

- Concept of repeat is shown as below. The number of repeat times does not include the first practice of repeat section.

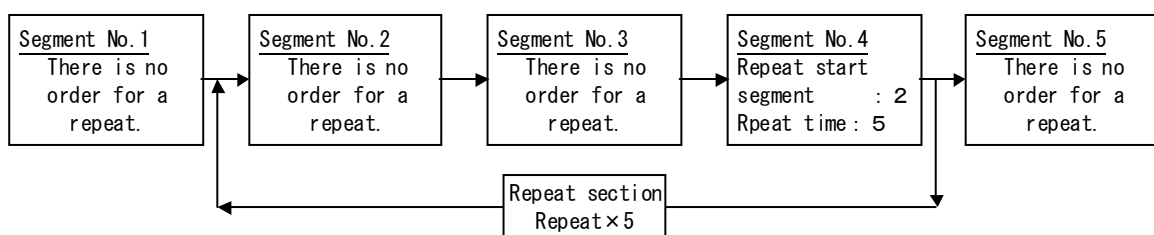

1. To choose “Setup item”

- When program number is fixed by “Prepare program” or “Edit program”, setup item choice screen appears. Sub display indicates the name of item. Turn jog dial to choose one.

No.	NAME	Sub display
1	Ramp time	Ramp time ▶ 3 0 m i n P 0 1 - 0 1 rest 1 0
2	Setup temp	Setup temp ▶ 1 0 0 °C P 0 1 - 0 1 rest 1 0
3	Soak time	Soak time ▶ 3 0 m i n P 0 1 - 0 1 rest 1 0
4	Wait mode	Wait ▶ OFF P 0 1 - 0 1 rest 1 0
5	Fan	Fan ▶ 1 0 P 0 1 - 0 1 rest 1 0
6	Damper	Damper ▶ 0 % P 0 1 - 0 1 rest 1 0
7	Event 1	Event 1 ▶ OFF P 0 1 - 0 1 rest 1 0
8	Event 2	Event 2 ▶ OFF P 0 1 - 0 1 rest 1 0
9	Event 3	Event 3 ▶ OFF P 0 1 - 0 1 rest 1 0
10	Event 4	Event 4 ▶ OFF P 0 1 - 0 1 rest 1 0
11	Rep. Start segment	Rep. start ▶ S 0 1 P 0 1 - 0 1 rest 1 0
12	Rep count	Rep. count ▶ 9 9 9 9 P 0 1 - 0 1 rest 1 0
13	Append seg	Append seg. P 0 1 - 0 1 rest 1 0
14	Program End	Program End P 0 1 - 0 1 rest 1 0

- ※ Sub display indicates program number and segment numbers which are being edited and also the number of remaining segment. If you turn jog dial, contents of all registered segment will be displayed. However items of “Append seg” and “Program End” are displayed after contents of final segment is displayed.
- Among setup items, some don’t make any sense or of no effect according to conditions. Those will not be displayed as the setup item (in the cases mentioned below.)

Item name	Case of not displayed
Ramp time	It is constantly displayed.
Setup temp	It is not displayed when ramp time indicates “End”.
Soak time	It is not displayed when ramp time indicates “End”.
Wait mode	It is not displayed when ramp time indicates “End” and Soak time shows “Hold”.
Fan	When “Wind velocity variable device” option is equipped it is constantly displayed. In case the option is not equipped it is displayed only when ramp time indicates “End”.
Damper	While “Auto damper” option is equipped, it is constantly displayed. In case it is not equipped, it is not displayed.
Event1~4	While “Event output” option corresponding to event function 1~4 is equipped, it is constantly displayed. When the option is not equipped, it is not displayed.
Rep. start segment	While ramp time indicates “End” and Soak time indicates “Hold”, it is not displayed. It is not displayed also when it is inserted between repeat sections designated by other segment.
Rep count	It is not displayed when repeat start segment is not displayed and “Nothing”.
Append seg	It is not displayed when ramp time indicates “End” and Soak time indicates “Hold”.

※ It is impossible to change contents of program when it is in operation. In that case cursor is not displayed on setup item choice screen. You can only check the contents

2. Press “Jog dial”

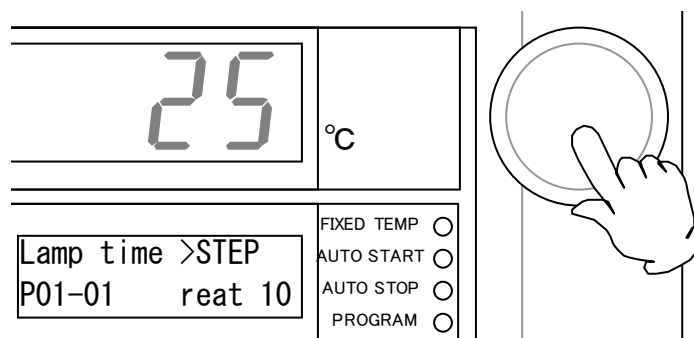

- If you choose setup time and press jog dial, Step Edit screen appears. Blinking cursor disappears and Step starts to blink.

Ramp time	>STEP
P 0 1 - 0 1	rest 1 0

(Choice screen)



Ramp time	STEP
P 0 1 - 0 1	rest 1 0

(Edit screen)

3. Input Step and fix

- Turn jog dial to have setup contents display and press jog dial.

After Step is fixed, you go back to setup item choice screen.

Ramp time	1 2 h 3 4 m
P 0 1 - 0 1	rest 1 0

(Fix input content)



Ramp time	▶ 1 2 h 3 4 m
P 0 1 - 0 1	rest 1 0

(Choice screen)

4. How to cancel

- If you want to cancel the input of Step halfway, press “Program Key”. Contents which is being input are cancelled and you go back to setup item choice screen.

Ramp time	1 2 h 3 4 m
P 0 1 - 0 1	rest 1 0

(Cancel input content)



Ramp time	▶ STEP
P 0 1 - 0 1	rest 1 0

(Choice screen)

1. To choose “Append seg”

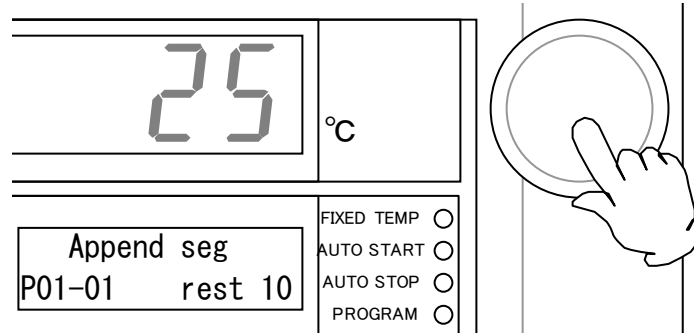

- On setup item choice screen, have “Append seg” display and press jog dial.

※ “Append seg” is not displayed when ramp time of last segment number indicates “End”, sort time indicates “Hold” and the number of repeat times is “limitless”. It is not displayed when key lock mode is “on” and program which is being edited is in operation.

- Segment number increases by one, while remaining segment number decreases by one. Then you go back to setup item choice screen and ramp time of appended segment number is displayed.

Append seg
P 0 1 – 0 1 rest 1 0

(Add segment)



Ramp time ►STEP
P 0 1 – 0 2 rest 9

(Choice screen)

- Contents which are initially set up with appended segment are as follows. Segment which is carried out at the stage of program preparation has the same contents.

Item name		
Ramp time	Step	
Setup temp	0°C	
Soak time	Hold	
Wait function	Off	Wait function is of no effect since Soak time indicates “Hold”.
Fan spinning	10	It is effective only when option is installed.
Damper opening	0%	It is effective only when option is installed
Event1~4	Off	It is effective only when option is installed
Repeat start segment	No	Repeat start segment is of no effect since Soak time indicates “Hold”.

The number of repeat times	Infinity	The number of repeat times is of no effect since repeat start segment is of no effect.
----------------------------	----------	----------------------------------------------------------------------------------------

TO FINISH PROGRAM EDITING

1. To choose “Program End”

- On setup item choic screen have “Program End” display and press jog dial.

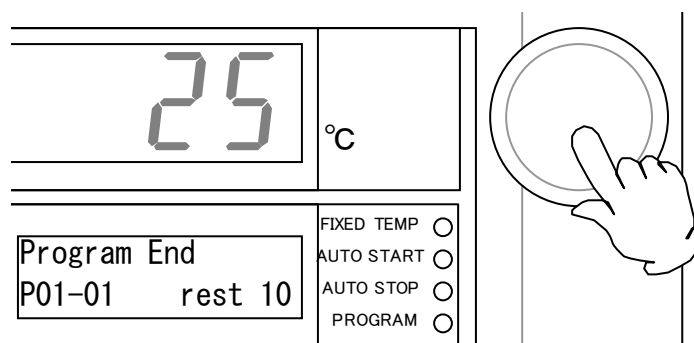

- ※ You can end by pressing “Program Key” on setup item choice screen, too.

TO DELETE PROGRAM

- First of all, make sure that program is registered.
- ※ You can not delete program which is in operation.

1. To choose “Delete program”

- On function choice screen in program menu, have “Delete program” display and press jog dial.

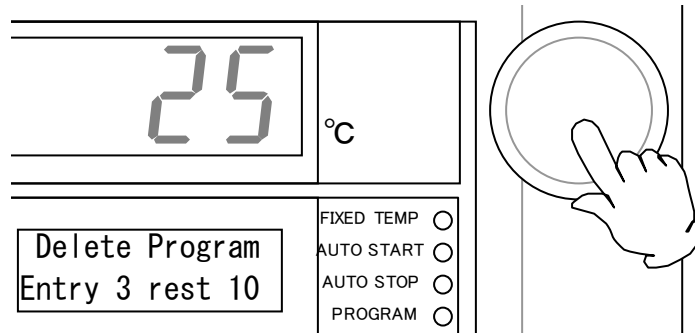

2. To choose “Program number”

- Program number choice screen appears. Have program number which you want to delete display and press jog dial.

Delete	P 0 1
Use 5	rest 1 0

(Choice screen for program number)

3. To confirm and choose “Yes”

- Confirmation screen to delete program appears. Check if it indicates the right program number to delete. Then choose “Yes” by jog dial and press it.

Delete it ?	No
Delete	P 0 1



Delete it ?	Yes
Delete	P 0 1

- ※ You can cancel if you choose “No” at this stage or press “Program Key”.

HANDING METHOD OF FUNCTION MENU

- Function menu has following 9 item of function (Full option installation)

No.	Name	Function	Option
1	Timer mode	Timer mode setup	
2	Key lock mode	Key lock mode setup	
3	Buzzer mode	Buzzer mode setup	
4	Calibration offset	Calibration offset temperature setup	
5	Acc. Time	Accumulated operation time setup	
6	Date time	Date time setup	
7	Fan spinning	Fan spinning speed setup	<input type="radio"/>
8	Damper opening	Damper opening degree setup	<input type="radio"/>
9	Comm. Lockout off	Communication lockout mode setup	<input type="radio"/>

To select function menu item

- Make sure that power is on.

- Press "Function menu key"

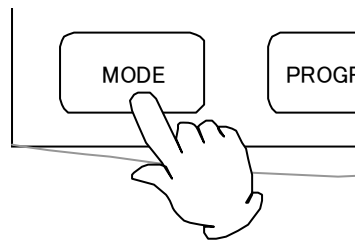

- Function menu starts up and item choice screen appears.

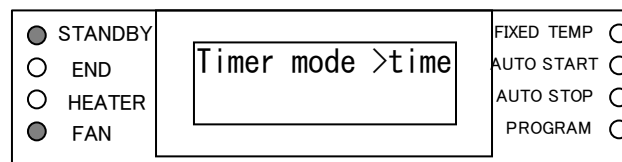

1. Turn “Jog dial”

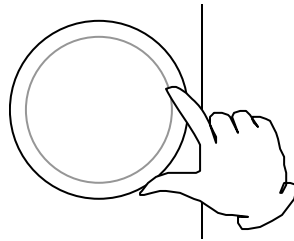

- Sub display shows name of item. Turn jog dial to choose one.

No.	Name	Sub display
1	Timer mode	Timer mode >time
2	Key lock mode	Key lock mode OFF
3	Buzzer mode	Buzzer mode ON
4	Calibration Offset	Calibrate $\pm 0^{\circ}\text{C}$
5	Acc. time	Acc. time 4 9 9 9 9 h r
6	Date Time	Date 1 9 9 9 - 1 2 - 3 1 Time 2 3 : 5 9
7	Fan	Fan 1 0
8	Damper	Damper 0 %
9	Comm. Lockout	Comm. Lockout OFF

2. Press “Jog dial”

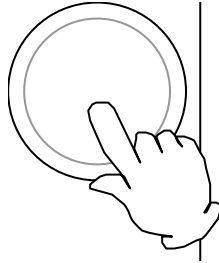

- Either input screen for each item or operation screen appears.

3. How to cancel

- If you want to cancel item choice halfway, press “Function menu key” again

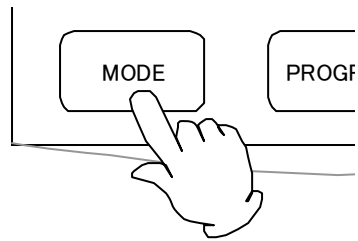

TO SET UP TIMER MODE

- ※ It is impossible to change contents of operating timer mode when auto start mode is setup in wait time ,auto stop is in operation and program operation mode is set up in wait time.

1. To choose the “Timer mode”

- On item choice screen in function menu, have “Timer mode” display and press jogdial.

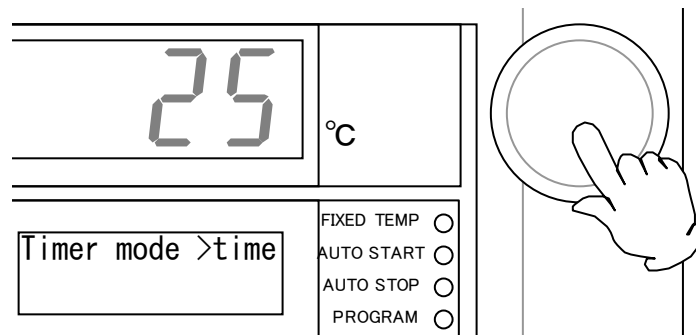

2. To choose “mode”

- “▶” Cursor disappears and current mode blinks. Turn jogdial and have either “Time” or “Clock” display.

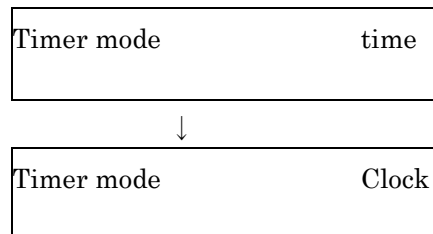

3. Press “Jogdial”

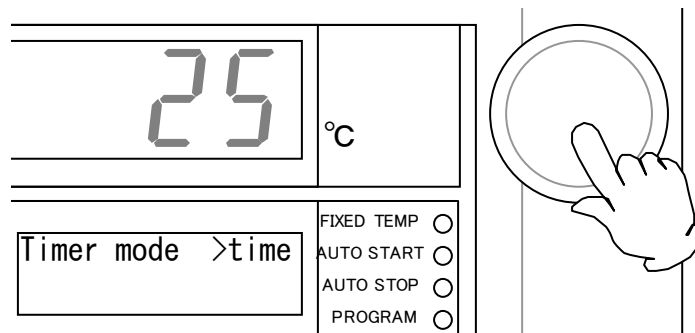

- Timer mode is fixed and it goes back to item choice screen in function menu.

1. To choose “Key lock mode”

- On item choice screen in function menu, have “Key lock mode” display and press jogdial

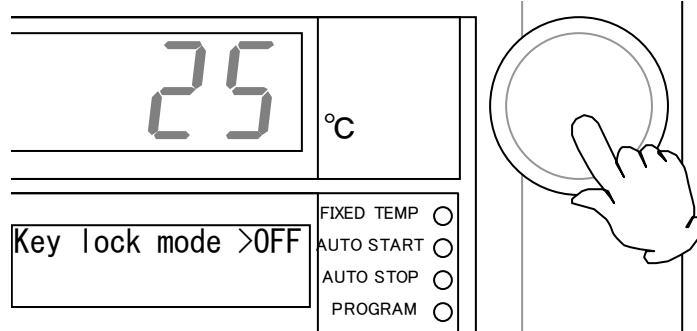

2. To choose “Mode”

- “▶” cursor disappears and current mode blinks. Turn jogdial to have either “On” or “Off” display.

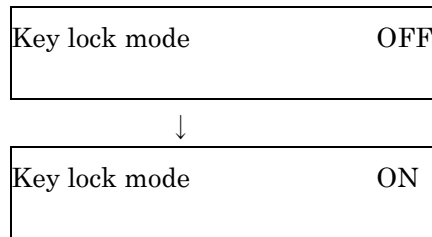

3. Press “Jogdial”

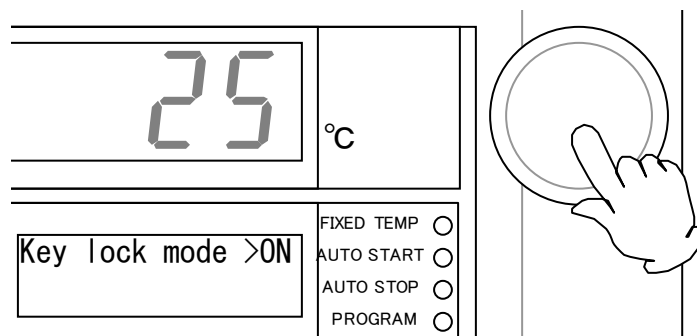

- Key lock mode is fixed and it goes back to item choice screen in function menu.

※ If you turn on “Key lock mode”, you cannot change content of program and setup content of some function menu. Sub display indicates “Key being locked”.

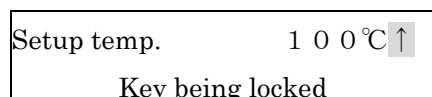

(Ex. In case of fixed temperature)

TO SET UP BUZZER MODE

1. To choose “Buzzer mode”

- On item choice screen in function menu, have “Buzzer mode” display and press jogdial.

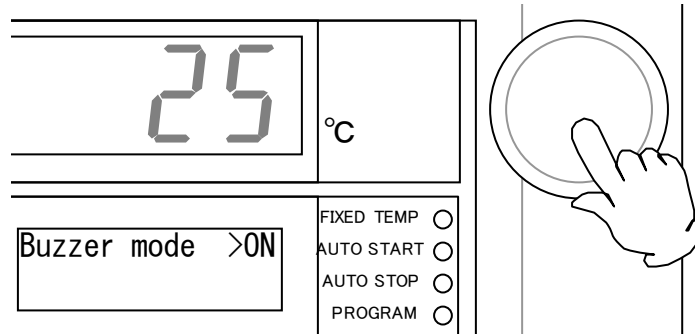

2. Choice of “Mode”

- “▶” Cursor disappears and current mode blinks. Turn jogdial to have either “On” or “Off” display.

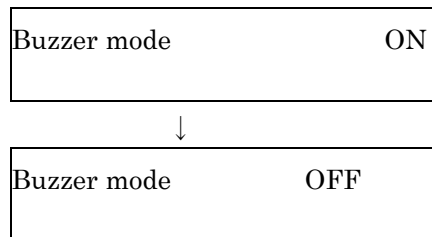

3. Press “Jogdial”

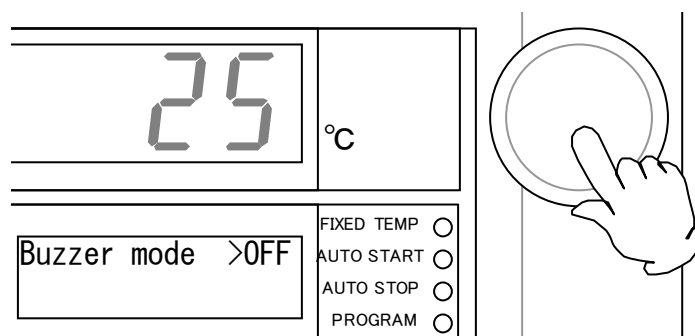

- Buzzer mode is fixed and it goes back to item choice screen in function menu.

※ If buzzer mode is “Off”, alarm buzzer in the abnormal, auto stop buzzer and program operation end buzzer don’t ring.

Outline of Function

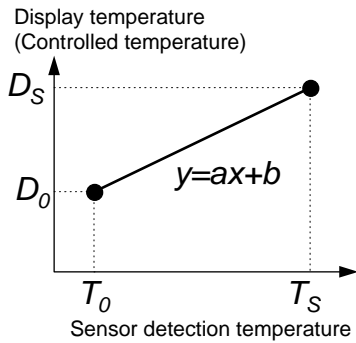

Fig. 1

In the controller, the relationship between the temperature T detected by the sensor and the display temperature of the operation panel D is expressed by the equation of the line which passes the two points (T_0, D_0) and (T_s, D_s) shown in Fig. 1.

Here, T_0 is the sensor detecting temperature when the chamber central temperature becomes the zero adjusting temperature (normally room temperature is adopted) D_0 at the time of no load, T_s is the sensor detecting temperature when the chamber central temperature becomes the span adjustment temperature (normally working maximum temperature is adopted) D_s at the time of no load in the same way.

As it is clear from the facts above, conforming of the chamber central temperature and the display temperature is guaranteed only when there is no load and at two points shown above. In other words, it is possible for a temperature measured at a point in the chamber does not conform to the display temperature of the operation panel at a voluntary temperature without load.

This is the function to move the line which passes above two points to the Y axis direction in parallel (increase or decrease y intercept of the line). The parallel movement amount including a sign is defined as the calibration offset. This function can conform the display temperature of the operation panel to the measurement temperature of a voluntary point in the chamber at a voluntary temperature.

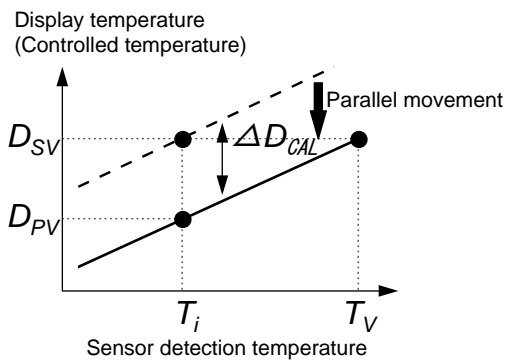

Fig. 2

In Fig. 2, D_{sv} is a display temperature of the operation panel under the condition that the temperature in the chamber is constant for a set temperature. It is natural to say that this value is equal to the target set temperature. D_{pv} is a measurement temperature of a voluntary point in the chamber under this condition. The difference between D_{pv} and D_{sv} including the sign is

$$\Delta D_{CAL} = D_{PV} - D_{SV} \quad \text{Equation 1}$$

defined as the calibration offset. Therefore offset is shown as below.

In Fig. 2, ΔD_{CAL} becomes the negative value since the target set temperature D_{sv} is larger than the actually measured temperature D_{pv} . In order to conform the display temperature to the actually measured temperature, let the controller to recognize that the temperature in the chamber differs from the target set temperature by ΔD_{CAL} .

NOTE: Setting Tolerance of Calibration Offset

- The calibration offset can be set within $\pm 5\%$ of the maximum working temperature of the oven.

(Therefore, the setting tolerance of the calibration offset is $\pm 19^{\circ}\text{C}$.)

- Initial off set value has been set to 0°C when shipping.

SETTING THE CALIBRATION OFFSET FUNCTION

1. To choose “Calibration offset”

- On item choice screen in function menu, have “Calibrate” display and press jogdial

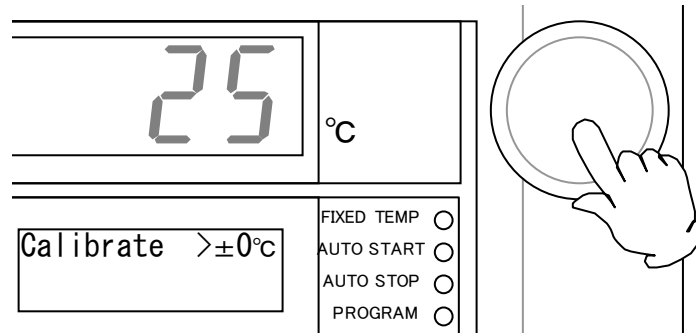

2. Input of “Offset temperature”

- “►” Cursor disappears and current offset temperature blinks. Turn jogdial to set temperature and have it display.

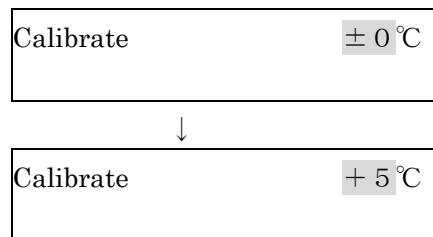

3. Press “Jogdial”

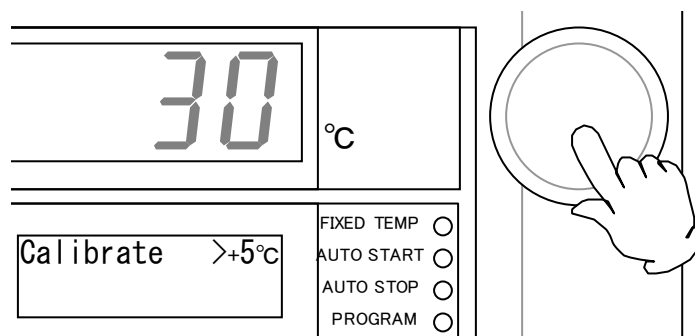

- Calibration offset temperature is fixed and it returns to item choice screen in function menu.

TO CHECK ACCUMULATED OPERATION TIME

- ※ "Accumulated operation time" is the function to check operation time of device.
It is impossible to change its content.

1. To have "Accumulated operation time" display

- On item choice screen in function menu, turn jog dial and have "Acc. Time" display.

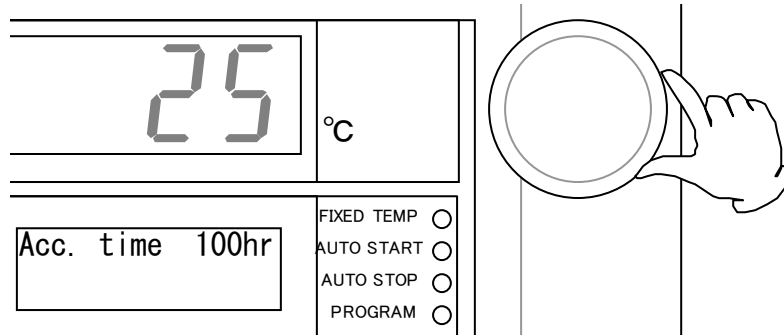

- It displays accumulated operation time from factory shipment to the present.

Acc. time	1 0 0 h r
-----------	-----------

- ※ Accumulated operation time is accumulation of time during which power is not off. Standby time, wait time and operation end time are also accumulated as operation time.

2. Press "Function menu key"

- After checking content, press "Function menu key" to cancel function menu.

- ※ At the time of factory shipment, clock is not set correctly. Adjust it according to time signal etc before using.
- ※ When timer mode is set for “Time”, if auto start mode is set, auto stop mode is in operation and program operation mode is set for wait time, it is impossible to change its setup content of clock. Try again after pressing “Power key and stop operation.

1. To have “Date · Time” display

- On item choice screen in function menu, turn jog dial and have “Date” and “Time” display.

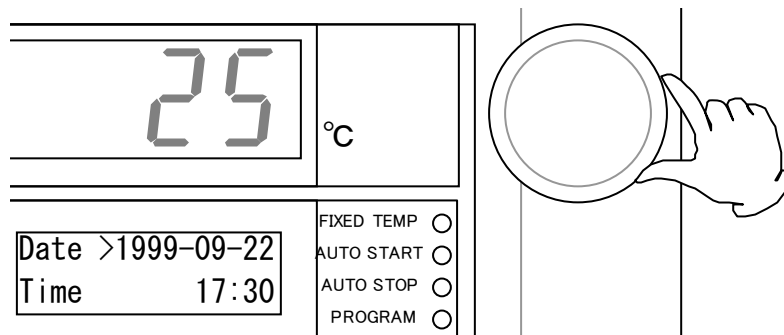

- Current date and time are displayed.

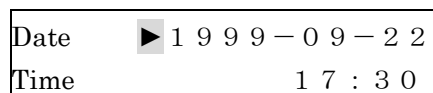

2. To choose “Setup item”

- If you turn jog dial, “▶” cursor moves from “Year”, “Month”, “Time”, and “Minute” in order. Choose item which you want to set and press jog dial.

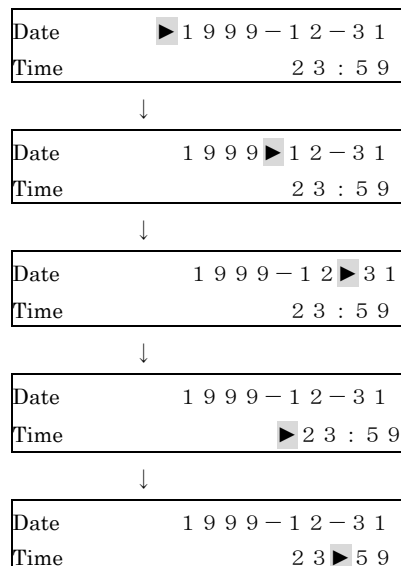

3. Input of "Setup figure"

- "►" cursor disappears and current setup figure blinks.

Date	1 9 9 9 - 0 9 - 2 2
Time	1 7 : 3 0



Date	2 0 0 0 - 0 9 - 2 2
Time	1 7 : 3 0

4. Press "Jpgdial"

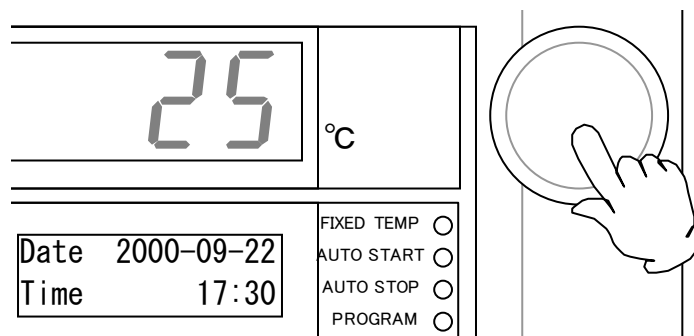

- Setup figure of chock is fixed and it returns to item choice screen in function menu.

TO MODULATE FAN BLADE(OPTION)

- ※ In the following case setup figure of fan speed by each operation mode is displayed and is impossible to change it.
 - i) When operation ends by auto stop operation mode and function parameter is off
 - ii) While program operation mode is in operation or it stops after operation.
 - iii) In case of remote operation mode.

1. To have “Fan” display

- On item choice screen in function, have “Fan” display and press jogdial.

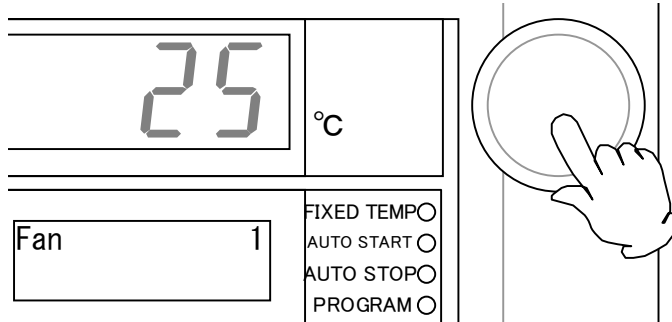

2. To decide fan spinning speed

- “▶” Cursor disappears and current setup speed blinks. Turn jogdial to decide the speed from 1~10 and have it display.

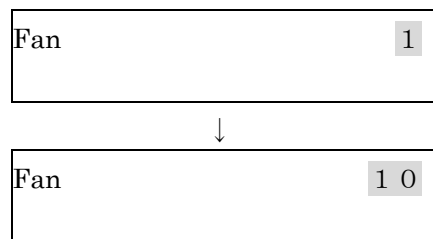

3. Press “Jogdial”

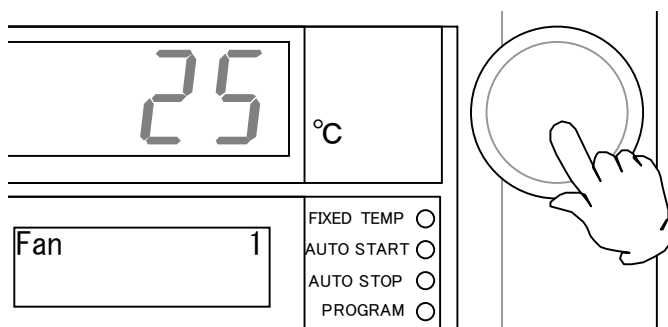

- Fan spinning speed is fixed and it returns to item choice screen in function menu.

*If the speed is set from 1 to 6, it makes sound. This is because of wind control and there is no problem in performance.

TO MODULATE DAMPER (OPTION)

※ It is impossible to change the content while it is in program operation, after the operation ends or when it is in remote operation mode.

1. To have “Damper” display

- On item choice screen in function menu, have “Damper” display and press jog dial.

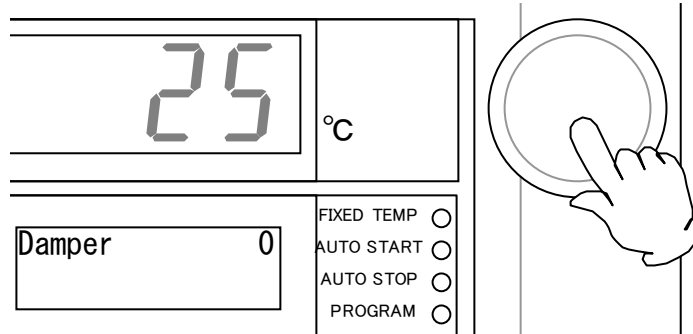

To decide damper opening degree.

- “▶” Cursor disappears and current damper opening degree blinks.

(At the time of shipment from factory, it is entirely closed.)

Turn jog dial to choose one from among five degrees, “0”, “25”, “50”, “75”, or “100” and have it display.

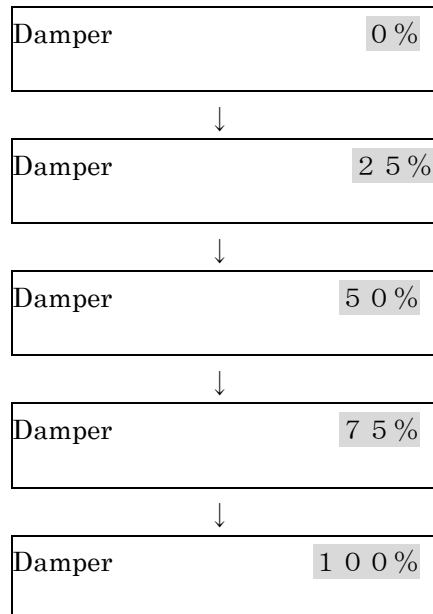

2. Press “Jog dial”

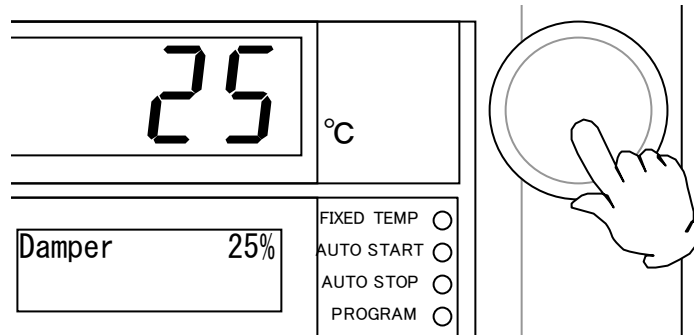

Damper opening degree is fixed and it returns to item choice screen in function menu.

SETTING THE COMMUNICATION LOCKOUT (OPTIONAL)

1. To choose "Comm. Lockout"

- On item choice screen in function menu, have "Comm. Lockout" display and press jog dial.

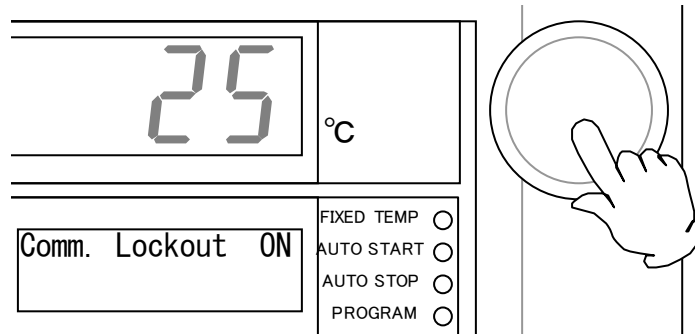

2. To choose "Comm. Lockout"

- "►" Cursor disappears and current mode blinks. Turn jog dial and have either "On" or "Off" display.

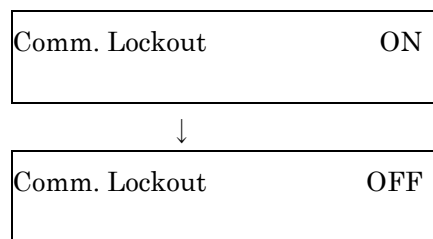

3. Push the JOGDIAL

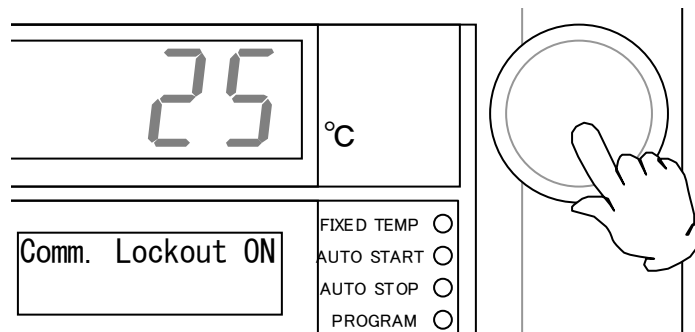

- Communication lockout is set and it returns to item choice screen in function menu.

INDEPENDENT OVERHEAT PREVENTION

There are two safety devices in this unit: the auto-overheating preventive function of the controller (automatic recovery) and the independent overheating prevention (manual recovery). Circuits and sensor that are independent from the controller configure them. These safety devices for the temperature overheating prevention protect the instrument in a fail-safe method.

Setting the Temperature Range and Function

Setting Temperature:	0 to 399°C
Input Method:	Three integer digital switch. Turn the drum of each column and set the desired value. The first integer can only be from 0 to 3 for hundred columns.
Function:	Heater output is cut off when the measured temperature gets higher than the set temperature of the independent overheating prevention. The function is active when the earth leakage breaker is ON. When the independent overheating prevention is activated, is flashing on the main display with the TROUBLE lamp flashes. When the independent overheat prevention is active while the heater is in the temperature rising process, etc., and flash alternately on the display.

Activation/Setting Method

1. Set the independent overheating prevention 15°C higher than the set temperature of the main unit.
2. The purpose of overheating prevention device is to protect the unit from overheating. It does not intend to protect the sample, or to protect them from the accident caused by the use of explosive or inflammability. The temperature is set to 275°C DF411/611, to 375°C DH411/611 at factory shipment.
3. When the independent overheating prevention is activated improperly by changing the setting of the independent overheating prevention lower than the internal temperature or by continuing operation when the setting on the unit is too low, turn off the earth leakage breaker to reset the unit and perform the setting again. If it is activated by another reason, see chapter of Safety Devices and Error Codes on page 14.

Precautions

1. Only 0 to 3 can be set for the column of hundreds of the digital switch by the stop mechanism; however, if forced it to a value higher than 3, it will damage the unit.
2. Set temperature can change by touching the setter when cleaning. Always confirm that the set temperature is correct after cleaning or before operation.

Daily check/care



WARNING

- Before starting inspection or maintenance, disconnect the power plug from the receptacle.
- Conduct inspection and maintenance only after the oven has cooled down.
- When you remove dirt or stains from the unit's resin parts and the control panel, use a soft wet cloth. Do not use benzene, thinner, cleanser or a hard brush; it will cause deformation, qualitative deterioration and/or discoloring of the components.

Monthly servicing

- Examine short circuit breaker function.
 - Put power supply code in and test it with electricity turned on.
 - First, turn on short circuit breaker.
 - Next, press red test button on short circuit breaker by using the point of ballpoint pen etc. If short circuit is turned off, then it is normal.
- After executing the fixed temperature operation at the set temperature 0°C, set the operation temperature of the Independent Temperature Overheating Prevention Device to 0°C.
- Under normal circumstances, the heater circuit is cut off in a few seconds and the **TROUBLE** lamp and *Er.07* flashes at the same time, and the alarm buzzer sounds if the alarm buzzer function is ON.
- After confirming, turn off the circuit breaker once, then return the setting of the Independent Temperature Overheating Prevention Device to the proper value. Turn the circuit breaker back ON.

If there is any question, contact our sales representative in your vicinity or our service office at once.

LONG STORAGE AND DISPOSAL

When you do not use the oven for a long period of time



CAUTION

Long Storage and Disposal

- Disconnect the power plug from the receptacle



WARNING

When you dispose of the oven.

- Do not leave it where children can access. Remove the knob and hinges of the door to disable the door locking system.

AFTER SERVICE AND WARRANTY

If a Service Call is required

- If a problem occurs with the Drying Oven, record the error code on the display and stop the operation immediately, turn off the power switch, and disconnect the power plug from the receptacle. Contact our sales or service representative.
- Check the warranty card or the name plate of your Drying Oven and give us the information below.
 - Model of your oven;
 - Serial product number of your oven;
 - Date of purchase; and
 - Problem with your oven (as detailed as possible).

Warranty Card (attached to your Oven)

- Please fill out completely and return the bottom portion of the warranty card when the unit is received. The completed top portion is your Registration Card that should be retained for your records.
- Warranty period is one (1) year after the date of your purchase. During this warranty period, we will offer free repair service on the basis of the conditions provided on the warranty card.
- If you need repair service after expiration of the warranty period, contact our sales or service representative in your vicinity or service office for advice.

Minimum Inventory Period of Repair Parts

Repair parts will be available for at least 7 years after termination of our production of DF · DH Fain Oven Series. Repair parts mean the parts that are necessary to maintain the performance of the ovens.

TROUBLESHOOTING

Problem	Cause/Solution
The display on the control panel is blank when the power switch is turned on.	<ul style="list-style-type: none"> • Check if the power cable is firmly connected to a receptacle. ▪ Check for power failure.
Temperature fluctuates during the operation	<ul style="list-style-type: none"> • Does ambient temperature fluctuate violently? • Are there too many specimens in the chamber? ▪ Are the specimens too moist?
Drying time is too long	<ul style="list-style-type: none"> • Did the power voltage drop? ▪ Did you change the aperture of the exhaust port?

Model	DF411	DF611	DH411	DH611
Performance				
Operating temperature	+40~260°C		+40~360°C	
Temperature stability*1	±0.1°C (at 260°C)		±0.2°C (at 360°C)	
Temperature uniformity*1	±1.5°C (at 260°C)		±2.5°C (at 360°C)	
Time to reach mix. temp.*1	60 min (to 260°C)		80 min (to 360°C)	
Function / structure:				
Temperature control method	PID control by microprocessor			
Temperature / timer setting method	Digital setting and display by jogdial			
Temperature indicating method	Digital indication by green LED			
Other indication	Text display by fluorescent display that indicates function information			
Timer	1 min. to 99 hrs.59min. or 100 hrs to 999hrs			
Operation function	Fixed temperature operation、 Auto-start/Auto-stop operation Program operation(16 segments, repeat etc.)			
Additional function	Calendar timer function (actual hr.timer within 24 hrs.) Integrating time function (Integrated hr.up to 49999 hrs.can be measured.) Time indication(The present time is indicated) Calibration offset function.			
Safety device	Short circuit breaker, Self-diagnostic function(sensor abnormality, heater disconnection and Triac short circuit detection;automatic temperature over-rise prevention) Key lock function, Door switch, Control box switch, Independent Temperature Overheat Prevention device			
Sensor	K thermocouple (double sensor)			
Heater	Stainless steal pipe heater with fan			
Heater nominal capacity (kW)	2.1	3.0	2.7	3.75
Fan	Shaft current fan (Condenser 20W)			
Cable port	Inner diameter 30mm (rear face)			
Insulation	Glass wool		Ceramic fiber	
Other additional structure	Exhaust damper (Manual operation)			
Internal dimensions*2 (W×D×H mm)	450×450×450	600×600×600	450×450×450	600×600×600
External dimensions*2 (W×D×H mm)	1,050×630×約50	1200×780×1000	1050×630×850	1200×780×1000
Capacity (l)	91	216	91	216
Shelf board weight capacity	Approx 30 (kg)			
Shelf brackets	9			
Shelf brackets pitch	45	60	45	60
Power Requirements 50/60Hz	AC200V 11A Single phase	AC200V 16A Single phase	AC200V 14A Single phase	AC200V 20A Single phase
Weights (kg)	Approx 78	Approx 109	Approx 78	Approx 109

Accessories	Shelf board (Stainless steel wire)			
	2 (Shelfbracket 4)	3 (Shelf bracket 6)	2 (Shelf bracket 4)	3 (Shelf bracket 6)
Option	① Temperature output terminal ② Timeup output terminal ③ External alarm terminal ④ Auto damper ⑤ Analog recorder(6 inscription type) ⑥ External communication adaptor ⑦ Observation window ⑧ Sensor addition(Triple sensor) ⑨ Exhaust duct ⑩ Exhaust port flange ⑪ Set stage ⑫ Set stage caster ⑬ Set metal fittings ⑭ Abnormality alarm display lamp ⑮ Emergency stoppage switch ⑯ Shelf board(For each type of machine) ⑰ Starting condition choice screen ⑱ Wind velocity variation device ⑲ Power supply code ⑳ Power supply plug			

*1 The performance value is in the condition of circulation operation(Damper is entirely closed),room temperature $23^{\circ}\text{C} \pm 5^{\circ}\text{C}$ 、 humidity $65\% \text{RH} \pm 20\%$ and no load.

*2 Internal and external dimensions do not include protruding parts

DF411

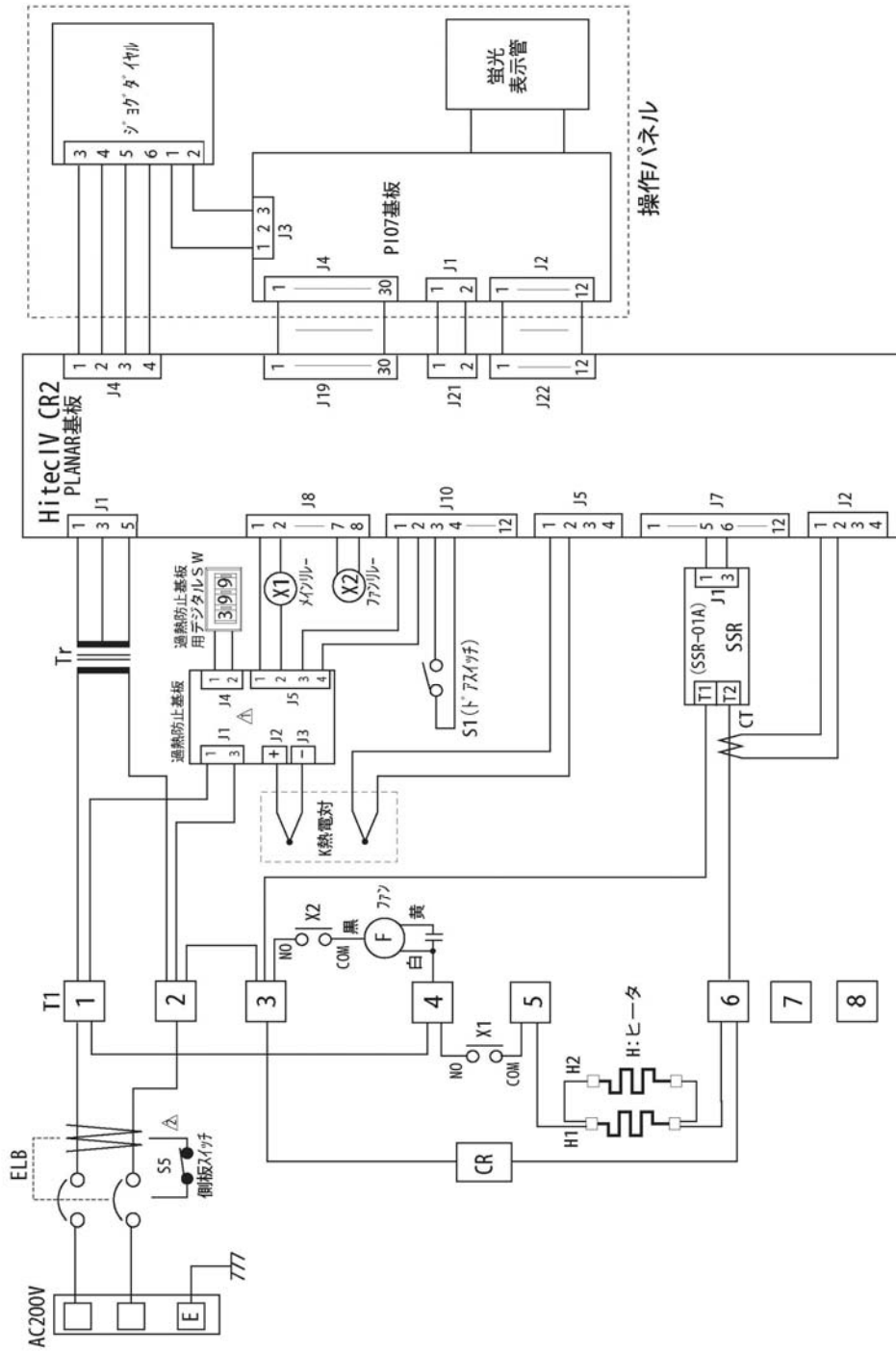

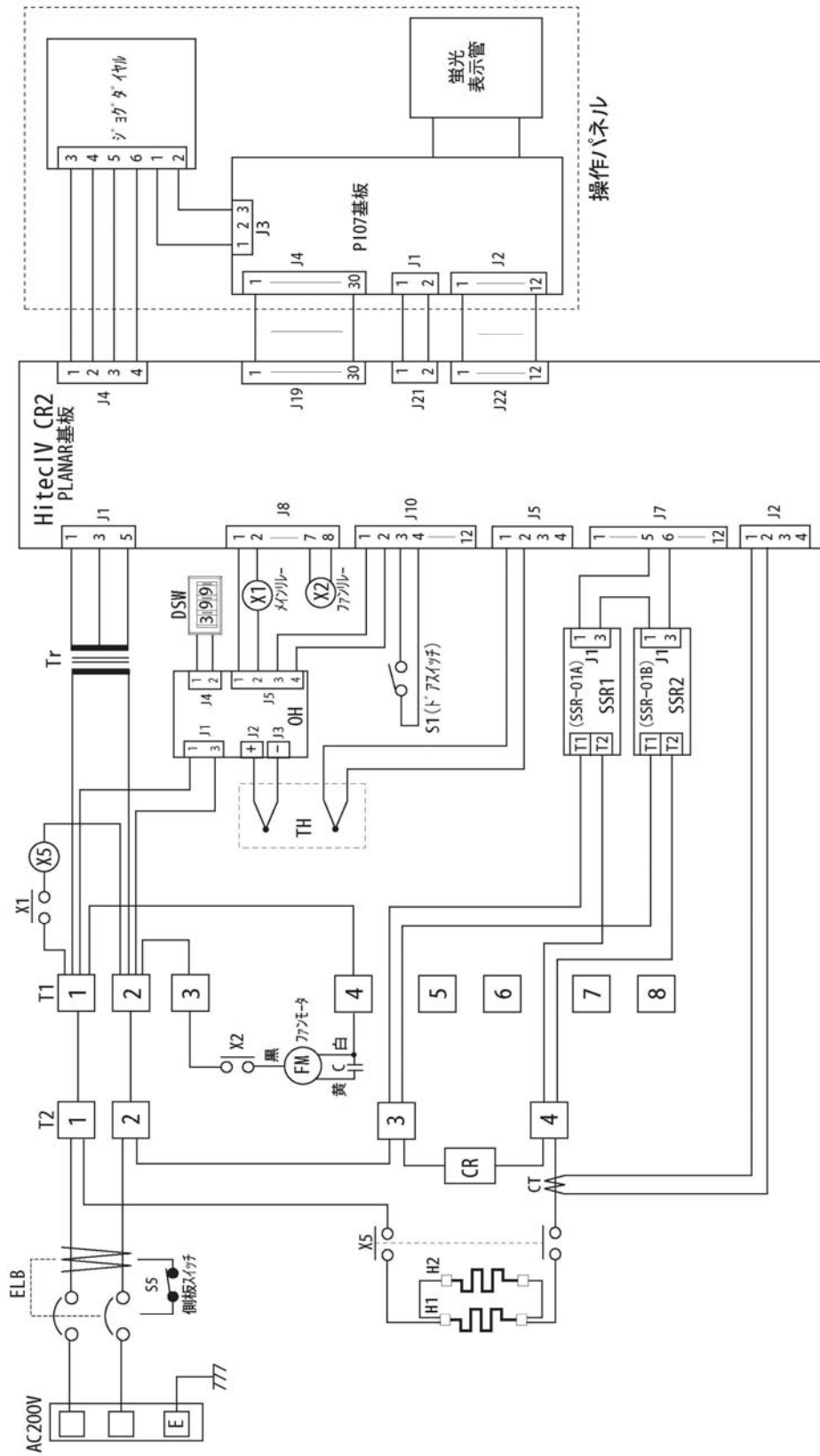

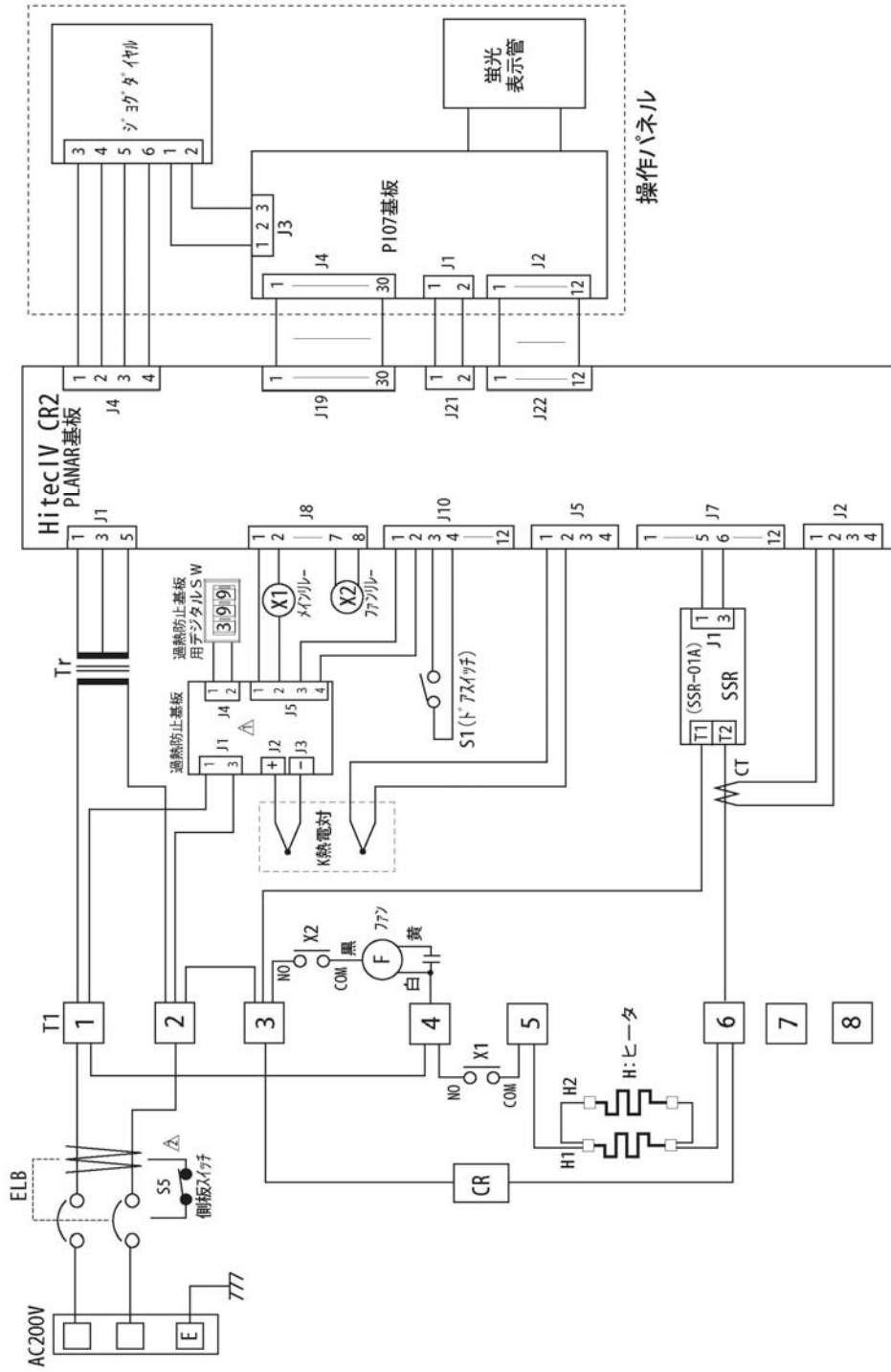

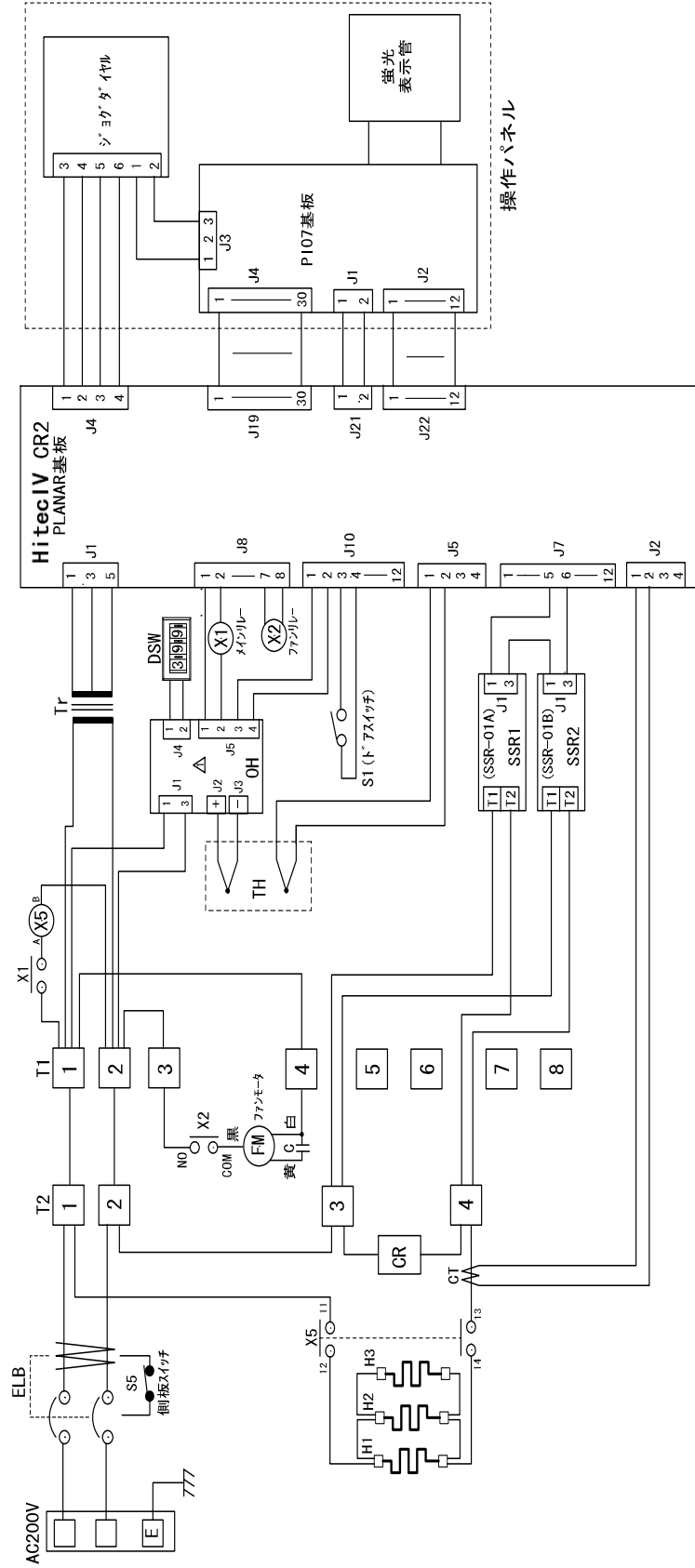

REPLACEMENT PARTS TABLE

DF411

Symbol	Part Name	Code No.	Specifications
CT	Current Transformer	2-17-001-0002	CTL-6-S-400
E LB	Circuit breaker	LT00034878	BJS1532NTBL
F	Motor	2-14-001-0027	BKREK74L-4, AC200V
H1,2	Heater	DE42S-30251	AC200V 1050W
	PIO7 board	1-24-000-0084	
	PLANAR board	1-24-000-0120	IVTYPR CR2
	Independent overheat prevention	LT00022041	A7CN-206
SSR	Solid-state relay	LT00028423	SSR-01
Tr	Transformer	2-18-000-0042	200V CR
SW	Digital switch	2-01-010-0005	TypeIVOH
X1,2	Relay	2-05-000-0013	AHN36006
T1	Terminal base	LT00031664	TFD250ABC-8P
S5	Side switch	2-02-007-0007	VX-54-1A3
	Read relay	LT00035254	Omron LAB1(recreation)
	Thermocouple	1-16-001-0052	K thermocouple (double sensor)
CR	CR absorber	2-30-002-0001	2S1201 250V

DF611

Symbol	Part Name	Code No.	Specifications
CT	Current Transformer	2-17-001-0002	CTL-6-S-400
E LB	Circuit breaker	LT00034879	BJS2032NTBL
F	Motor	2-14-001-0027	BKREK74L-4, AC200V
H1,2	Heater	DF62S-30251	AC200V 1500W
	PIO7 board	1-24-000-0084	
	PLANAR board	1-24-000-0120	IVTYPE CR2
	Independent overheat prevention	LT00022041	A7CN-206
SSR1	SSR01-A	LT00028427	SSR-01A
SSR2	SSR-01-B	LT00028425	SSR-01B
Tr	Transformer	2-18-000-0042	200V CR
SW	Digital switch	2-01-010-0005	TypeIVOH
X1,2	Relay	2-05-000-0013	AHN36006
X5	Electromagnetic contact	LT00034006	FC-1 1a1b 200V
T1	Terminal base	LT00031664	TFD250ABC-8P
S5	Side switch	2-02-007-0007	VX-54-1A3
	Read relay	LT00035254	Omron LAB1(recreation)
	Thermocouple	1-16-001-0052	K thermocouple (double sensor)
CR	CR absorber	2-30-002-0001	2S1201 250V

REPLACEMENT PARTS TABLE

DH411

Symbol	Part Name	Code No.	Specifications
CT	Current Transformer	2-17-001-0002	CTL-6-S-400
E LB	Circuit breaker	LT00034879	BJS2032NTBL
F	Motor	2-14-001-0027	BKREK74L-4, AC200V
H1,2	Heater	DE42S-30251	AC200V 1050W
H3	Heater	DH42S-30000	AC200V 600W
	PIO7 board	1-24-000-0084	
	PLANAR board	1-24-000-0120	IVTYPE CR2
	Independent overheat prevention	LT00022041	A7CN-206
SSR	Solid-state relay	LT00028423	SSR-01
Tr	Transformer	2-18-000-0042	200V CR
SW	Digital switch	2-01-010-0005	Type IVOH
X1,2	Relay	2-05-000-0013	AHN36006
T1	Terminal base	LT00031664	TFD250ABC-8P
S5	Side switch	2-02-007-0007	VX-54-1A3
	Read relay	LT00035254	Omron LAB1(recreation)
	Thermocouple	1-16-001-0052	K thermocouple (double sensor)
CR	CR absorber	2-30-002-0001	2S1201 250V

DH611

Symbol	Part Name	Code No.	Specifications
CT	Current Transformer	2-17-001-0002	CTL-6-S-400
E LB	Circuit breaker	LT00034880	BJS3032NTBL
F	Motor	2-14-001-0027	BKREK74L-4, AC200V
H1,2	Heater	DF62S-30251	AC200V 1500W
H3	Heater	DH62S-30000	AC200V 750W
	PIO7 board	1-24-000-0084	
	PLANAR board	1-24-000-0120	IVTYPE CR2
	Independent overheat prevention	LT00022041	A7CN-206
SSR1	SSR01-A	LT00028427	SSR-01A
SSR2	SSR-01-B	LT00028425	SSR-01B
Tr	Transformer	2-18-000-0042	200V CR
SW	Digital switch	2-01-010-0005	Type IVOH
X1,2	Relay	2-05-000-0013	AHN36006
X5	Electromagnetic contact	LT00034006	FC-1 1a1b 200V
T1	Terminal base	LT00031664	TFD250ABC-8P
S5	Side switch	2-02-007-0007	VX-54-1A3
	Read relay	LT00035254	Omron LAB1(recreation)
	Thermocouple	1-16-001-0052	K thermocouple (double sensor)
CR	CR absorber	2-30-002-0001	2S1201 250V

Instruction Manual for

Fine Oven

DF411/611 DH411/611

Third Edition **Nov. 20, 2009**

Revised **May. 14, 2012**

Yamato Scientific Co., Ltd.
2-1-6 Nihonbashi Honcho, Chuo-ku,
Tokyo, 103-8432, Japan
<http://www.yamato-net.co.jp>