

## FEATURES:

- All outputs are regulated
- High reliability planar xmer design
- Ultra low ripple & noise
- No external capacitor required
- High power density
- High efficiencies to 90%
- Fully isolated to 1500Vdc
- 1.0" x 2.0" x 0.45" form factor
- -55 to +100°C operation available

## Ordering Guide

Model	Output						Input			Eff. (%) <sup>5</sup>		Options		
	Vout (Volts)	Iout (A, max)	Power <sup>1</sup> (Watt)	mVp-p <sup>2</sup>		Regulation <sup>3</sup>		Vin	Range	Iin <sup>4</sup> (mA)	Eff. (%) <sup>5</sup>			
				Ripple	Noise	Line	Load				min.		typ.	
DH25D12005	+5.0 -5.0	+2.5 -2.5	25	12 35	20 35	±0.2	±0.5	12	9-20	80	86	88	C, MC	
DH25D2405								24	18-36	60	89	91		
DH25D4805								48	36-60	60	87	89		
DH25D24W05								24	9-36	60	89	91		
DH25D48W05								48	18-60	60	87	89		
DH50D1205		+5.0 -5.0	+5.0 -5.0	50	25 70			30 75	12	9-20	80	86		88
DH50D2405									24	18-36	60	88		90
DH50D4805									48	36-75	60	87		89
DH50D24W05									24	9-36	60	88		90
DH50D48W05									48	18-75	60	87		89
DH25D1210	+10 -10	+1.25 -1.25	25	25 25	30 30	12	9-20	40	85	87				
DH25D2410						24	18-36	30	87	89				
DH25D4810						48	36-75	20	86	88				
DH25D24W10						24	9-36	30	87	89				
DH25D48W10						48	18-75	20	86	88				
DH50D1210		+2.5 -2.5	+2.5 -2.5	50	55 55	60 60	12	9-20	40	82	84			
DH50D2410							24	18-36	30	83	85			
DH50D4810							48	36-75	20	84	86			
DH50D24W10							24	9-36	30	83	85			
DH50D48W10							48	18-75	20	84	86			
DH25D1212	+12 -12	+1.0 -1.0	25	25 25	30 30	12	9-20	40	86	88				
DH25D2412						24	18-36	30	89	91				
DH25D4812						48	36-75	20	87	89				
DH25D24W12						24	9-36	30	89	91				
DH25D48W12						48	18-75	20	87	89				
DH50D1212		+2.1 -2.1	+2.1 -2.1	50	60 60	65 65	12	9-20	40	86	88			
DH50D2412							24	18-36	30	87	89			
DH50D4812							48	36-75	20	87	89			
DH50D24W12							24	9-36	30	87	89			
DH50D48W12							48	18-75	20	87	89			

...Continue

## Ordering Guide (Continued)

Model	Output						Input			Eff. (%) <sup>5</sup>		Options			
	Vout (Volts)	Iout (A, max)	Power <sup>1</sup> (Watt)	mVp-p <sup>2</sup>		Regulation <sup>3</sup>		Vin	Range	Iin <sup>4</sup> (mA)	min.		typ.		
				Ripple	Noise	Line	Load								
DH25D1215	+15 -15	+0.84 -0.84	25	25	35	$\pm 0.2$	$\pm 0.5$	12	9-20	40	86	88	C, MC, TS		
DH25D2415								24	18-36	30	89	91			
DH25D4815								48	36-75	20	87	89			
DH25D24W15								24	9-36	30	89	91			
DH25D48W15								48	18-75	20	87	89			
DH50D1215		+1.7 -1.7	50	70	75			25	35	12	9-20	40		86	88
DH50D2415										24	18-36	30		88	90
DH50D4815										48	36-75	20		88	90
DH50D24W15										24	9-36	30		88	90
DH50D48W15										48	18-75	20		88	90

<sup>1</sup> Total max. output power.

<sup>2</sup> Max. +V1/-V2 ripple and noise; measured without external capacitor, 20MHz B.W.

<sup>3</sup> Balanced 10% to 100% load.

<sup>4</sup> No load input current.

<sup>5</sup> Nominal line voltage and full load.

## BLOCK DIAGRAM: $\pm 5.0V$

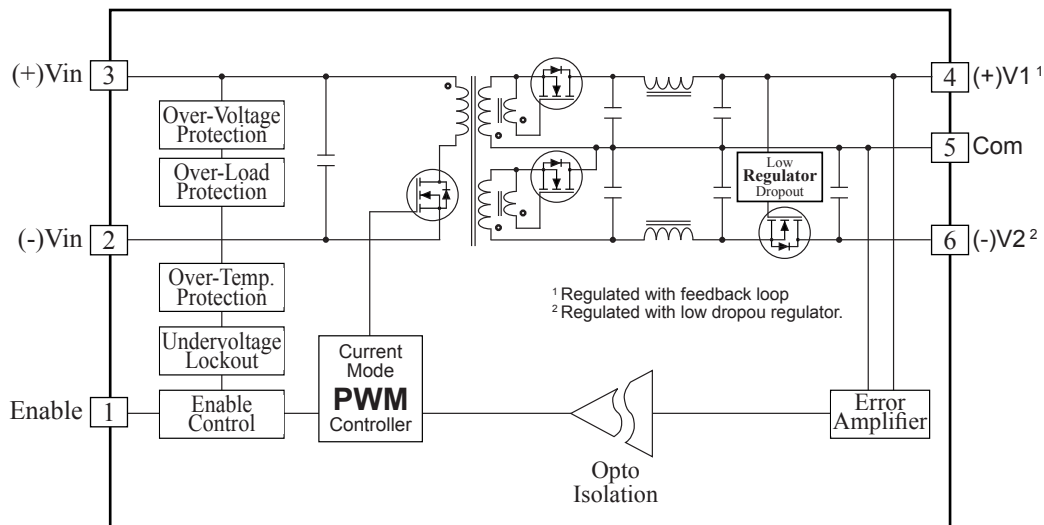

## BLOCK DIAGRAM: $\pm 10V$ ; $\pm 12V$ ; $\pm 15V$

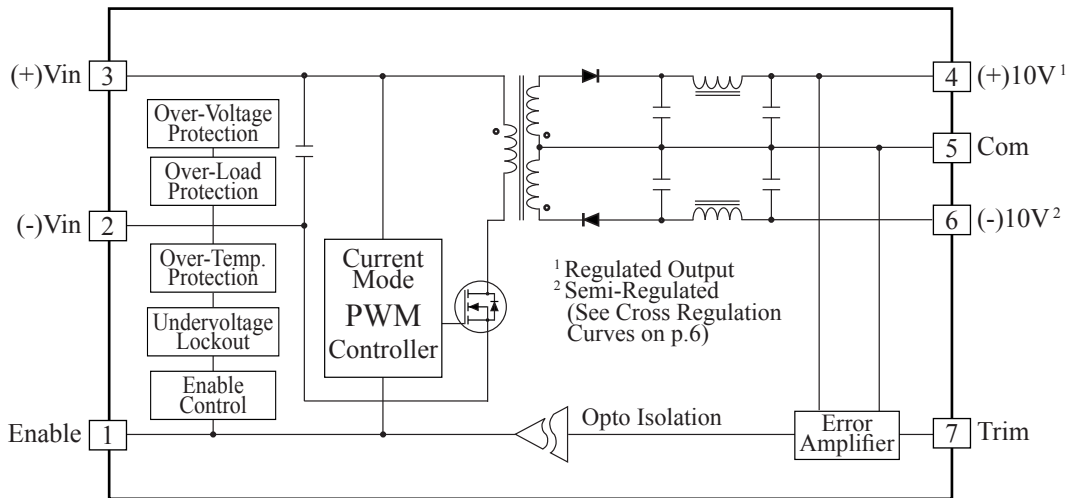

### INPUT SPECIFICATIONS:

All specifications apply over specified input voltage, output load, and temperature range, unless otherwise noted.

Model No./Parameter	Condition/Description	Min	Nom	Max	Unit
<b>DHxxD12xx</b> (Vin = 9 - 20V)	Input Voltage Range (Continuous)	9	12	20	VDC
	Input Transient Withstand (100mSec)			30	VDC
	Input Over Voltage Protection		21		VDC
	Output ON (Input Ramping Up)	8.8		9.0	VDC
	Output OFF (Input Ramping Down)	8.2		8.8	VDC
<b>DHxxD24xx</b> (Vin = 18 - 36V)	Input Voltage Continuous	18	24	36	VDC
	Input Transient Withstand (100mSec)			50	VDC
	Input Over Voltage Protection		37		VDC
	Output ON (Input Ramping Up)	17.8		18	VDC
	Output OFF (Input Ramping Down)	17.2		17.6	VDC
<b>DHxxD48xx</b> (Vin = 36 - 75V)	Input Voltage Continuous	36	48	75	VDC
	Input Transient Withstand (100mSec)			100	VDC
	Input Over Voltage Protection		77		VDC
	Output ON (Input Ramping Up)	35.6		36	VDC
	Output OFF (Input Ramping Down)	35		35.6	VDC
<b>DHxxD24Wxx</b> (Vin = 9 - 36V)	Input Voltage Continuous	9	24	36	VDC
	Input Transient Withstand (100mSec)			50	VDC
	Input Over Voltage Protection		37		VDC
	Output ON (Input Ramping Up)	8.8		9.0	VDC
	Output OFF (Input Ramping Down)	8.2		8.8	VDC
<b>DHxxD48Wxx</b> (Vin = 18 - 75V)	Input Voltage Continuous	18	48	75	VDC
	Input Transient Withstand (100mSec)			100	VDC
	Input Over Voltage Protection		77		VDC
	Output ON (Input Ramping Up)	17.8		18	VDC
	Output OFF (Input Ramping Down)	17.2		17.6	VDC
Input Current	Disabled		8	10	mA
Enable (On/Off) Control	POSITIVE Enable Only				
	Positive Control <sup>1</sup>	+2.4		+18	VDC
	Negative Control	0		+1.8	VDC
	Source or Sink current			1.0	mA

<sup>1</sup> Enable Pin Floating = POSITIVE Control.

### OUTPUT SPECIFICATIONS:

All specifications apply over specified input voltage, output load, and temperature range, unless otherwise noted.

Parameter		Condition/Description	Min	Nom	Max	Unit
Output Voltage	+5.0V	Input Voltage = Nom	+4.95	+5.00	+5.05	VDC
	-5.0V	Output Current = Balanced Loads, Max	-4.90	-5.00	-5.10	VDC
Output Current	+5.0V	Baseplate Temperature =< +90°C	0 <sup>1</sup>		+3.0	A
	-5.0V		0		-2.5	A
Line Regulation	+5.0V	Input Voltage = Min to Max			±0.2	%
	-5.0V	Output Current = Balanced Loads, Max			±0.5	%
Load Regulation	+5.0V	Input Voltage = Nom, Current = Min to Max			±0.5	%
	-5.0V	Please see regulation curves on p.6			±2.0	%
Ripple & Noise	+5.0V	Ripple		8	12	mVp-p
		Spike (20MHz B.W.)		12	20	mVp-p
	-5.0V	Ripple		25	35	mVp-p
		Spike (20MHz B.W.)		25	35	mVp-p
Transient Response (75% - 100% step Load)	+5.0V	Peak Deviation		±30	±50	mV
		Settling Time		100	120	µSec
Over Voltage Protection	+5.0V	FeedBack Loop Voltag Clamp		+6.5		VDC
Short Circuit Protection		Hiccup Mode Indefinite, Automic Recovery				
Start-Up		Resistive Load		1.0	1.5	mSec

<sup>1</sup>(+5V min. load required for (-)5V regulation, please see regulation curves on page 6.

### Output Ripple & Noise

(Measured with no external capacitor, 20MHz B.W.)

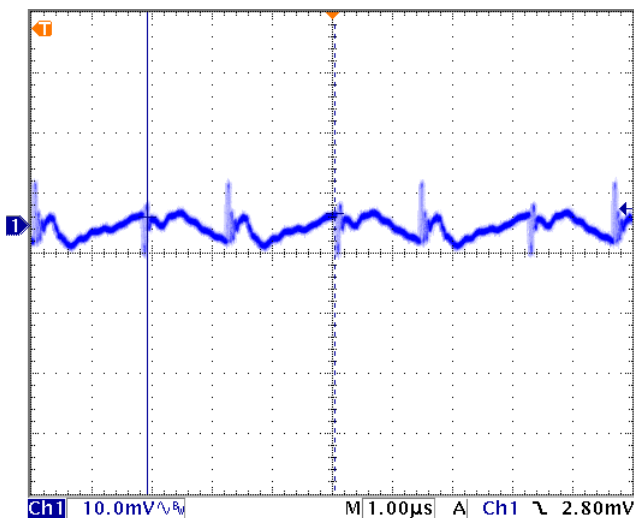

+5.0V

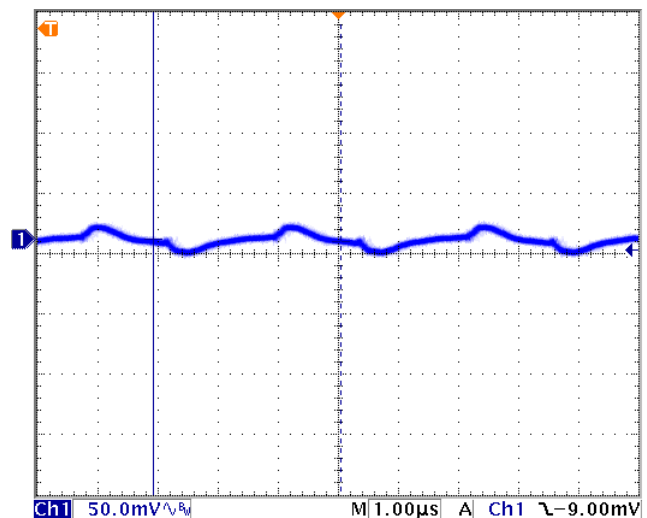

-5.0V

### Output Load Transient

(75% to 100% Step Load change)

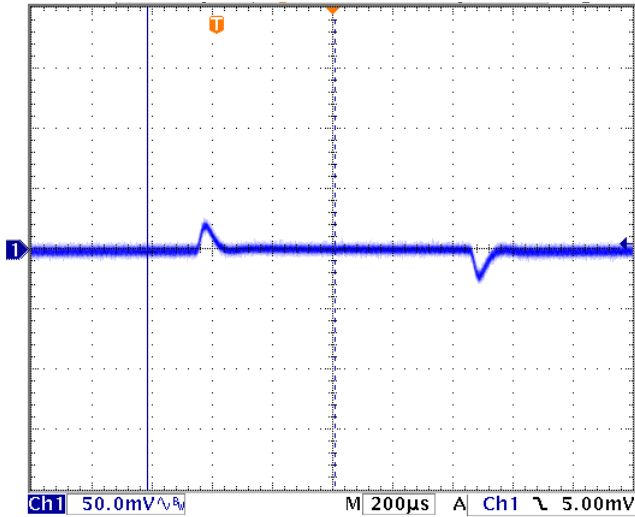

+5.0V

### Start-Up

(Resistive, Full Load)

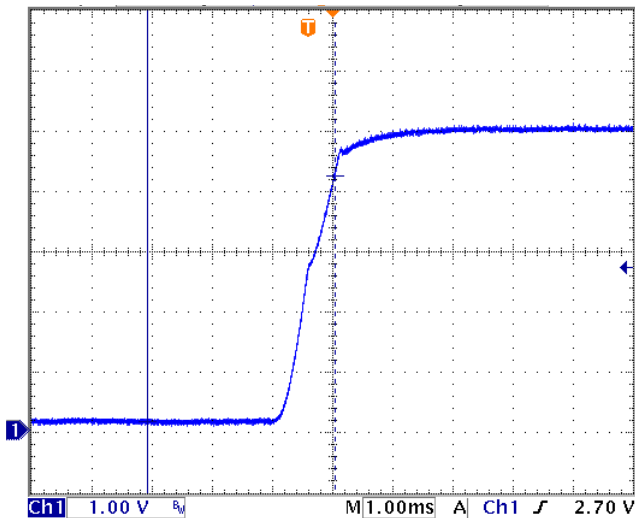

+5.0V

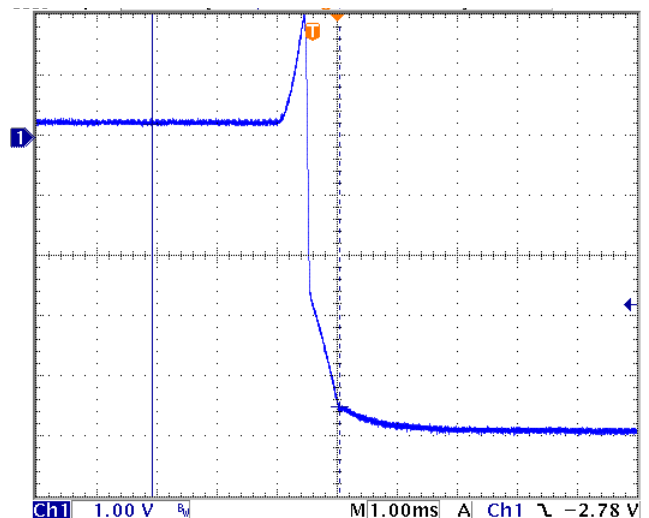

-5.0V

### Efficiency Curves

(Measured @ Baseplate Temp < 50°C)

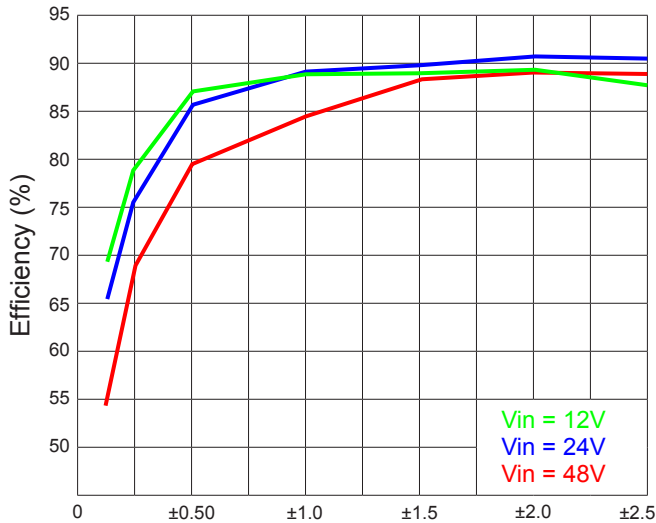

Load Current (A)

### Cross Regulation

(±15V Unbalanced Loads)

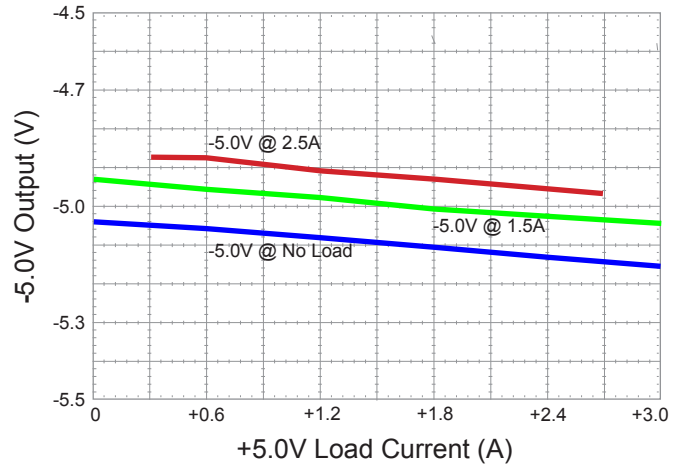

-5.0V Regulation Curves

### OUTPUT SPECIFICATIONS:

All specifications apply over specified input voltage, output load, and temperature range, unless otherwise noted.

Parameter		Condition/Description	Min	Nom	Max	Unit
Output Voltage	+5.0V	Input Voltage = Nom	+4.95	+5.00	+5.05	VDC
	-5.0V	Output Current = Balanced Loads, Max	-4.90	-5.00	-5.10	VDC
Output Current	+5.0V	Baseplate Temperature =< +90°C	0 <sup>1</sup>		+6.0	A
	-5.0V		0		-5.0	A
Line Regulation	+5.0V	Input Voltage = Min to Max			±0.2	%
	-5.0V	Output Current = Balanced Loads, Max			±0.5	%
Load Regulation	+5.0V	Input Voltage = Nom, Current = Min to Max			±0.5	%
	-5.0V	Please see regulation curves on p.9			±2.0	%
Ripple & Noise	+5.0V	Ripple		16	25	mVp-p
		Spike (20MHz B.W.)		22	30	mVp-p
	-5.0V	Ripple		50	70	mVp-p
		Spike (20MHz B.W.)		55	75	mVp-p
Transient Response (75% - 100% step Load)	+5.0V	Peak Deviation		±60	±80	mV
		Settling Time		100	120	µSec
Over Voltage Protection	+5.0V	FeedBack Loop Voltag Clamp		+6.5		VDC
Short Circuit Protection		Hiccup Mode Indefinite, Automic Recovery				
Start-Up		Resistive Load		1.0	1.5	mSec

<sup>1</sup>(+5V min. load required for (-)5V regulation, please see regulation curves on page 9.

### Output Ripple & Noise

(Measured with no external capacitor, 20MHz B.W.)

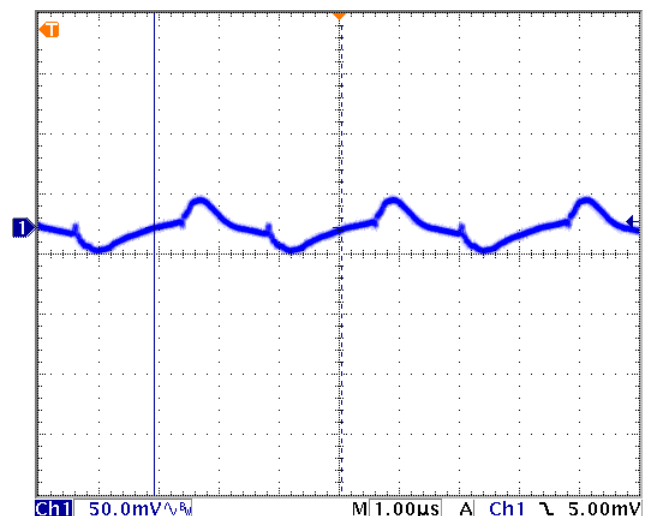
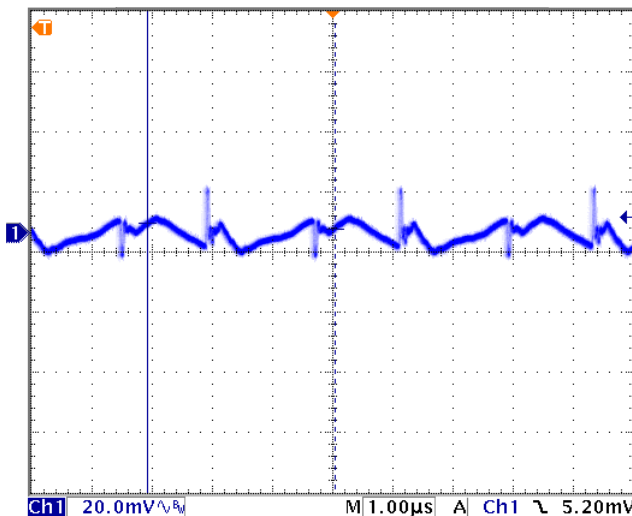

**Output Load Transient**  
(75% to 100% Step Load change)

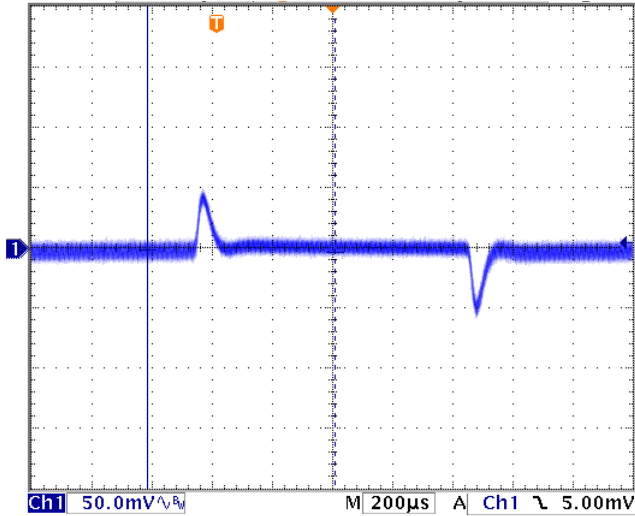

+5.0V

**Start-Up**  
(Resistive, Full Load)

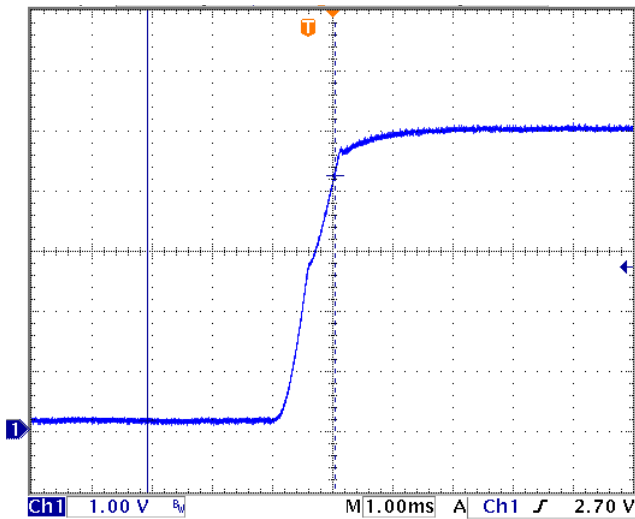

+5.0V

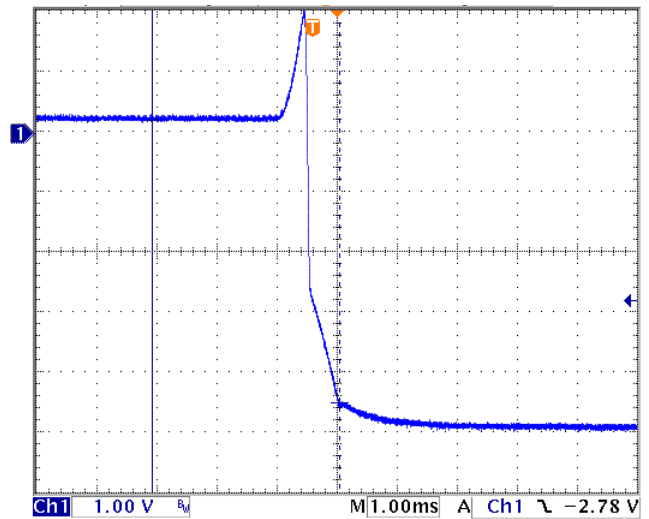

-5.0V



### Efficiency Curves

(Measured @ Baseplate Temp < 50°C)

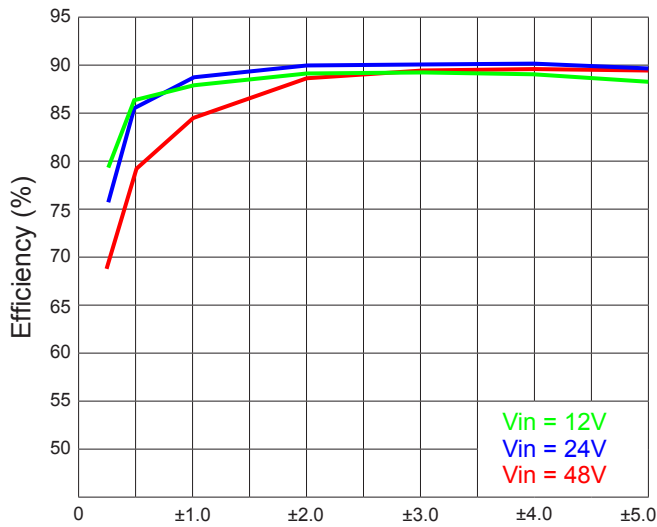

Load Current (A)

### Cross Regulation

(±15V Unbalanced Loads)

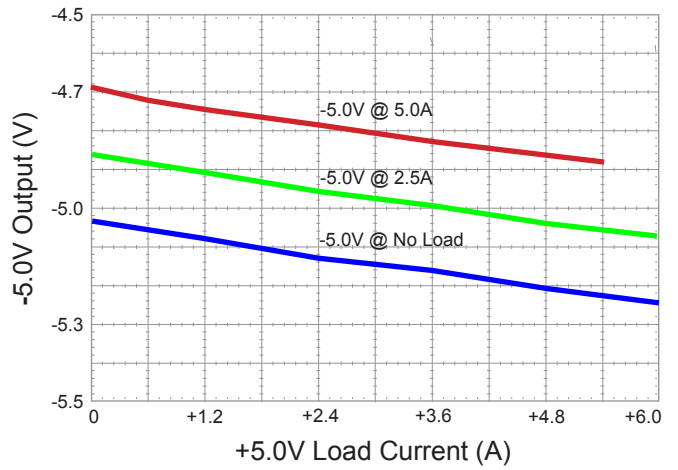

-5.0V Regulation Curves

### OUTPUT SPECIFICATIONS:

All specifications apply over specified input voltage, output load, and temperature range, unless otherwise noted.

Parameter		Condition/Description	Min	Nom	Max	Unit
Output Voltage	+10V	Input Voltage = Nom	+9.90	+10.0	+10.10	VDC
	-10V	Output Current = Balanced Loads, Max	-9.80	-10.0	-10.20	VDC
Output Current <sup>3</sup>	+10V	Baseplate Temperature =< +90°C	0 <sup>1</sup>	+1.25	+2.0	A
	-10V		0	-1.25	-1.25	A
Line Regulation	+10V	Input Voltage = Min to Max			±0.2	%
	-10V	Output Current = Balanced Loads, Max			±0.5	%
Load Regulation	+10V	Input Voltage = Nom, Current = Min to Max			±0.5	%
	-10V	Please see regulation curves on p.12			±2.0	%
Ripple & Noise	+10V	Ripple		16	25	mVp-p
		Spike (20MHz B.W.)		22	30	mVp-p
	-10V	Ripple		18	25	mVp-p
		Spike (20MHz B.W.)		18	30	mVp-p
Transient Response (75% -100% step Load)	+10V	Peak Deviation		±60	±80	mV
		Settling Time		100	120	µSec
Over Voltage Protection	+10V	FeedBack Loop Voltag Clamp		+13		VDC
Short Circuit Protection		Hiccup Mode Indefinite, Automic Recovery				
Start-Up		Resistive Load		1.0	1.5	mSec

<sup>1</sup>(+10V min. load required for (-)10V regulation, please see regulation curves on page 12.

### Output Ripple & Noise

(Measured with no external capacitor, 20MHz B.W.)

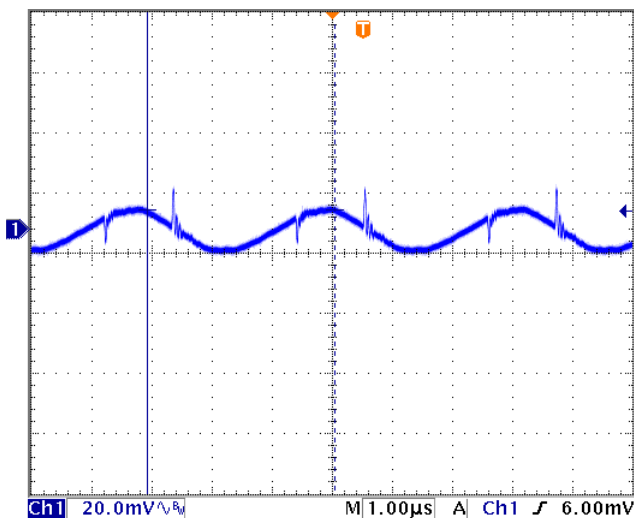

+10V

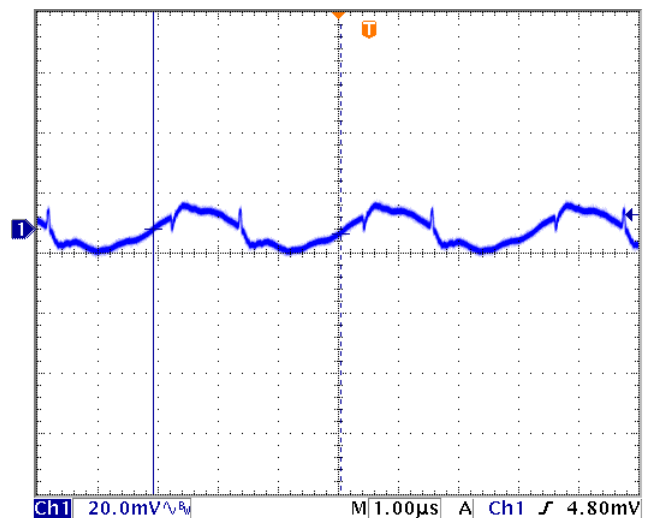

-10V

**Output Load Transient**  
(75% to 100% Step Load change)

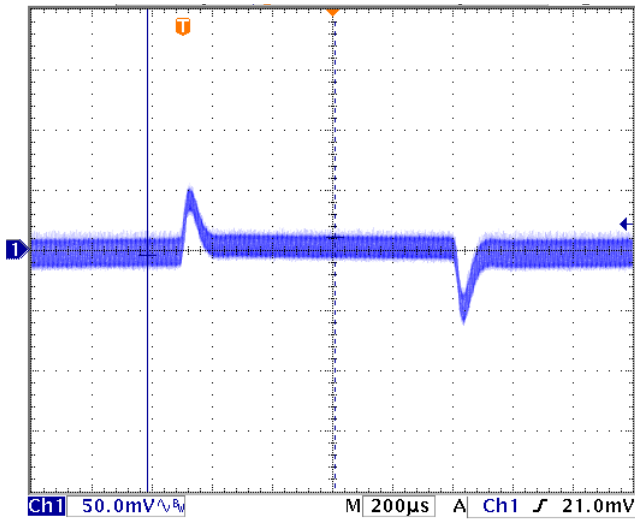

+10V

**Start-Up**  
(Resistive, Full Load)

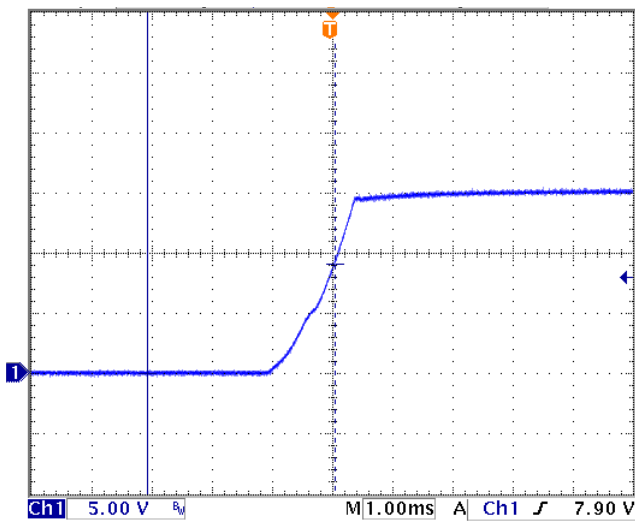

+10V

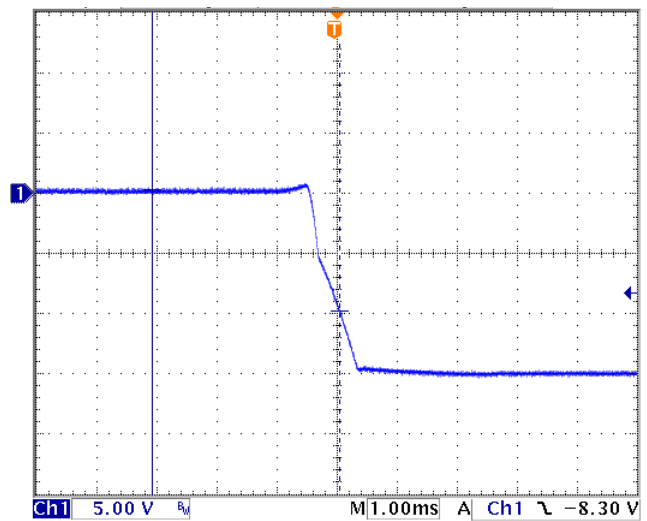

-10V

**Efficiency Curves**

(Measured @ Baseplate Temp < 50°C)

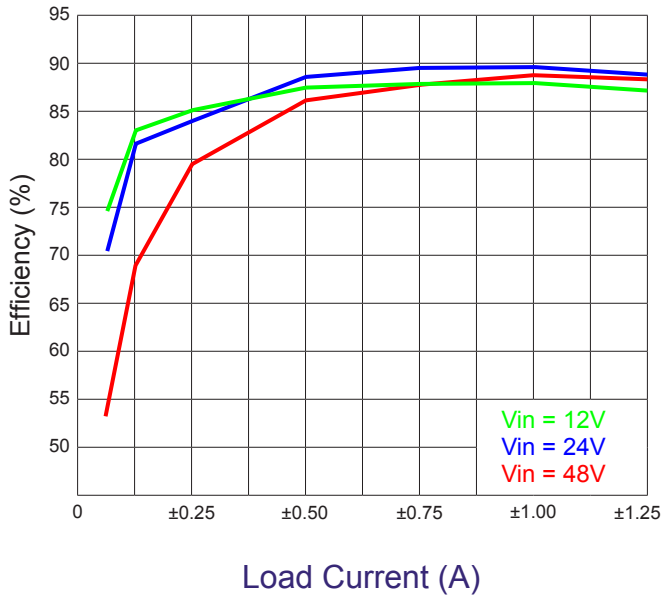

**Cross Regulation**

(±10V Unbalanced Loads)

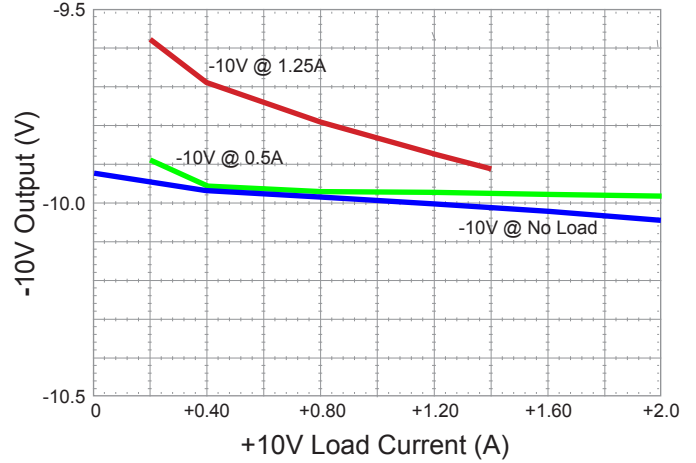

-10V Regulation Curves

### OUTPUT SPECIFICATIONS:

All specifications apply over specified input voltage, output load, and temperature range, unless otherwise noted.

Parameter		Condition/Description	Min	Nom	Max	Unit
Output Voltage	+10V	Input Voltage = Nom	+9.90	+10.0	+10.10	VDC
	-10V	Output Current = Balanced Loads, Max	-9.80	-10.0	-10.20	VDC
Output Current	+10V	Baseplate Temperature =< +90°C	0 <sup>1</sup>	+2.5	+3.5	A
	-10V		0	-2.5	-2.5	A
Line Regulation	+10V	Input Voltage = Min to Max			±0.2	%
	-10V	Output Current = Balanced Loads, Max			±0.5	%
Load Regulation	+10V	Input Voltage = Nom, Current = Min to Max			±0.5	%
	-10V	Please see regulation curves on p.15			±2.0	%
Ripple & Noise	+10V	Ripple		30	55	mVp-p
		Spike (20MHz B.W.)		40	60	mVp-p
	-10V	Ripple		40	55	mVp-p
		Spike (20MHz B.W.)		40	60	mVp-p
Transient Response (75% -100% step Load)	+10V	Peak Deviation		±140	±160	mV
		Settling Time		100	120	µSec
Over Voltage Protection	+10V	FeedBack Loop Voltag Clamp		+13		VDC
Short Circuit Protection		Hiccup Mode Indefinite, Automic Recovery				
Start-Up		Resistive Load		1.0	1.5	mSec

<sup>1</sup>(+10V min. load required for (-)10V regulation, please see regulation curves on page 15.

### Output Ripple & Noise

(Measured with no external capacitor, 20MHz B.W.)

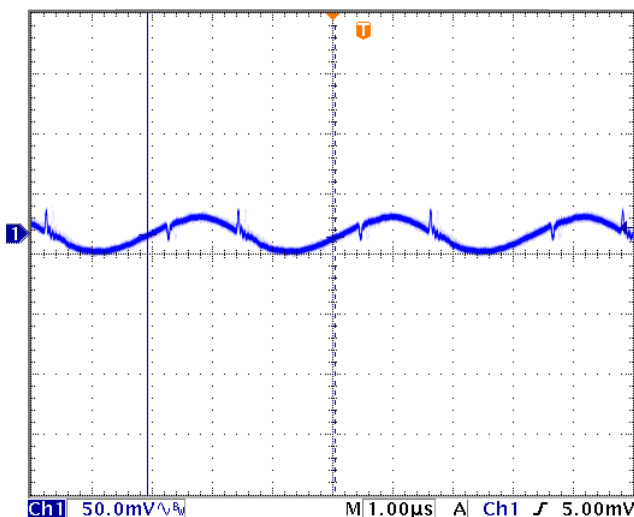

+10V

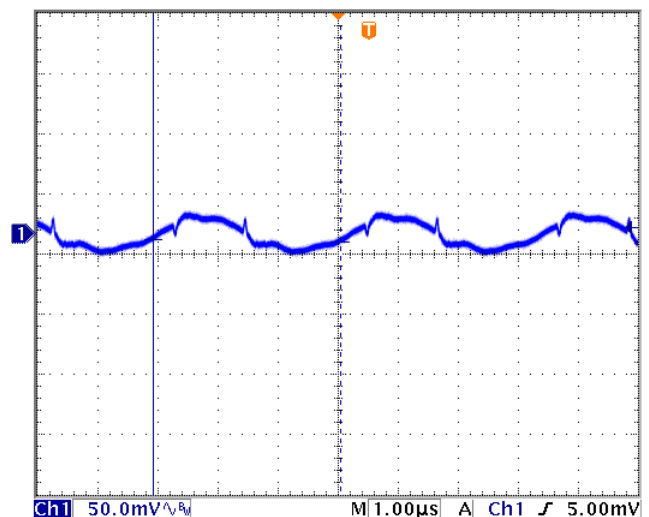

-10V

### Output Load Transient

(75% to 100% Step Load change)

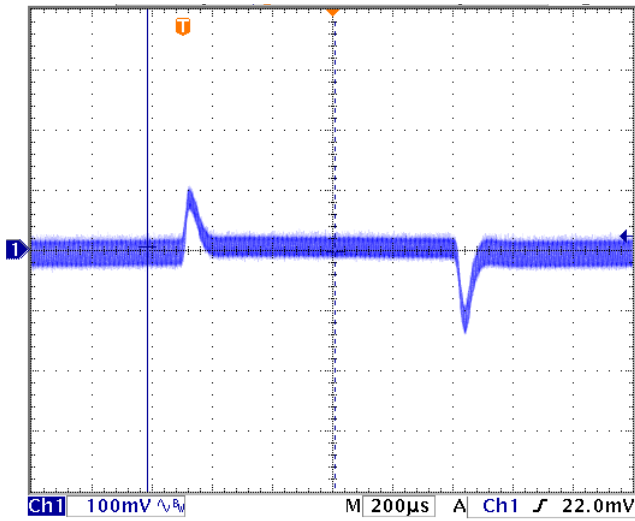

+10V

### Start-Up

(Resistive, Full Load)

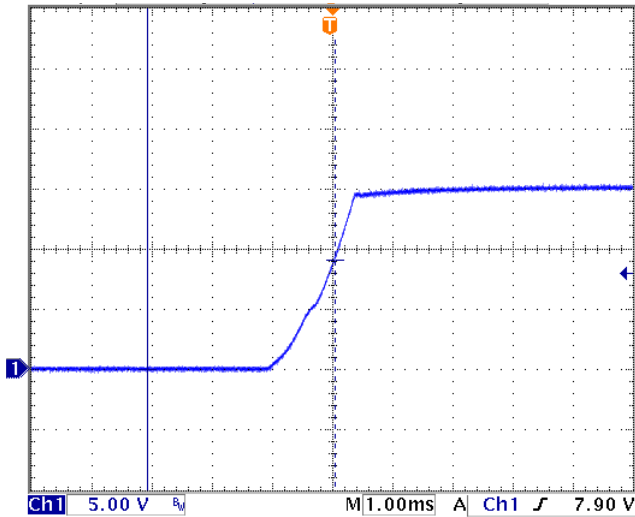

+10V

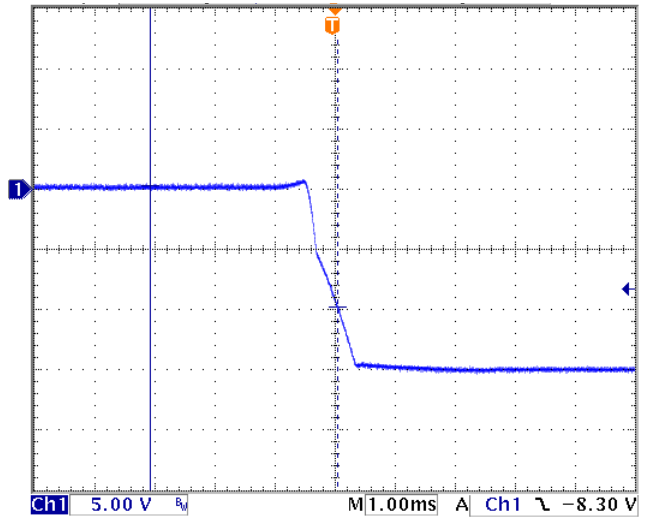

-10V

### Efficiency Curves

(Measured @ Baseplate Temp < 50°C)

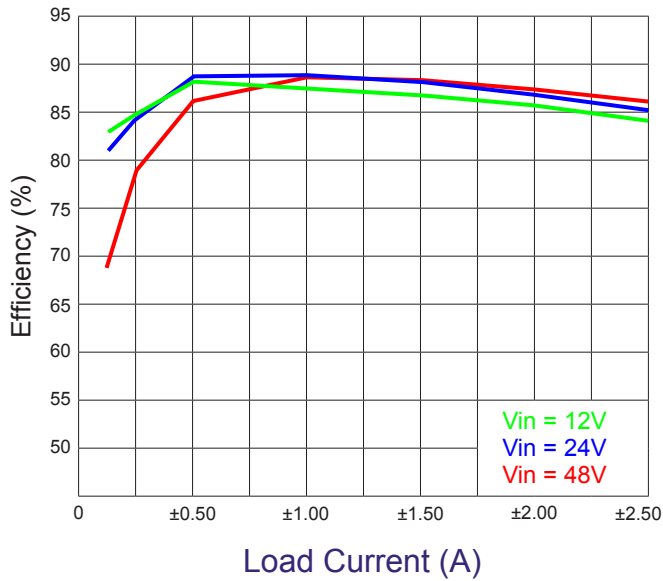

### Cross Regulation

(±10V Unbalanced Loads)

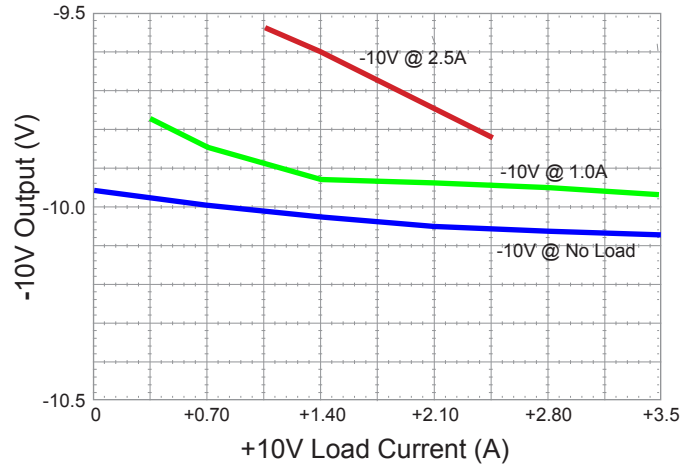

-10V Regulation Curves

### OUTPUT SPECIFICATIONS:

All specifications apply over specified input voltage, output load, and temperature range, unless otherwise noted.

Parameter		Condition/Description	Min	Nom	Max	Unit
Output Voltage	+12V	Input Voltage = Nom	+11.88	+12.0	+12.12	VDC
	-12V	Output Current = Balanced Loads, Max	-11.76	-12.0	-12.24	VDC
Output Current	+12V	Baseplate Temperature =< +90°C	0 <sup>1</sup>		+1.5	A
	-12V		0		-1.25	A
Line Regulation	+12V	Input Voltage = Min to Max			±0.2	%
	-12V	Output Current = Balanced Loads, Max			±0.5	%
Load Regulation	+12V	Input Voltage = Nom, Current = Min to Max			±0.5	%
	-12V	Please see regulation curves on p.18			±2.0	%
Ripple & Noise	+12V	Ripple		18	25	mVp-p
		Spike (20MHz B.W.)		22	30	mVp-p
	-12V	Ripple		18	25	mVp-p
		Spike (20MHz B.W.)		20	30	mVp-p
Transient Response (75% - 100% step Load)	+12V	Peak Deviation		±55	±70	mV
		Settling Time		100	120	µSec
Over Voltage Protection	+12V	FeedBack Loop Voltag Clamp		+15		VDC
Short Circuit Protection		Hiccup Mode Indefinite, Automic Recovery				
Start-Up		Resistive Load		1.0	1.5	mSec

<sup>1</sup>(+12V min. load required for (-)12V regulation, please see regulation curves on page 18.

### Output Ripple & Noise

(Measured with no external capacitor, 20MHz B.W.)

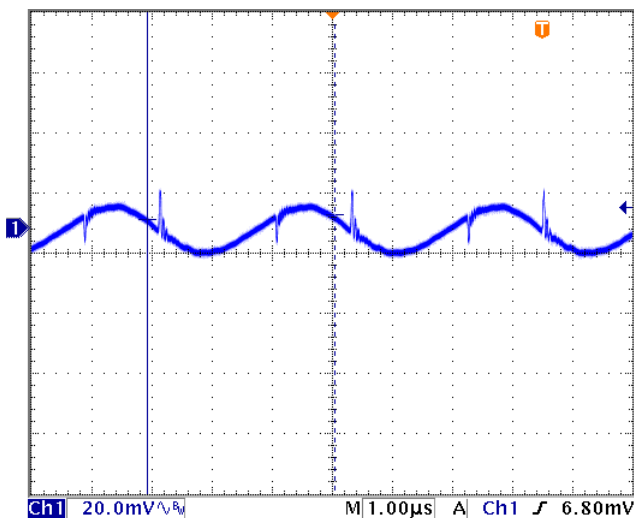

+12V

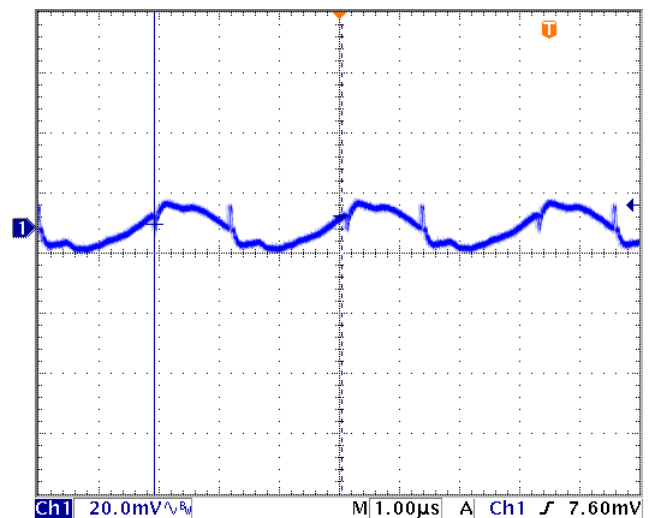

-12V



### Output Load Transient

(75% to 100% Step Load change)

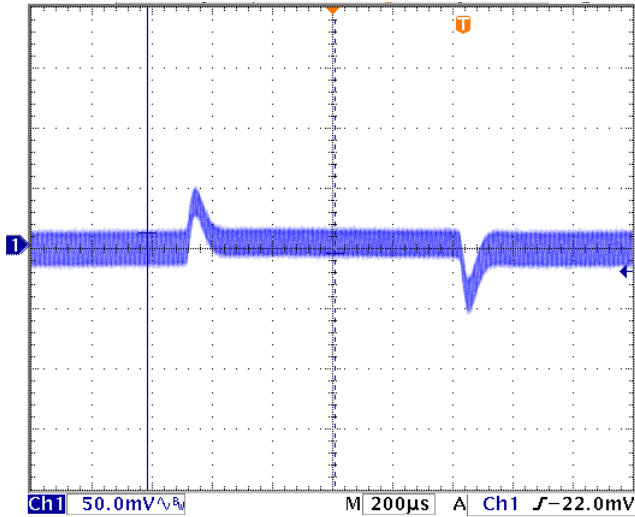

+12V

### Start-Up

(Resistive, Full Load)

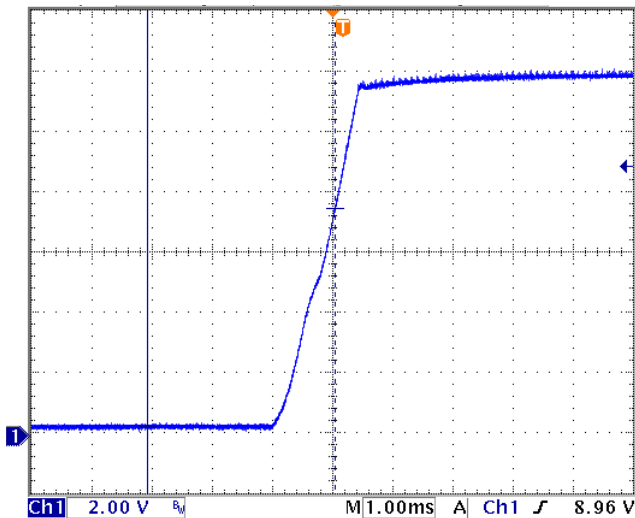

+12V

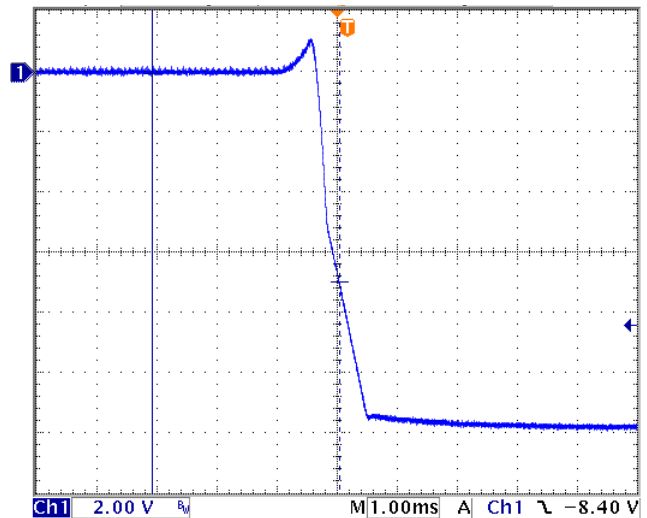

-12V

### Efficiency Curves

(Measured @ Baseplate Temp < 50°C)

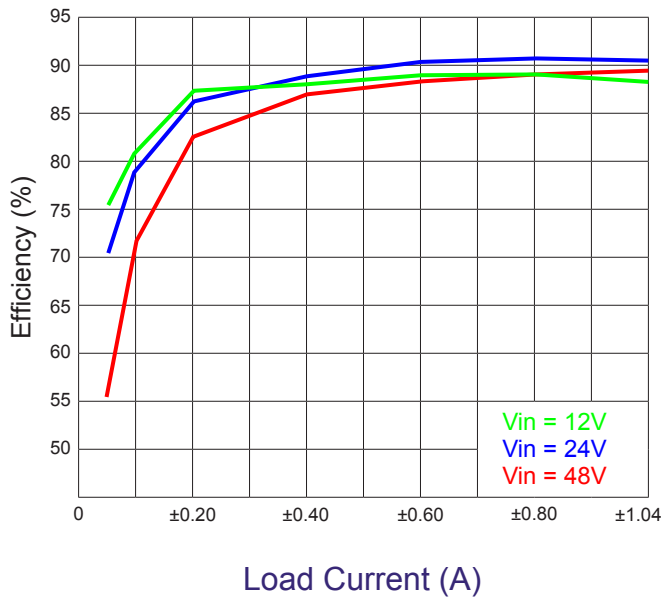

### Cross Regulation

(±12V Unbalanced Loads)

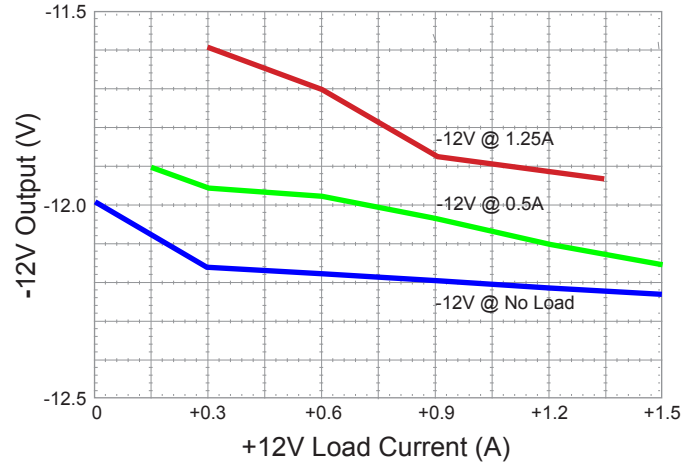

-12V Regulation Curves

### OUTPUT SPECIFICATIONS:

All specifications apply over specified input voltage, output load, and temperature range, unless otherwise noted.

Parameter		Condition/Description	Min	Nom	Max	Unit
Output Voltage	+12V	Input Voltage = Nom	+11.88	+12.0	+12.12	VDC
	-12V	Output Current = Balanced Loads, Max	-11.76	-12.0	-12.24	VDC
Output Current	+12V	Baseplate Temperature =< +90°C	0 <sup>1</sup>		+3.0	A
	-12V		0		-2.5	A
Line Regulation	+12V	Input Voltage = Min to Max			±0.2	%
	-12V	Output Current = Balanced Loads, Max			±0.5	%
Load Regulation	+12V	Input Voltage = Nom, Current = Min to Max			±0.5	%
	-12V	Please see regulation curves on p.21			±2.0	%
Ripple & Noise	+12V	Ripple		40	60	mVp-p
		Spike (20MHz B.W.)		45	65	mVp-p
	-12V	Ripple		40	60	mVp-p
		Spike (20MHz B.W.)		45	65	mVp-p
Transient Response (75% -100% step Load)	+12V	Peak Deviation		±120	±150	mV
		Settling Time		100	120	µSec
Over Voltage Protection	+12V	FeedBack Loop Voltag Clamp		+15		VDC
Short Circuit Protection		Hiccup Mode Indefinite, Automic Recovery				
Start-Up		Resistive Load		1.0	1.5	mSec

<sup>1</sup>(+12V min. load required for (-)12V regulation, please see regulation curves on page 21.

### Output Ripple & Noise

(Measured with no external capacitor, 20MHz B.W.)

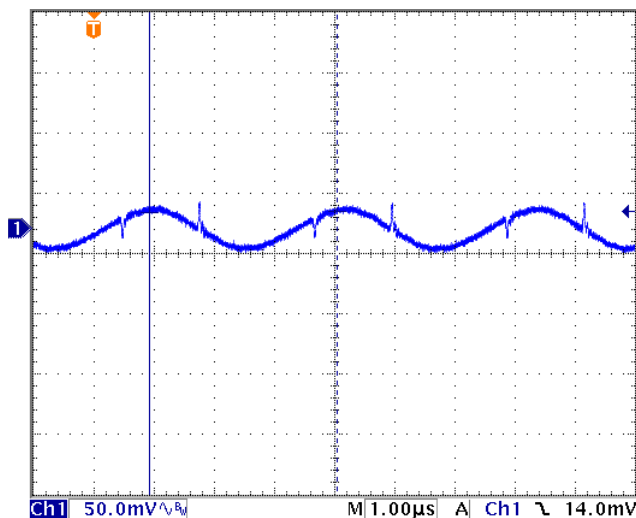

+12V

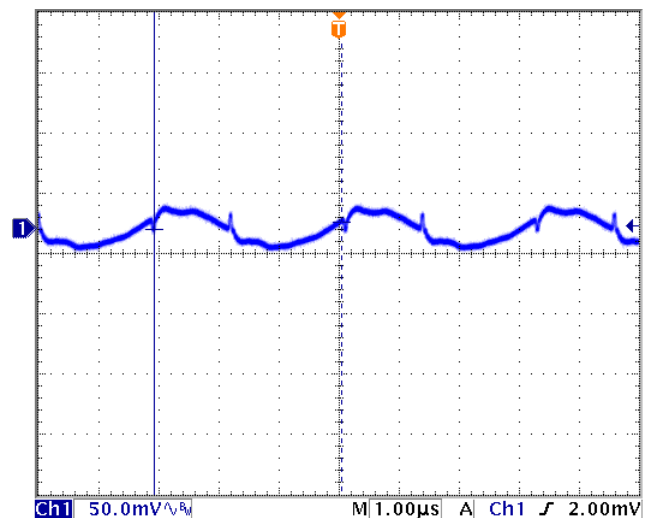

-12V

### Output Load Transient (75% to 100% Step Load change)

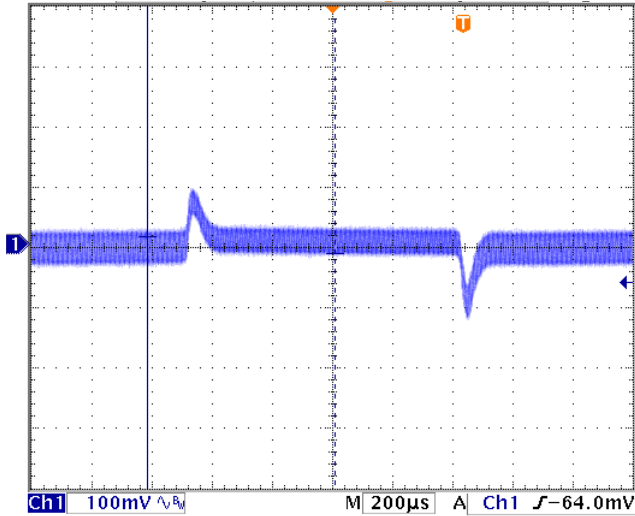

+12V

### Start-Up (Resistive, Full Load)

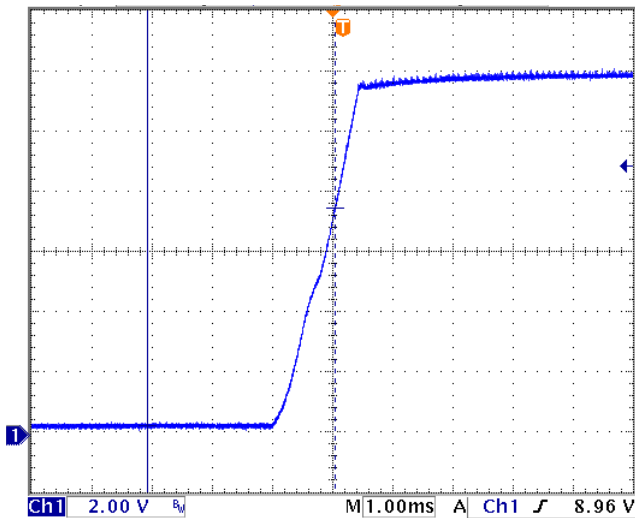

+12V

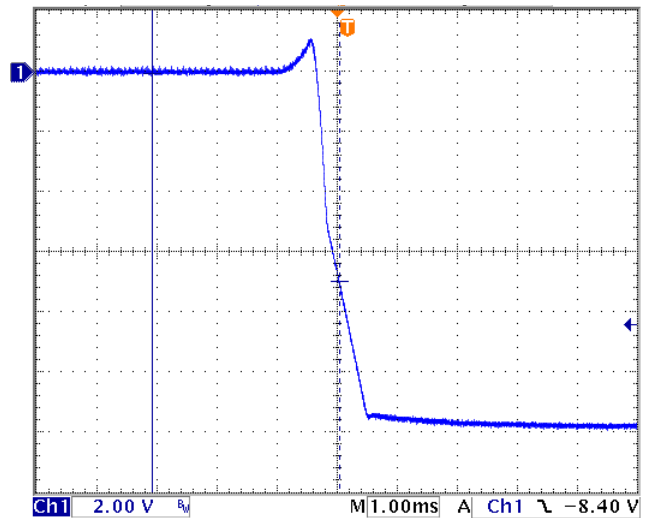

-12V

**Efficiency Curves**

(Measured @ Baseplate Temp < 50°C)

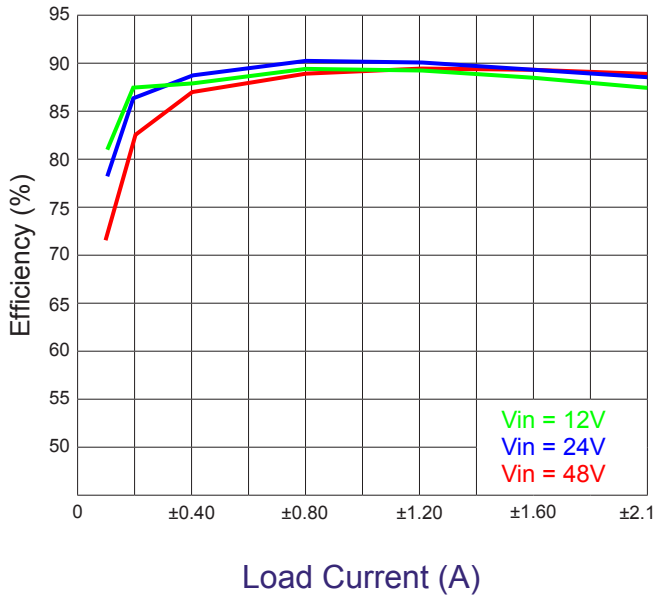

**Cross Regulation**

(±12V Unbalanced Loads)

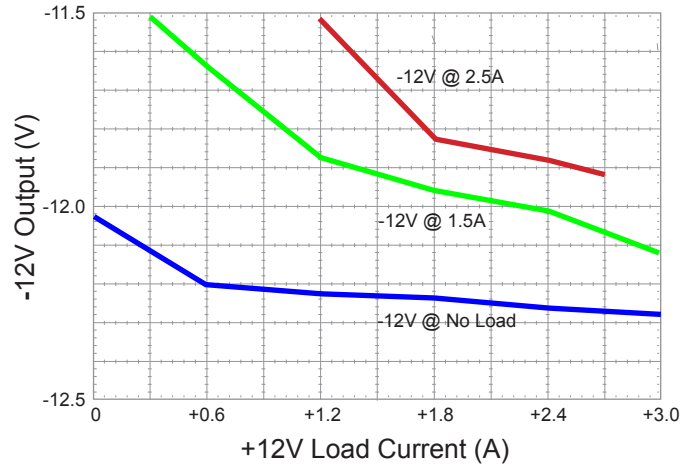

-12V Regulation Curves

### OUTPUT SPECIFICATIONS:

All specifications apply over specified input voltage, output load, and temperature range, unless otherwise noted.

Parameter		Condition/Description	Min	Nom	Max	Unit
Output Voltage	+15V	Input Voltage = Nom	+14.85	+15.0	+15.15	VDC
	-15V	Output Current = Balanced Loads, Max	-14.70	-15.0	-15.30	VDC
Output Current	+15V	Baseplate Temperature =< +90°C	0 <sup>1</sup>		+1.2	A
	-15V		0		-1.0	A
Line Regulation	+15V	Input Voltage = Min to Max			±0.2	%
	-15V	Output Current = Balanced Loads, Max			±0.5	%
Load Regulation	+15V	Input Voltage = Nom, Current = Min to Max			±0.5	%
	-15V	Please see regulation curves on p.24			±2.0	%
Ripple & Noise	+15V	Ripple		25	35	mVp-p
		Spike (20MHz B.W.)		35	50	mVp-p
	-15V	Ripple		5	10	mVp-p
		Spike (20MHz B.W.)		15	25	mVp-p
Transient Response (75% -100% step Load)	+15V	Peak Deviation		±50	±70	mV
		Settling Time		100	120	µSec
Over Voltage Protection	+15V	FeedBack Loop Voltag Clamp		+19		VDC
Short Circuit Protection		Hiccup Mode Indefinite, Automic Recovery				
Start-Up		Resistive Load		1.5	2.0	mSec

<sup>1</sup>(+15V min. load required for (-)15V regulation, please see regulation curves on page 24.

### Output Ripple & Noise

(Measured with no external capacitor, 20MHz B.W.)

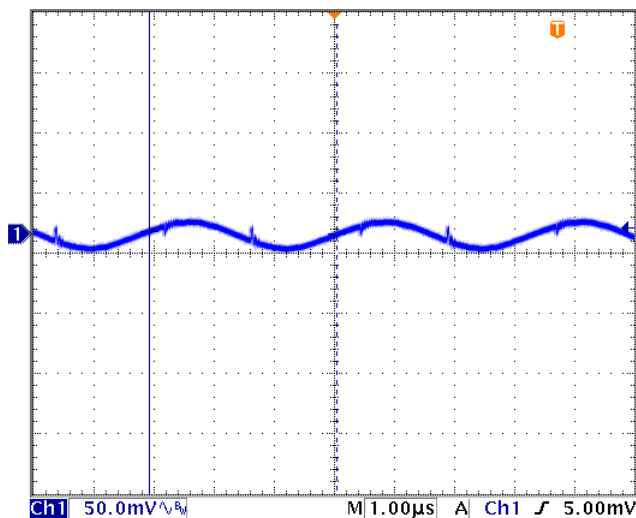

+15V

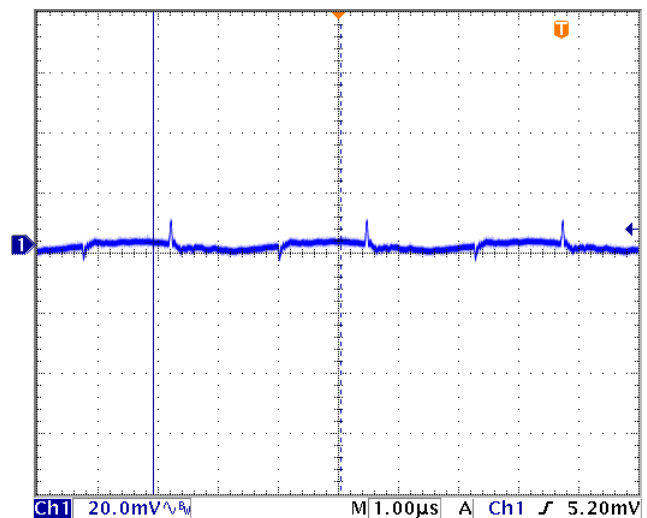

-15V

### Output Load Transient (75% to 100% Step Load change)

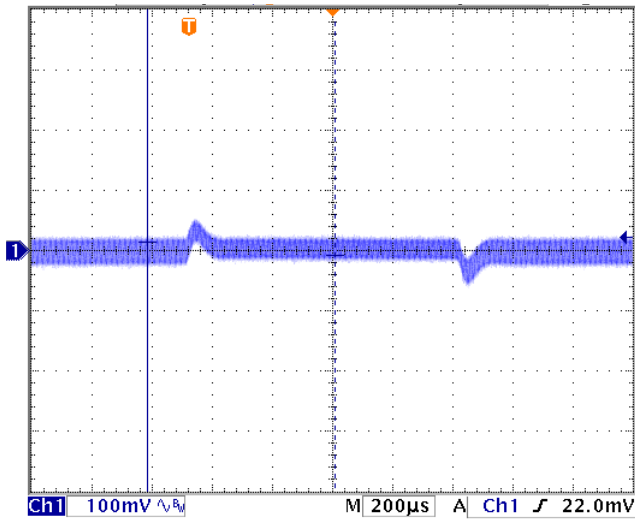

+15V

### Start-Up (Resistive, Full Load)

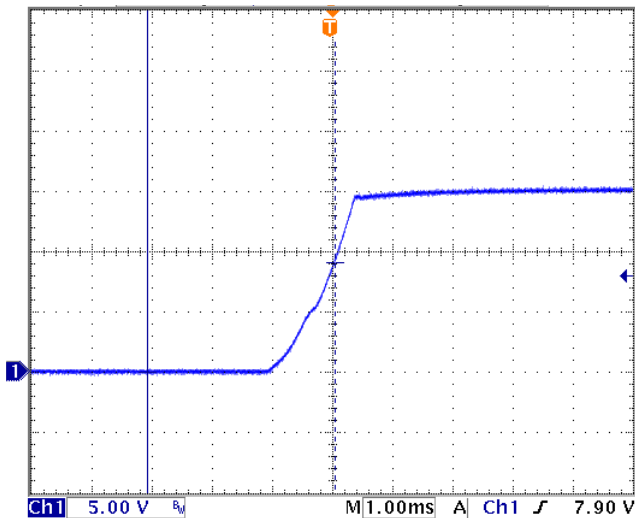

+15V

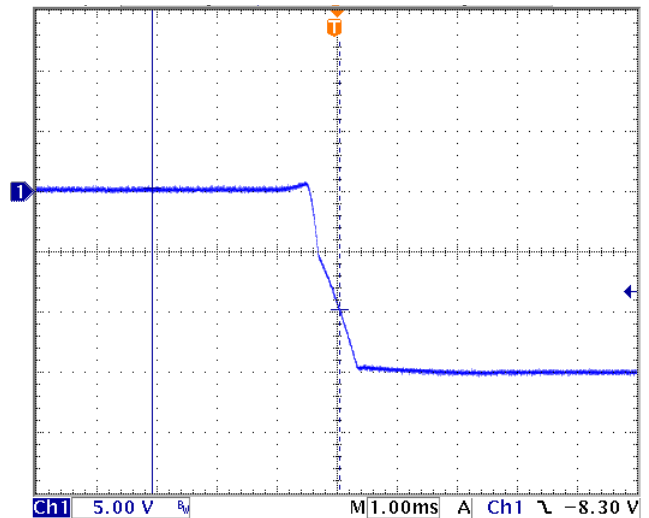

-15V

### Efficiency Curves

(Measured @ Baseplate Temp < 50°C)

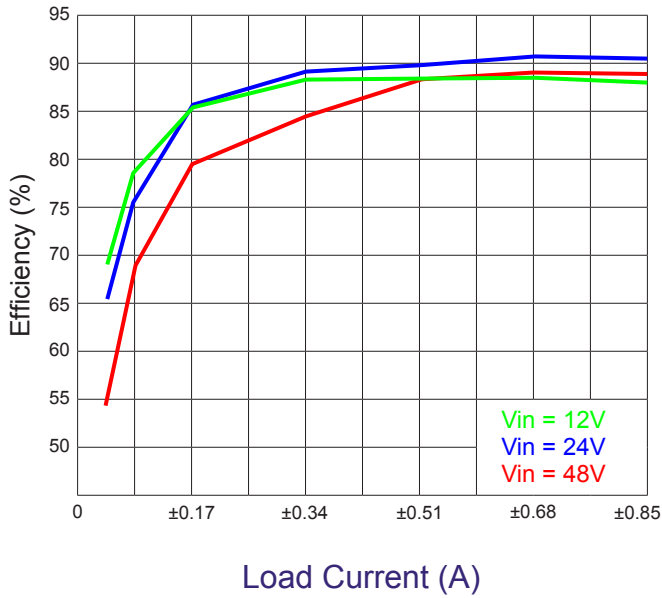

### Cross Regulation

( $\pm 15V$  Unbalanced Loads)

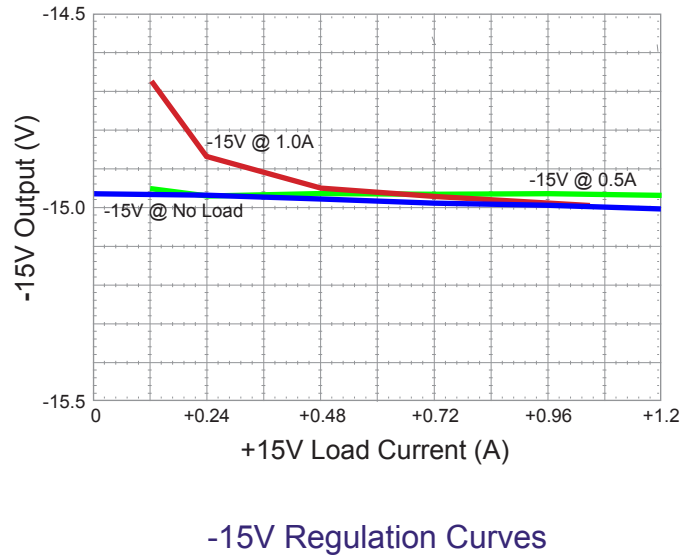



### OUTPUT SPECIFICATIONS:

All specifications apply over specified input voltage, output load, and temperature range, unless otherwise noted.

Parameter		Condition/Description	Min	Nom	Max	Unit
Output Voltage	+15V	Input Voltage = Nom	+14.85	+15.0	+15.15	VDC
	-15V	Output Current = Balanced Loads, Max	-14.70	-15.0	-15.30	VDC
Output Current	+15V	Baseplate Temperature =< +90°C	0 <sup>1</sup>		+2.4	A
	-15V		0		-2.0	A
Line Regulation	+15V	Input Voltage = Min to Max			±0.2	%
	-15V	Output Current = Balanced Loads, Max			±0.5	%
Load Regulation	+15V	Input Voltage = Nom, Current = Min to Max			±0.5	%
	-15V	Please see regulation curves on p.27			±2.0	%
Ripple & Noise	+15V	Ripple		50	70	mVp-p
		Spike (20MHz B.W.)		60	80	mVp-p
	-15V	Ripple		16	30	mVp-p
		Spike (20MHz B.W.)		20	35	mVp-p
Transient Response (75% -100% step Load)	+15V	Peak Deviation		±120	±150	mV
		Settling Time		100	120	µSec
Over Voltage Protection	+15V	FeedBack Loop Voltag Clamp		+19		VDC
Short Circuit Protection		Hiccup Mode Indefinite, Automic Recovery				
Start-Up		Resistive Load		1.5	2.0	mSec

<sup>1</sup>(+15V min. load required for (-)15V regulation, please see regulation curves on page 27.

### Output Ripple & Noise

(Measured with no external capacitor, 20MHz B.W.)

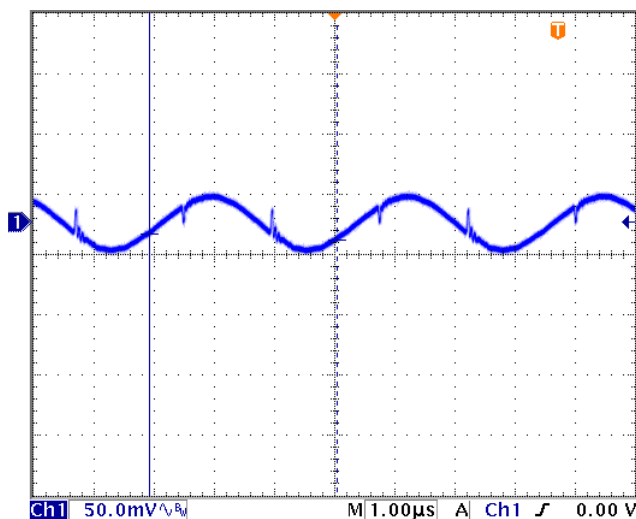

+15V

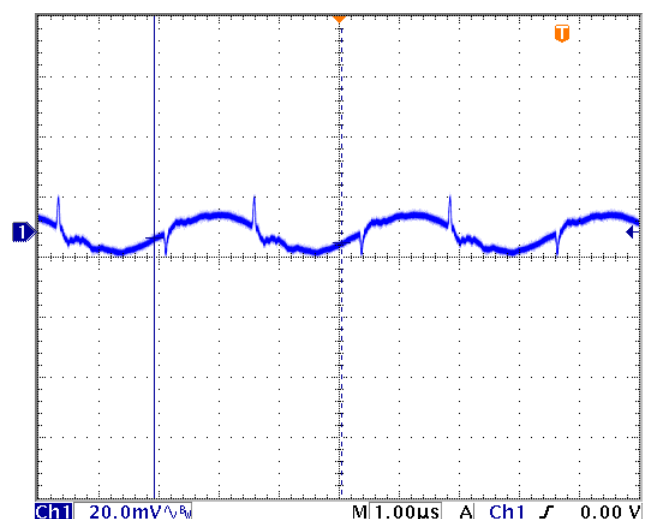

-15V

### Output Load Transient (75% to 100% Step Load change)

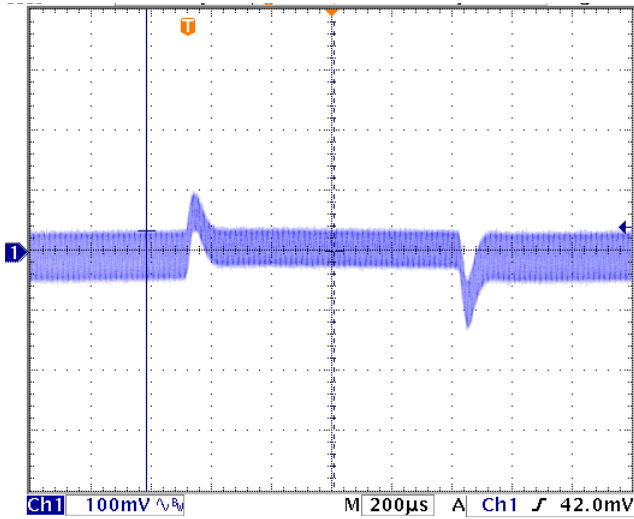

+15V

### Start-Up (Resistive, Full Load)

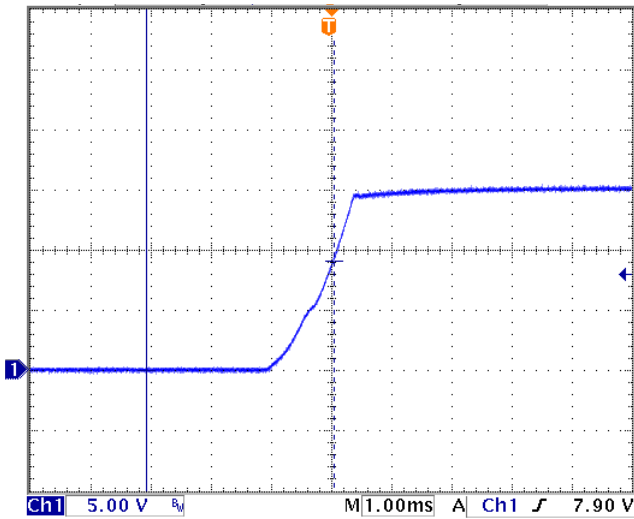

+15V

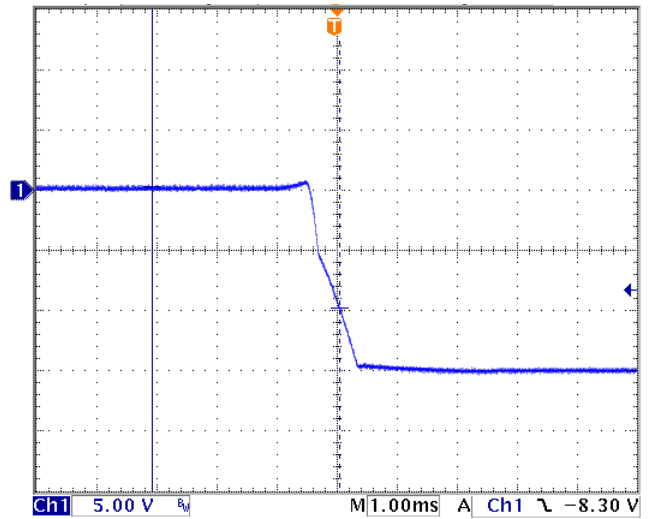

-15V

### Efficiency Curves

(Measured @ Baseplate Temp < 50°C)

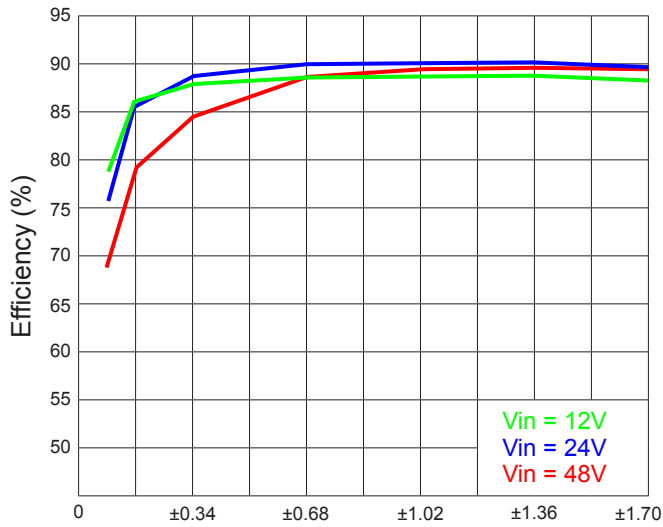

Load Current (A)

### Cross Regulation

( $\pm 15V$  Unbalanced Loads)

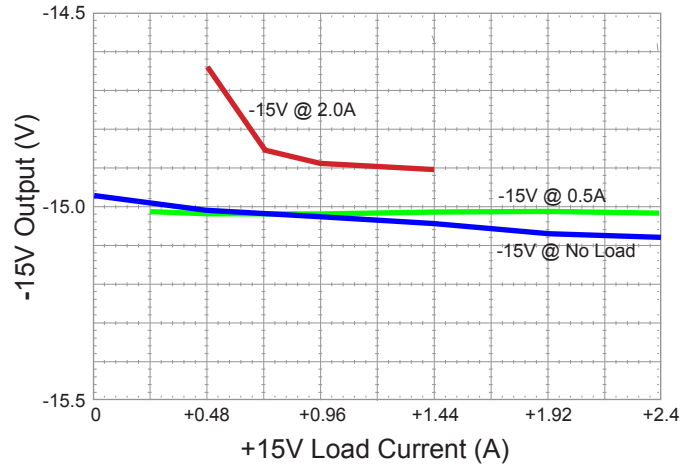

-15V Regulation Curves

### GENERAL SPECIFICATIONS:

All specifications apply over specified input voltage, output load, and temperature range, unless otherwise noted.

Parameter	Condition/Description	Min	Nom	Max	Unit
Operating Frequency	Fixed		300		KHz
Isolation Voltage	Input to Output	1500			VDC
	Metal Case to Input/Output	500			VDC
Isolation Resistance	Input to Output	10			MΩ
Isolation Capacitance	Input to Output		2200		pF
MTBF	Bellcore TR_NWT-000332		1,500		KHrs

<sup>1</sup> Input Voltage.

<sup>2</sup> Output Current.

### ENVIRONMENTAL SPECIFICATIONS:

All specifications apply over specified input voltage, output load, and temperature range, unless otherwise noted.

Parameter	Condition/Description	Min	Nom	Max	Unit
Temperature Coefficient	-55°C to +100°C Baseplate Temp.		0.02		%/°C
Operating Baseplate Temperature Range	Standard	-40		+85	°C
	Extended	-55		+100	°C
Storage Temperature Range		-55		+125	°C
Thermal Impedance	Per Watt Dissipation <sup>1</sup>			20	°C/W
Over Temperature Protection	Activated @ Baseplate Temperature		+105		°C
	Recovered @ Baseplate Temperature		+95		°C
Humidity	Relative Humidity, Non-Condensing	10		95	%
Shock	(Half-sinewave, 6ms), 3 axes	50			g
Vibration	GR-63-CORE, Section 5.4.2	1			g

<sup>1</sup> Not per Watt Output. Total Dissipation (W) = Total Output Power \* (1 / Efficiency - 1).

### MECHANICAL SPECIFICATIONS:

All specifications apply over specified input voltage, output load, and temperature range, unless otherwise noted.

Parameter	Condition/Description	Min	Nom	Max	Unit
Dimensions	Please see Drawing on p.30				
Weight	Open Frame		0.83 (24)		Oz (g)
	Encapsulated		2.50 (70)		Oz (g)

**OPTIONS:**

DESCRIPTION	OPTION (suffix)	NOTES
Extended Temperature	C	Operating Baseplate Temperature from -55°C to +100°C
Encapsulated	MC	Potted with Thermally Conductive RTV in a Metal Case

**Product Numbering System:**

DH	50	D	48	05	C, MC
Series	50W Output	Dual Output	36 - 75Vin	$\pm 5.0V_{out}$	Options

**Simplified Ripple & Noise Measurement**

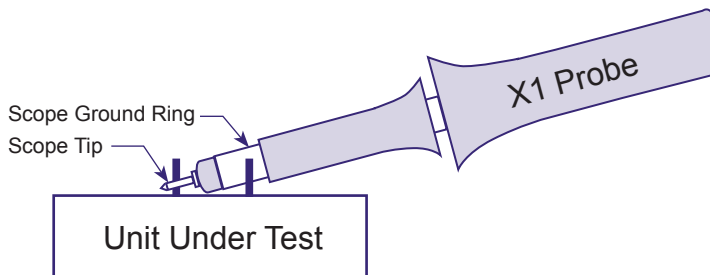

**Open Frame (Standard, No Suffix)**

**Encapsulated (Optional, Suffix MC)**

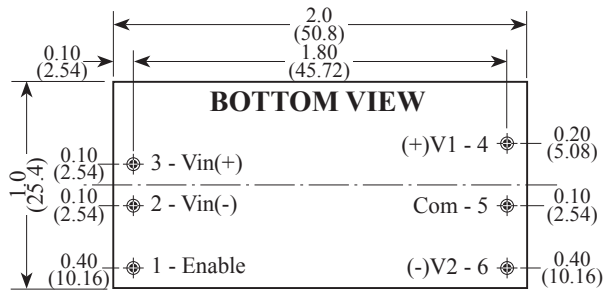

All pins are 0.040(1.00) dia. with  
standoff shoulder 0.065(1.65) dia.

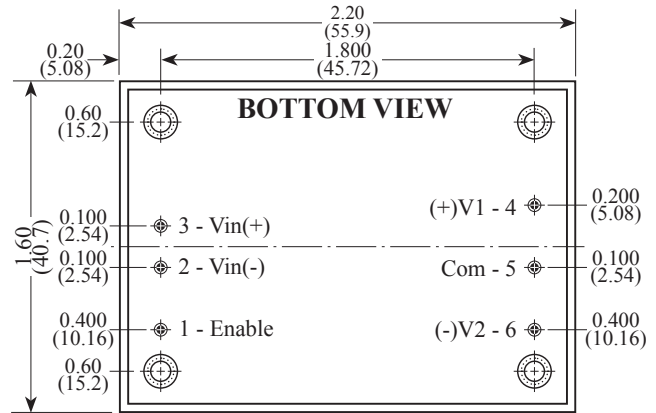
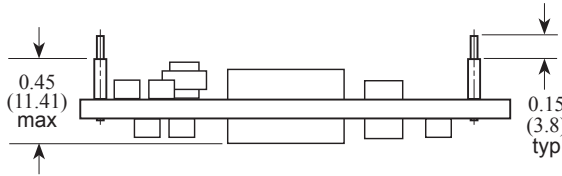

All pins are 0.040" (1.0mm) dia.

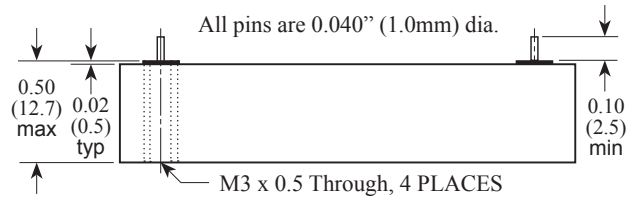

**ALL DIMENSION IN INCHES (mm)**

Tolerance .xx =  $\pm 0.05$   
.xxx =  $\pm 0.005$