



DIONICS, INC.

65 Rushmore Street
Westbury, NY 11590

Phone: (516) 997-7474

Fax: (516) 997-7479

Website: www.dionics-usa.com

LEVEL-SHIFTED GAS DISCHARGE DISPLAY DIGIT DRIVERS

DI-505B

DI-510B

General Description:

The DIONICS DI-505B and DI-510B series circuits are designed for interfacing between MOS or TTL circuitry and gas discharge display panels. Each section of these devices is made up of a switched constant current level shifter-capable of high voltage operation and a PNP-NPN driver transistor pair. The constant current operation of the level shifter stage results in low power dissipation. Input circuitry is suitable for open drain PMOS, CMOS, open-collector or standard TTL.

Features:

- ✓ 200V Level Shift Capability
- ✓ MOS and TTL Compatibility
- ✓ 6- and 8-line Versions
- ✓ Low Power Dissipation
- ✓ Reliable Dielectric Isolation Process

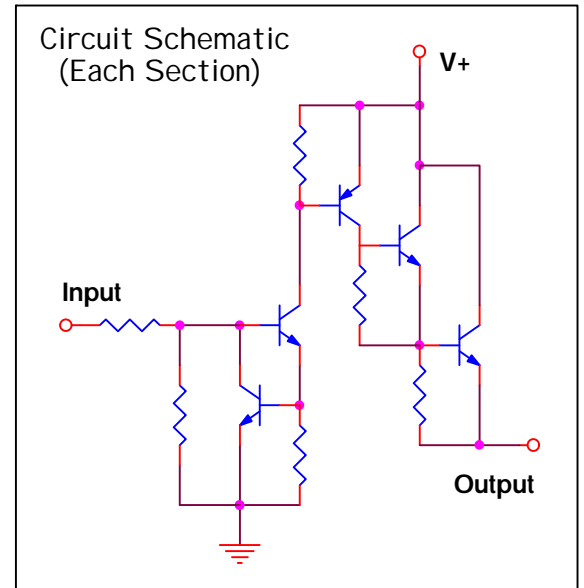

Package Layout:

DI-505B

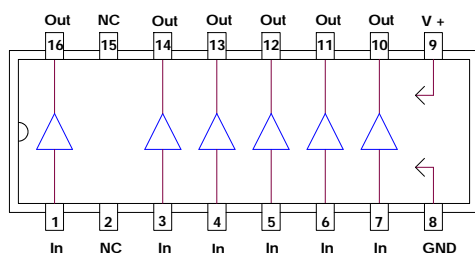
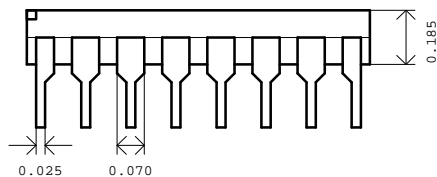
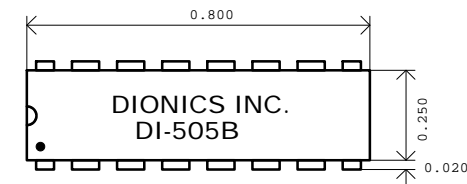

DI-510B

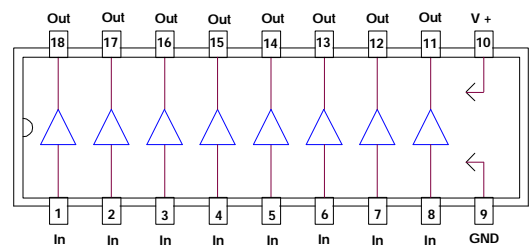
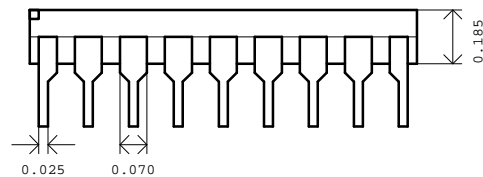
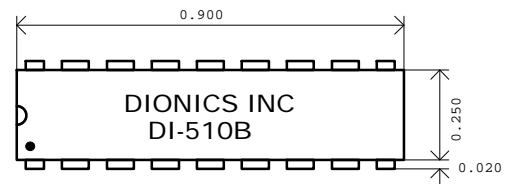

Absolute Maximum Rating ($T_a = 25^{\circ}\text{C}$)

Characteristic	Symbol	Notes	Limits	Units	
Supply Voltage	V_+	Measured With Respect to GND	200	V	
Input Voltage	V_{in}	Measured With Respect to GND	35	V	
Output Voltage	V_{out}	Measured With Respect to V_+ Terminal	90	V	
Output Current	I_{out}		40	mA	
Power Dissipation	DI-510B	P_D	Derate at $8\text{ mW}/^{\circ}\text{C}$ Above 25°C Ambient	800	mW
	DI-505B	P_D	Derate at $6\text{ mW}/^{\circ}\text{C}$ Above 25°C Ambient	600	mW
Storage Temperature	T_s		-55 to +125	$^{\circ}\text{C}$	
Operating Temperature	T_o		0 to +70	$^{\circ}\text{C}$	

Electrical Characteristics ($T_a = 25^{\circ}\text{C}$)

Parameter	Symbol	Notes	Conditions	Typ.	Max.	Units
Output Saturation Voltage	$V_{out}(\text{SAT})$	$V_+ = 180\text{V}$; Measured With Respect to V_+ Terminal	$I_o = 25\text{mA}$; $V_i = 2.4\text{V}$	3	10	V
Output Leakage Current	$I_{out}(\text{OFF})$	$V_+ = 180\text{V}$	$V_o = 90\text{V}$; $V_i = 0.4\text{V}$	0.1	10	μA
Input Current	$I_{in}(\text{ON})$		$V_i = 2.4\text{V}$	340	400	μA
Supply Current	I_+	One Input at 2.4V , Others at 0.4V	$V_+ = 180\text{V}$; $V_i = 2.4\text{V}$; $I_o = 0$	0.5	1.5	mA

Typical Application:

