

FEATURES

- Low $V_{CE(sat)}$ Device
- 10 μ s Short Circuit Withstand
- High Thermal Cycling Capability
- High Current Density Enhanced DMOS SPT
- High Current Density Enhanced DMOS SPT
- Isolated AISiC Base with AlN Substrates

APPLICATIONS

- Choppers
- Motor Controllers
- Power Supplies
- Traction Auxiliaries

The Powerline range of high power modules includes half bridge, chopper, dual, single and bi-directional switch configurations covering voltages from 1200V to 6500V and currents up to 2400A.

The DIM250PKM33-TL000 is a Low $V_{CE(sat)}$ 3300V, n-channel enhancement mode, insulated gate bipolar transistor (IGBT) chopper module configured with the upper arm of the bridge controlled. The IGBT has a wide reverse bias safe operating area (RBSOA). This device is optimised for traction drives and other applications requiring high thermal cycling capability.

The module incorporates an electrically isolated base plate and low inductance construction enabling circuit designers to optimise circuit layouts and utilise grounded heat sinks for safety.

ORDERING INFORMATION

Order As:

DIM250PKM33-TL000

Note: When ordering, please use the complete part number

KEY PARAMETERS

V_{CES}	3300V
$V_{CE(sat)}$ * (typ)	2.0V
I_C (max)	250A
$I_{C(PK)}$ (max)	500A

* Measured at the auxiliary terminals

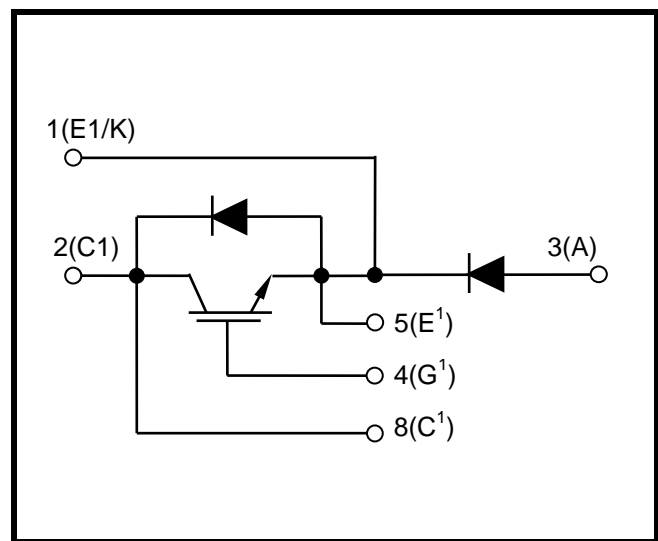
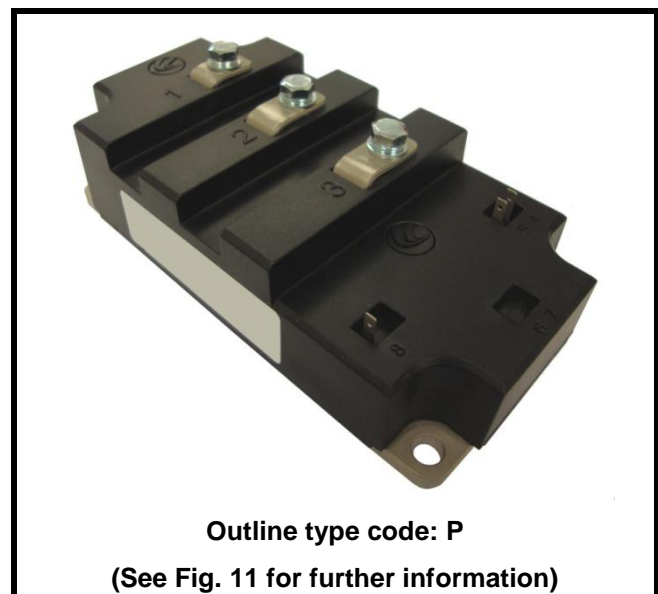

Fig. 1 Circuit configuration



Outline type code: P

(See Fig. 11 for further information)

Fig. 2 Package

ABSOLUTE MAXIMUM RATINGS

Stresses above those listed under 'Absolute Maximum Ratings' may cause permanent damage to the device. In extreme conditions, as with all semiconductors, this may include potentially hazardous rupture of the package. Appropriate safety precautions should always be followed. Exposure to Absolute Maximum Ratings may affect device reliability.

$T_{case} = 25^{\circ}\text{C}$ unless stated otherwise

Symbol	Parameter	Test Conditions	Max.	Units
V_{CES}	Collector-emitter voltage	$V_{GE} = 0\text{V}$	3300	V
V_{GES}	Gate-emitter voltage		± 20	V
I_C	Continuous collector current	$T_{case} = 115^{\circ}\text{C}$	250	A
$I_{C(PK)}$	Peak collector current	1ms, $T_{case} = 140^{\circ}\text{C}$	500	A
P_{max}	Max. transistor power dissipation	$T_{case} = 25^{\circ}\text{C}$, $T_j = 150^{\circ}\text{C}$	2.6	kW
I^2t	Diode I^2t value – IGBT Arm	$V_R = 0$, $t_p = 10\text{ms}$, $T_j = 150^{\circ}\text{C}$	20	kA^2s
	Diode I^2t value – Diode Arm		20	kA^2s
V_{isol}	Isolation voltage – per module	Commoned terminals to base plate. AC RMS, 1 min, 50Hz	6000	V
Q_{PD}	Partial discharge – per module	IEC1287, $V_1 = 3500\text{V}$, $V_2 = 2600\text{V}$, 50Hz RMS	10	pC

THERMAL AND MECHANICAL RATINGS

Internal insulation material:	AlN
Baseplate material:	AlSiC
Creepage distance:	33mm
Clearance:	20mm
CTI (Comparative Tracking Index):	>600

Symbol	Parameter	Test Conditions	Min	Typ.	Max	Units
$R_{th(j-c)}$	Thermal resistance – transistor	Continuous dissipation - junction to case	-	-	48	$^{\circ}\text{C}/\text{kW}$
$R_{th(j-c)}$	Thermal resistance – diode (IGBT Arm)	Continuous dissipation - junction to case	-	-	96	$^{\circ}\text{C}/\text{kW}$
	Thermal resistance – diode (Diode Arm)		-	-	96	$^{\circ}\text{C}/\text{kW}$
$R_{th(c-h)}$	Thermal resistance – case to heatsink (per module)	Mounting torque 5Nm (with mounting grease)	-	-	16	$^{\circ}\text{C}/\text{kW}$
T_j	Junction temperature	Transistor	-	-	150	$^{\circ}\text{C}$
		Diode	-	-	150	$^{\circ}\text{C}$
T_{stg}	Storage temperature range	-	-40	-	125	$^{\circ}\text{C}$
	Screw torque	Mounting – M6	-	-	5	Nm
		Electrical connections – M5	-	-	4	Nm

ELECTRICAL CHARACTERISTICS
 $T_{case} = 25^{\circ}\text{C}$ unless stated otherwise.

Symbol	Parameter	Test Conditions	Min	Typ	Max	Units
I_{CES}	Collector cut-off current	$V_{GE} = 0\text{V}, V_{CE} = V_{CES}$			1	mA
		$V_{GE} = 0\text{V}, V_{CE} = V_{CES}, T_{case} = 125^{\circ}\text{C}$			15	mA
		$V_{GE} = 0\text{V}, V_{CE} = V_{CES}, T_{case} = 150^{\circ}\text{C}$			25	mA
I_{GES}	Gate leakage current	$V_{GE} = \pm 20\text{V}, V_{CE} = 0\text{V}$			1	μA
$V_{GE(TH)}$	Gate threshold voltage	$I_C = 20\text{mA}, V_{GE} = V_{CE}$		5.7		V
$V_{CE(sat)}^{\dagger}$	Collector-emitter saturation voltage	$V_{GE} = 15\text{V}, I_C = 250\text{A}$		2.0		V
		$V_{GE} = 15\text{V}, I_C = 250\text{A}, T_j = 125^{\circ}\text{C}$		2.6		V
		$V_{GE} = 15\text{V}, I_C = 250\text{A}, T_j = 150^{\circ}\text{C}$		2.8		V
I_F	Diode forward current	DC		250		A
I_{FM}	Diode maximum forward current	$t_p = 1\text{ms}$		500		A
V_F	Diode forward voltage † (IGBT arm)	$I_F = 250\text{A}$		2.4		V
	Diode forward voltage ‡ (Diode arm)			2.5		V
	Diode forward voltage † (IGBT arm)	$I_F = 250\text{A}, T_j = 125^{\circ}\text{C}$		2.5		V
	Diode forward voltage ‡ (Diode arm)			2.6		V
	Diode forward voltage † (IGBT arm)	$I_F = 250\text{A}, T_j = 150^{\circ}\text{C}$		2.4		V
	Diode forward voltage ‡ (Diode arm)			2.5		V
C_{ies}	Input capacitance	$V_{CE} = 25\text{V}, V_{GE} = 0\text{V}, f = 1\text{MHz}$		45		nF
Q_g	Gate charge	$\pm 15\text{V}$ Including external C_{ge}		5		μC
C_{res}	Reverse transfer capacitance	$V_{CE} = 25\text{V}, V_{GE} = 0\text{V}, f = 1\text{MHz}$		1		nF
L_M	Module inductance			40		nH
R_{INT}	Internal transistor resistance			500		$\mu\Omega$
SC_{Data}	Short circuit current, I_{SC}	$T_j = 150^{\circ}\text{C}, V_{CC} = 2500\text{V}$ $t_p \leq 10\mu\text{s}, V_{GE} \leq 15\text{V}$ $V_{CE(max)} = V_{CES} - L^* \times dl/dt$ IEC 60747-9		950		A

Note:
 † Measured at the auxiliary terminals

 ‡ Measured at the power busbars

 * L is the circuit inductance + L_M

ELECTRICAL CHARACTERISTICS

$T_{case} = 25^{\circ}\text{C}$ unless stated otherwise

Symbol	Parameter	Test Conditions	Min	Typ.	Max	Units	
$t_{d(off)}$	Turn-off delay time	$I_C = 250\text{A}$ $V_{GE} = \pm 15\text{V}$ $V_{CE} = 1800\text{V}$ $R_{g(ON)} = 10\Omega$ $R_{g(OFF)} = 10\Omega$ $C_{GE} = 56\text{nF}$ $L_S \sim 150\text{nH}$		2700		ns	
t_f	Fall time			610		ns	
E_{OFF}	Turn-off energy loss				650		mJ
$t_{d(on)}$	Turn-on delay time				960		ns
t_r	Rise time				430		ns
E_{ON}	Turn-on energy loss				400		mJ
Q_{rr}	Diode reverse recovery charge	$I_F = 250\text{A}$ $V_{CE} = 1800\text{V}$ $di_F/dt = 700\text{A}/\mu\text{s}$		140		μC	
I_{rr}	Diode reverse recovery current			150		A	
E_{rec}	Diode reverse recovery energy				170		mJ

$T_{case} = 125^{\circ}\text{C}$ unless stated otherwise

Symbol	Parameter	Test Conditions	Min	Typ.	Max	Units	
$t_{d(off)}$	Turn-off delay time	$I_C = 250\text{A}$ $V_{GE} = \pm 15\text{V}$ $V_{CE} = 1800\text{V}$ $R_{g(ON)} = 10\Omega$ $R_{g(OFF)} = 10\Omega$ $C_{GE} = 56\text{nF}$ $L_S \sim 150\text{nH}$		2750		ns	
t_f	Fall time			590		ns	
E_{OFF}	Turn-off energy loss				680		mJ
$t_{d(on)}$	Turn-on delay time				1000		ns
t_r	Rise time				460		ns
E_{ON}	Turn-on energy loss				520		mJ
Q_{rr}	Diode reverse recovery charge	$I_F = 250\text{A}$ $V_{CE} = 1800\text{V}$ $di_F/dt = 700\text{A}/\mu\text{s}$		230		μC	
I_{rr}	Diode reverse recovery current			190		A	
E_{rec}	Diode reverse recovery energy				280		mJ

$T_{case} = 150^{\circ}\text{C}$ unless stated otherwise

Symbol	Parameter	Test Conditions	Min	Typ.	Max	Units	
$t_{d(off)}$	Turn-off delay time	$I_C = 250\text{A}$ $V_{GE} = \pm 15\text{V}$ $V_{CE} = 1800\text{V}$ $R_{g(ON)} = 10\Omega$ $R_{g(OFF)} = 10\Omega$ $C_{GE} = 56\text{nF}$ $L_S \sim 150\text{nH}$		2760		ns	
t_f	Fall time			590		ns	
E_{OFF}	Turn-off energy loss				750		mJ
$t_{d(on)}$	Turn-on delay time				940		ns
t_r	Rise time				460		ns
E_{ON}	Turn-on energy loss				550		mJ
Q_{rr}	Diode reverse recovery charge	$I_F = 250\text{A}$ $V_{CE} = 1800\text{V}$ $di_F/dt = 700\text{A}/\mu\text{s}$		270		μC	
I_{rr}	Diode reverse recovery current			200		A	
E_{rec}	Diode reverse recovery energy				330		mJ

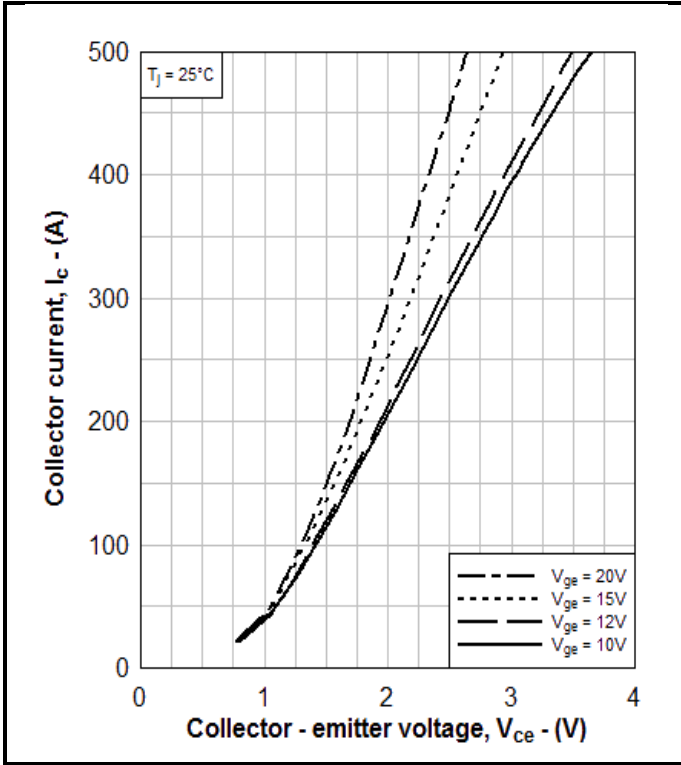

Fig. 3 Typical output characteristics

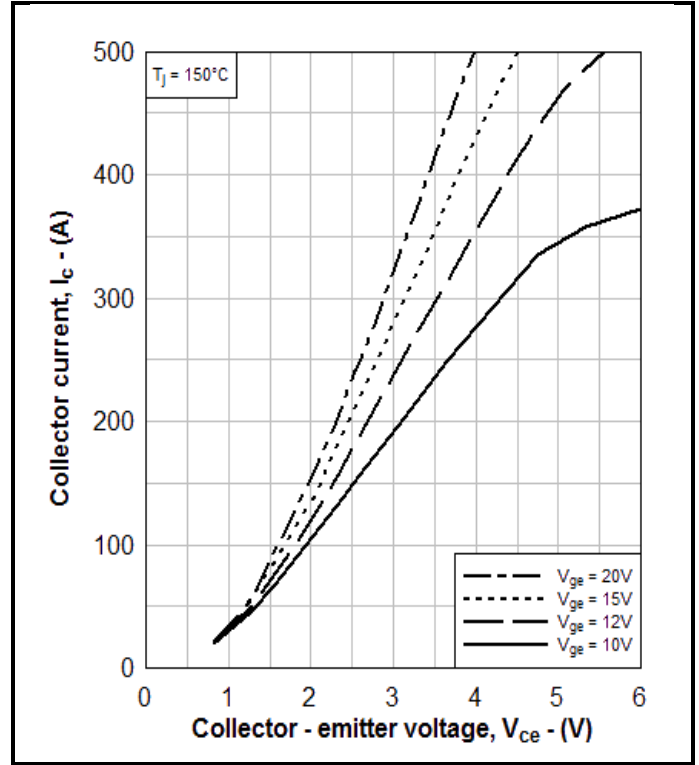

Fig. 4 Typical output characteristics

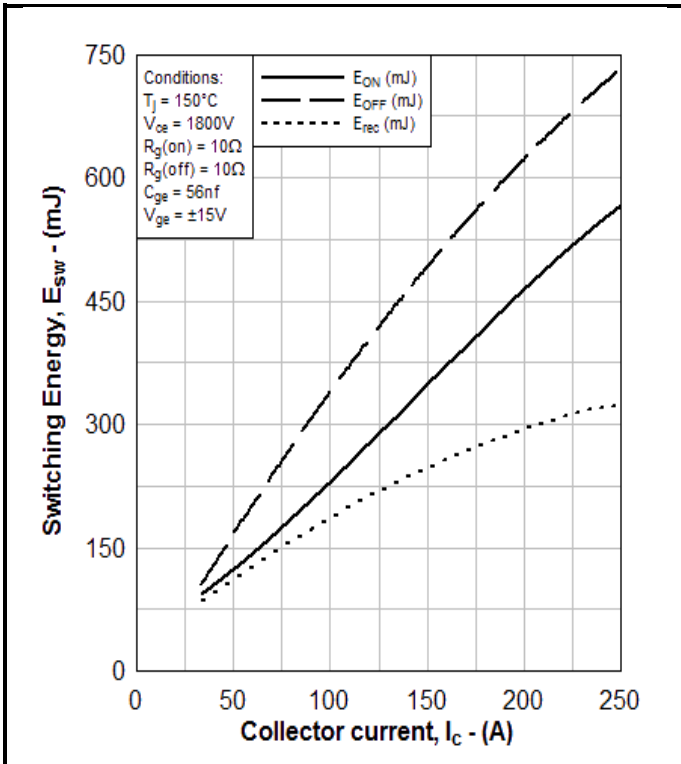

Fig. 5 Typical switching energy vs collector current

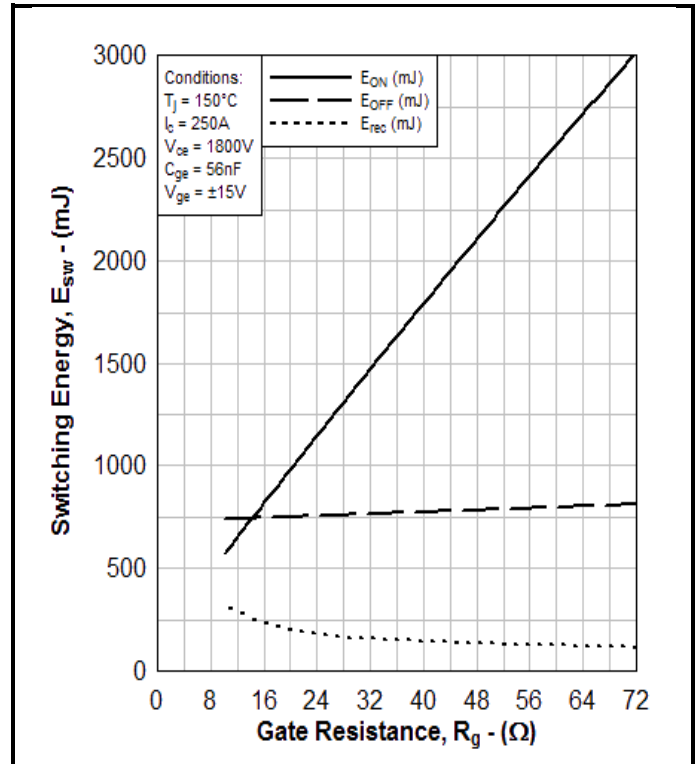

Fig. 6 Typical switching energy vs gate resistance

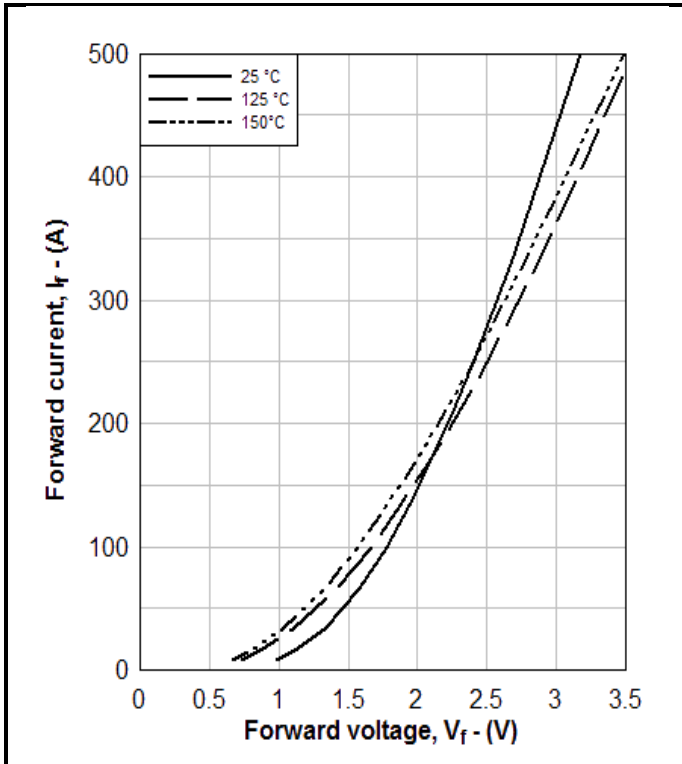

Fig. 7 Diode typical forward characteristics

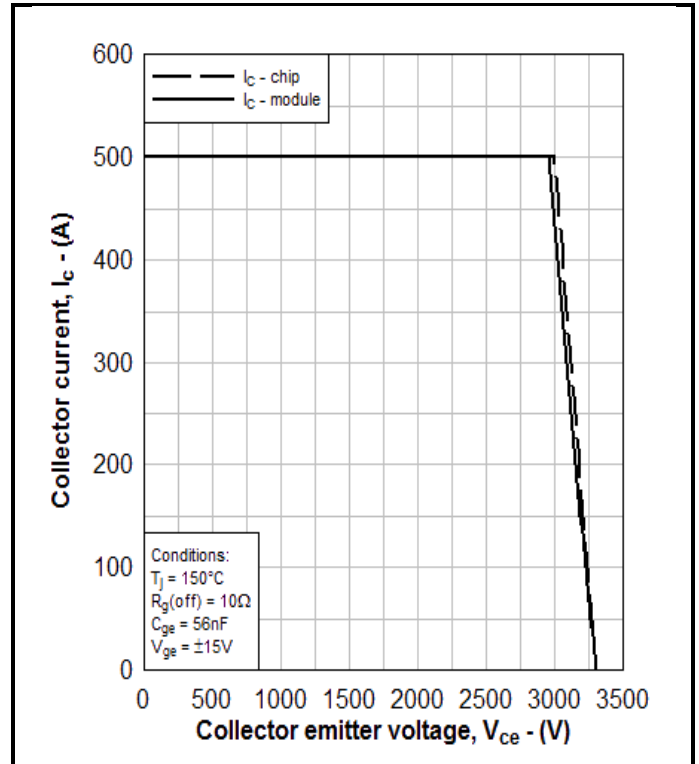

Fig. 8 Reverse bias safe operating area

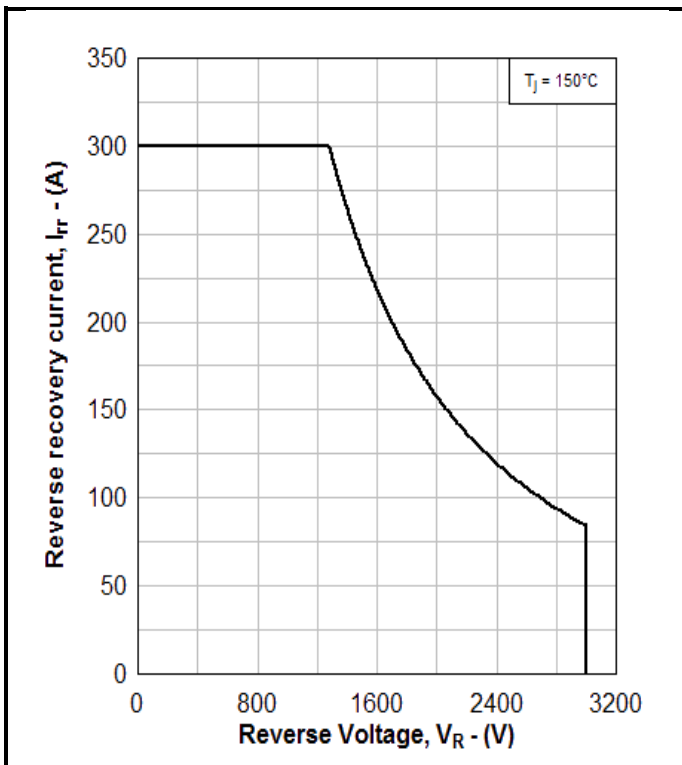

Fig. 9 Diode reverse bias safe operating area

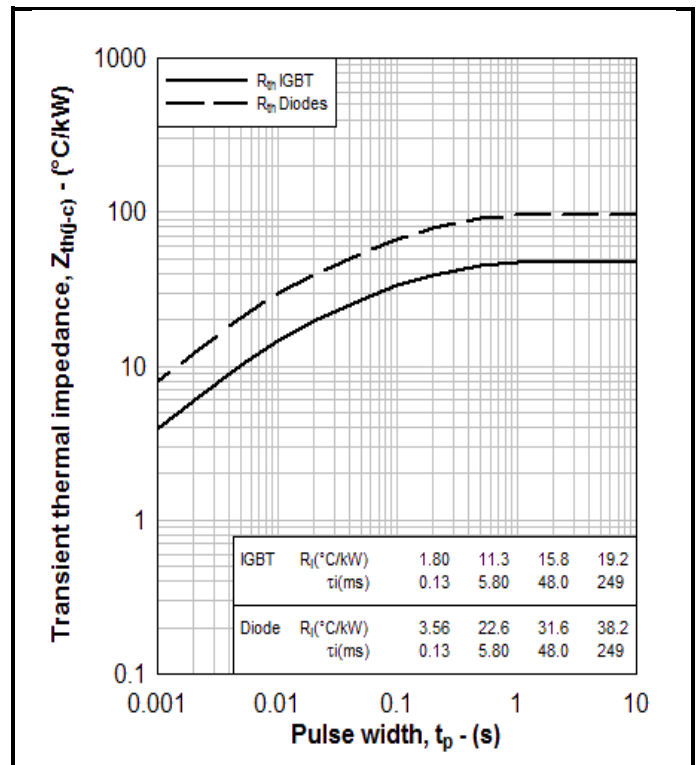
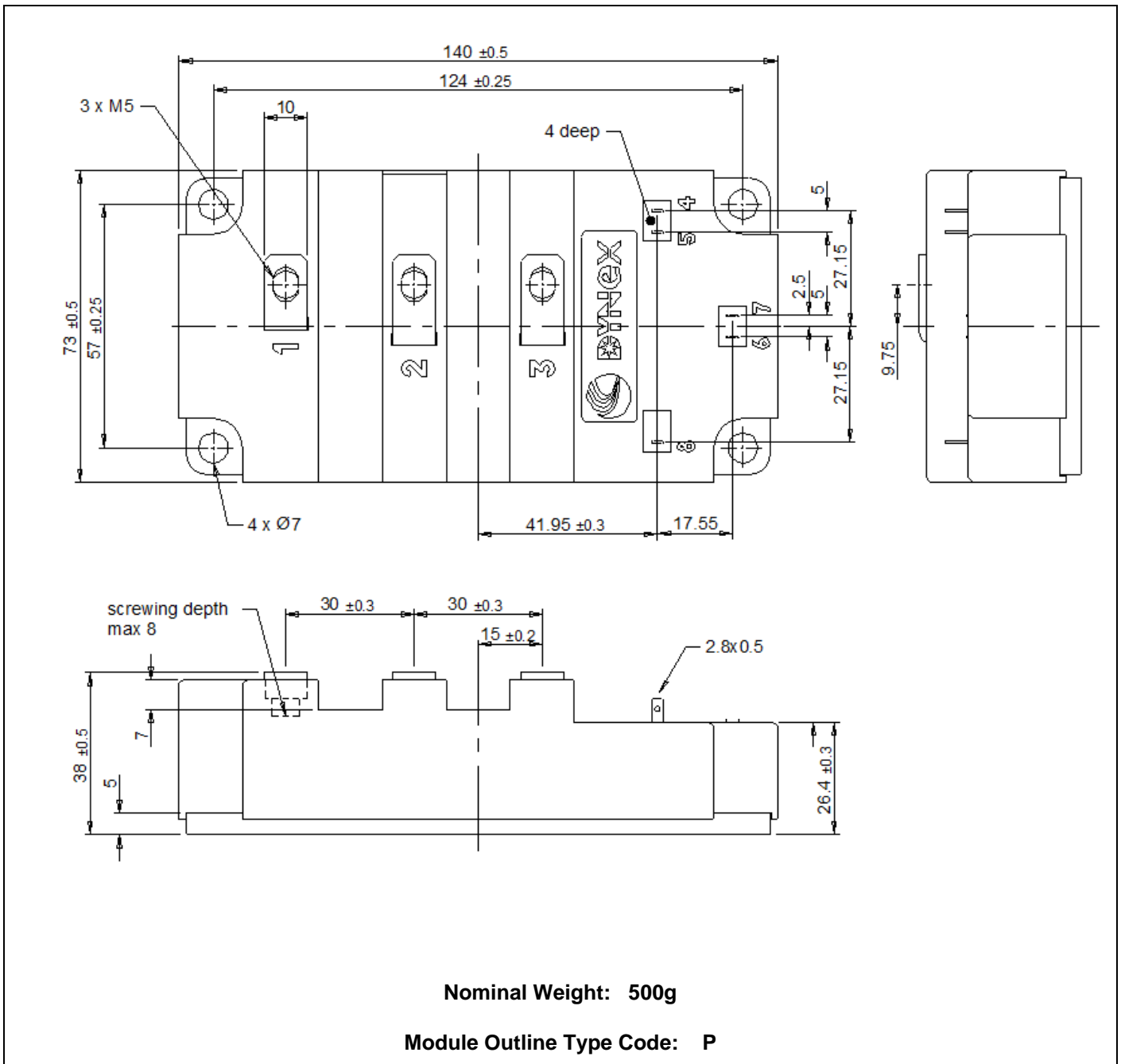

Fig. 10 Transient thermal impedance

PACKAGE DETAILS

For further package information, please visit our website or contact Customer Services.
 All dimensions in mm, unless stated otherwise.
DO NOT SCALE.



Nominal Weight: 500g

Module Outline Type Code: P

Fig. 11 Module outline drawing

IMPORTANT INFORMATION:

This publication is provided for information only and not for resale.

The products and information in this publication are intended for use by appropriately trained technical personnel.

Due to the diversity of product applications, the information contained herein is provided as a general guide only and does not constitute any guarantee of suitability for use in a specific application. The user must evaluate the suitability of the product and the completeness of the product data for the application. The user is responsible for product selection and ensuring all safety and any warning requirements are met. Should additional product information be needed please contact Customer Service.

Although we have endeavoured to carefully compile the information in this publication it may contain inaccuracies or typographical errors. The information is provided without any warranty or guarantee of any kind.

This publication is an uncontrolled document and is subject to change without notice. When referring to it please ensure that it is the most up to date version and has not been superseded.

The products are not intended for use in applications where a failure or malfunction may cause loss of life, injury or damage to property. The user must ensure that appropriate safety precautions are taken to prevent or mitigate the consequences of a product failure or malfunction.

The products must not be touched when operating because there is a danger of electrocution or severe burning. Always use protective safety equipment such as appropriate shields for the product and wear safety glasses. Even when disconnected any electric charge remaining in the product must be discharged and allowed to cool before safe handling using protective gloves.

Extended exposure to conditions outside the product ratings may affect reliability leading to premature product failure. Use outside the product ratings is likely to cause permanent damage to the product. In extreme conditions, as with all semiconductors, this may include potentially hazardous rupture, a large current to flow or high voltage arcing, resulting in fire or explosion. Appropriate application design and safety precautions should always be followed to protect persons and property.

Product Status & Product Ordering:

We annotate datasheets in the top right hand corner of the front page, to indicate product status if it is not yet fully approved for production. The annotations are as follows:-

Target Information:	This is the most tentative form of information and represents a very preliminary specification. No actual design work on the product has been started.
Preliminary Information:	The product design is complete and final characterisation for volume production is in progress. The datasheet represents the product as it is now understood but details may change.
No Annotation:	The product has been approved for production and unless otherwise notified by Dynex any product ordered will be supplied to the current version of the data sheet prevailing at the time of our order acknowledgement.

All products and materials are sold and services provided subject to Dynex's conditions of sale, which are available on request.

Any brand names and product names used in this publication are trademarks, registered trademarks or trade names of their respective owners.

HEADQUARTERS OPERATIONS

DYNEX SEMICONDUCTOR LTD

Doddington Road, Lincoln, Lincolnshire, LN6 3LF,
United Kingdom

Fax: +44(0)1522 500550

Tel: +44(0)1522 500500

Web: <http://www.dynexsemi.com>

CUSTOMER SERVICE

DYNEX SEMICONDUCTOR LTD

Doddington Road, Lincoln, Lincolnshire, LN6 3LF,
United Kingdom

Fax: +44(0)1522 500020

Tel: +44(0)1522 502753 / 502901

Email: Power_solutions@dynexsemi.com